

Bucket Bag

Patroondelen / Pièces du patron / Pattern pieces / Schnittteile:

- A** bodem / fond / bottom / Boden
- B** wand stof / paroi / outer fabric /
Stoff für den Taschenkörper
- C** wand voering / paroi doublure / inner
lining / Futter für den Taschenkörper
- D** zak voering / poche doublure /
pocket lining / Taschenfutter
- E** beleg / parementure / facing / Besatz
- F** schouderlint kort / bandoulière
courte / short shoulder strap /
kurzer Trageriemen
- G** schouderlint lang / bandoulière
longue / long shoulder strap /
langer Trageriemen
- H** stropertje / arrêt / cord stop /
Kordelstopper
- I** paspellint / ruban passepoil /
piping strip / Paspelband

Patroonschema / Schéma du Patron / Pattern Diagram / Übersichtsplan zum Zusammenkleben

1	2	3	4	5	6
7	8	9	10	11	12
13	14	15	16	17	18

Controlevierkant / Carré de controle / Test square / Kontrollquadrat

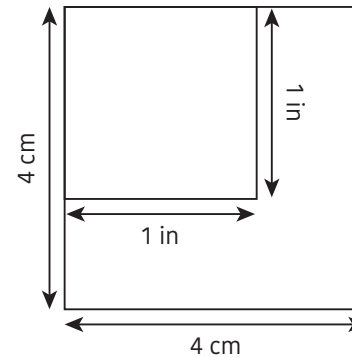

2

B

3

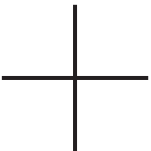
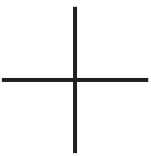

D



4

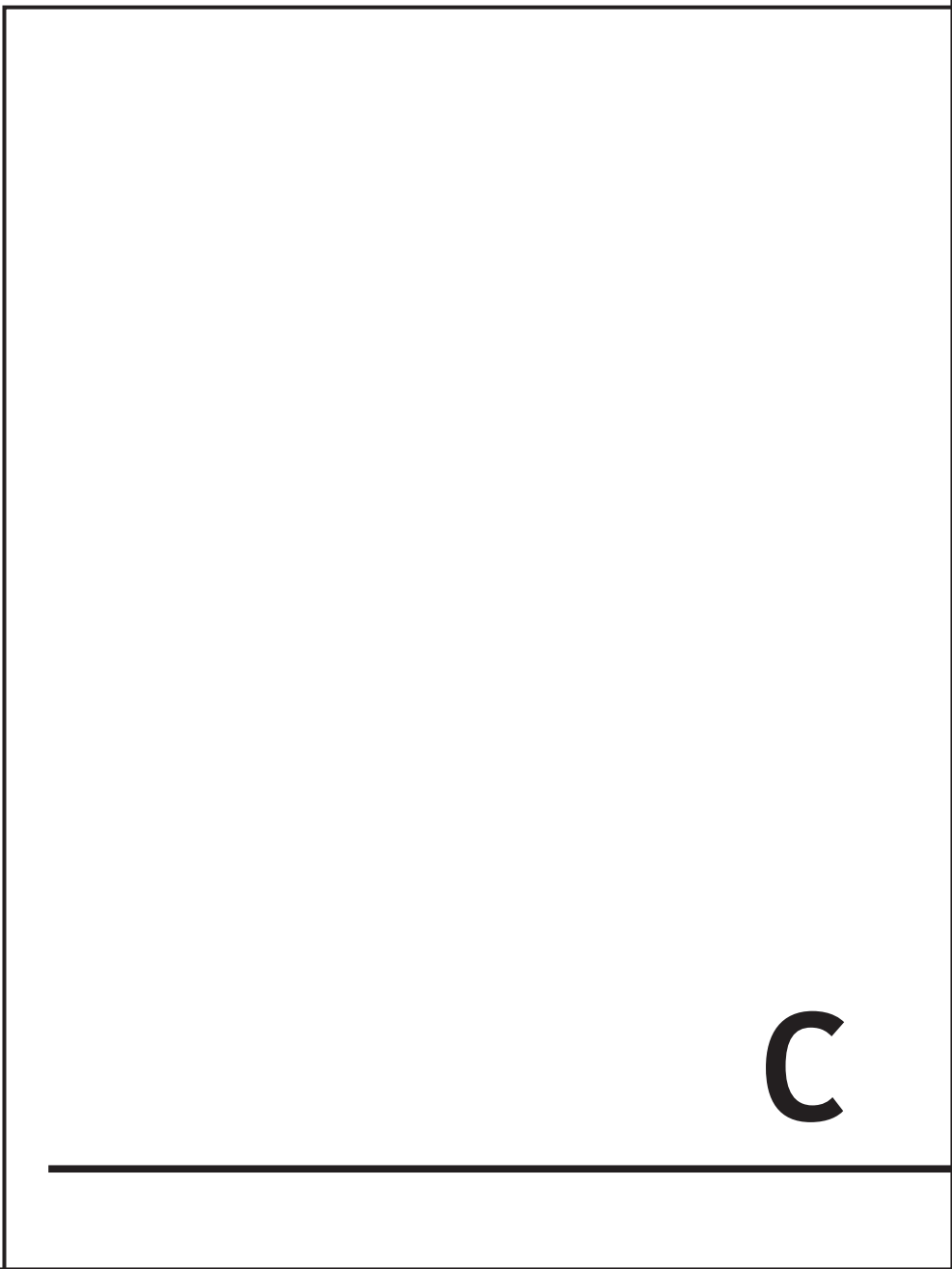
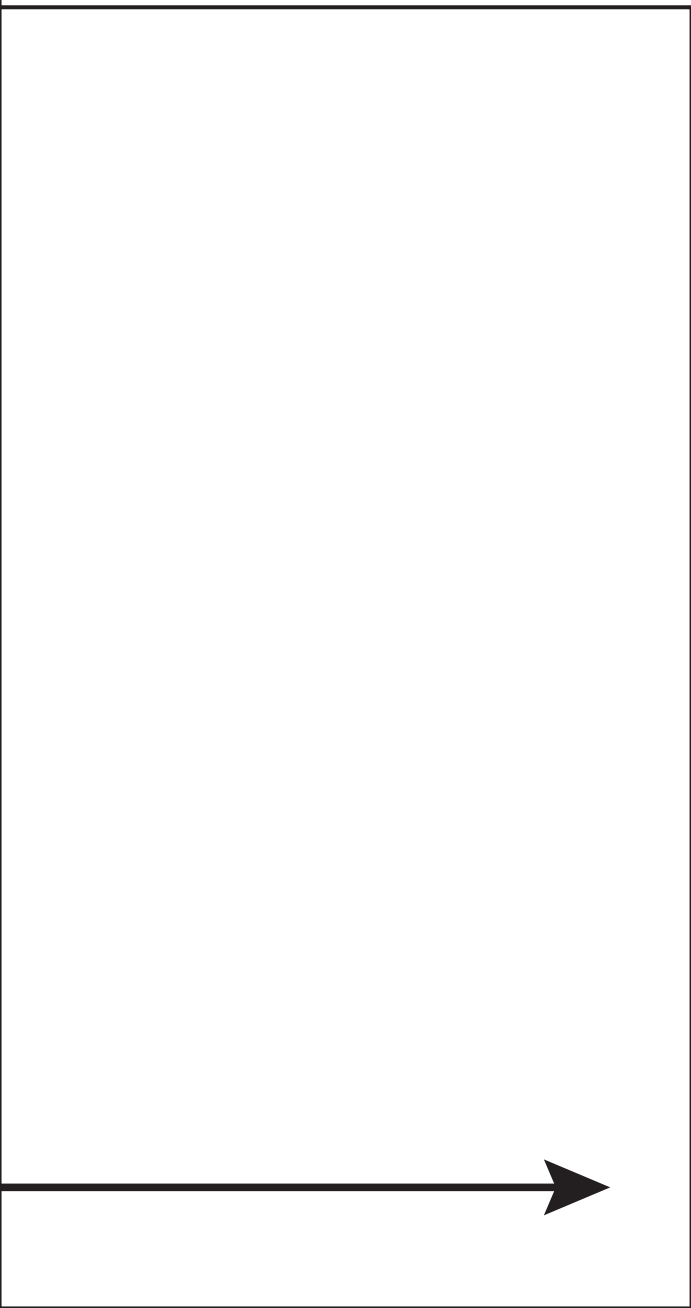

5

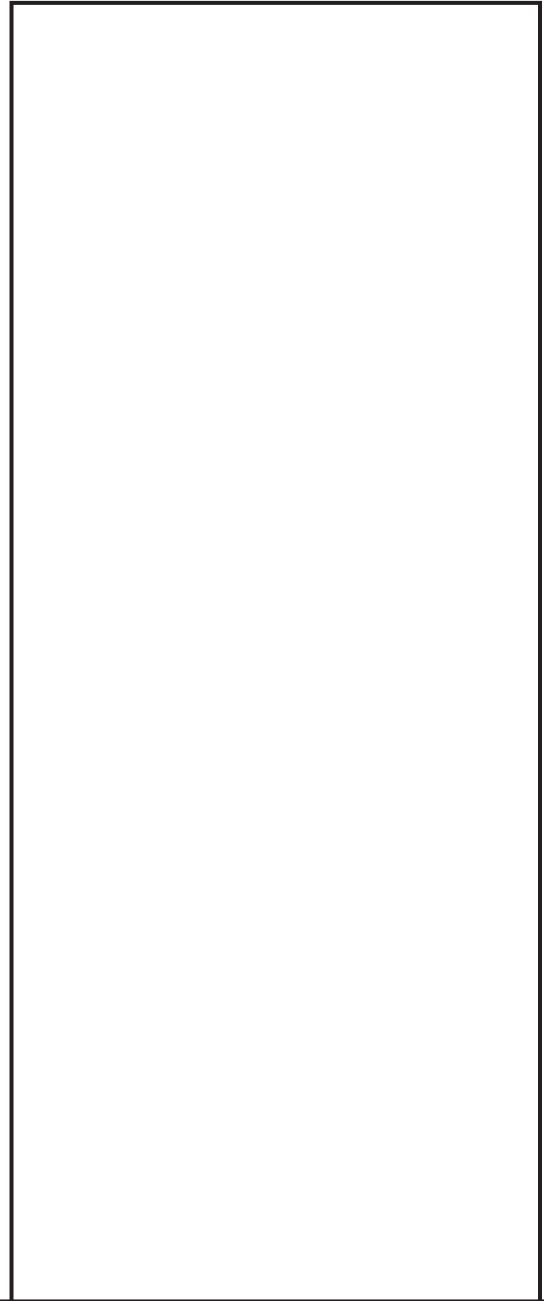
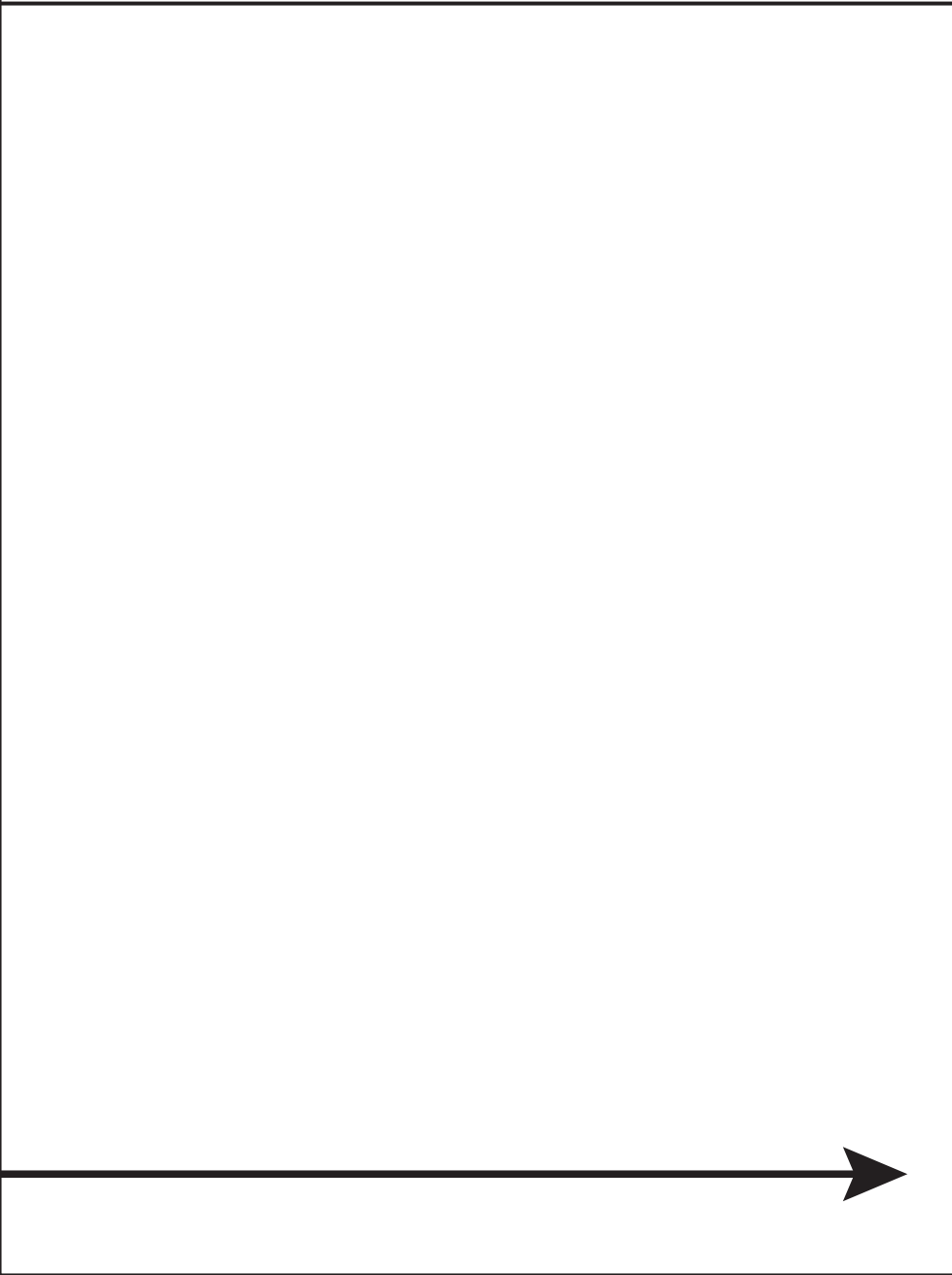

6

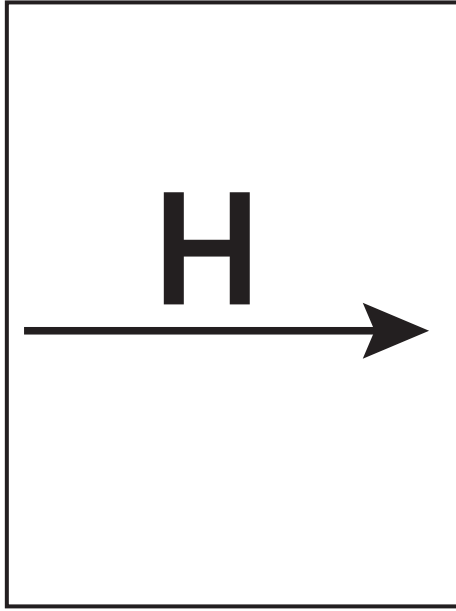
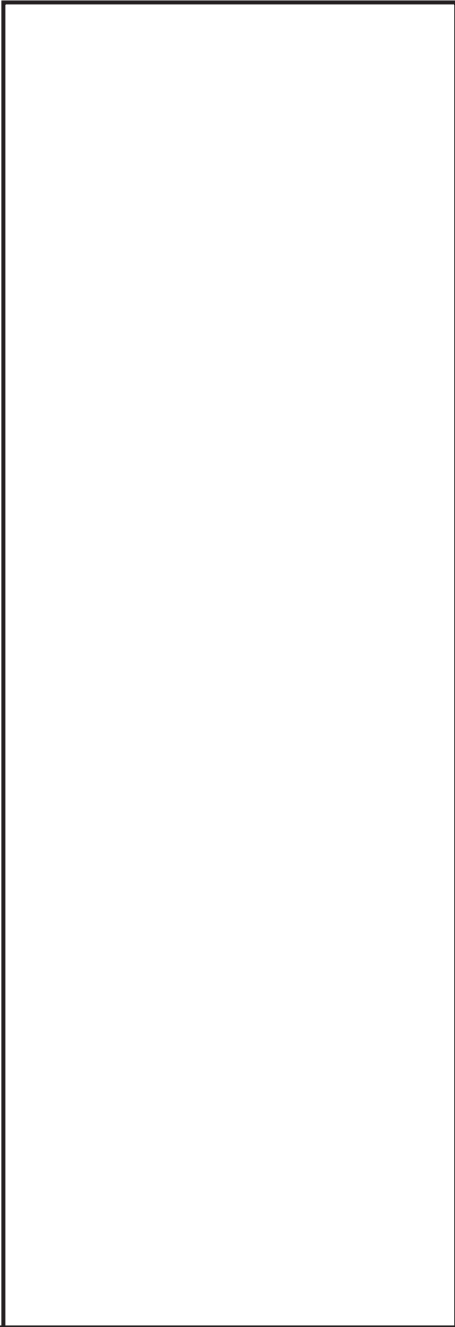

7

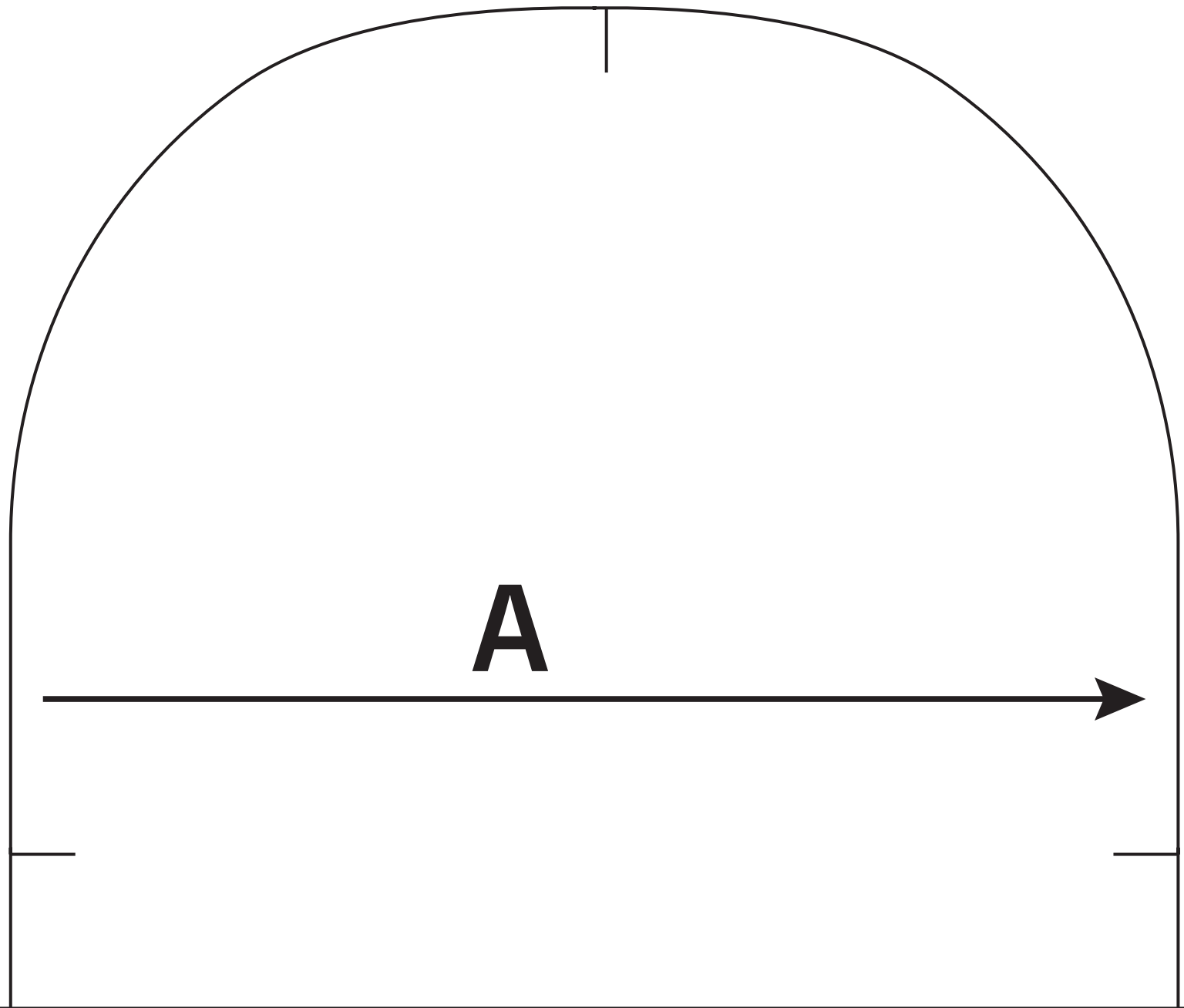

A

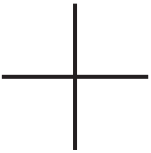
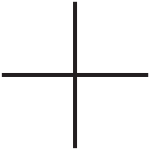



12



13

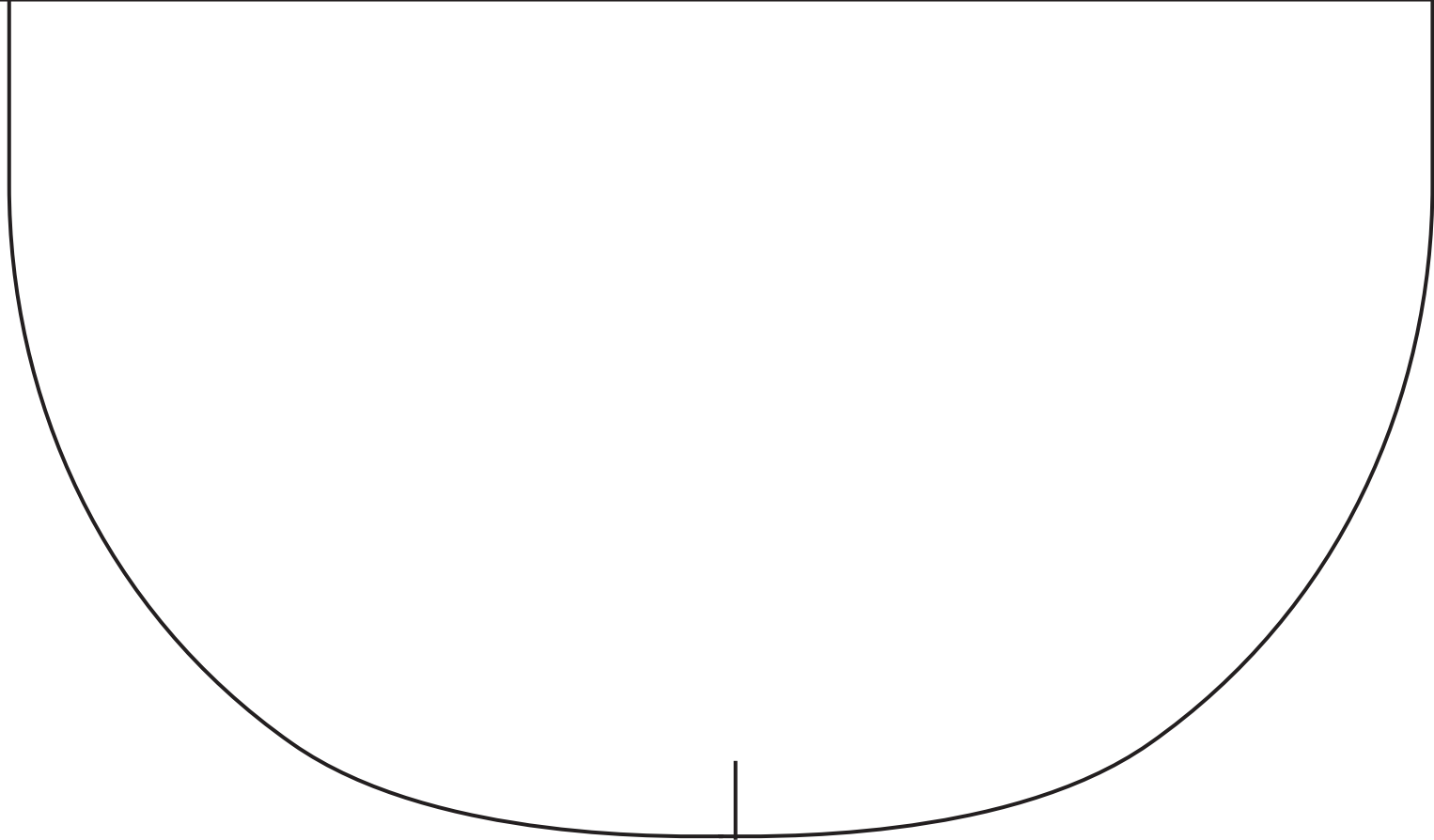

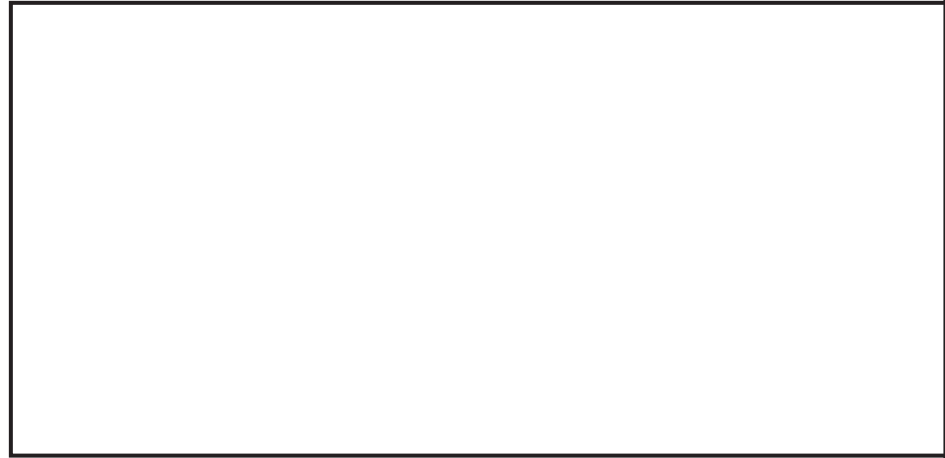

15

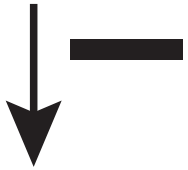

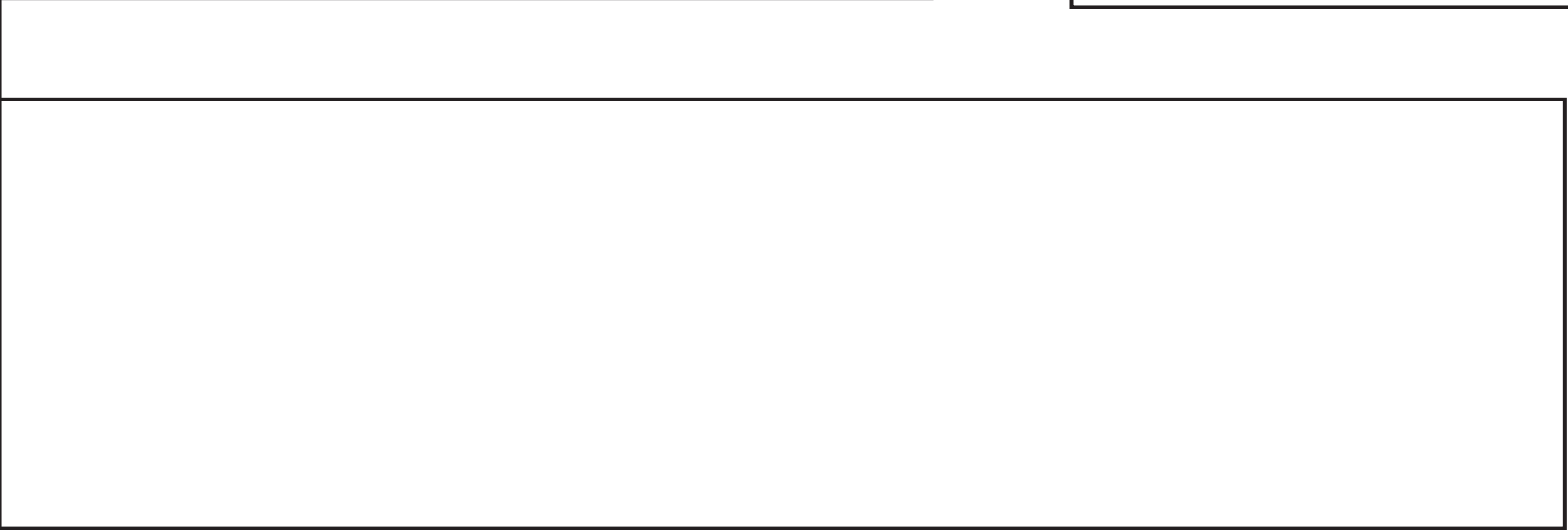
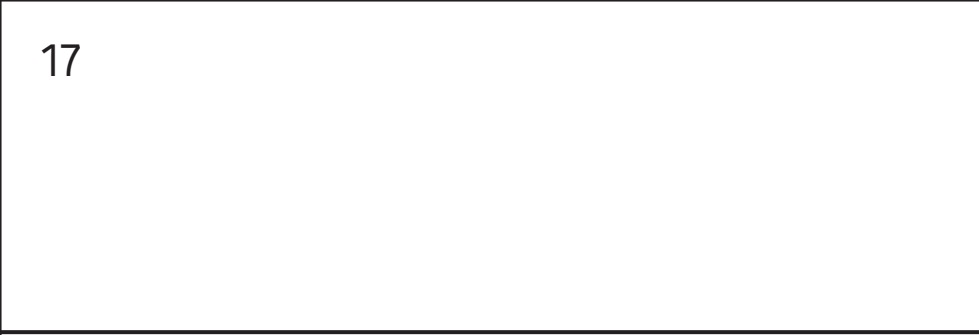

18

