

Elisa

Jurk / Robe /
Dress / Kleid

1

Maten / Tailles / Sizes / Größen:

.....	34
-----	36
-----	38
- - - - -	40
-----	42
-----	44
-----	46
-----	48
-----	50
-----	52
-----	54

Patroondelen / Parties du patron /
Pattern pieces / Schnittteile:

- A** Bovenstuk VP / Partie Supérieure
Du Devant / Top Piece FP /
Vorderteil oberes Teil
- B** VP Rok / Devant Jupe / Skirt FP /
Vorderteil Rock
- C** Schouderstuk / Patte D'épaule /
FP Shoulder Piece /
Schulterstück VT
- D** Halsboord VP / Bord Col Devant /
FP Collar Band / Halsbund VT
- E** Bovenstuk RP / Partie Supérieure
Du Dos / BP Top Section /
rückwärtiges Oberteil
- F** RP Rok / Dos Jupe / Skirt BP /
Rückenteil Rock
- G** Halsboord RP / Bord Col Dos /
Collar Band BP / Halsbund RT
- H** Mouw / Manche / Sleeve / Ärmel
- I** Riem / Ceinture / Belt / Gürtel

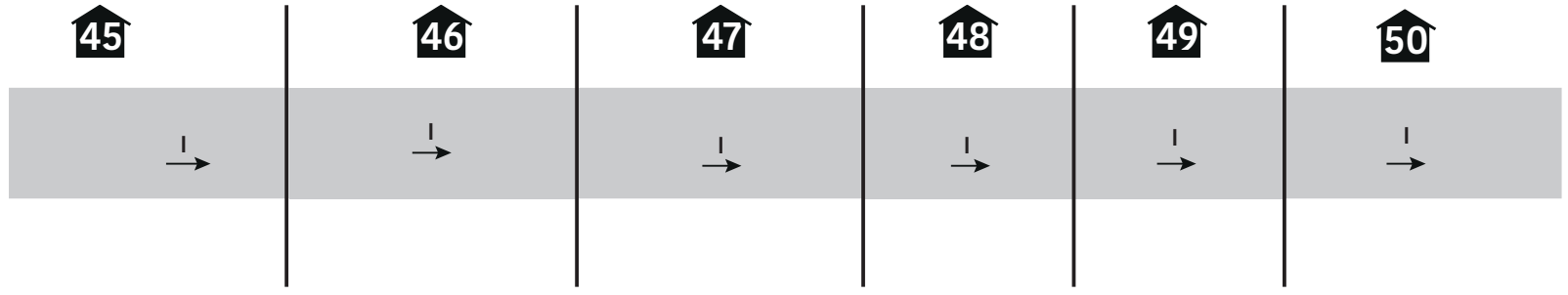
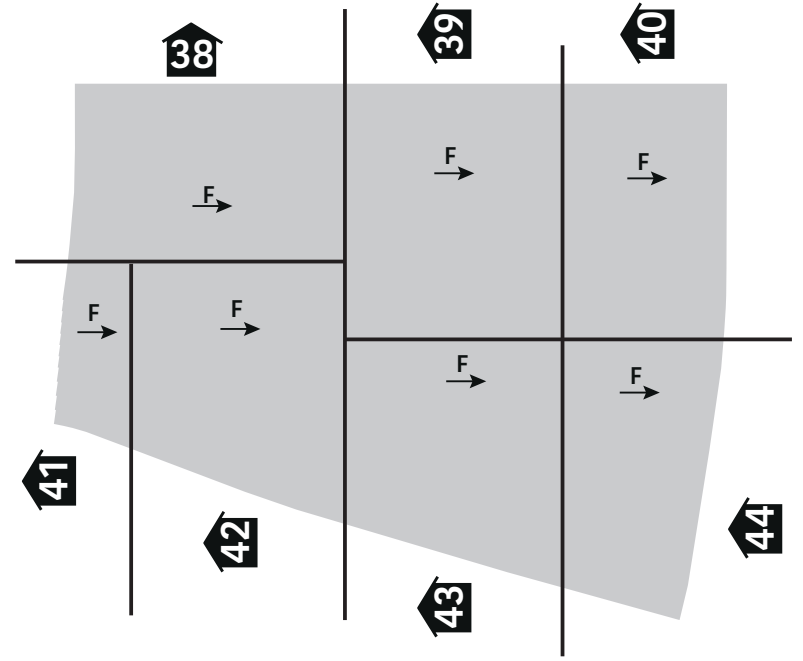
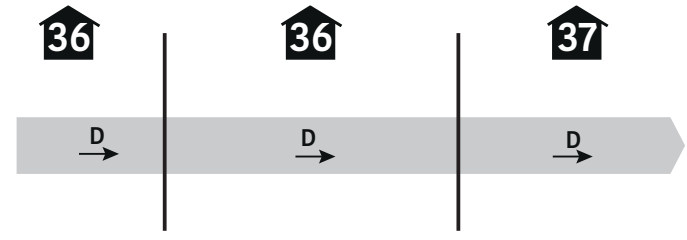
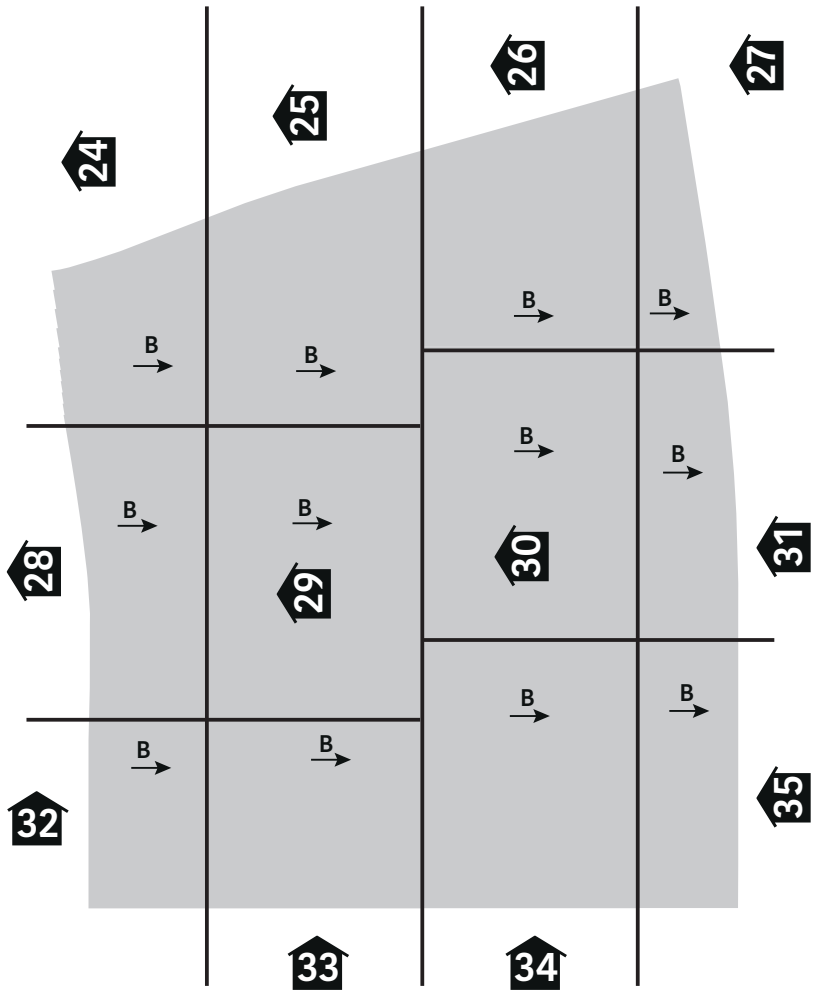

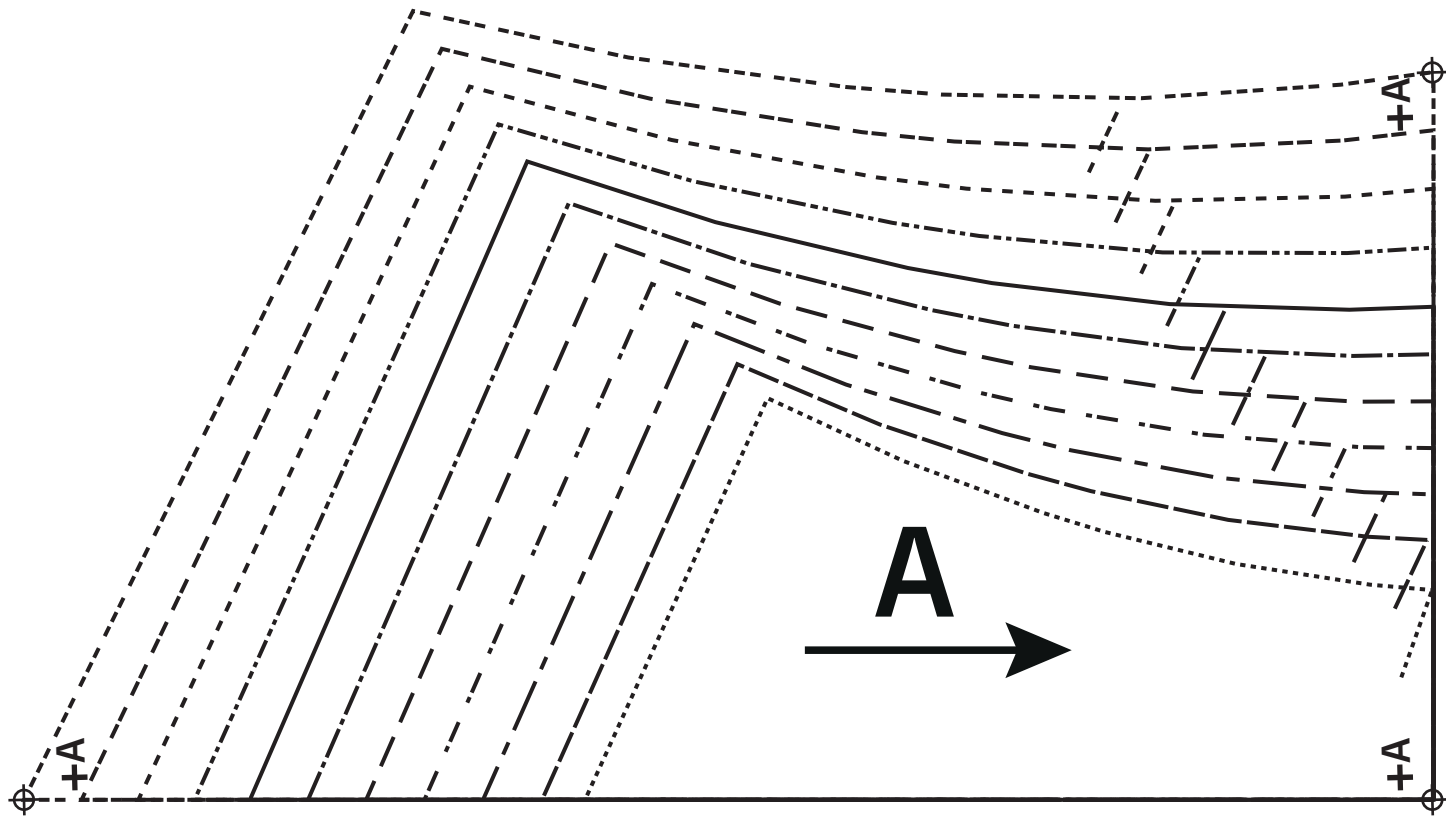

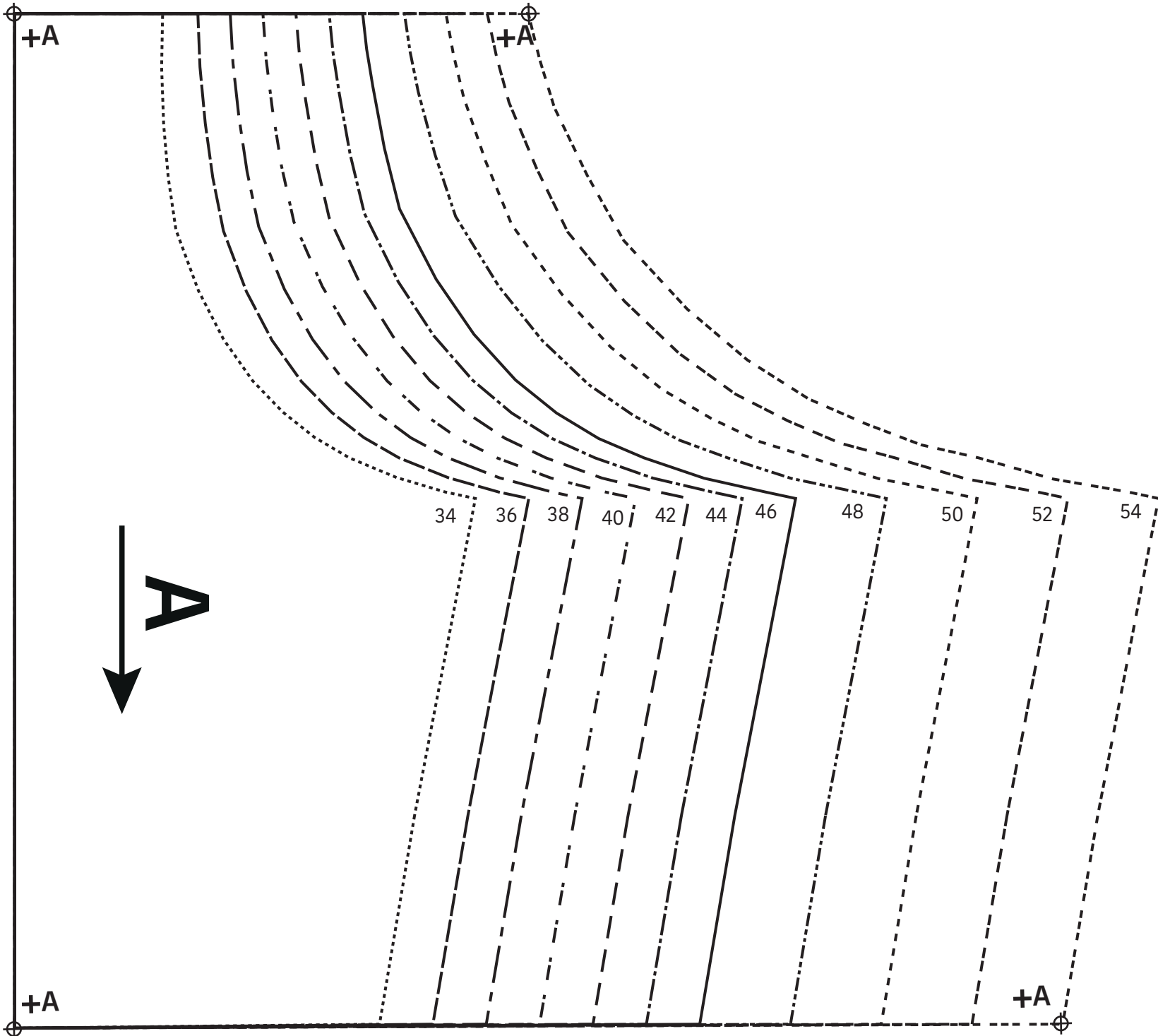

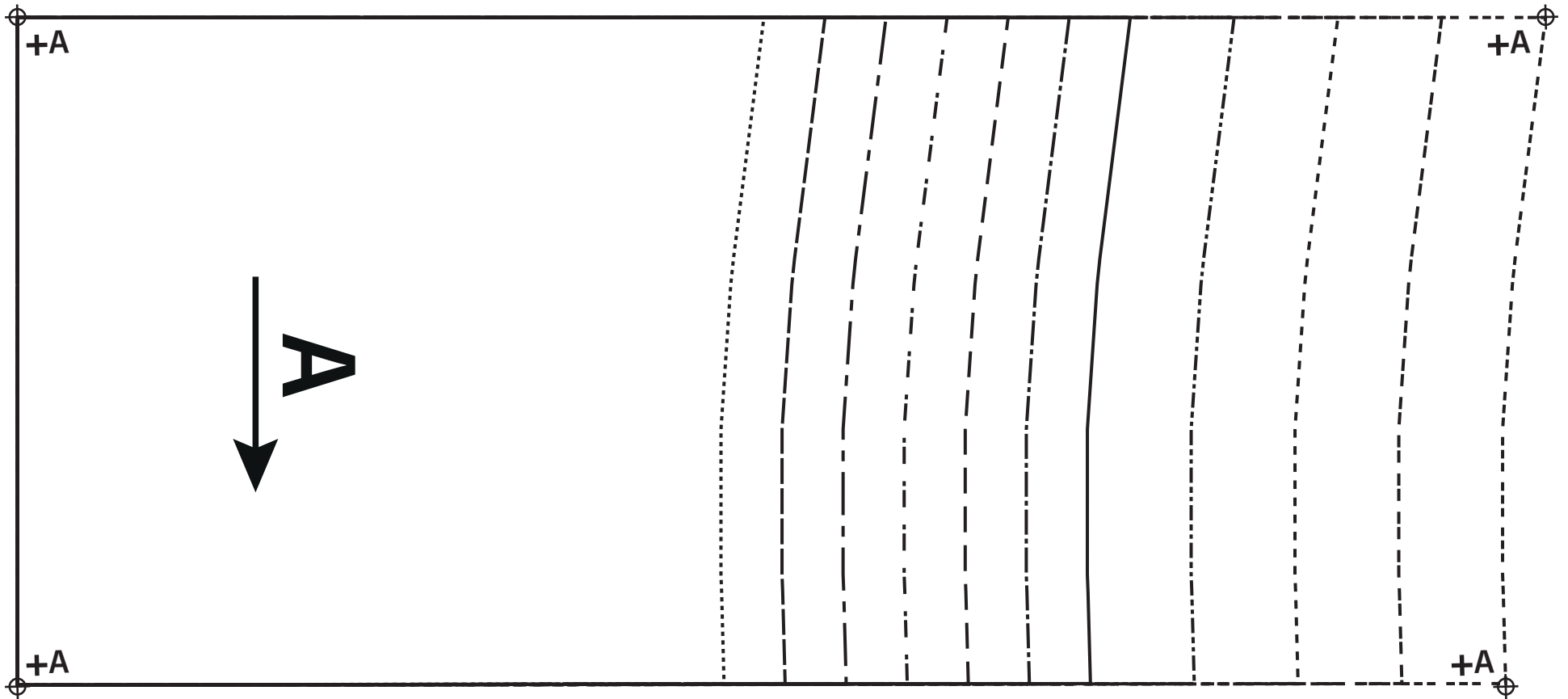

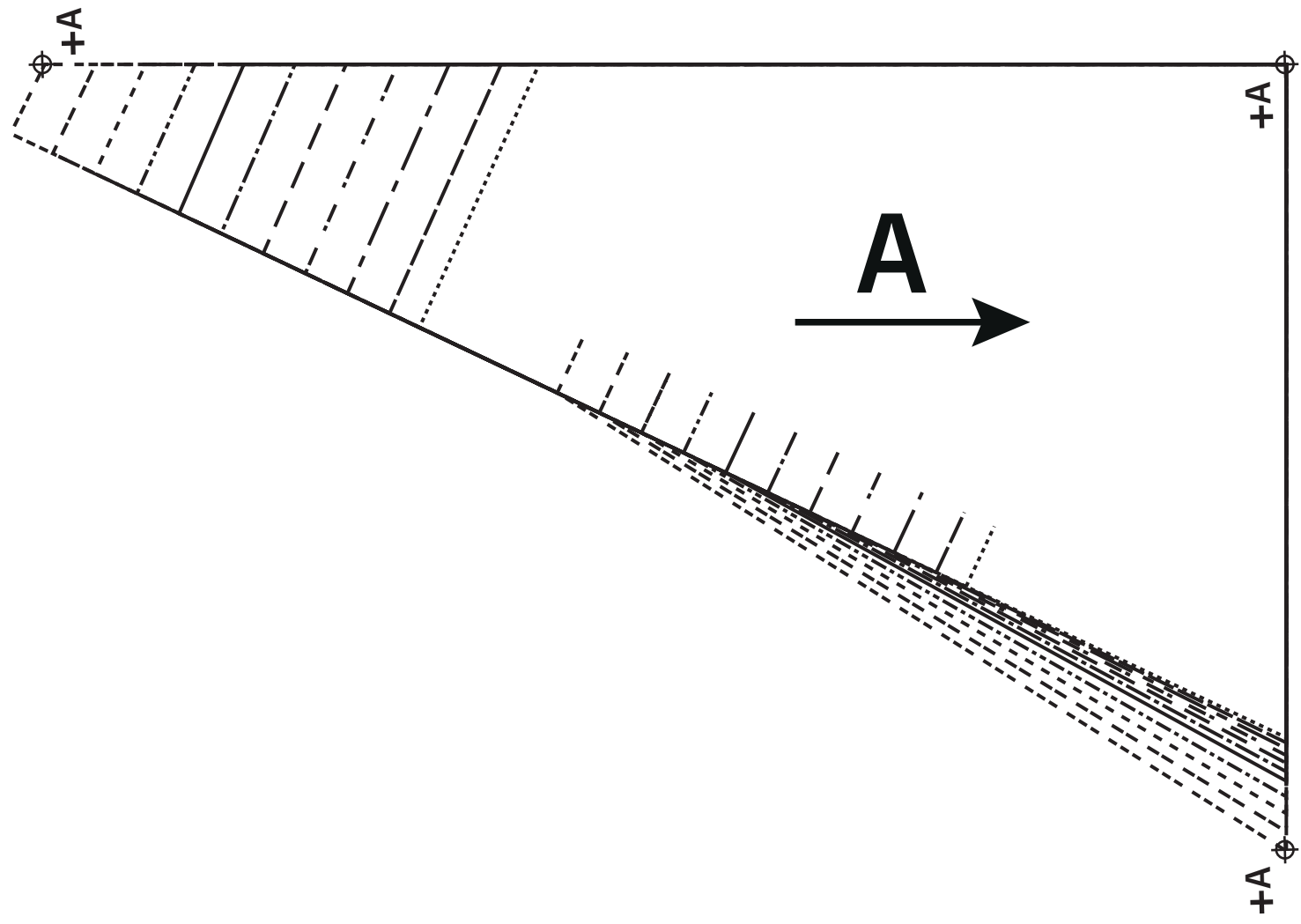

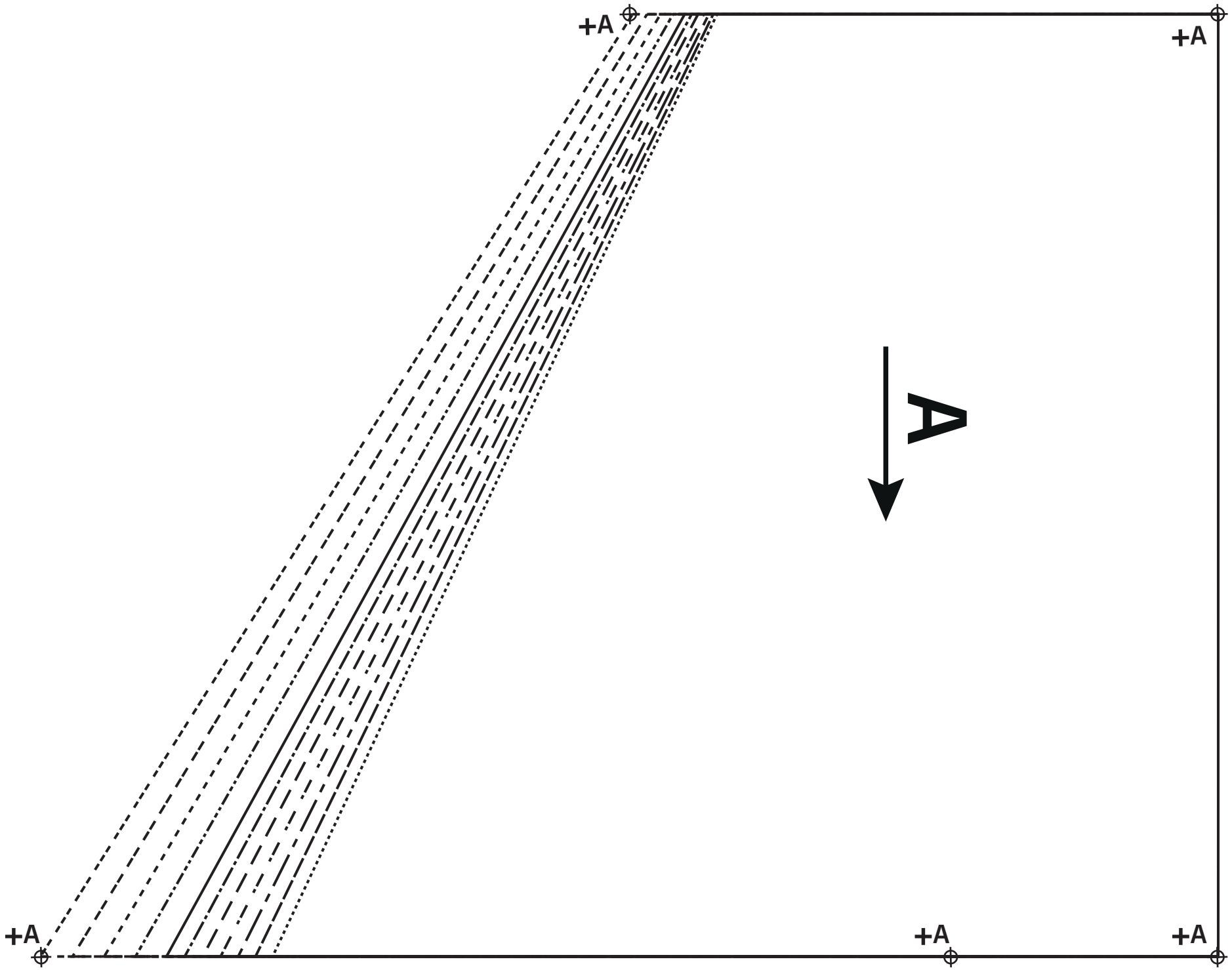

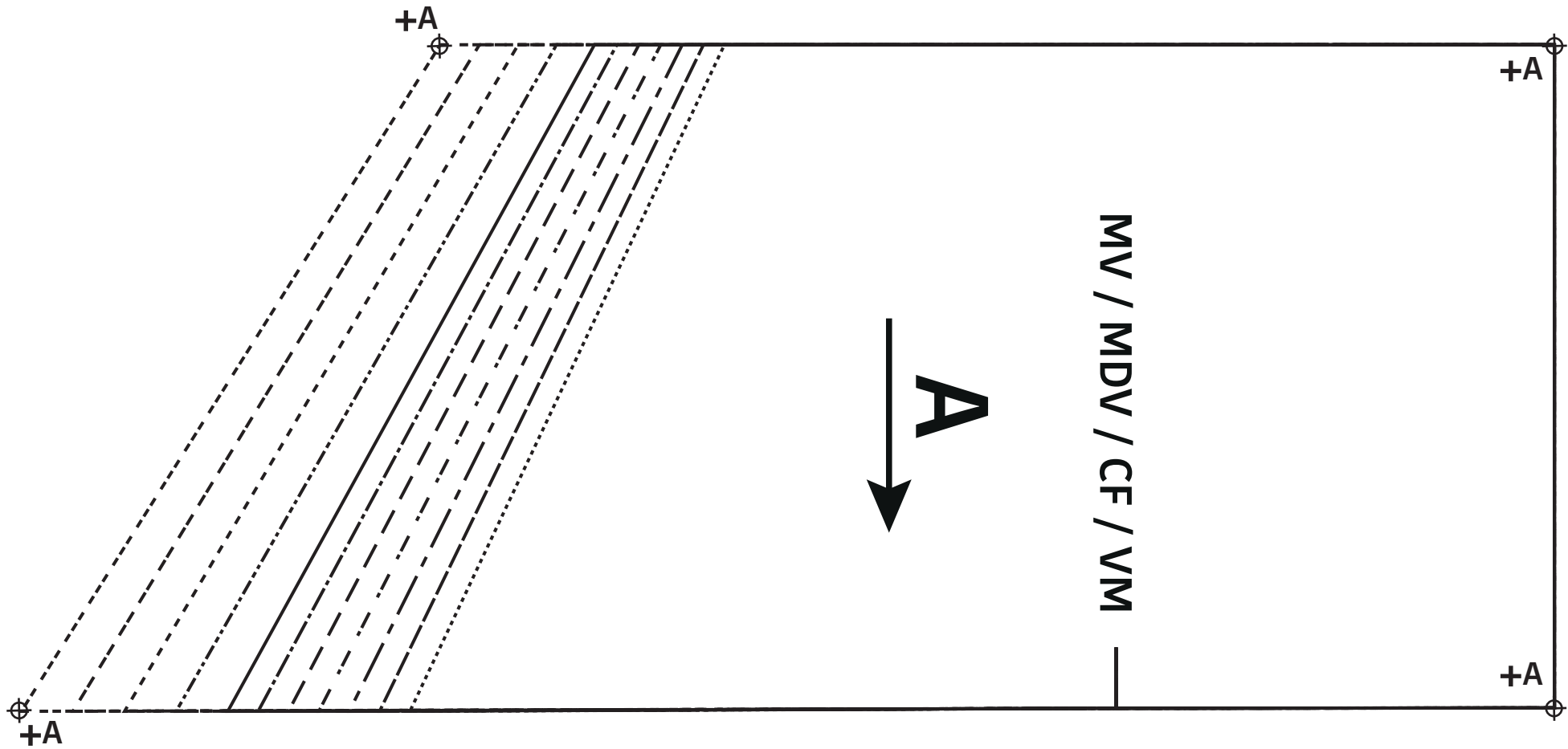

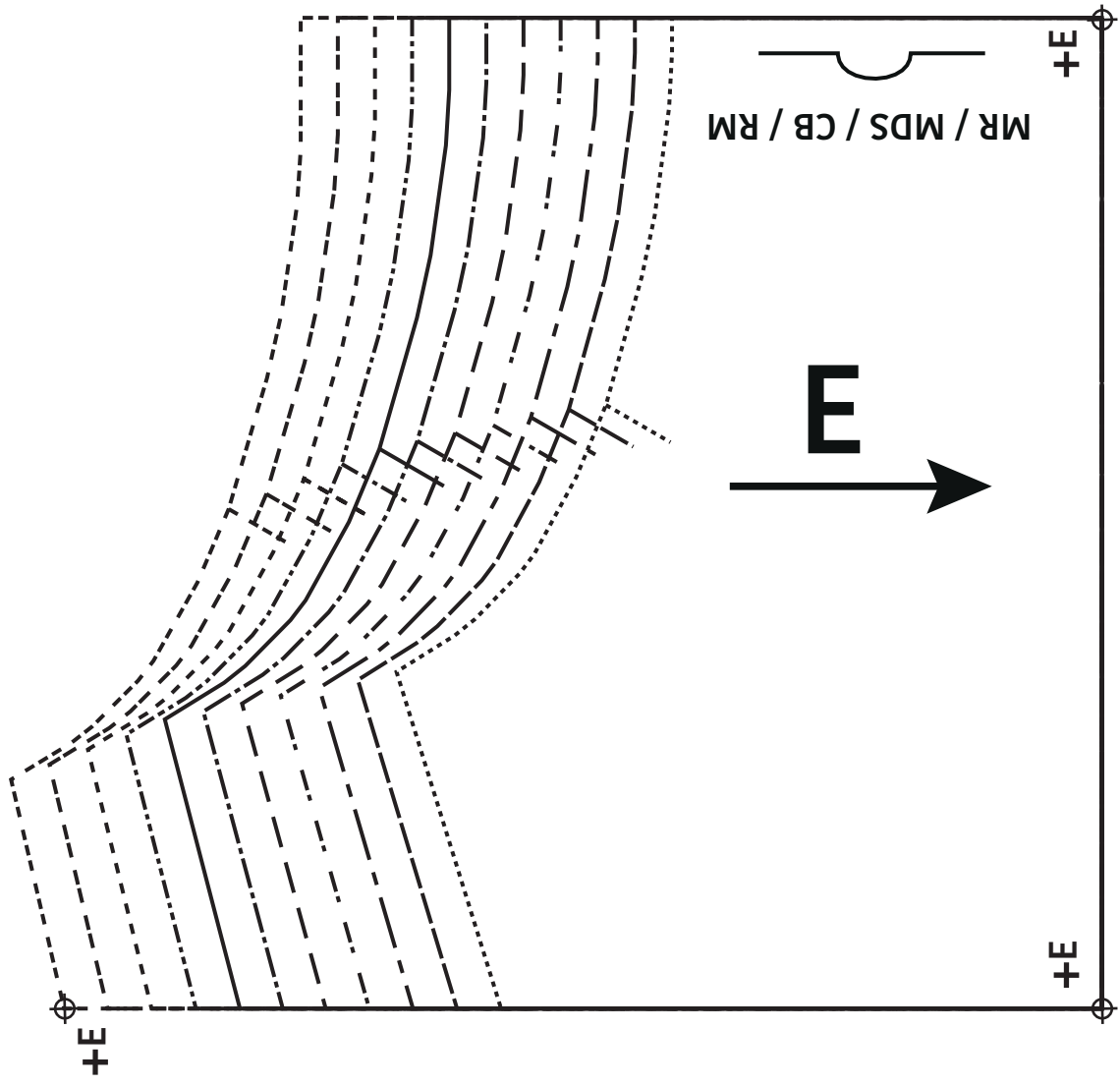

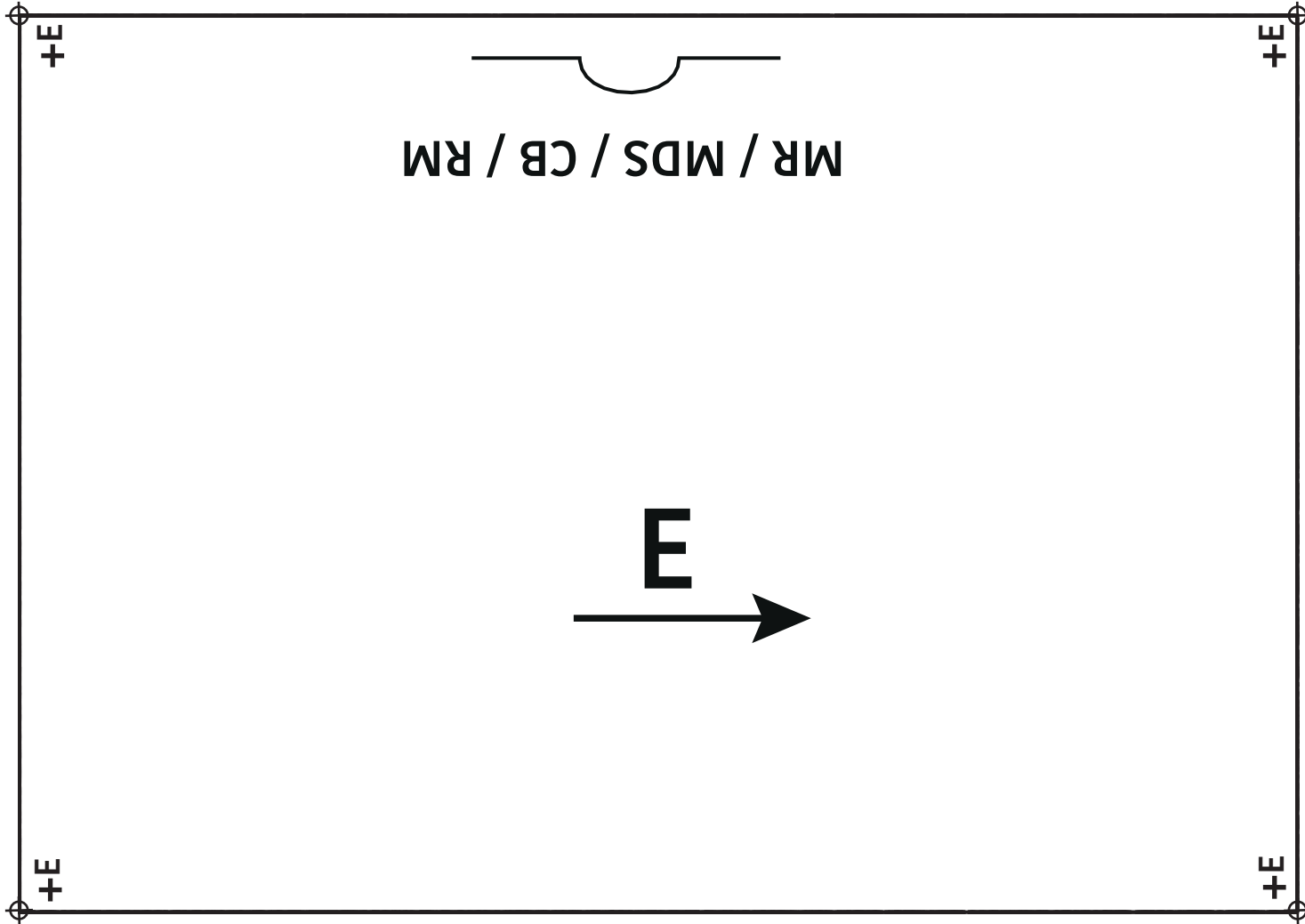

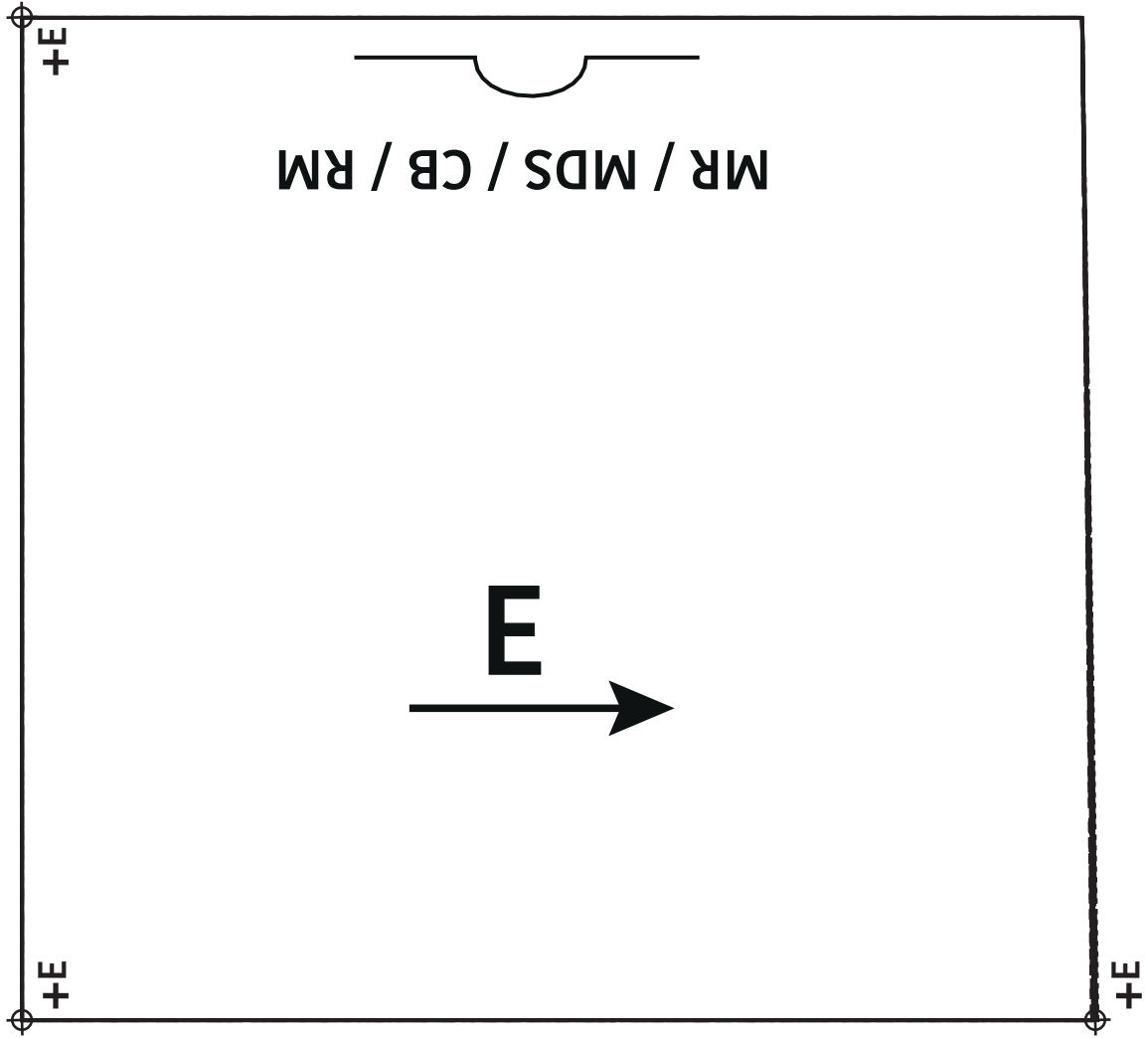

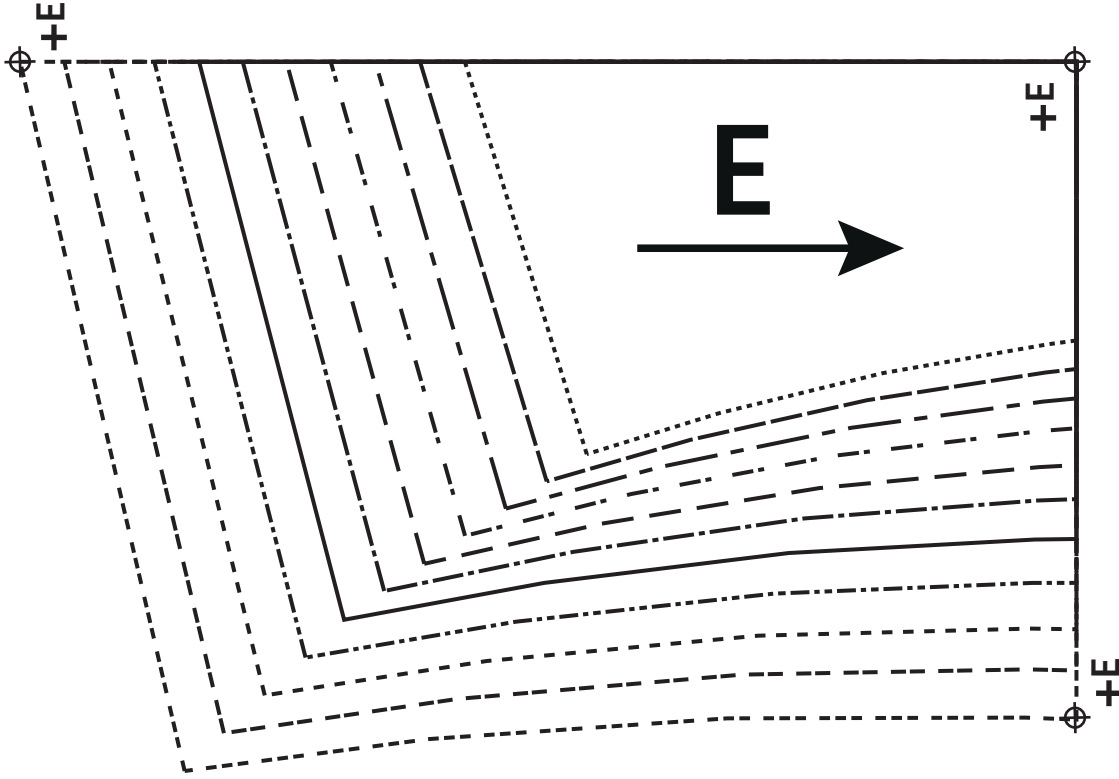

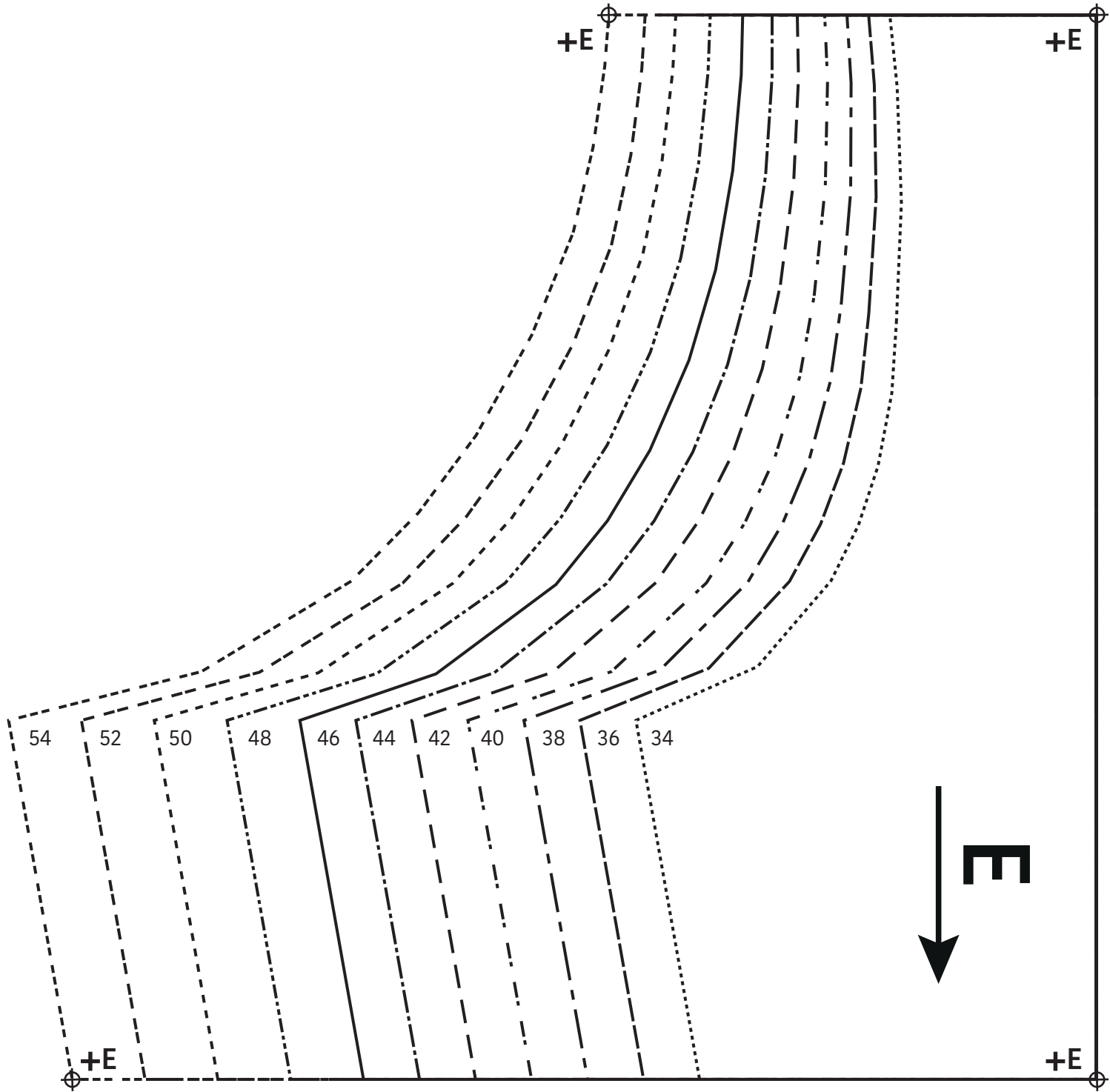

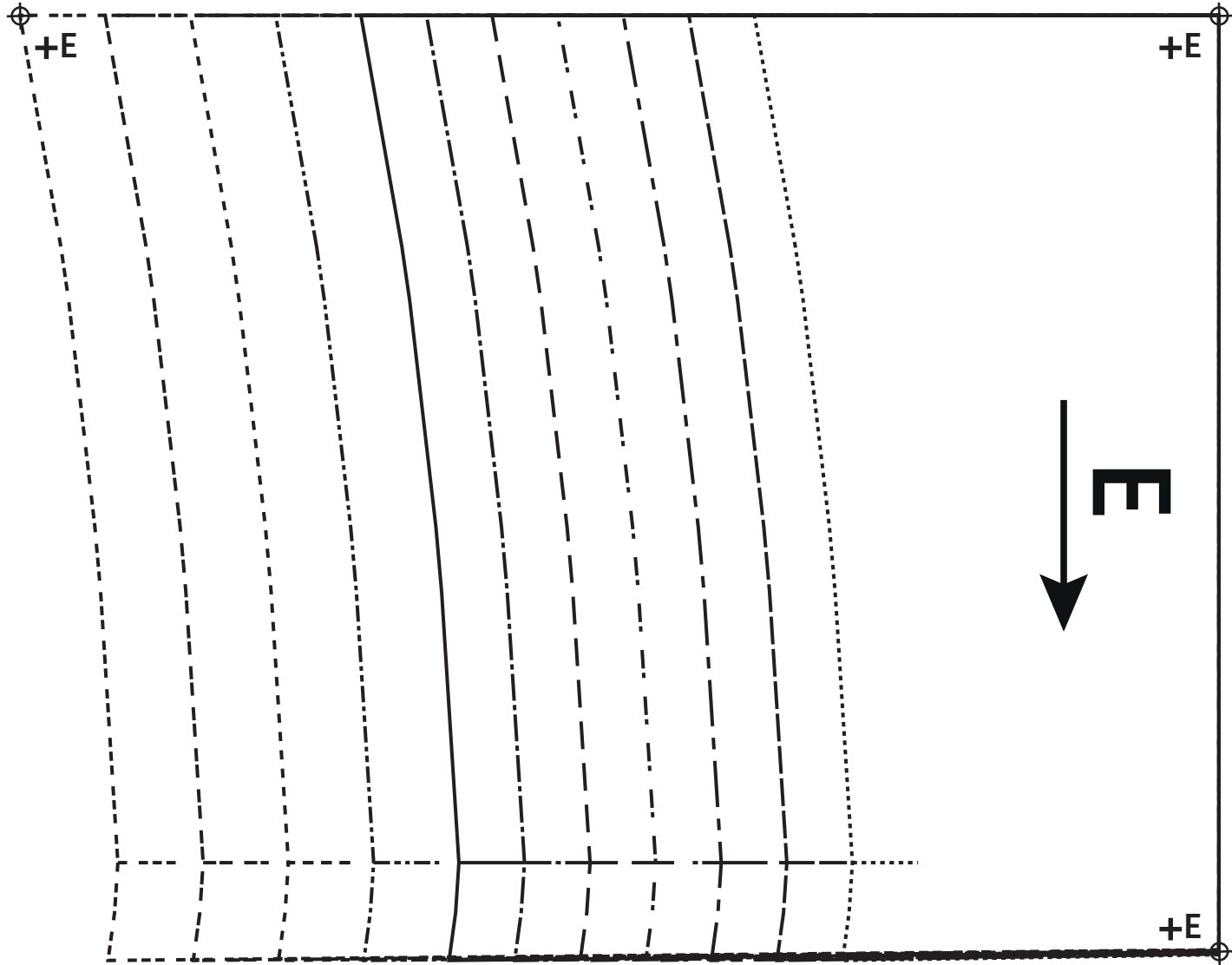

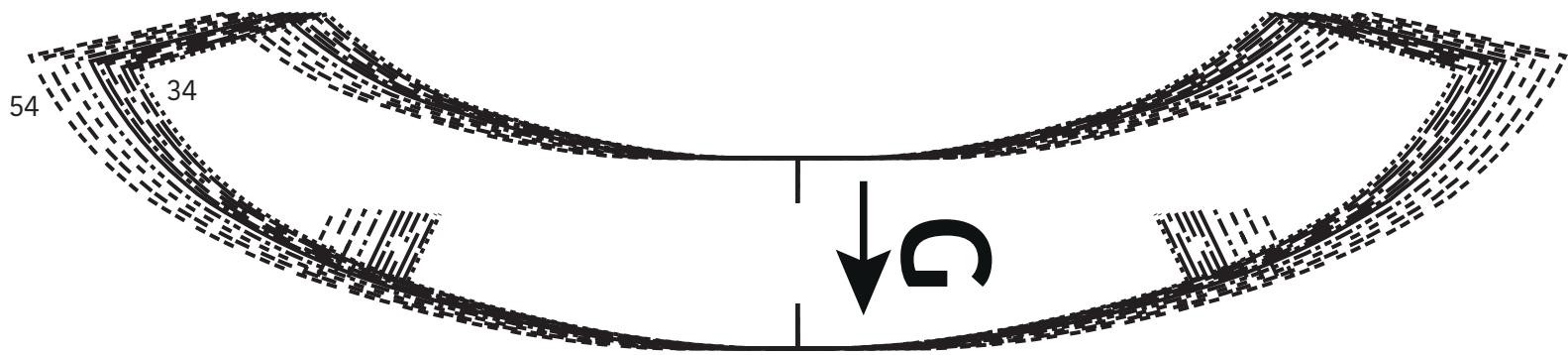

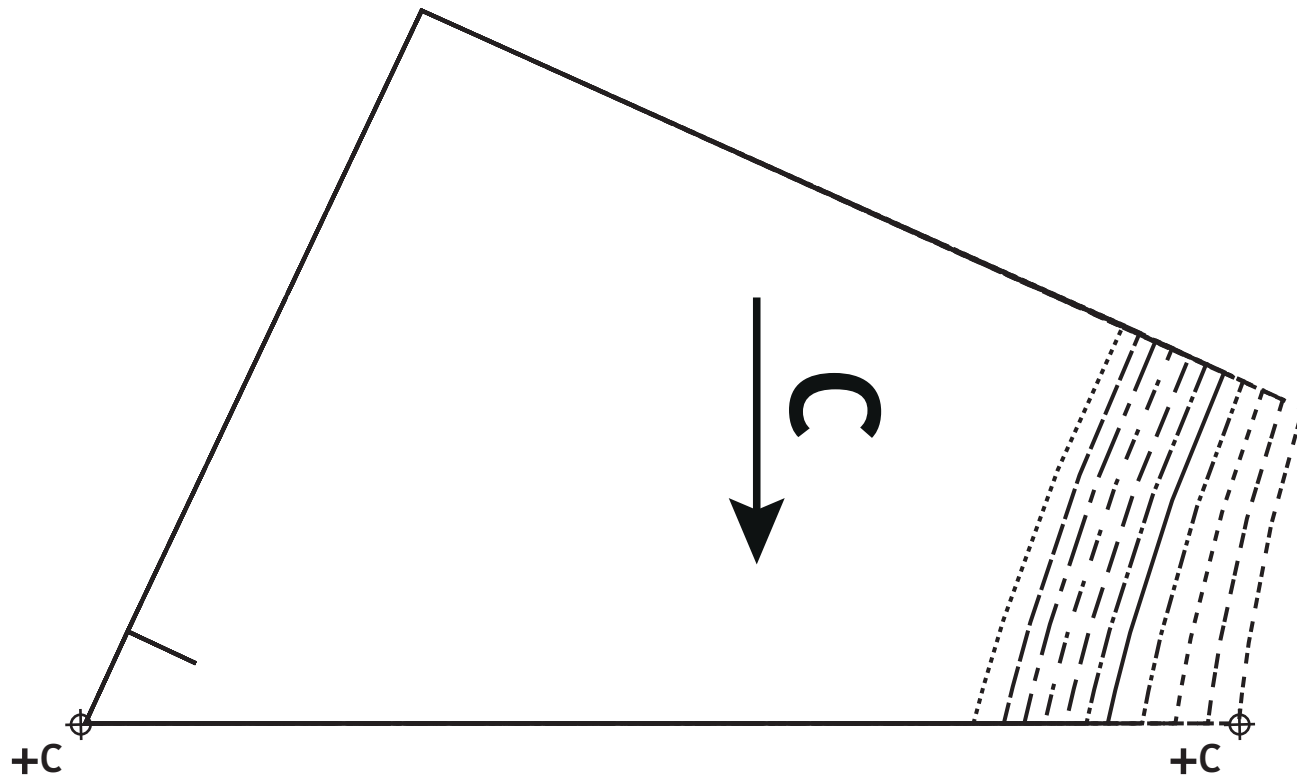

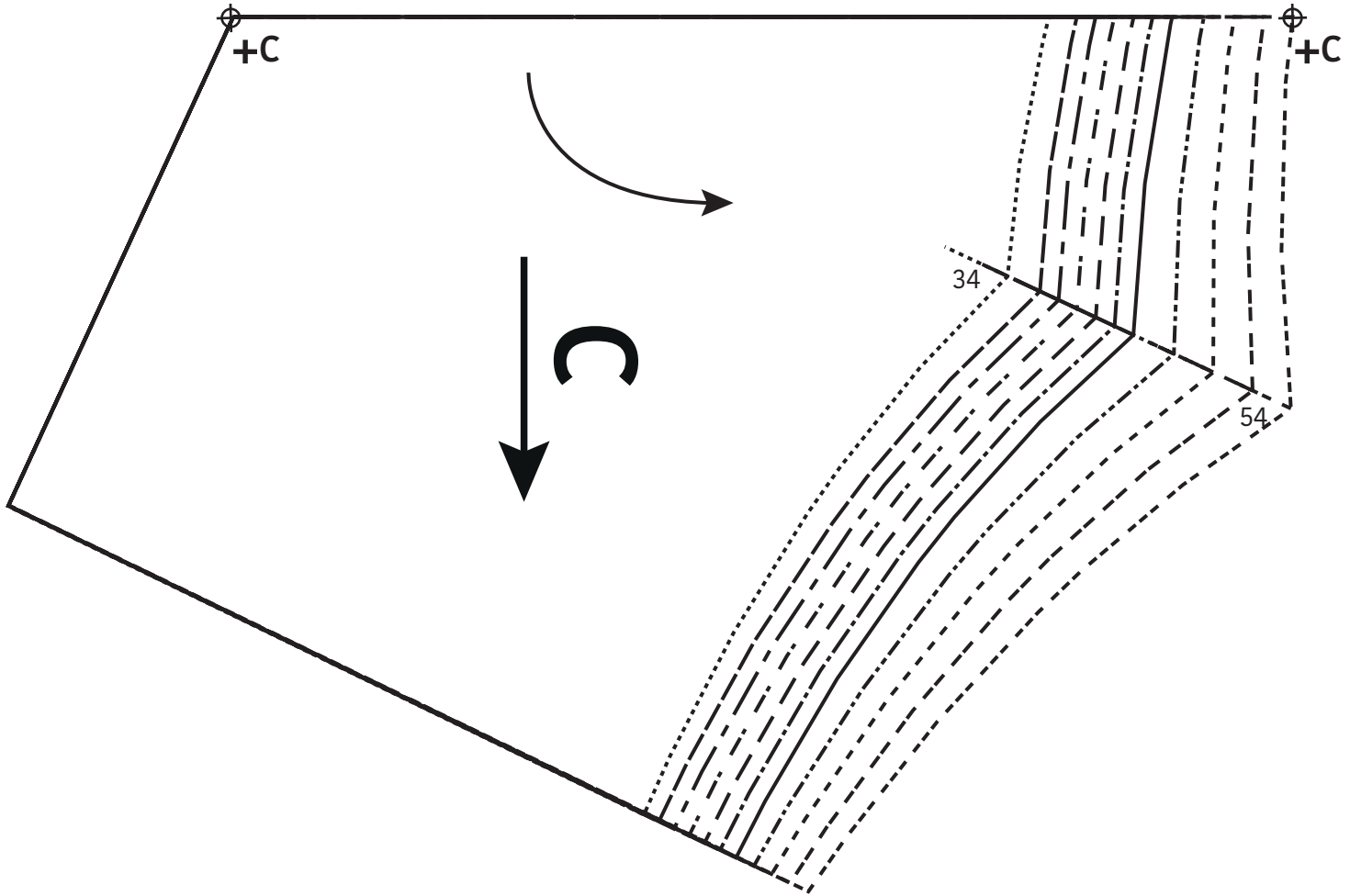

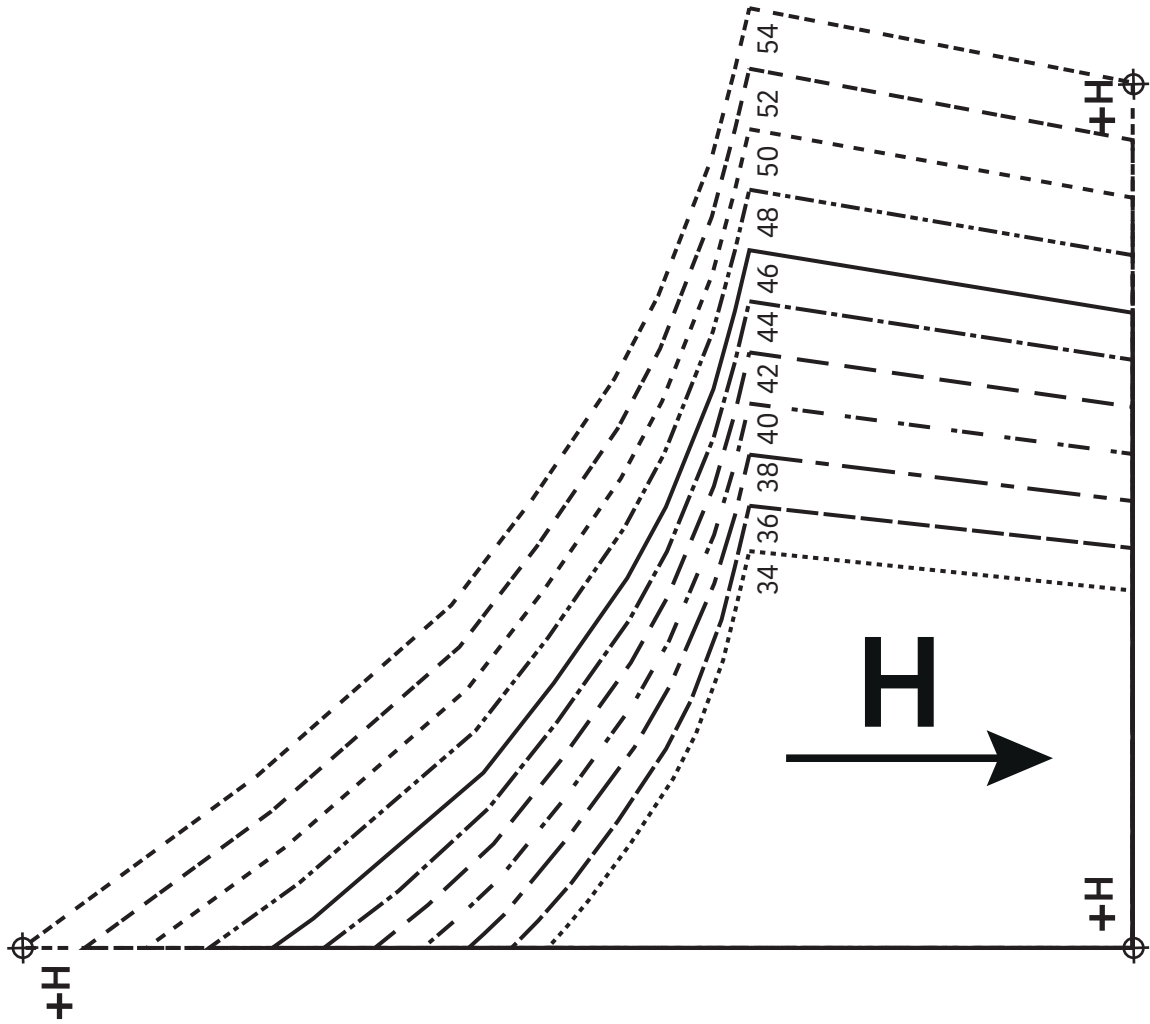

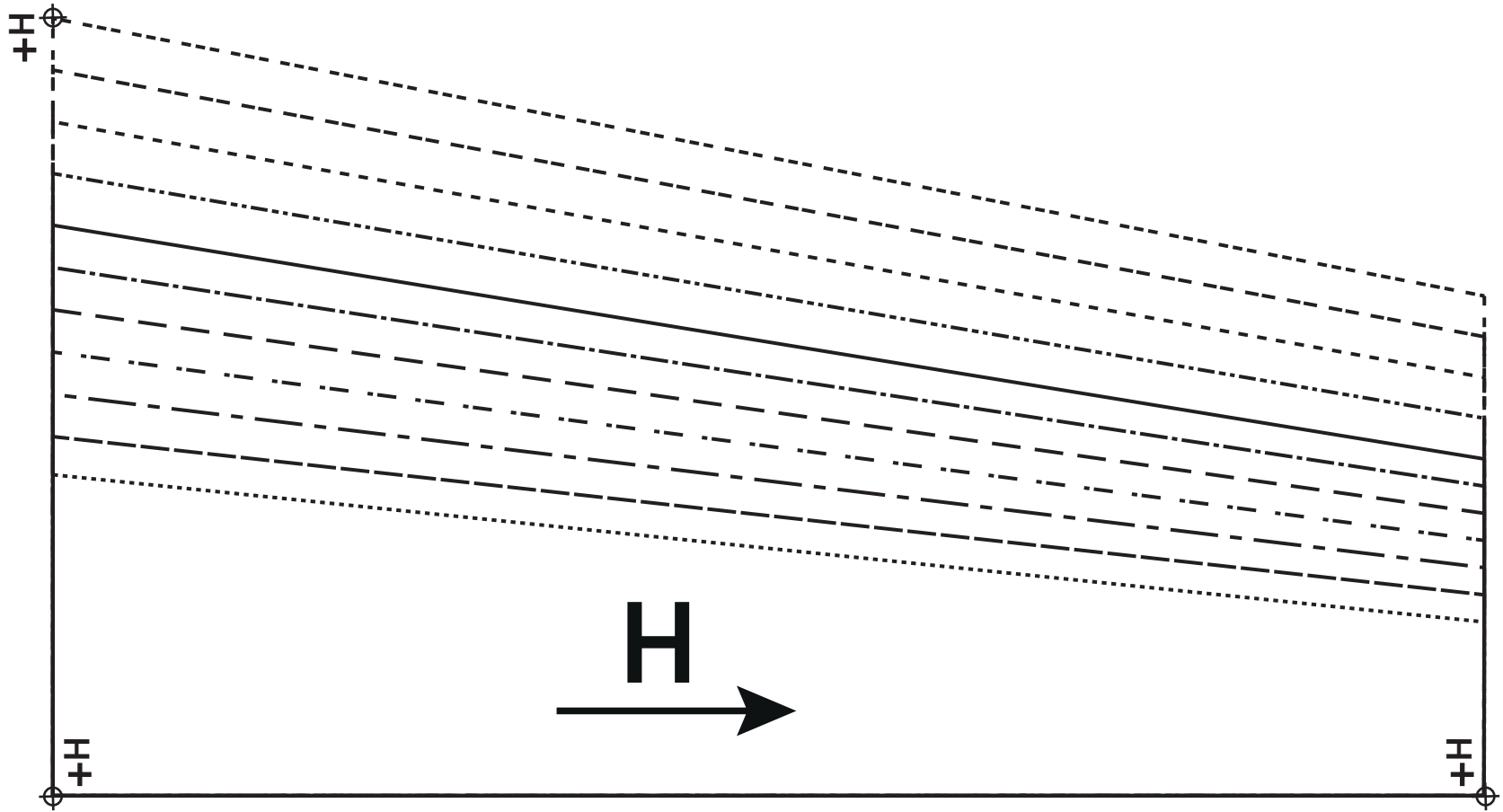

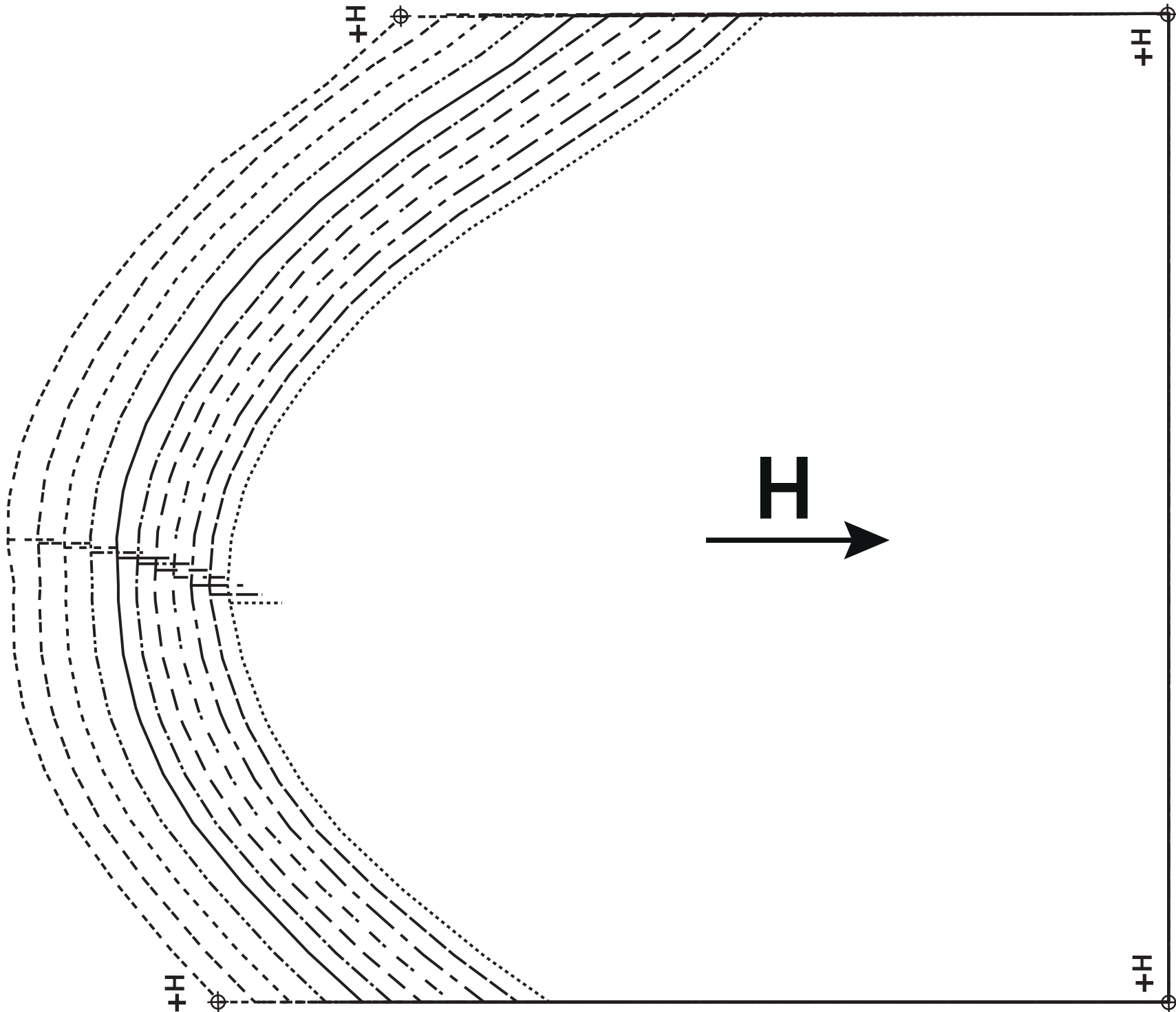

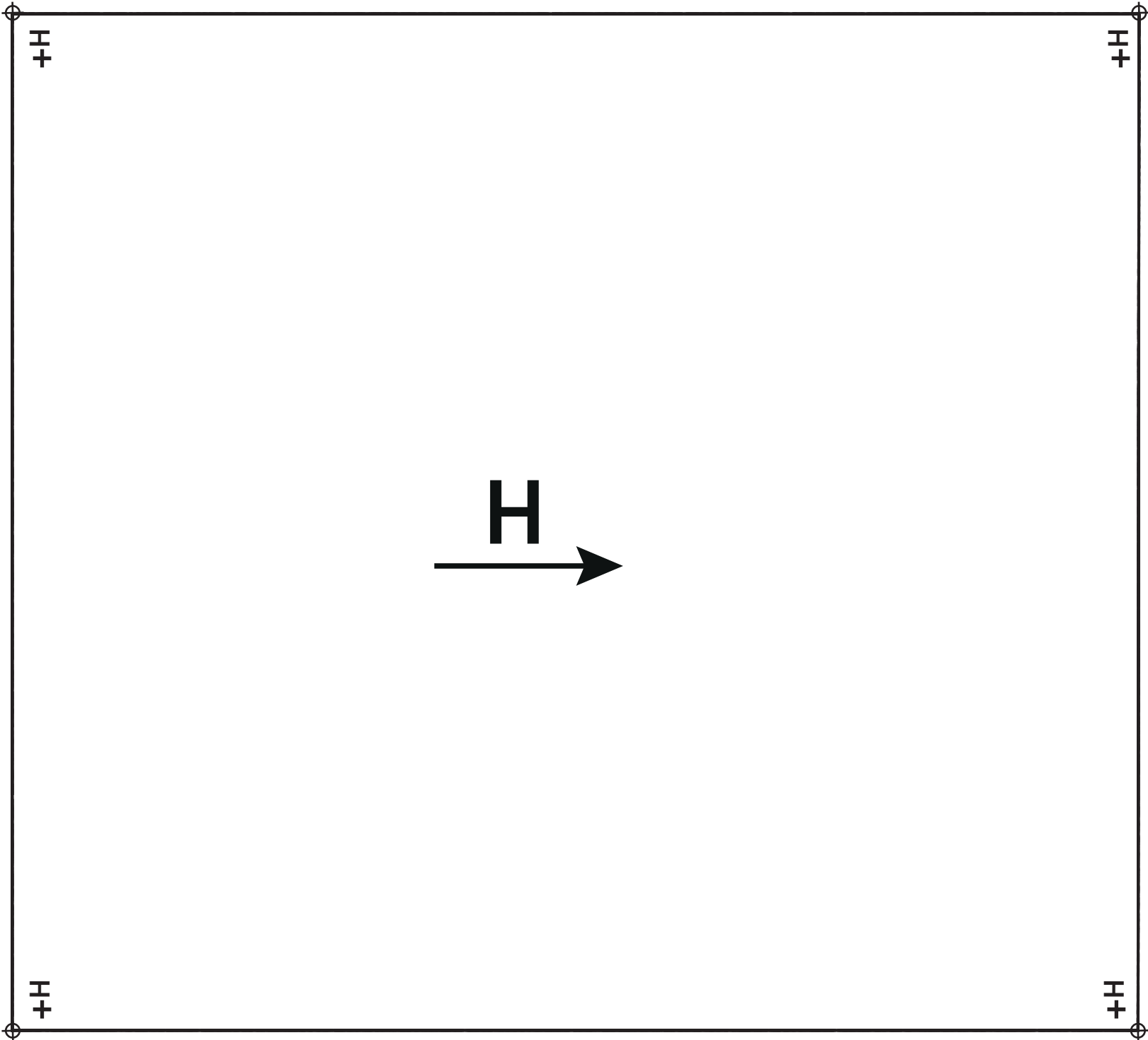

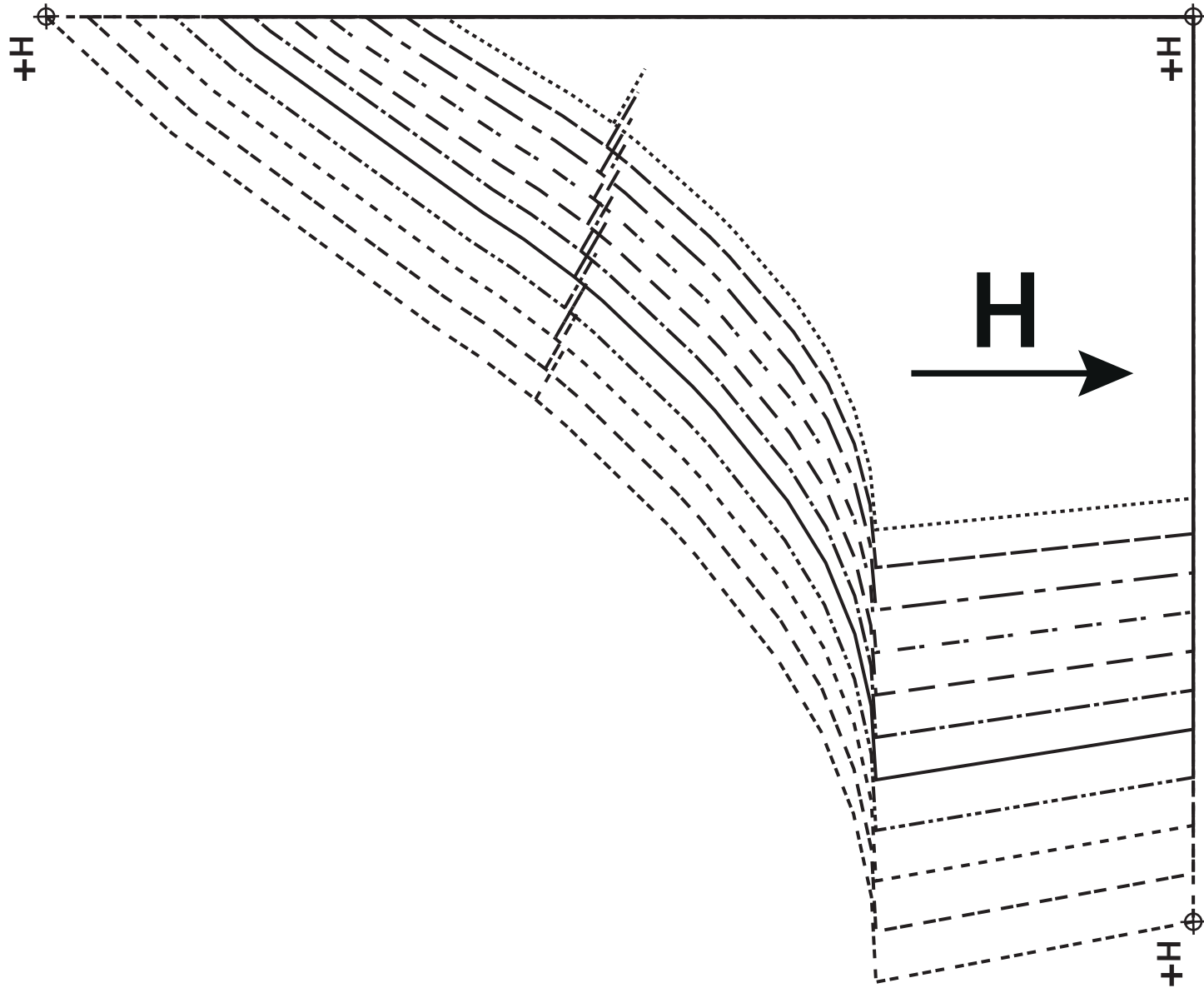

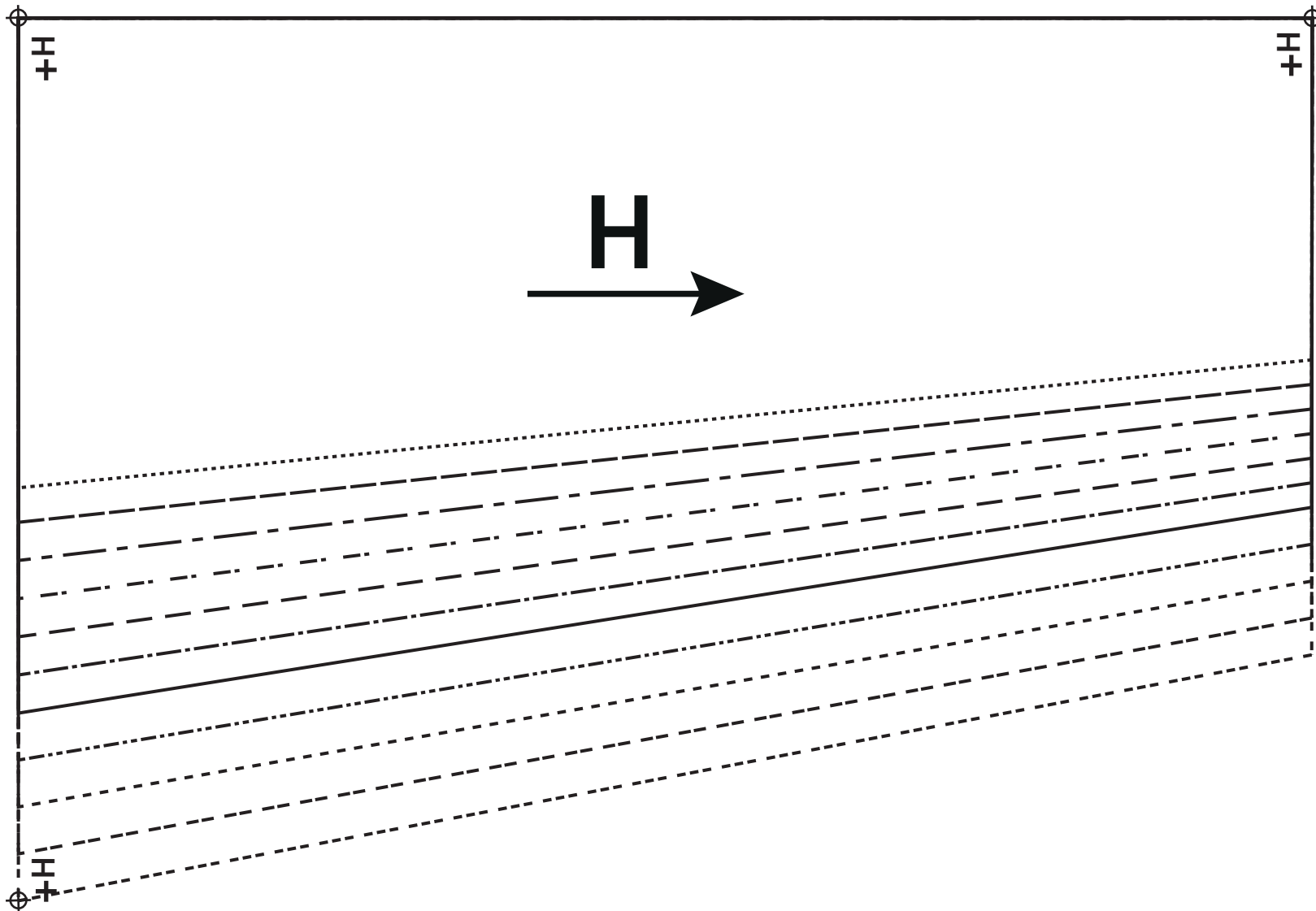

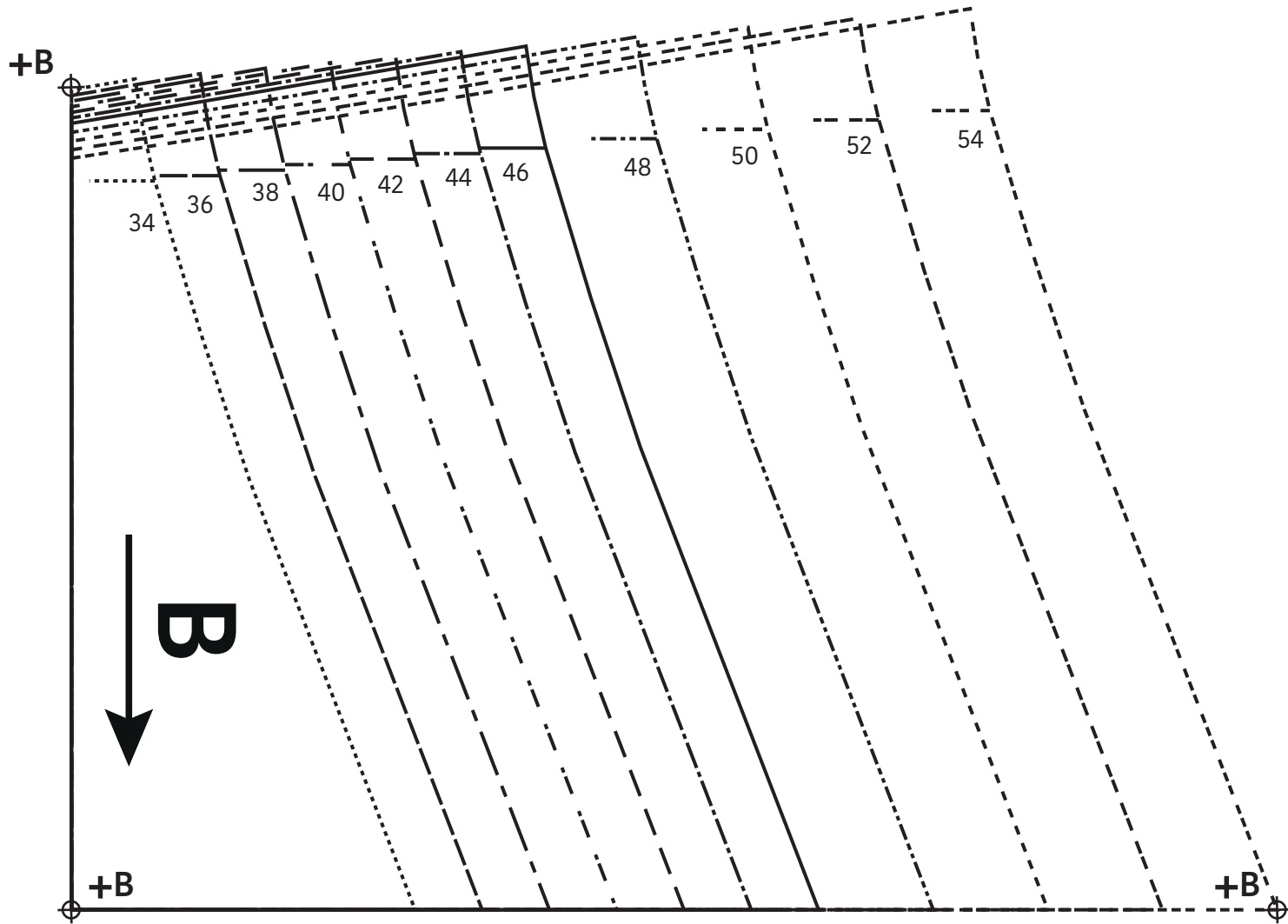

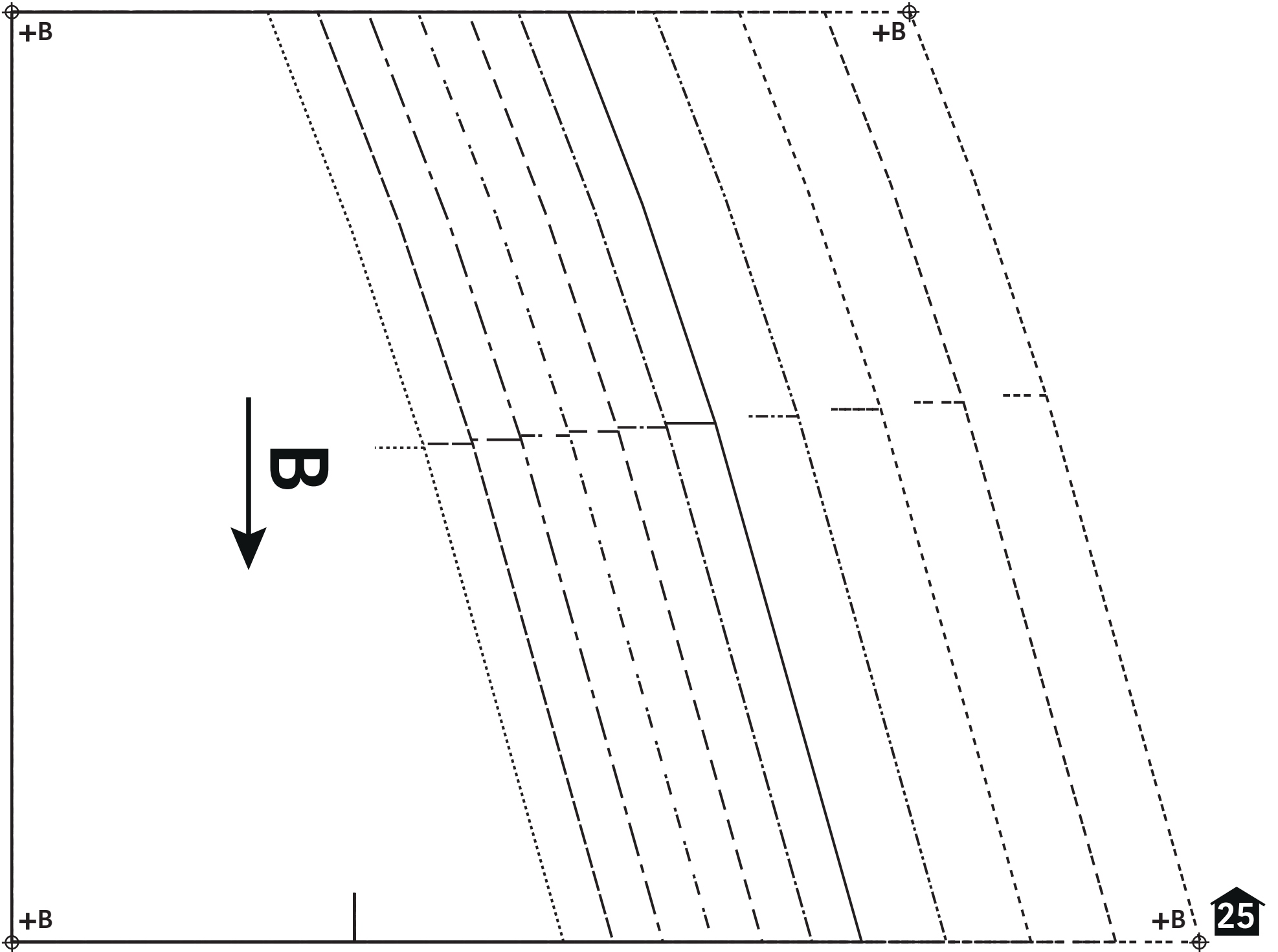

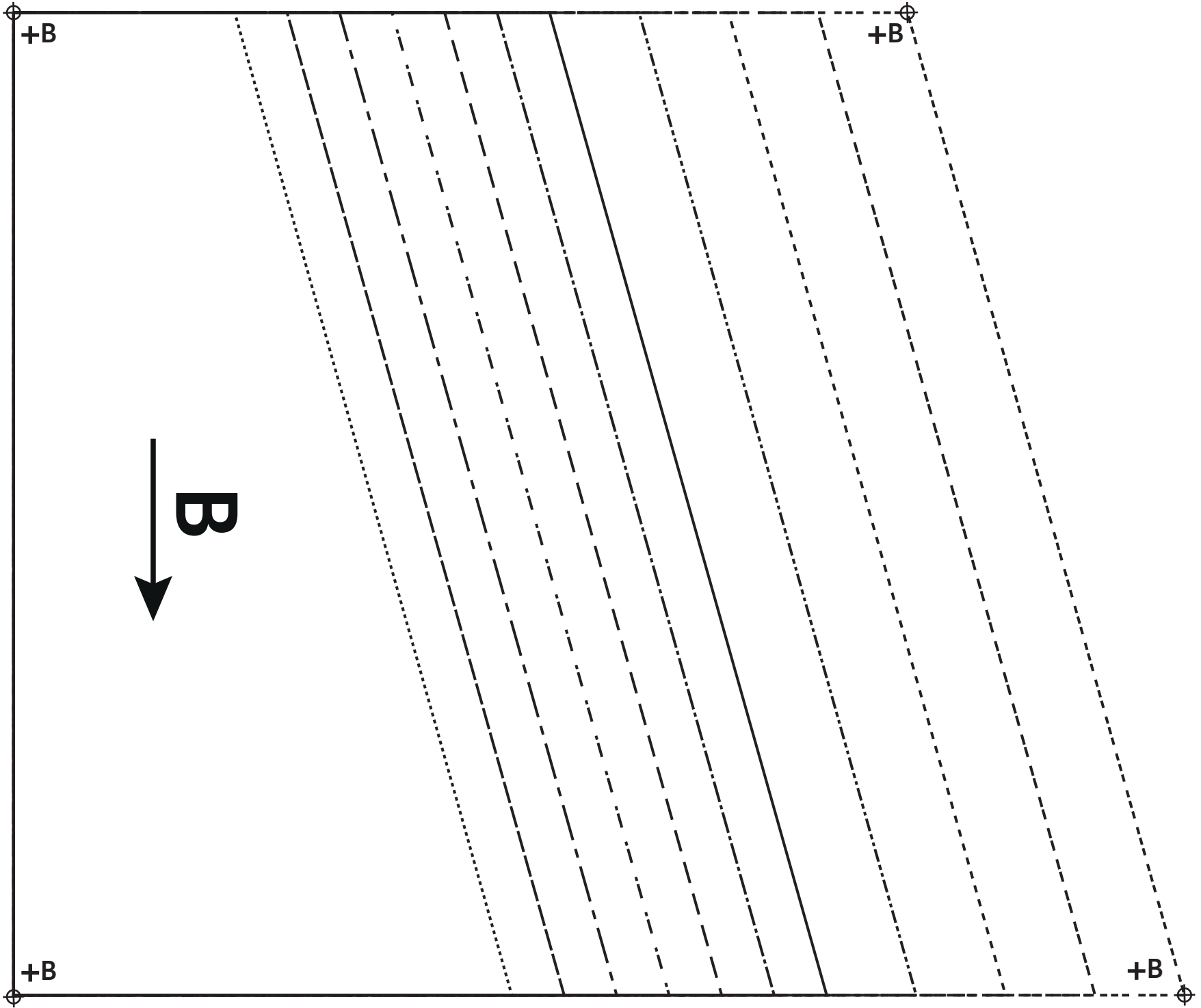

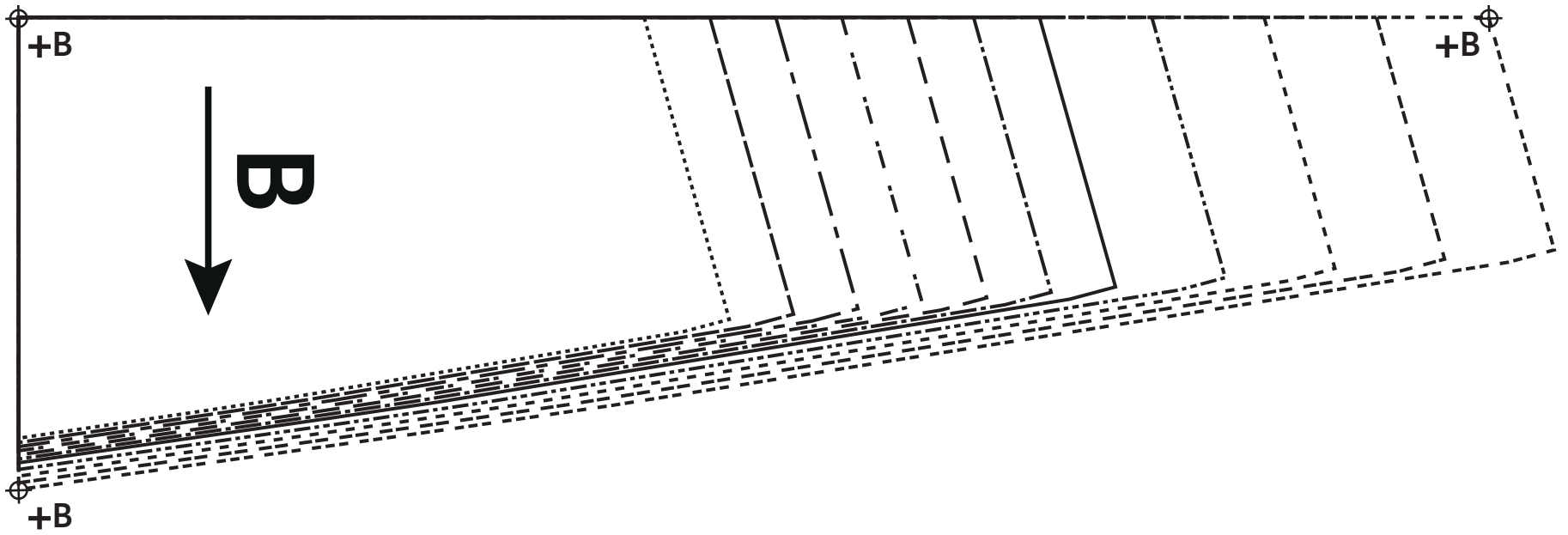

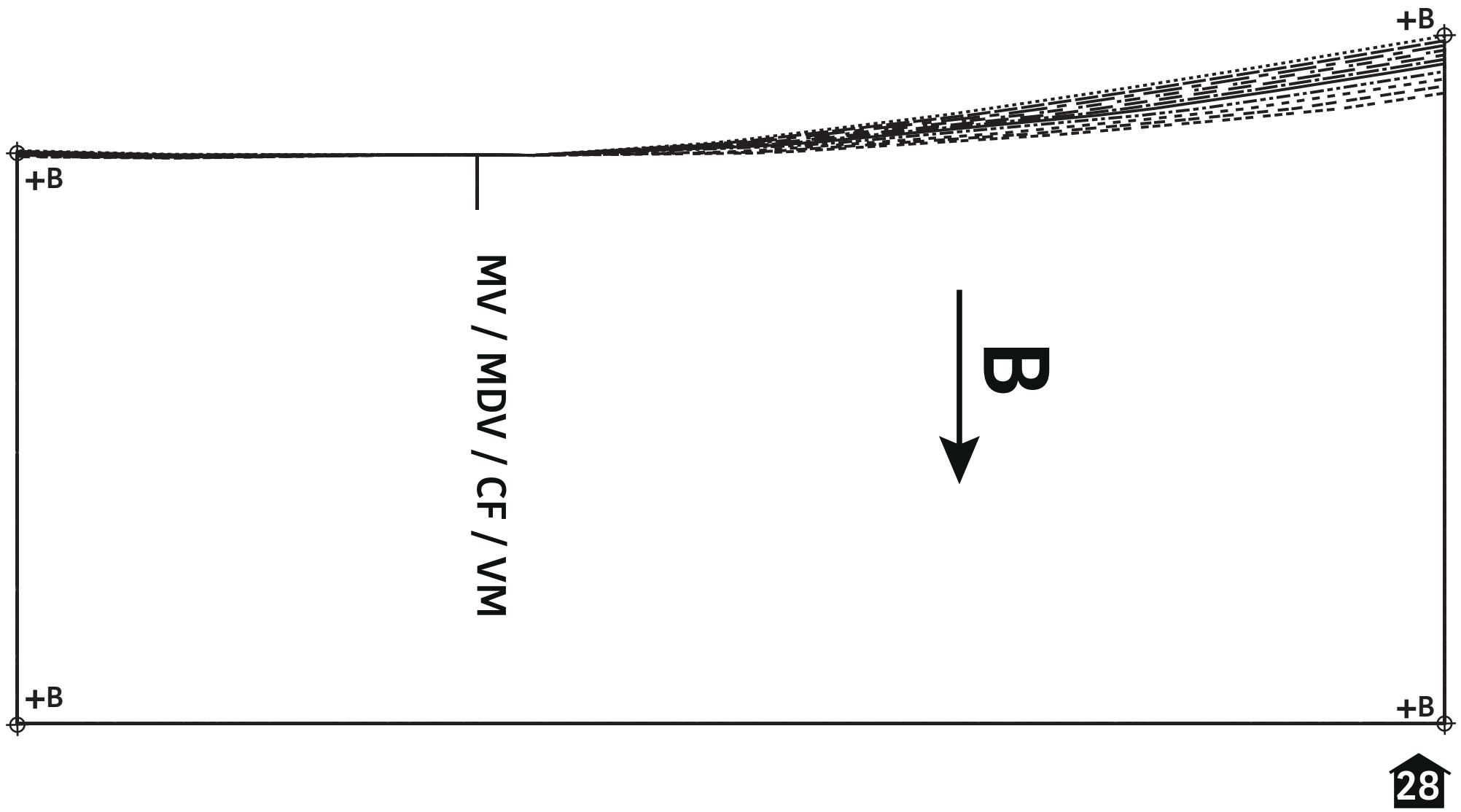

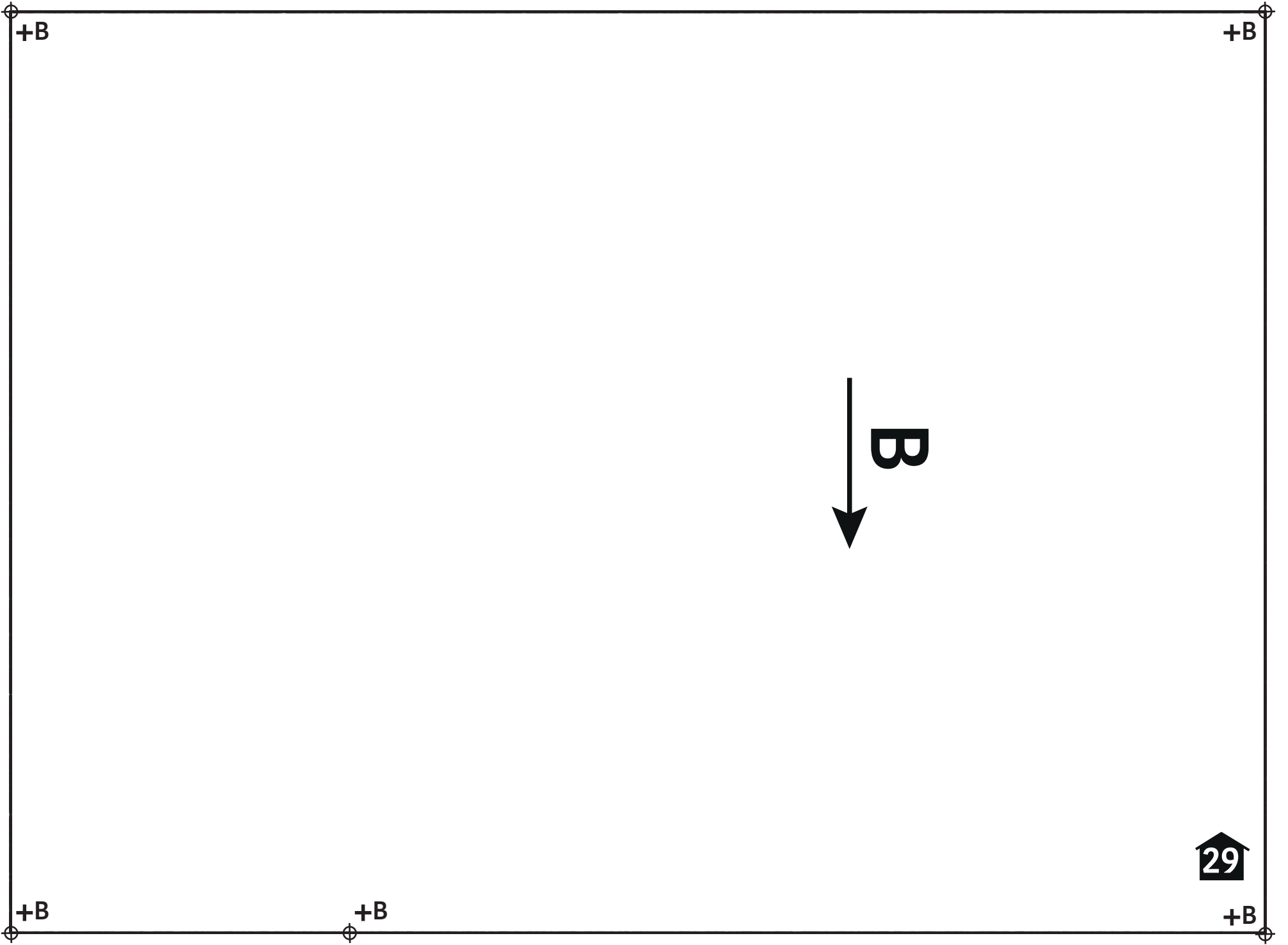

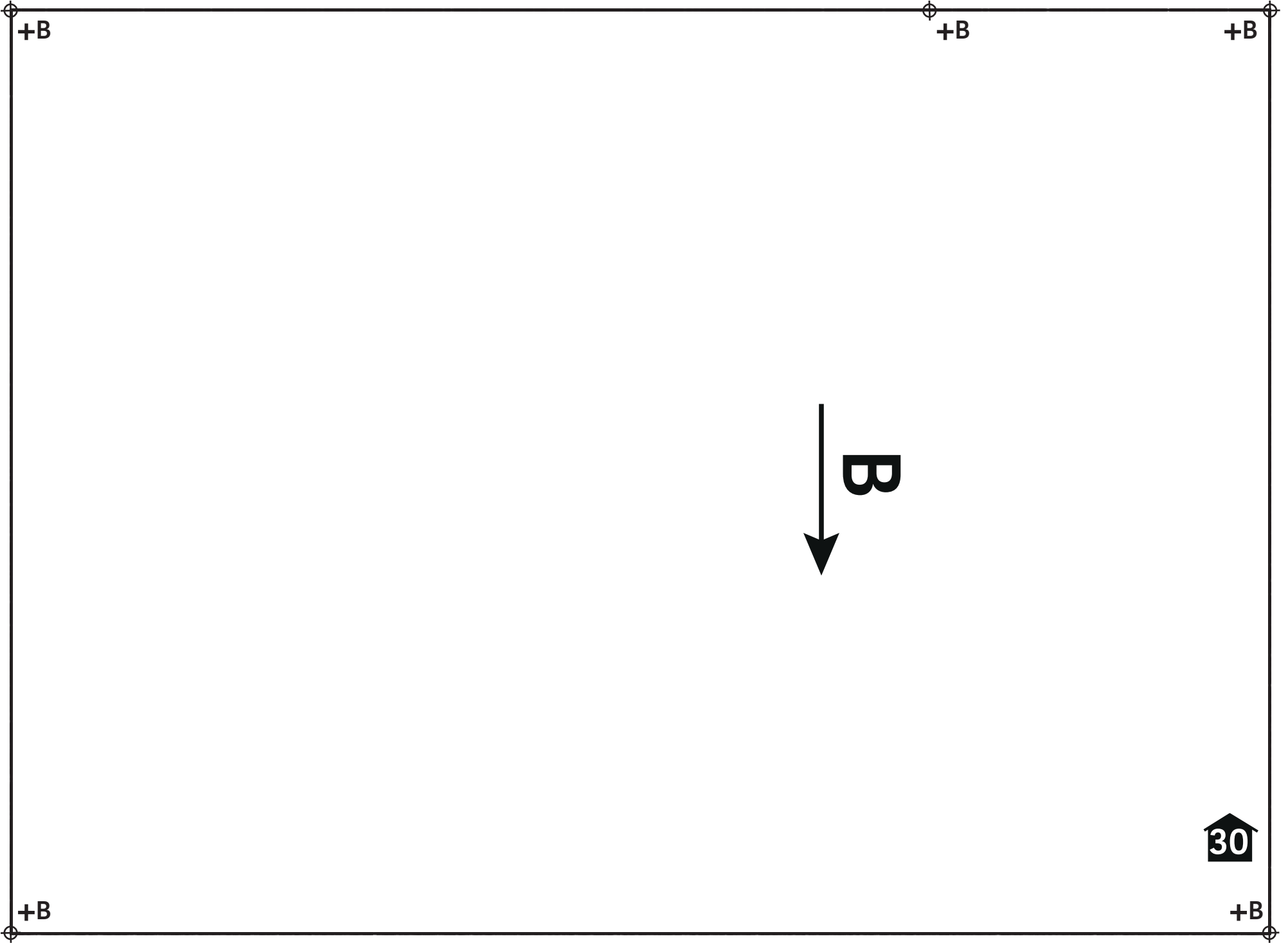

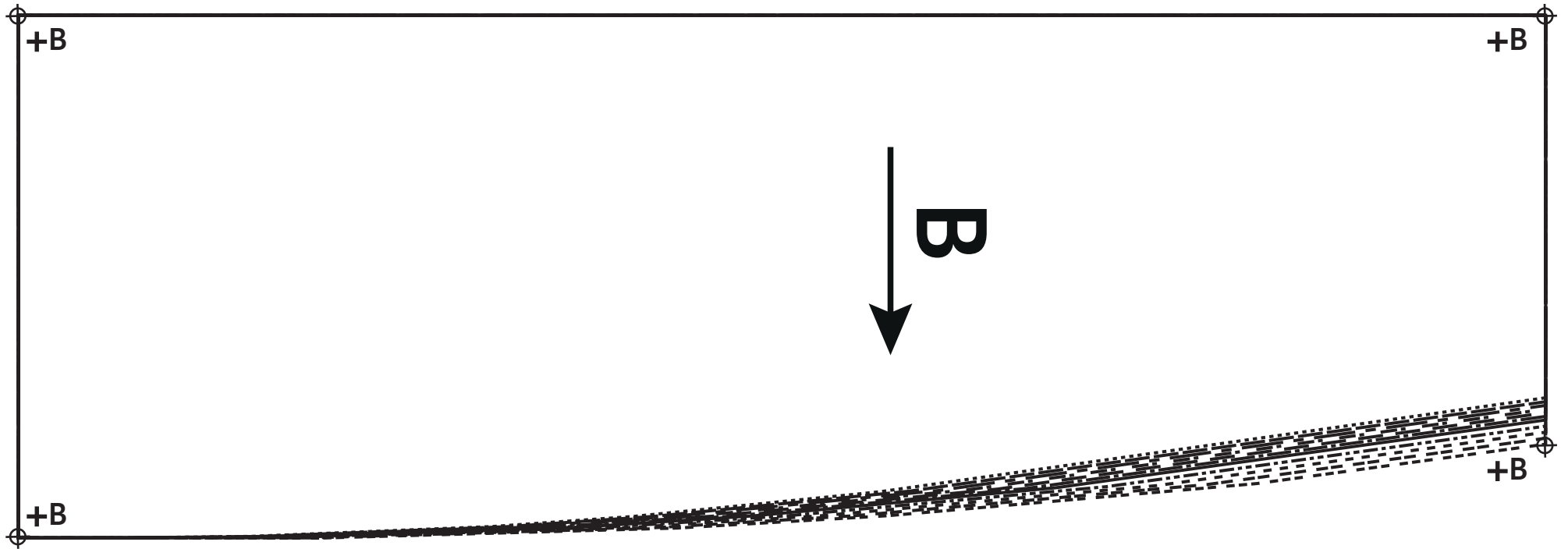

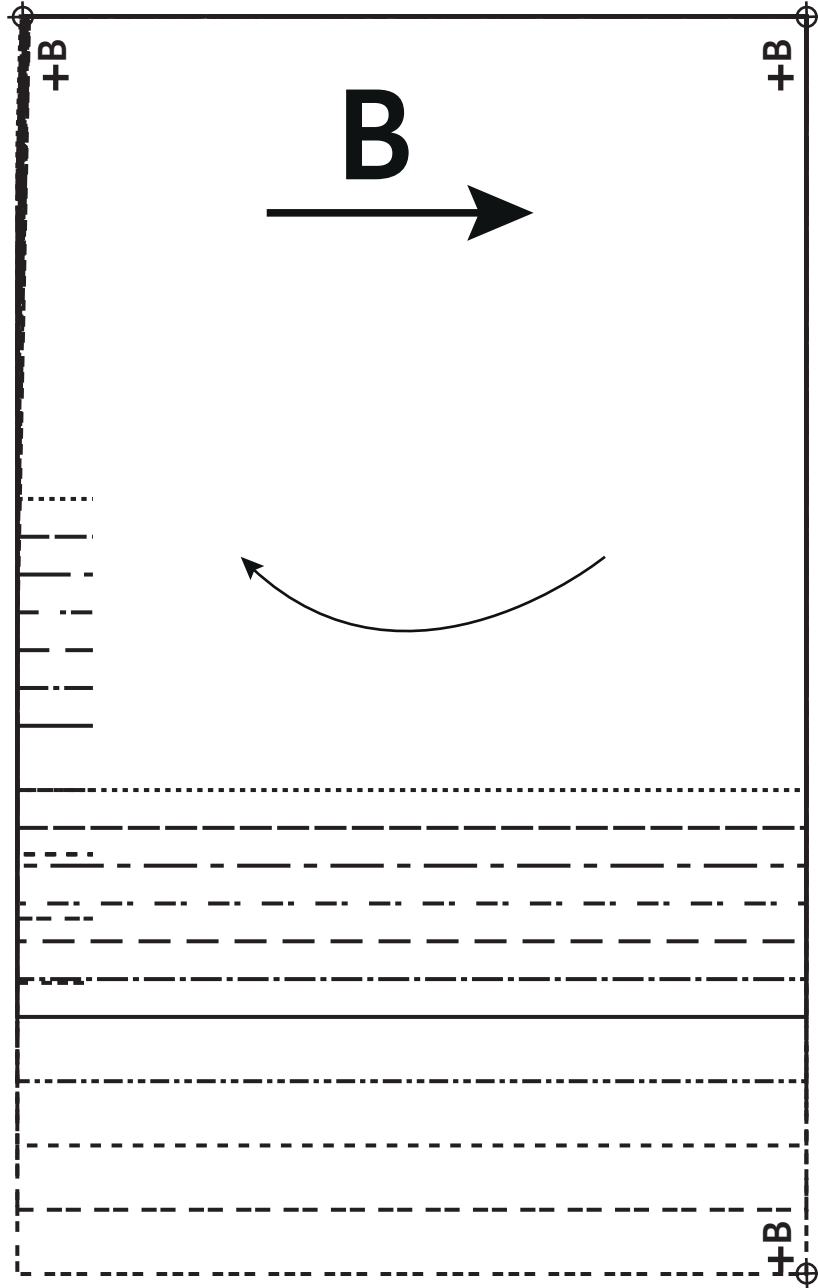

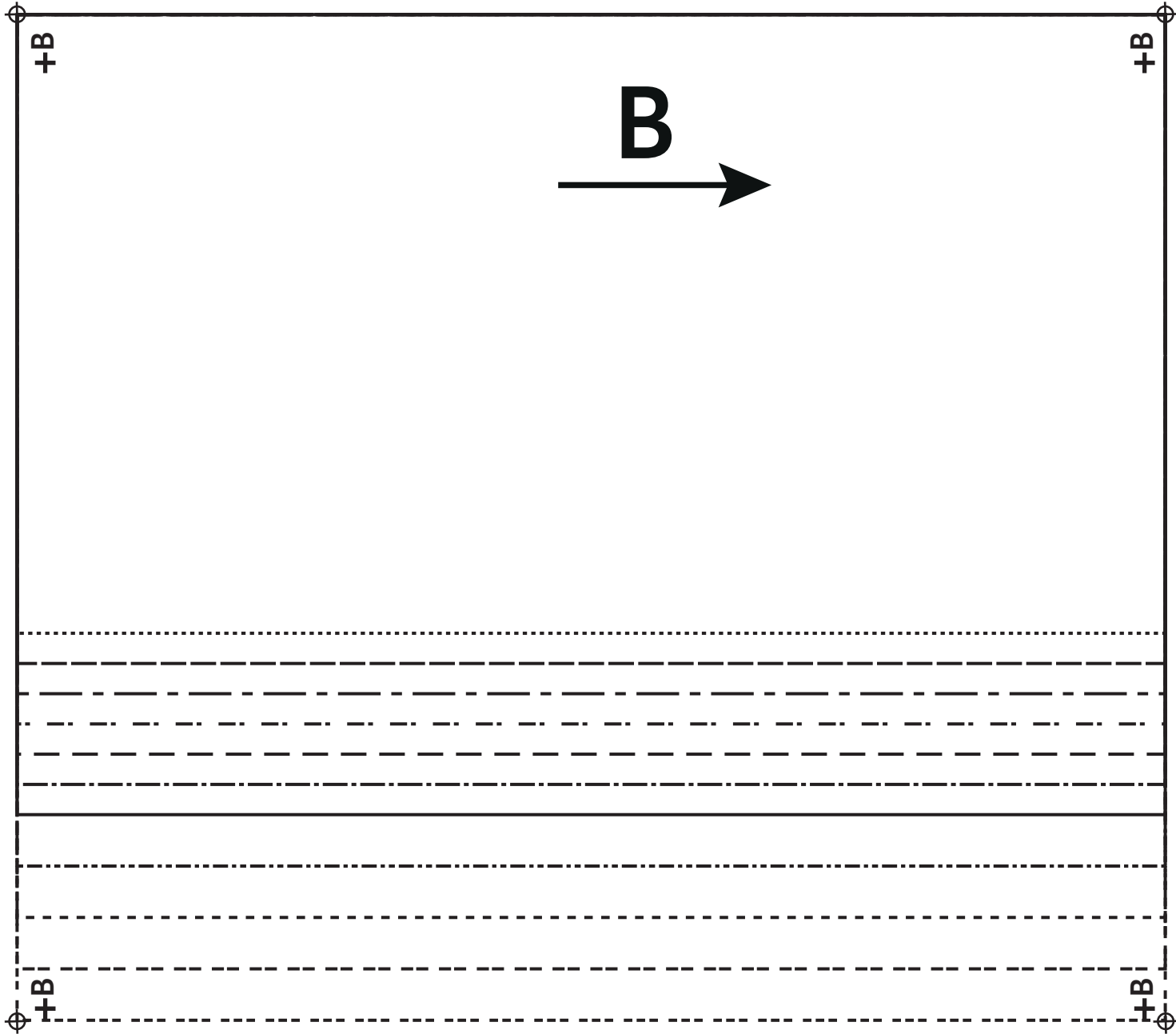

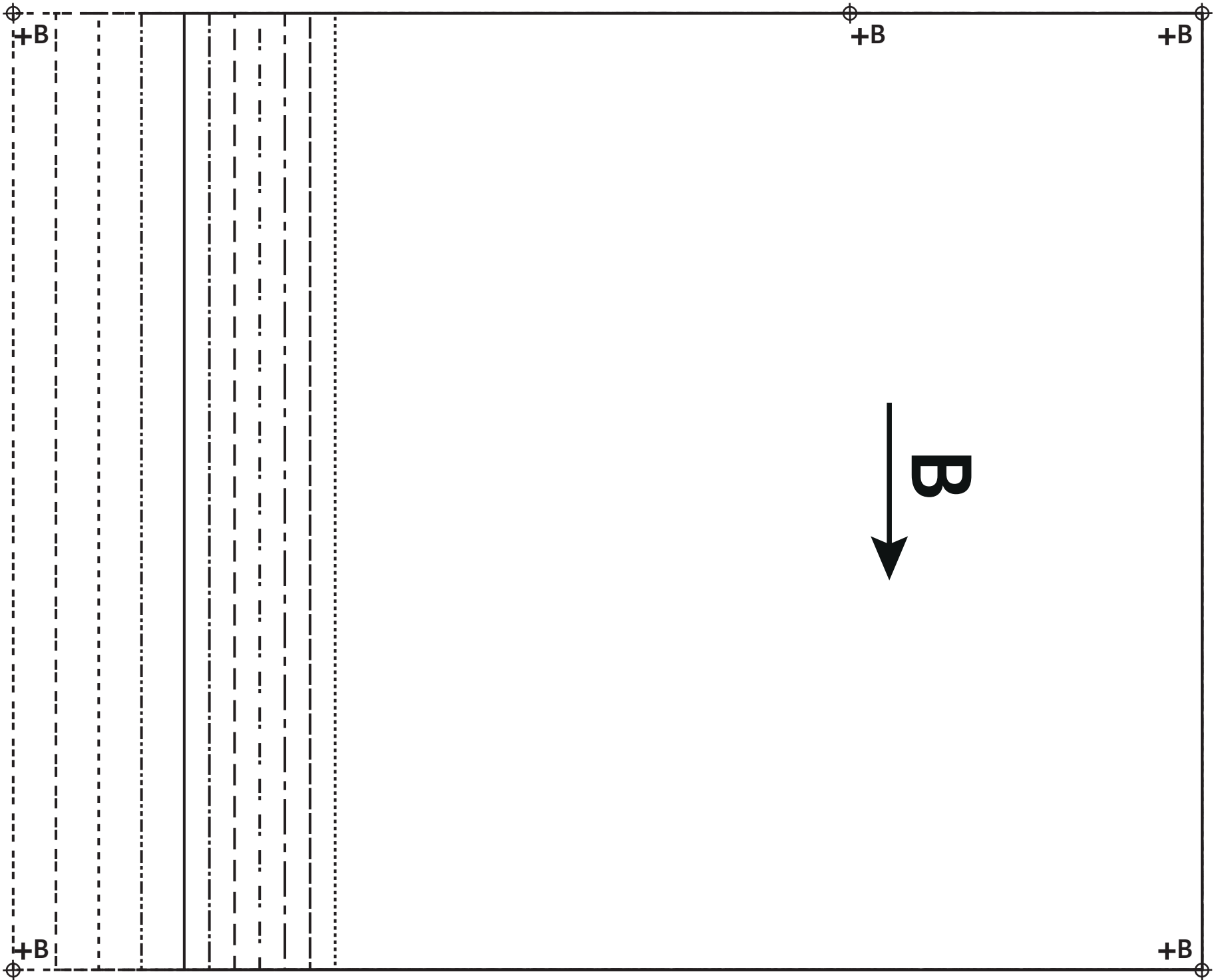

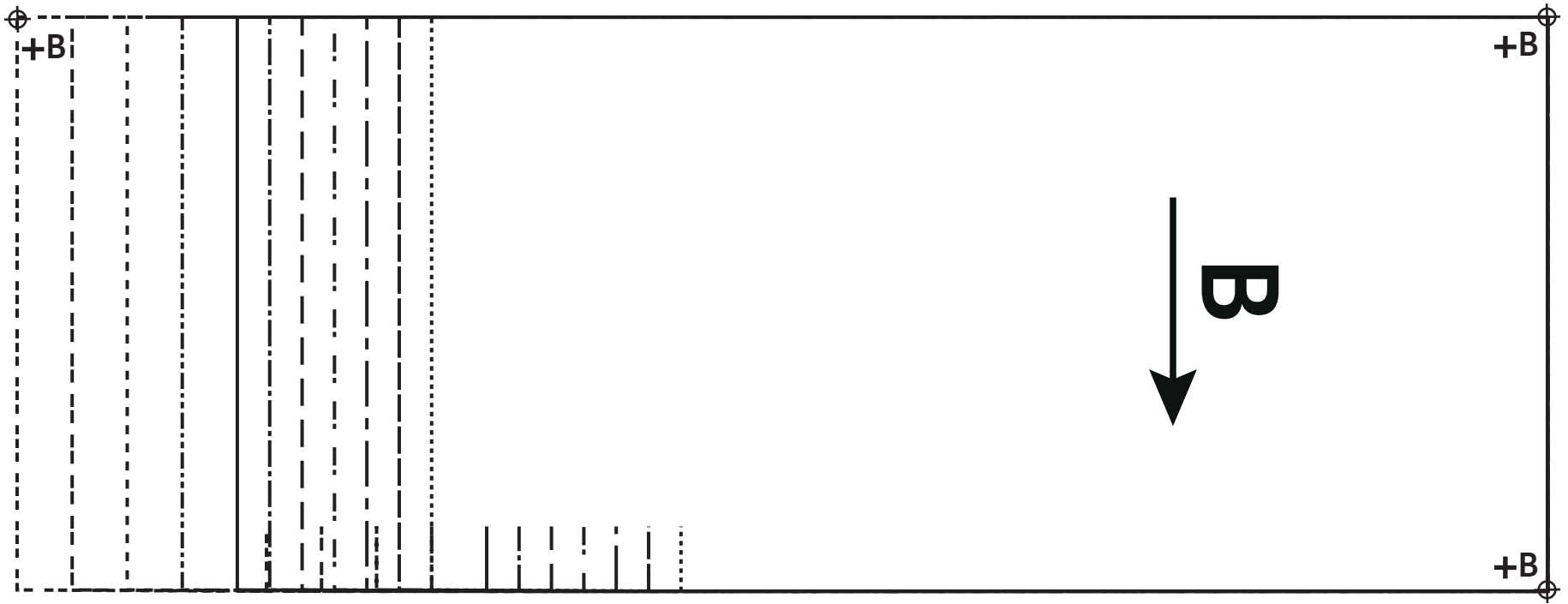

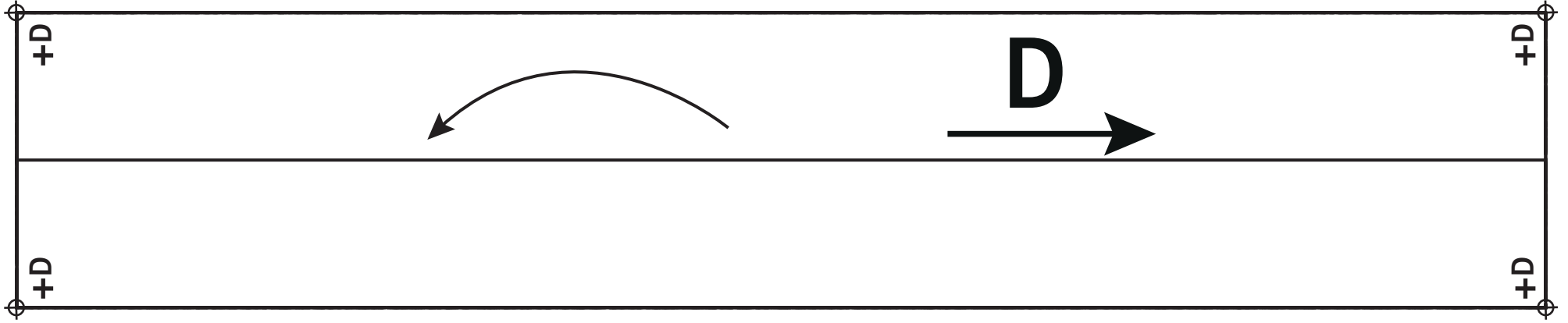
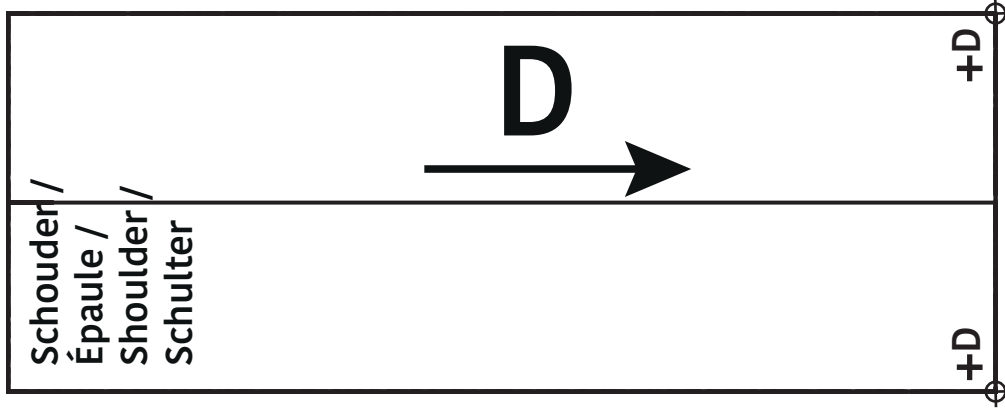

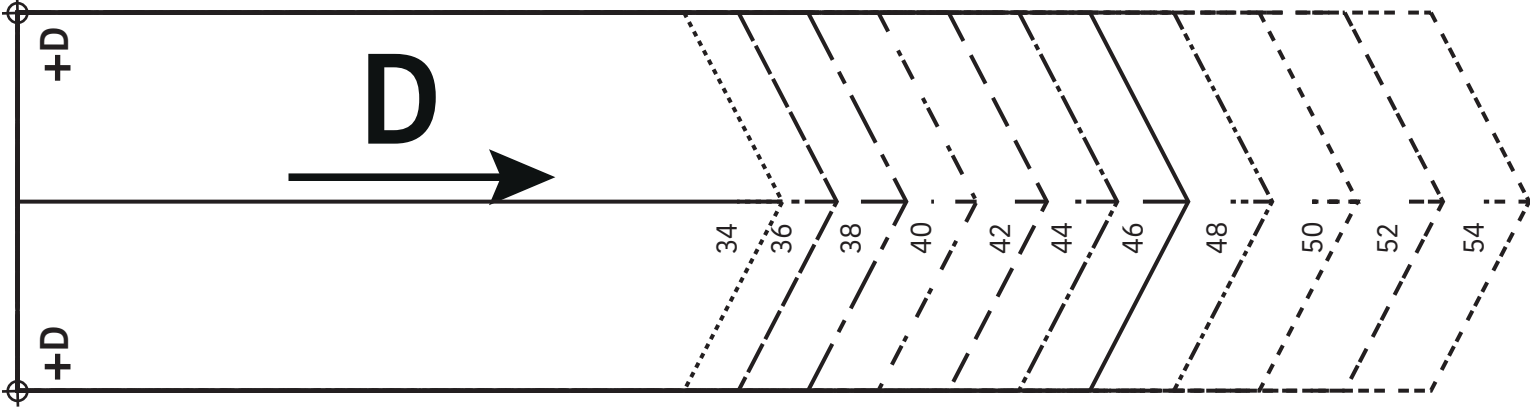

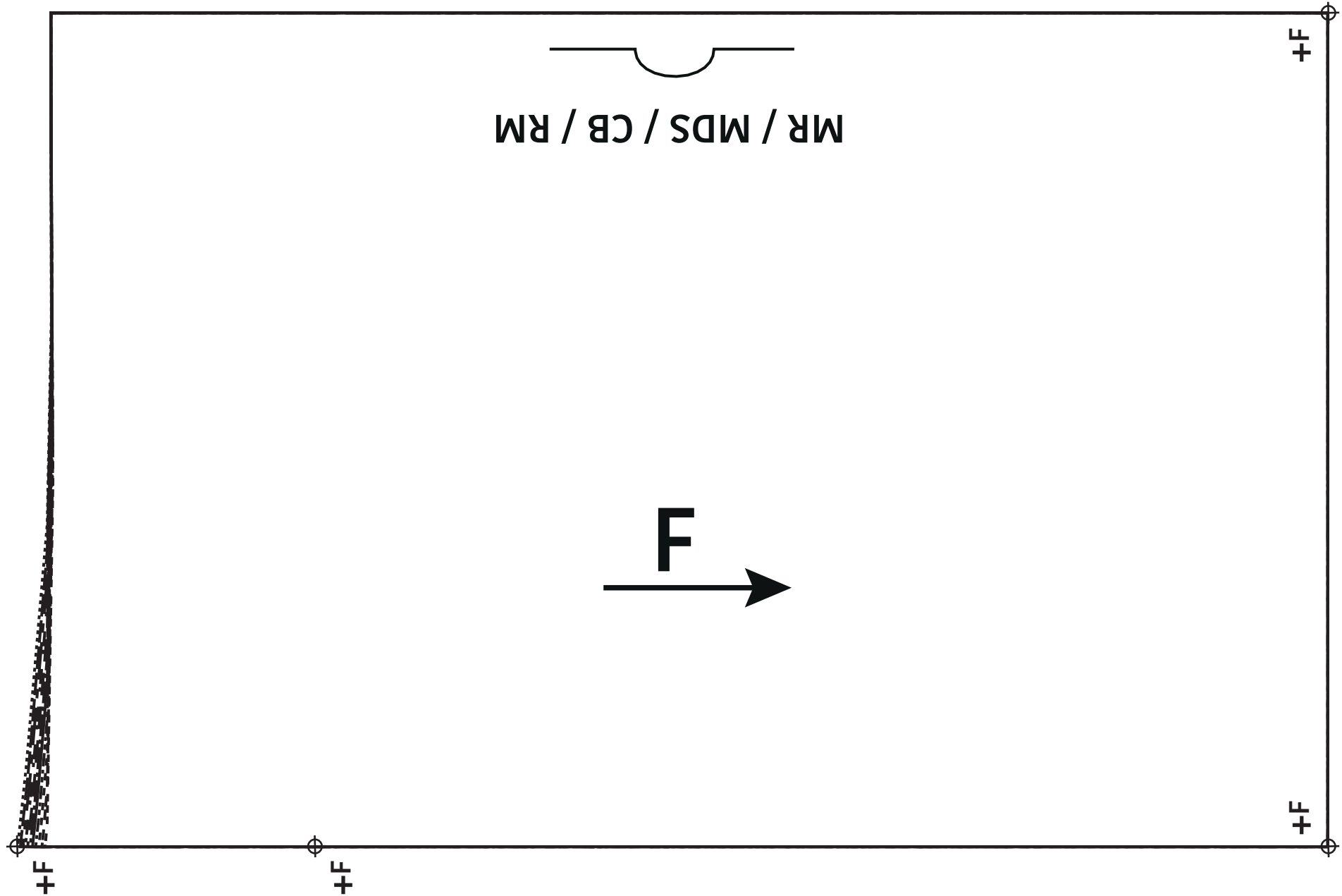

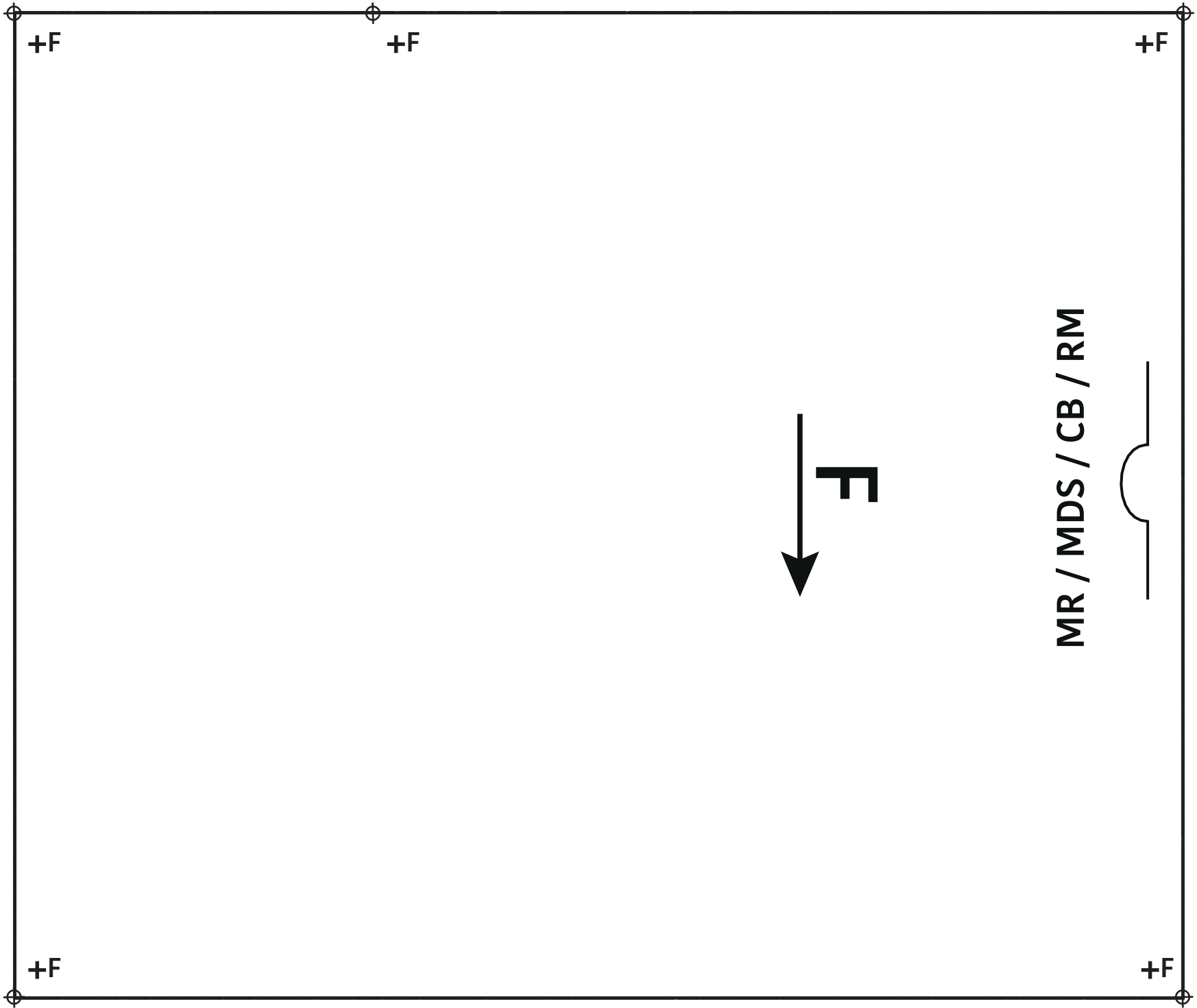

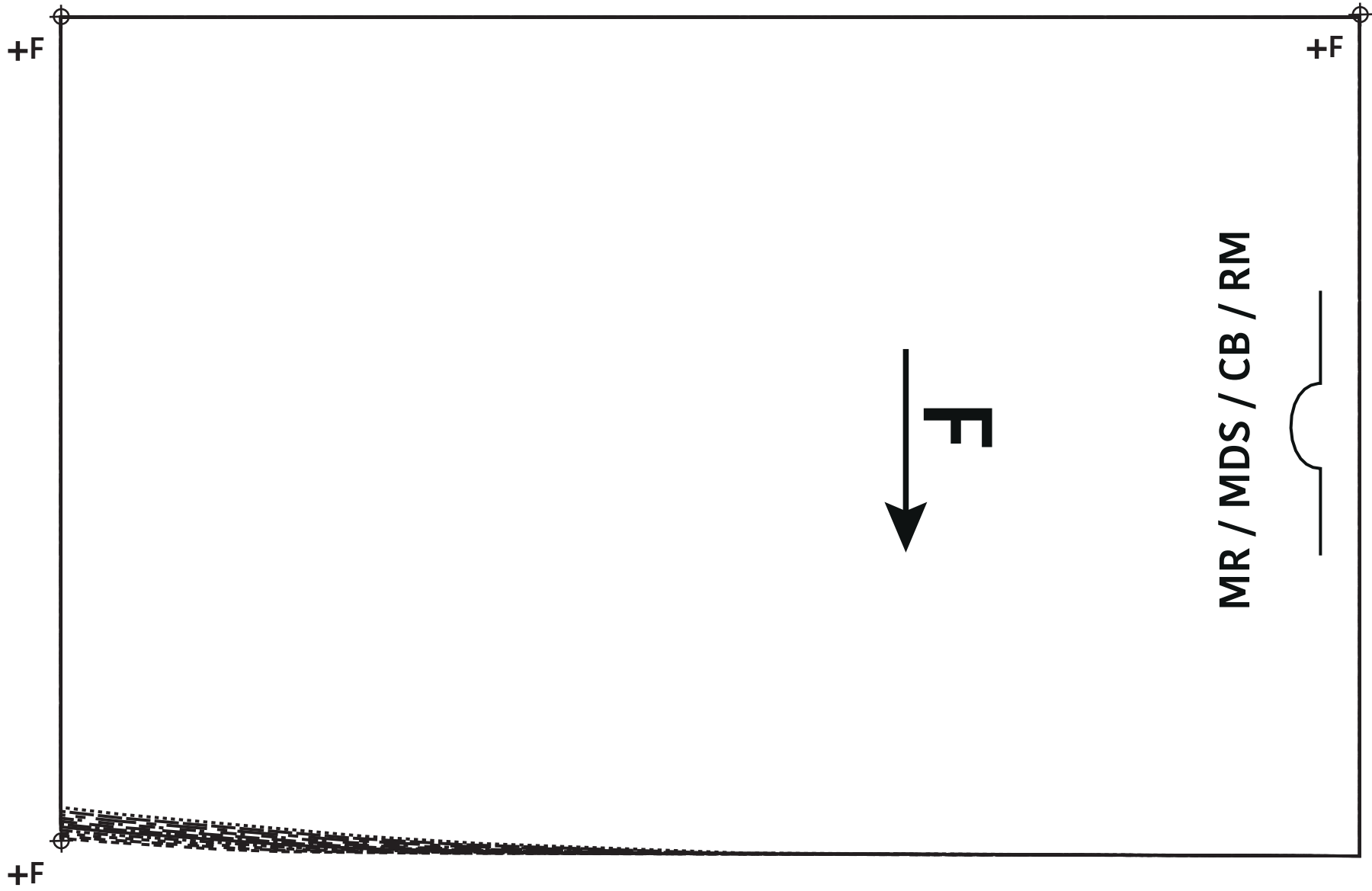

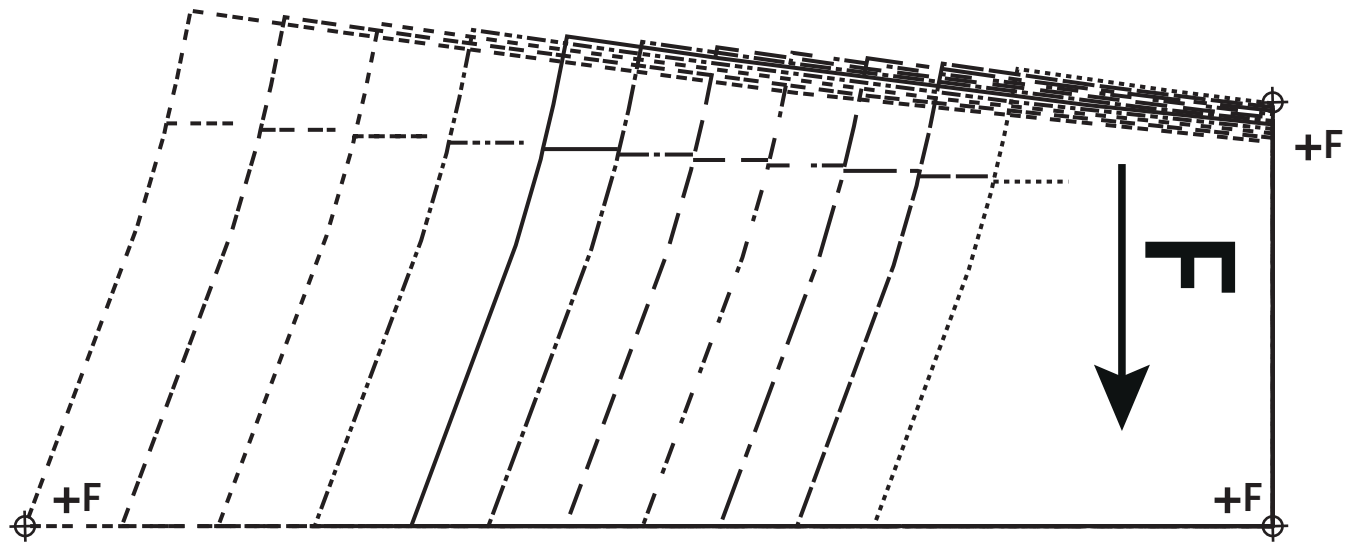

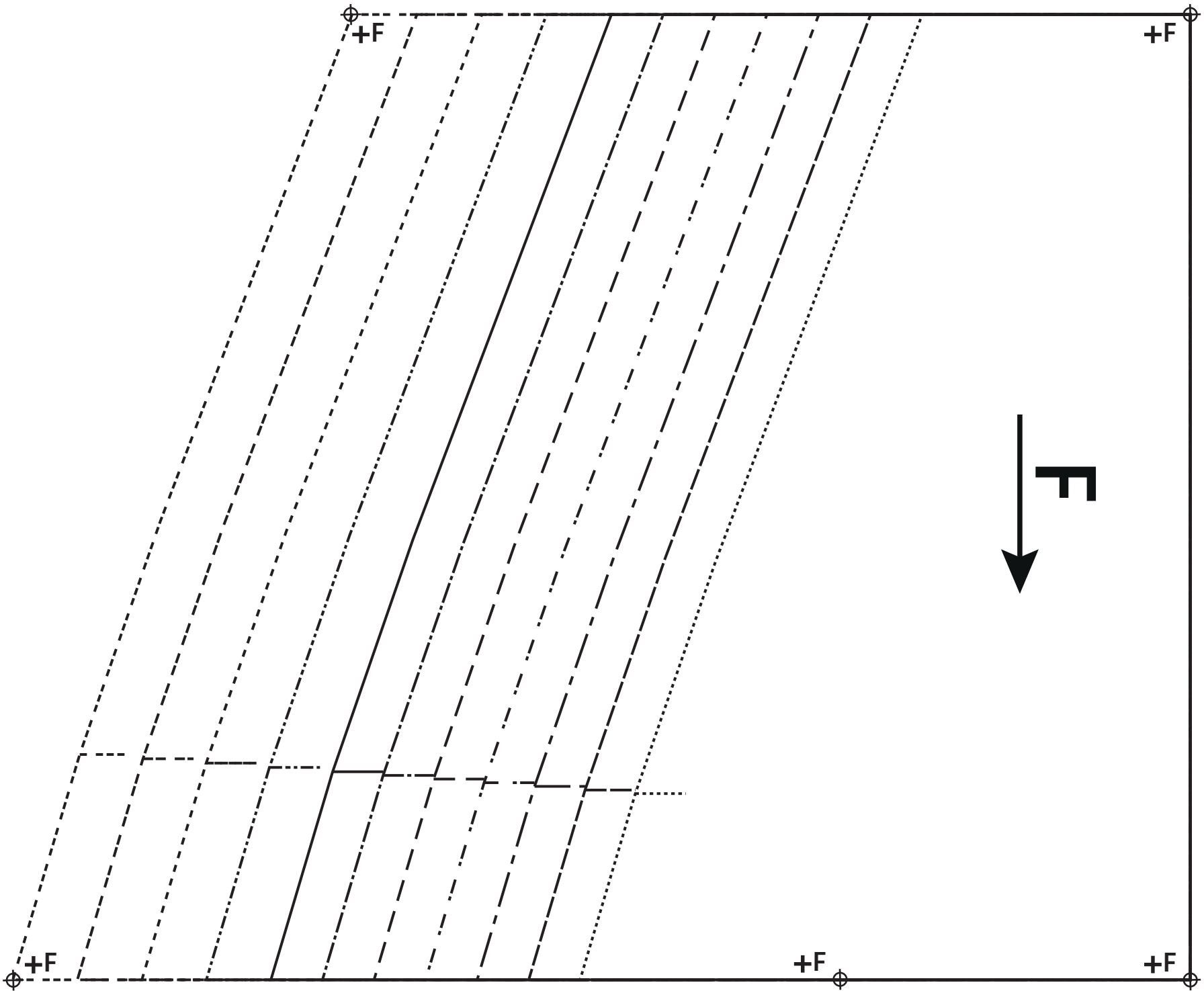

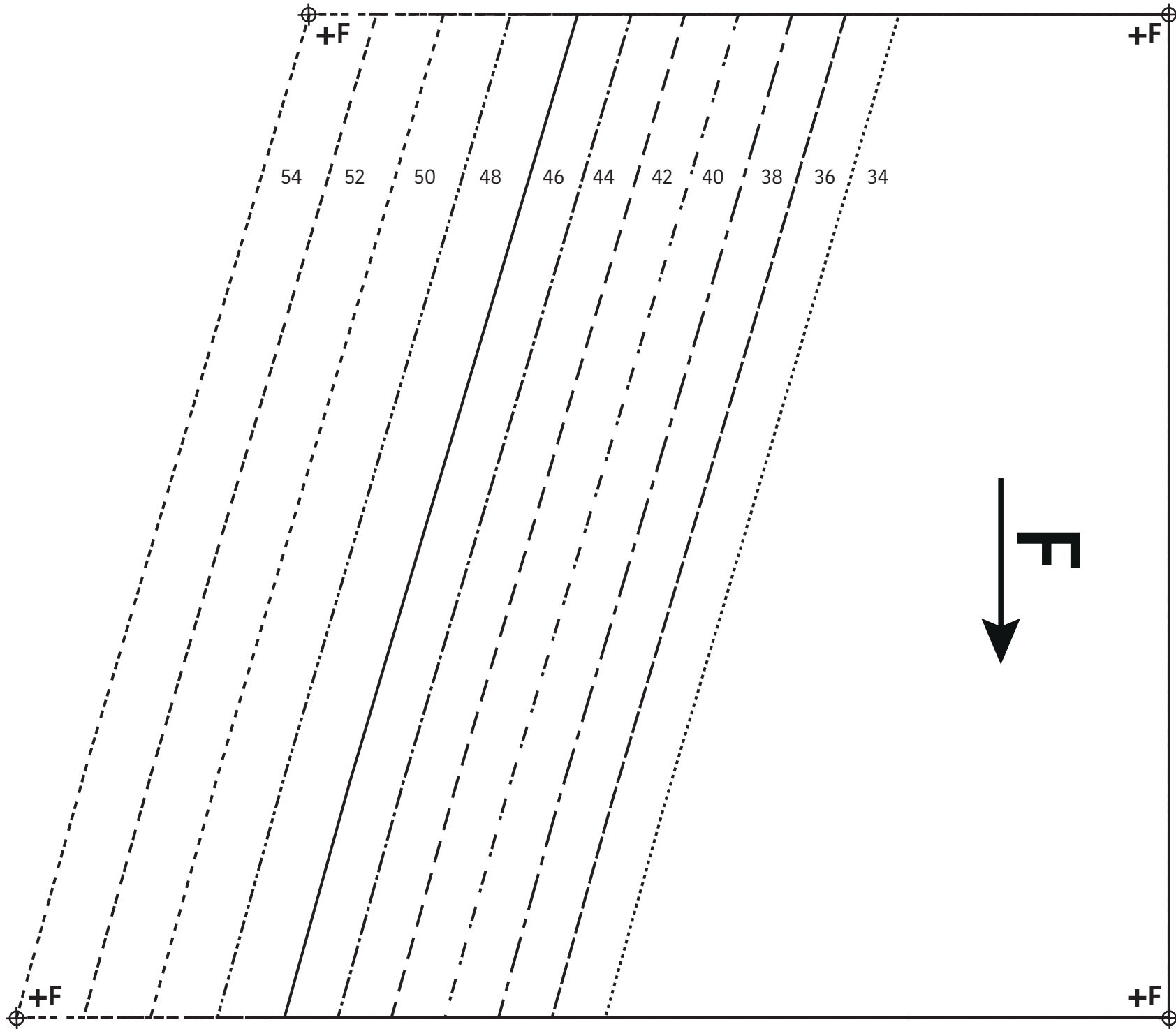

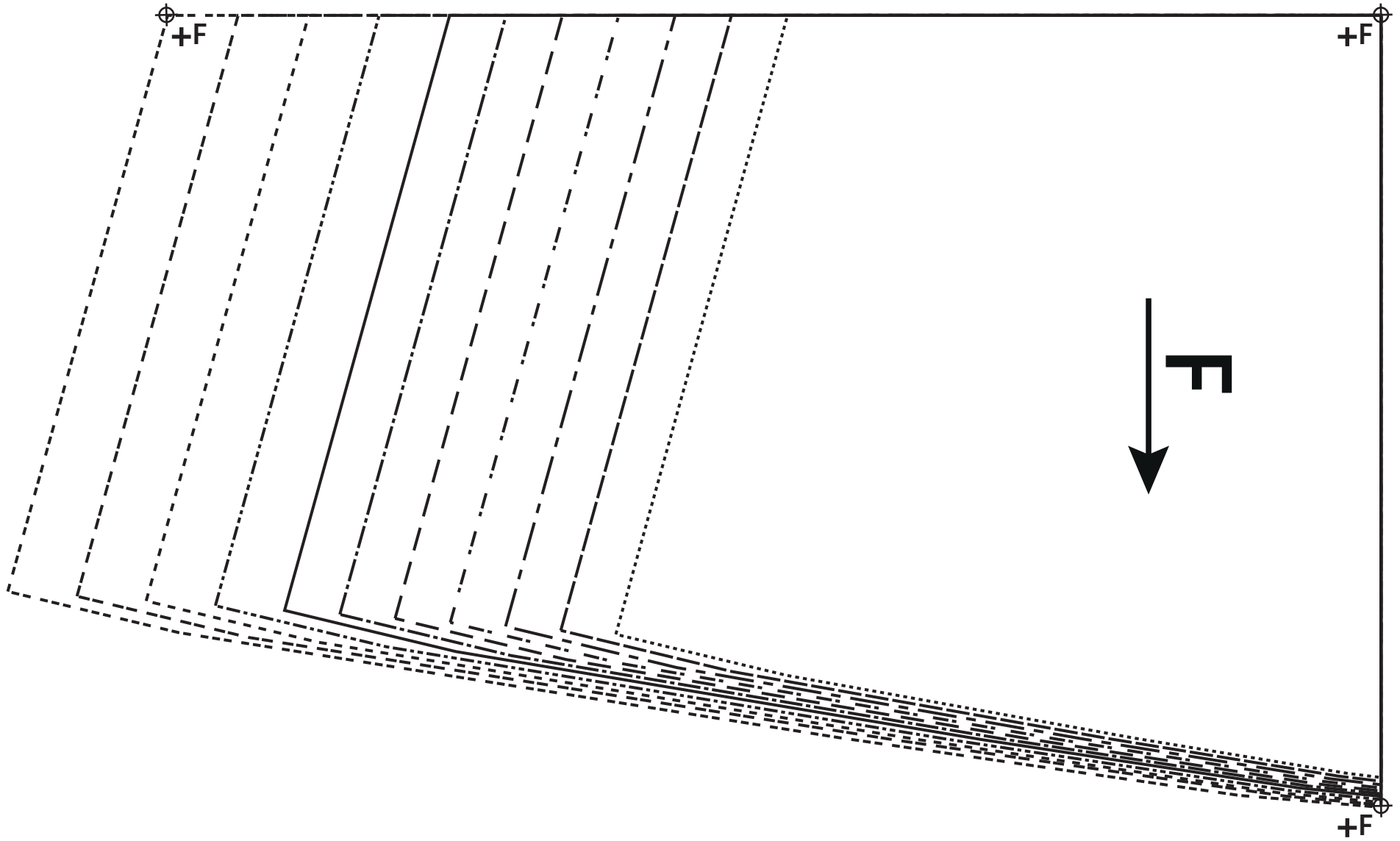

54
52
50
48
46
44
42
40
38
36
34
32

↑
↓

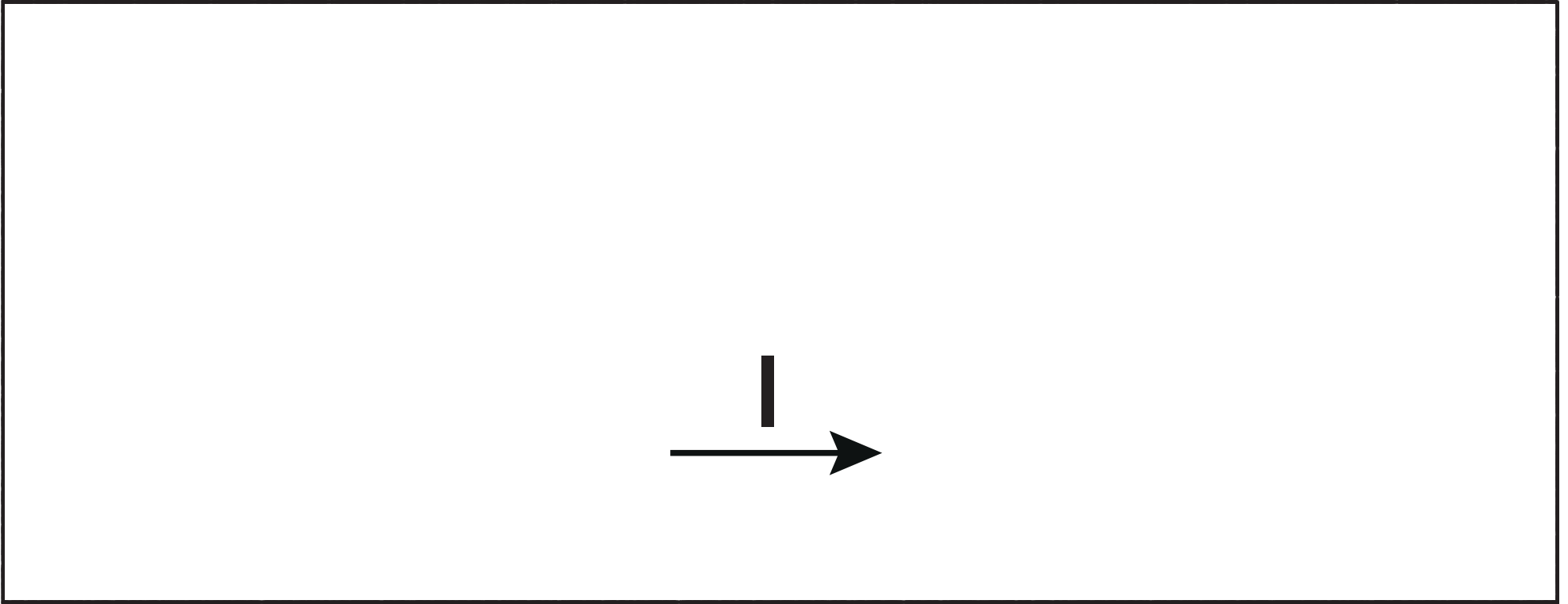

l+

l+



Rechts / Droit /
Right / Rechts

