

Elin

**Kamerjas / Peignoir /
Dressing gown /
Morgenmantel**

**Patroondelen / Pièces du patron /
Pattern pieces / Schnittteile:**

- A** voorpand / devant / front panel /
Vorderteil
- B** rugpand / dos / back panel /
Rückenteil
- C** halsboord / liseré d'encolure /
collar / Halsbündchen
- D** taillelint / ceinture / belt /
Taillenband
- E** pat lintopening / passageceinture /
placket for ribbon opening /
Leiste an der Öffnung für das Band

Patroonschema / Schéma du Patron / Pattern Diagram /
Übersichtsplan zum Zusammenkleben

1	2	3	4	5	6
7	8	9	10	11	12
13	14	15	16	17	18
19	20	21	22	23	24
25	26	27	28	29	30
31	32	33	34	35	36
37	38	39	40	41	42
43	44	45	46	47	48

Controlevierkant / Carré de controle
/ Test square / Kontrollquadrat

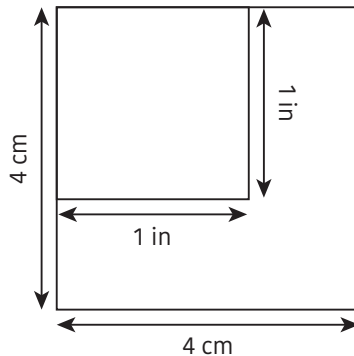

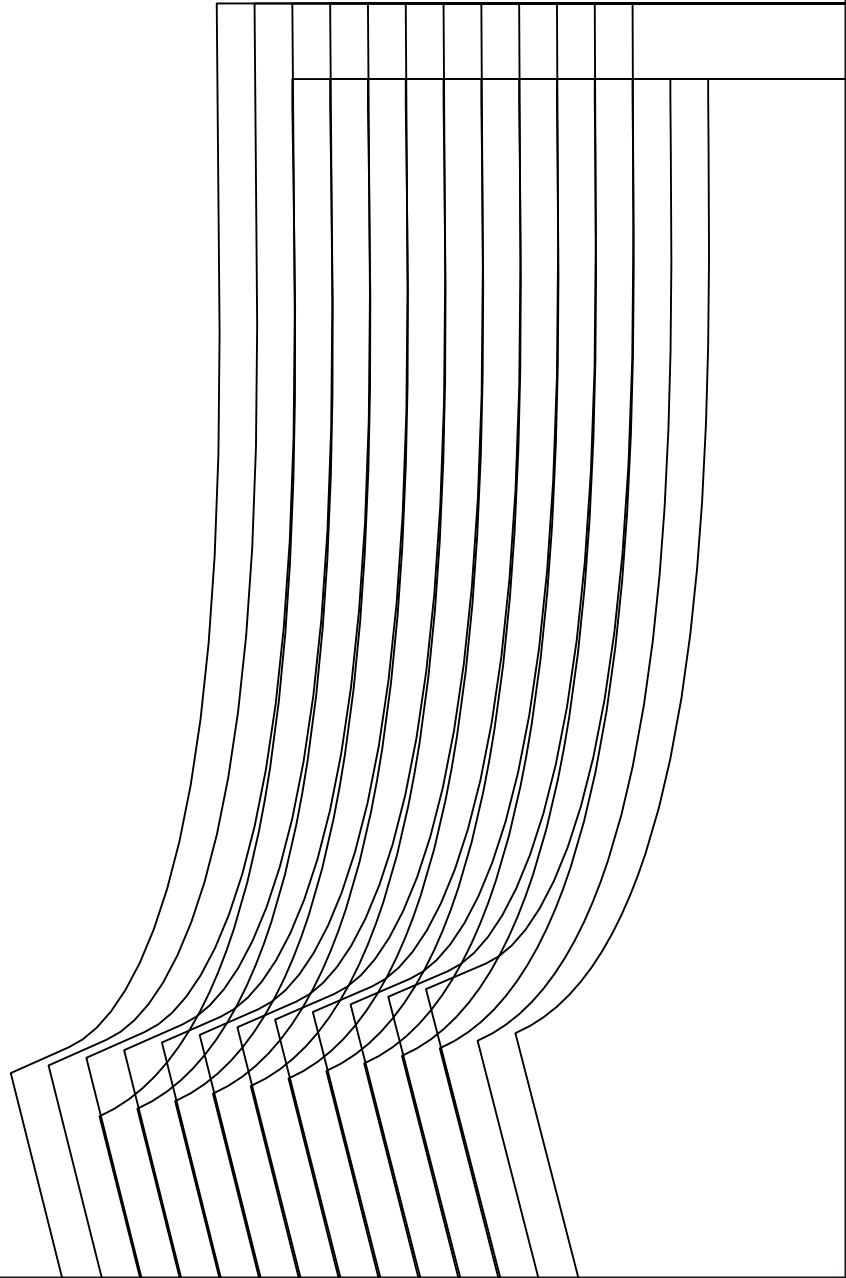
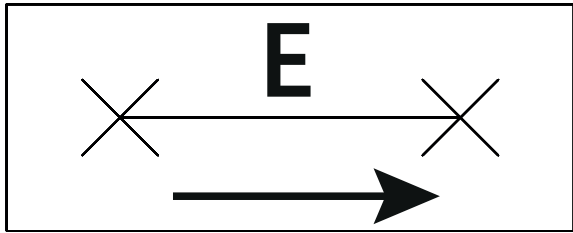



B

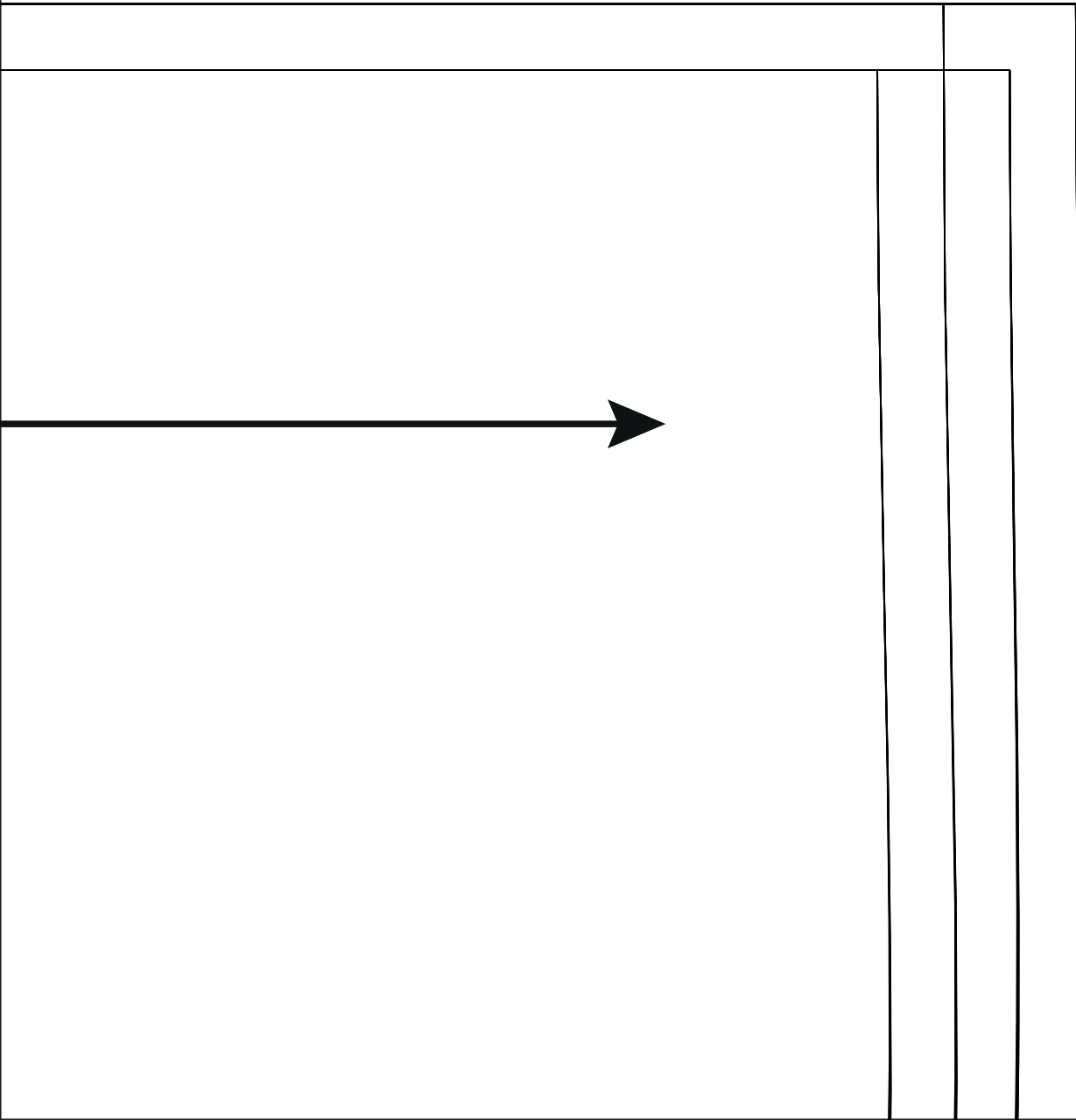

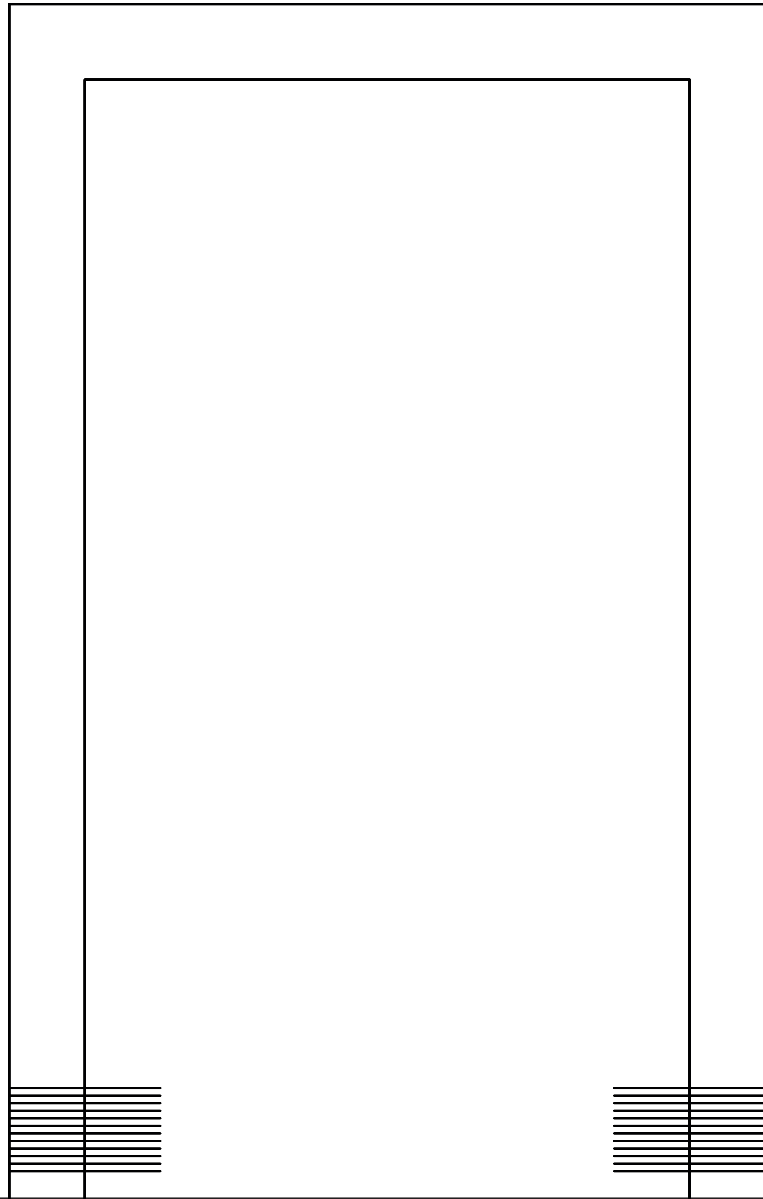

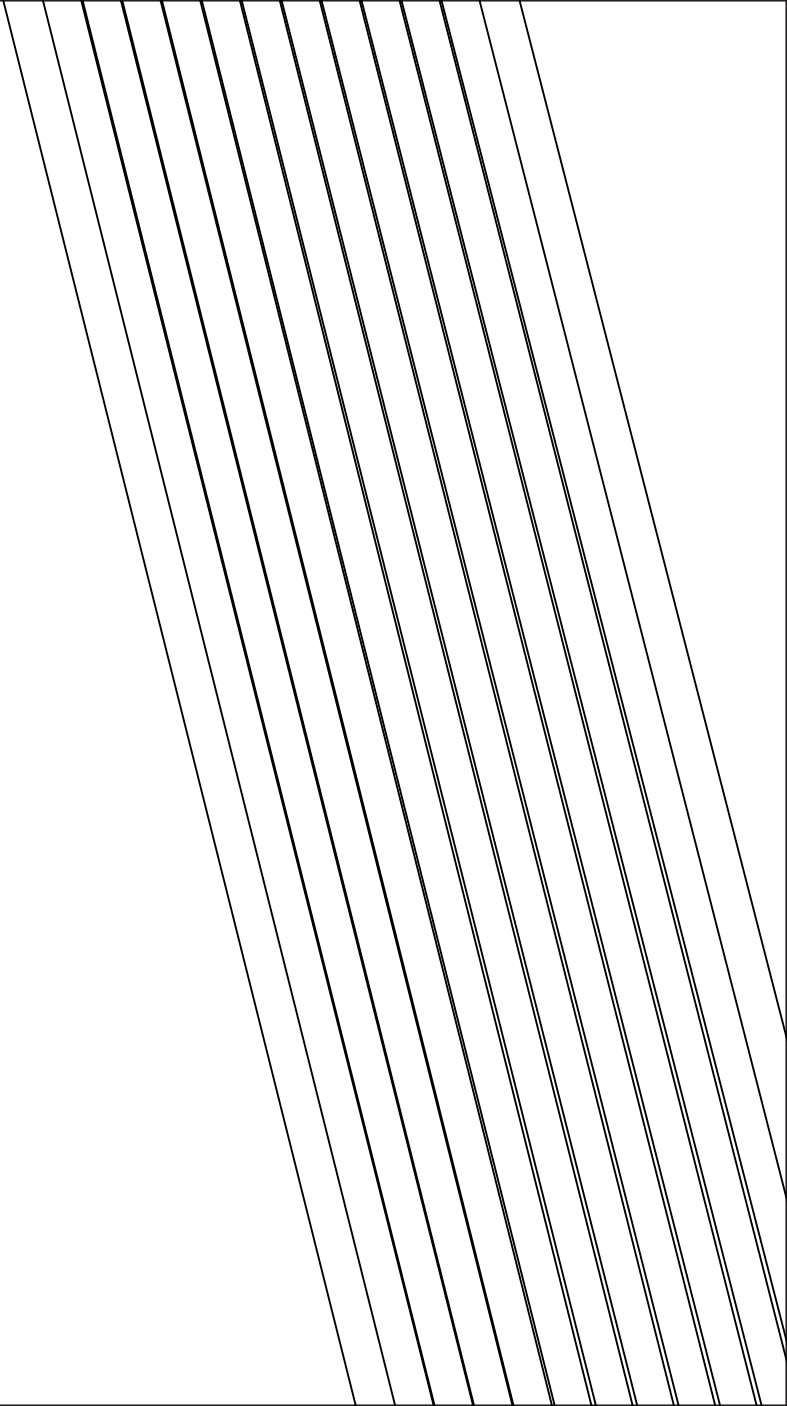
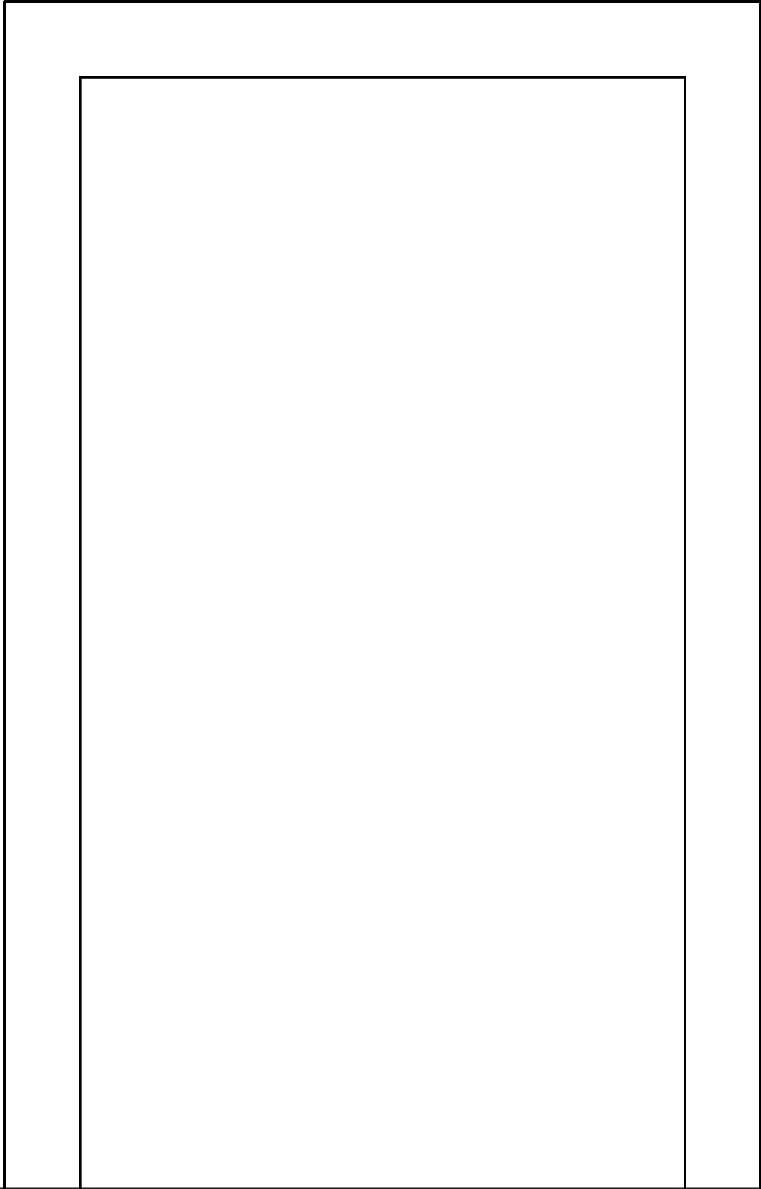

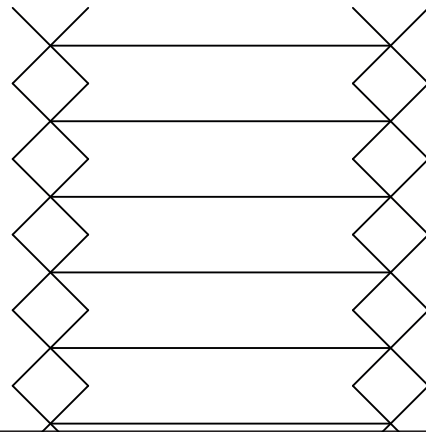

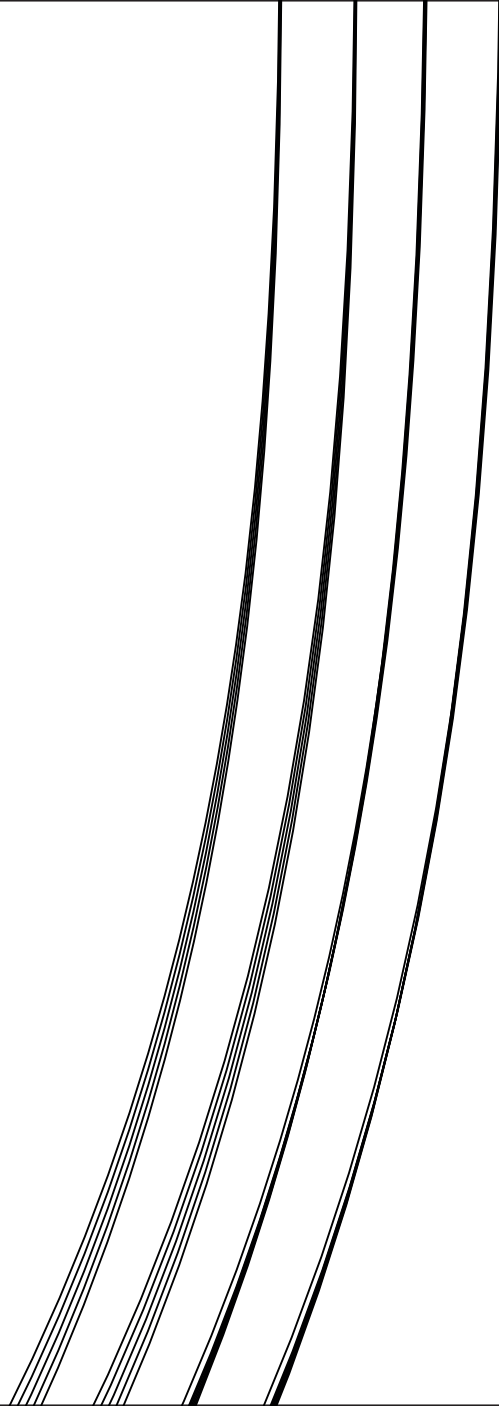

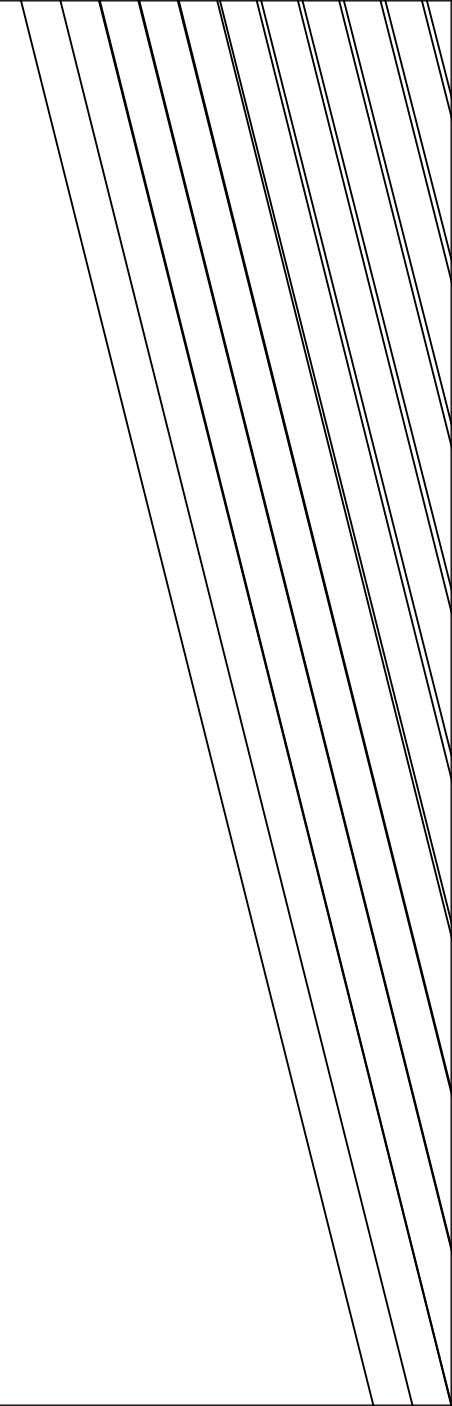

15

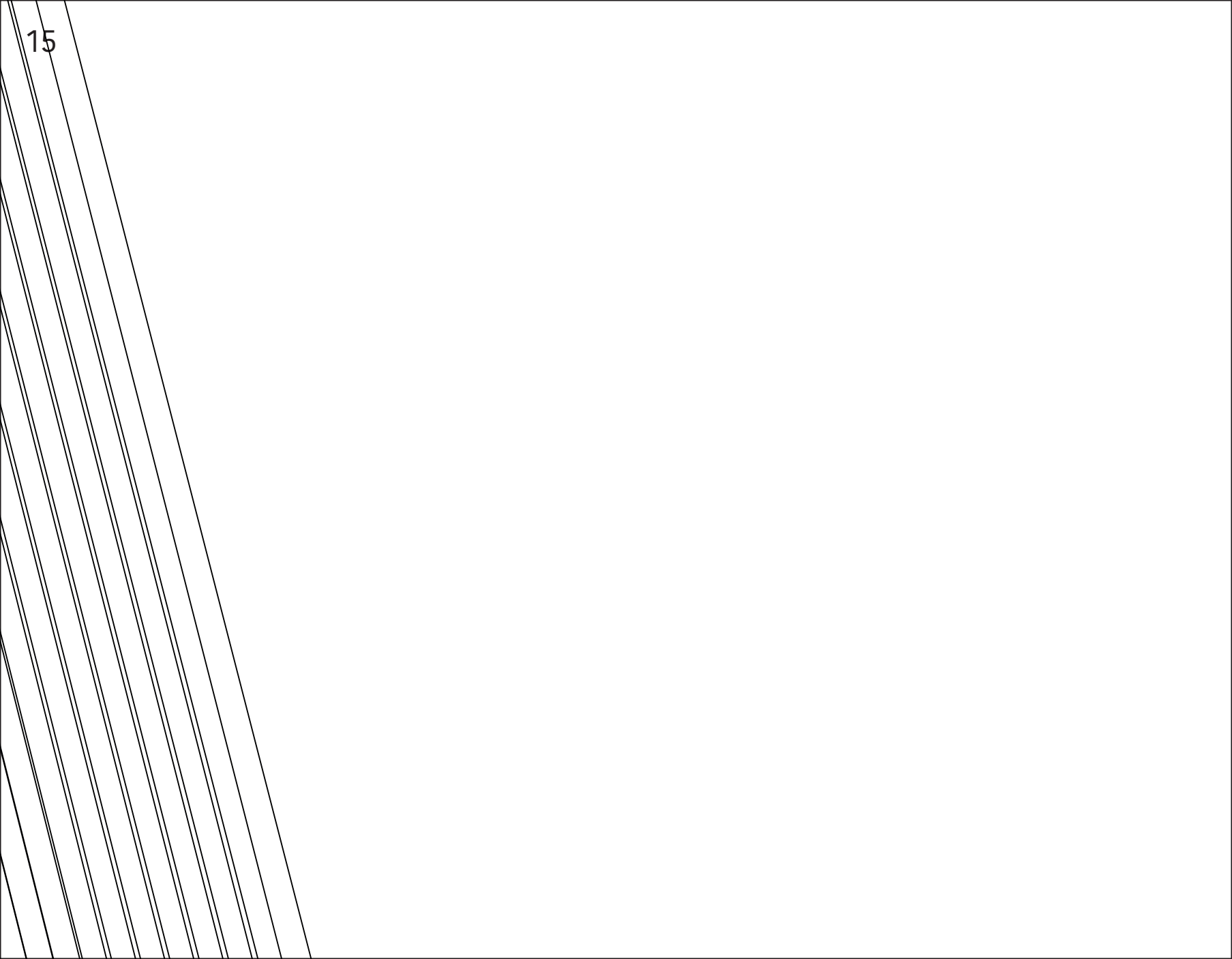

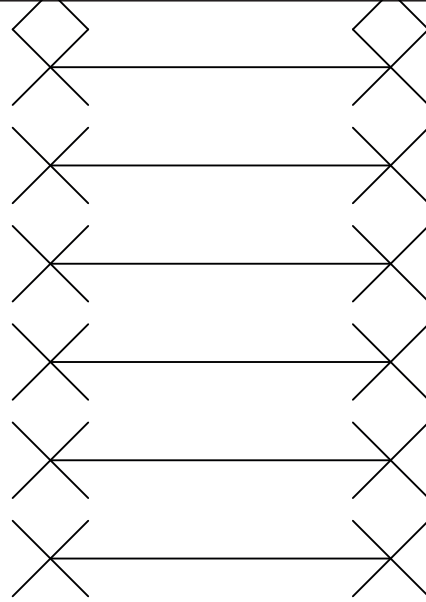

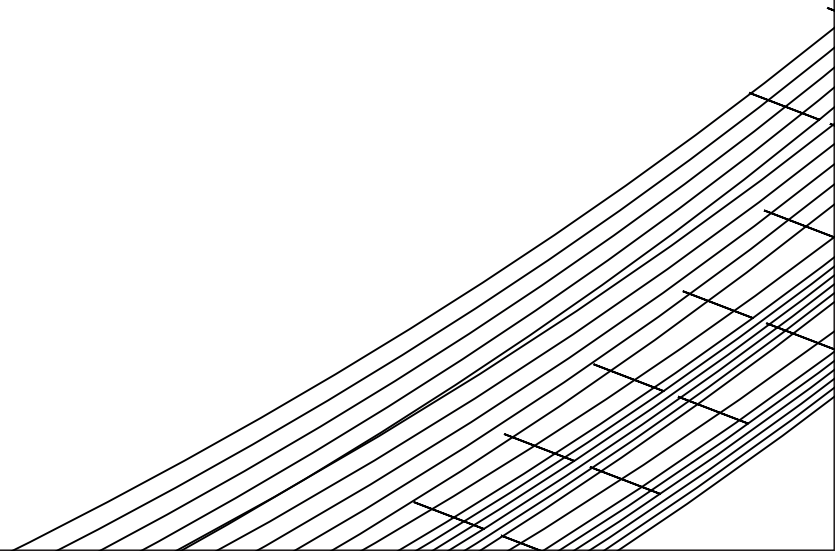

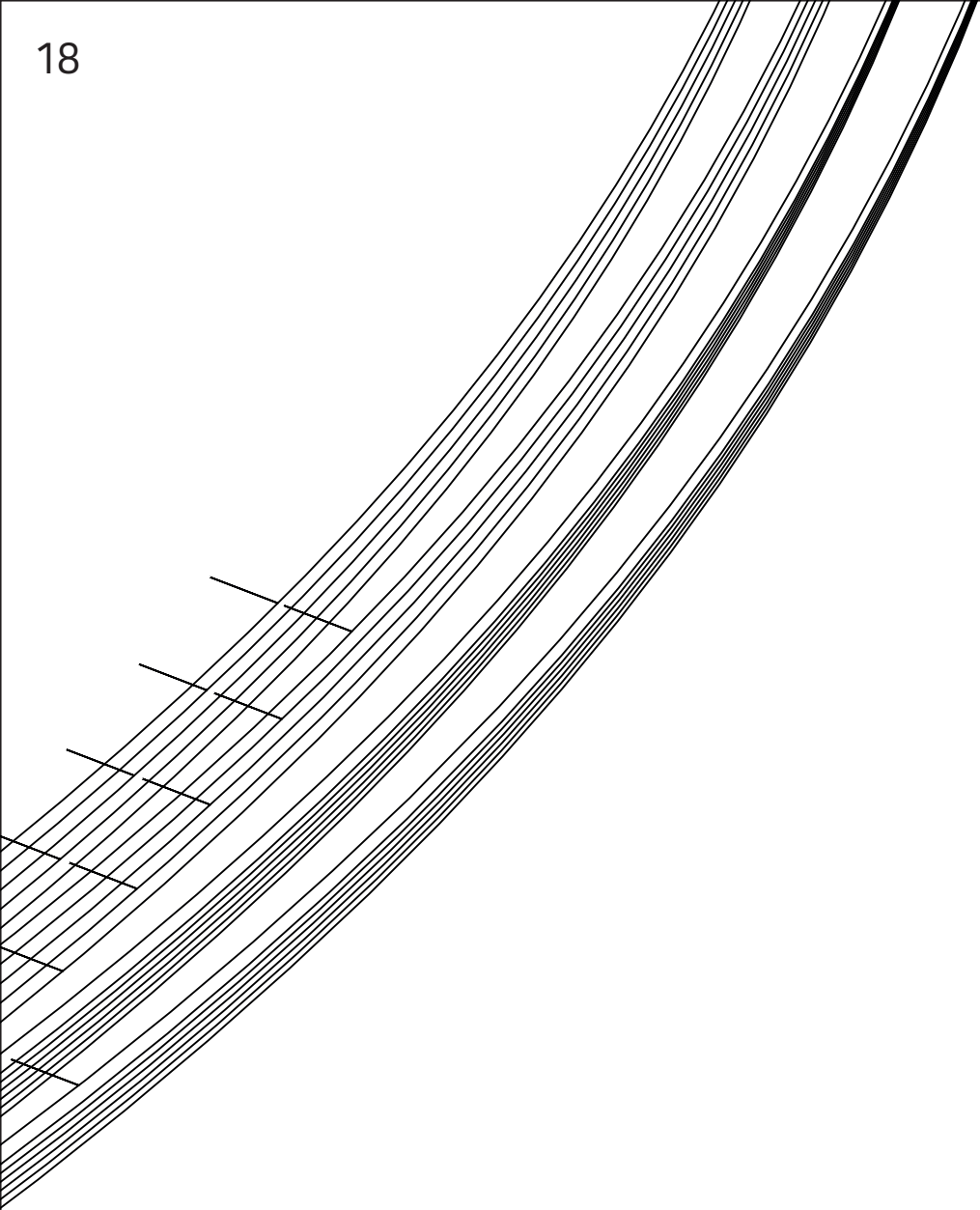





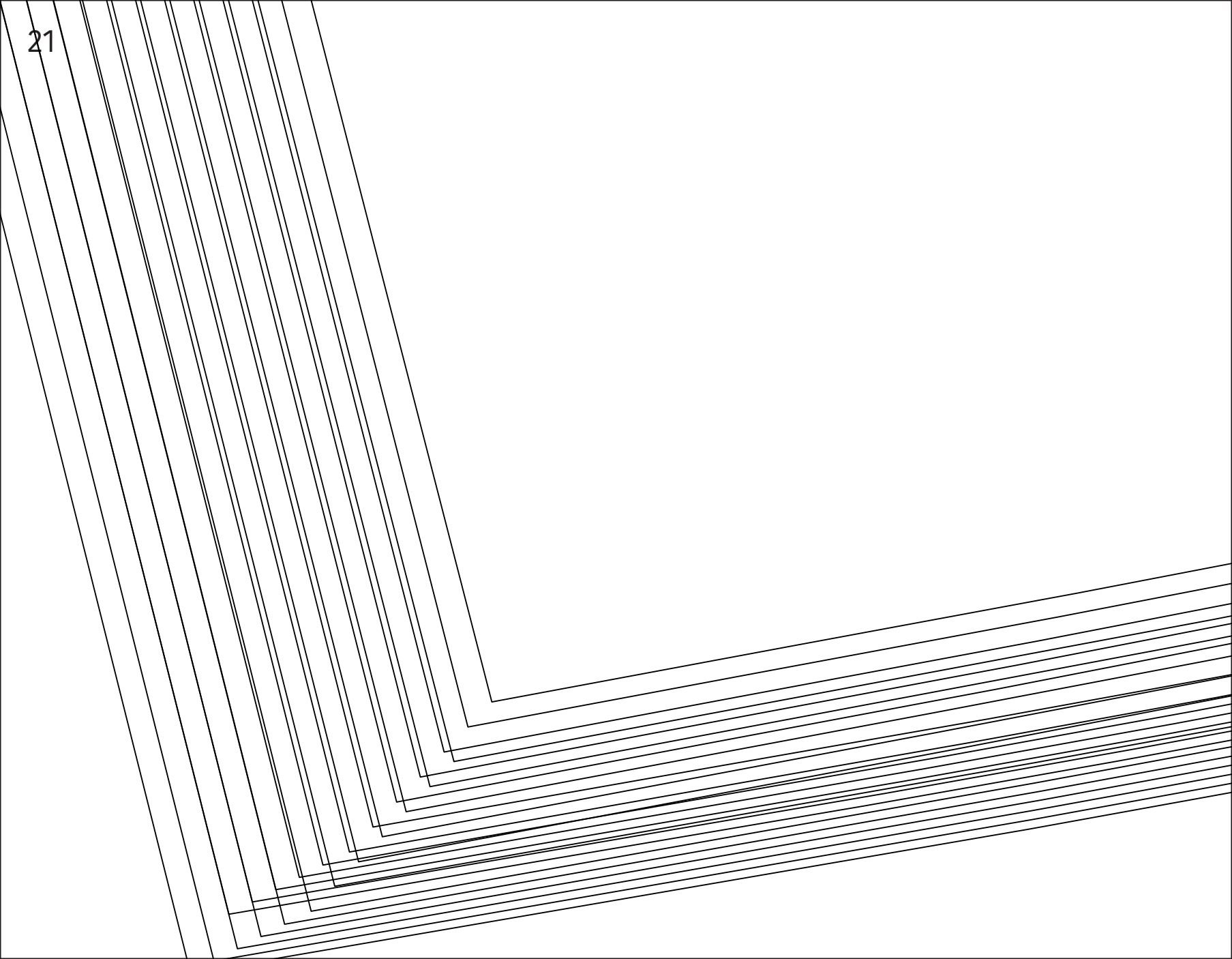

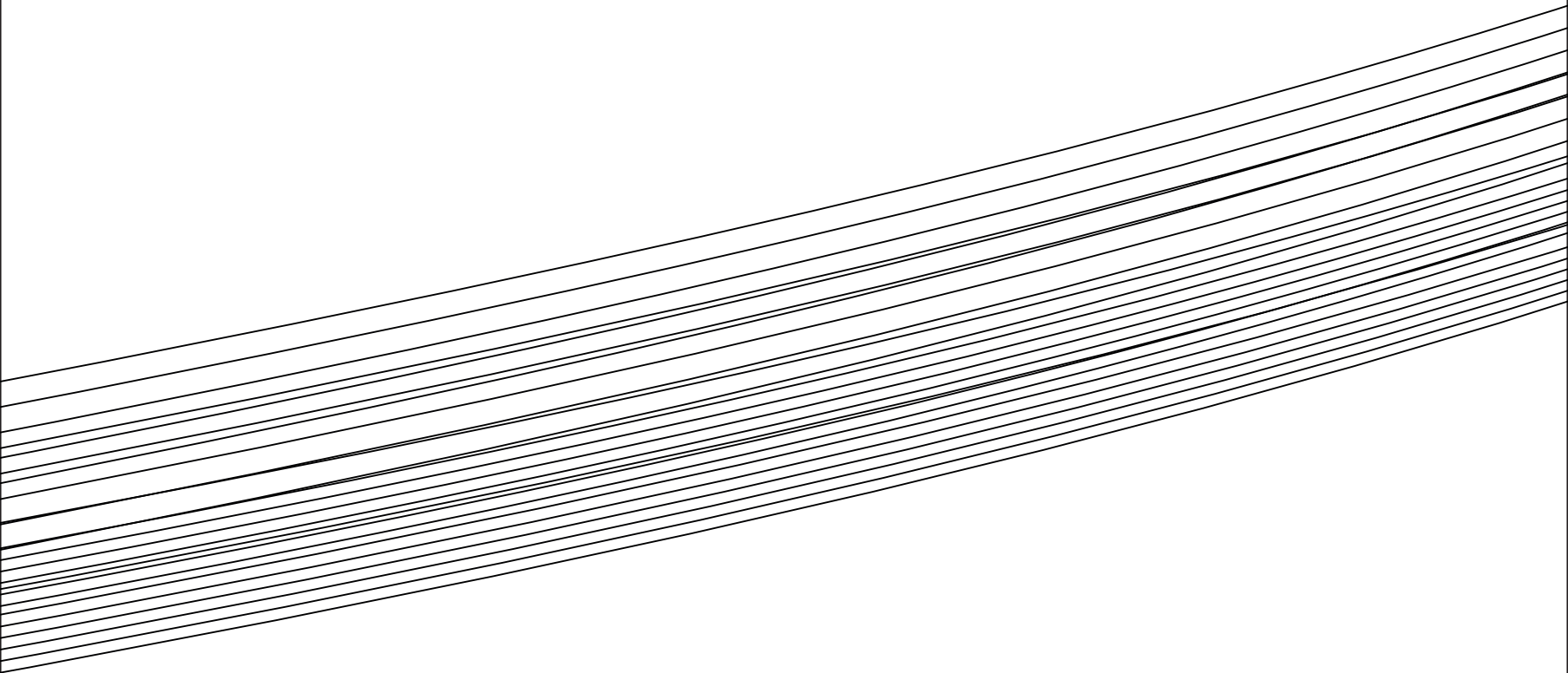

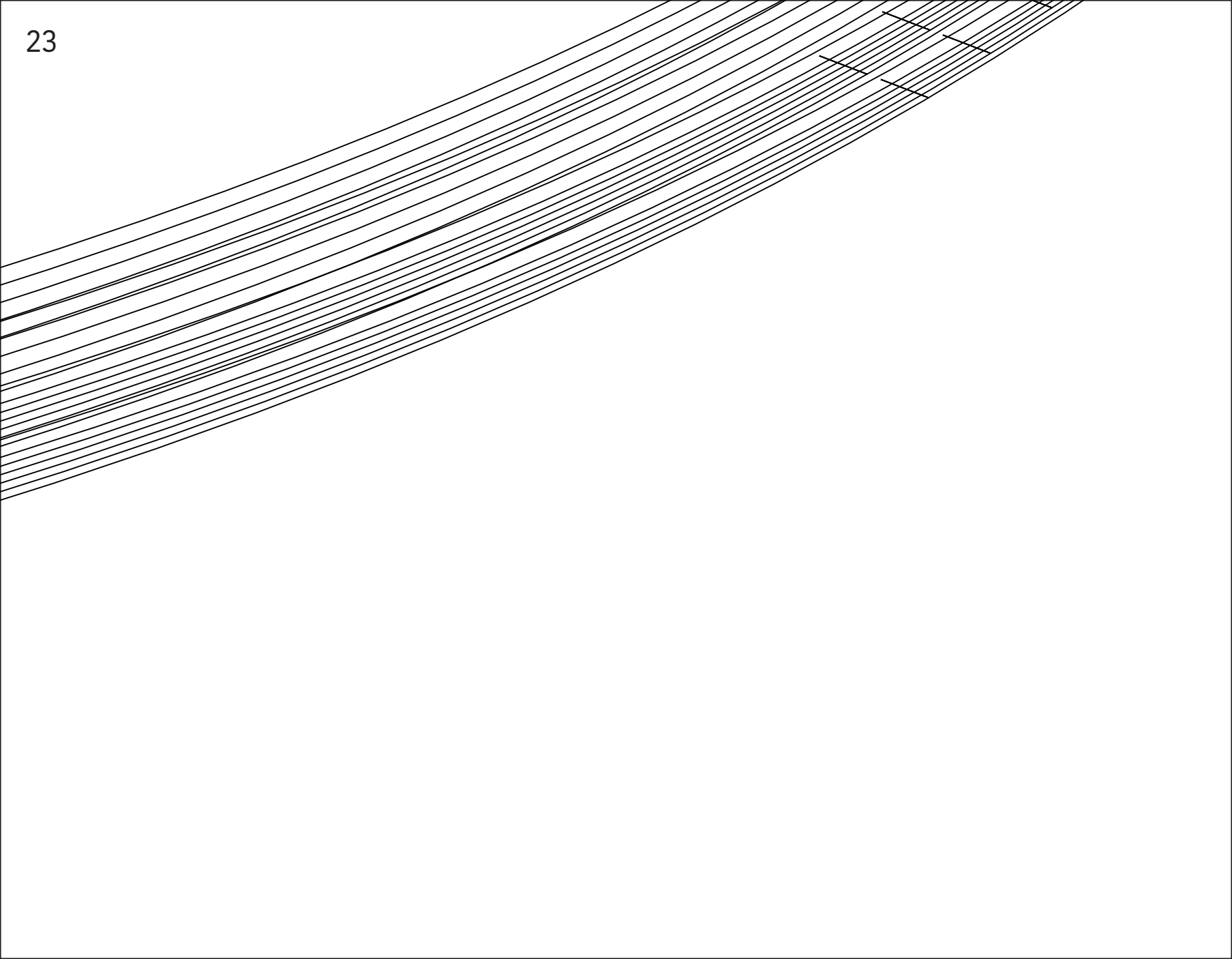

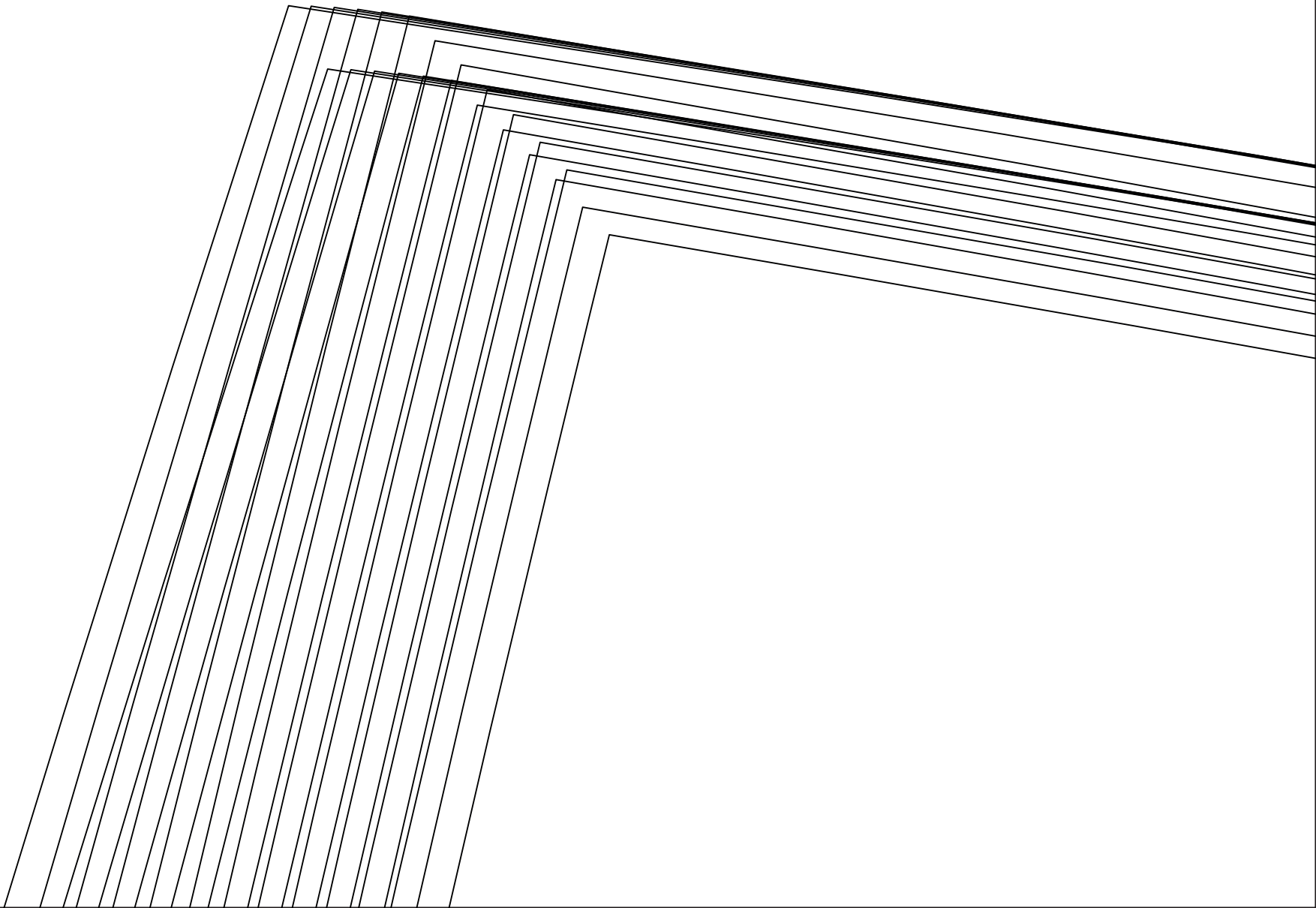

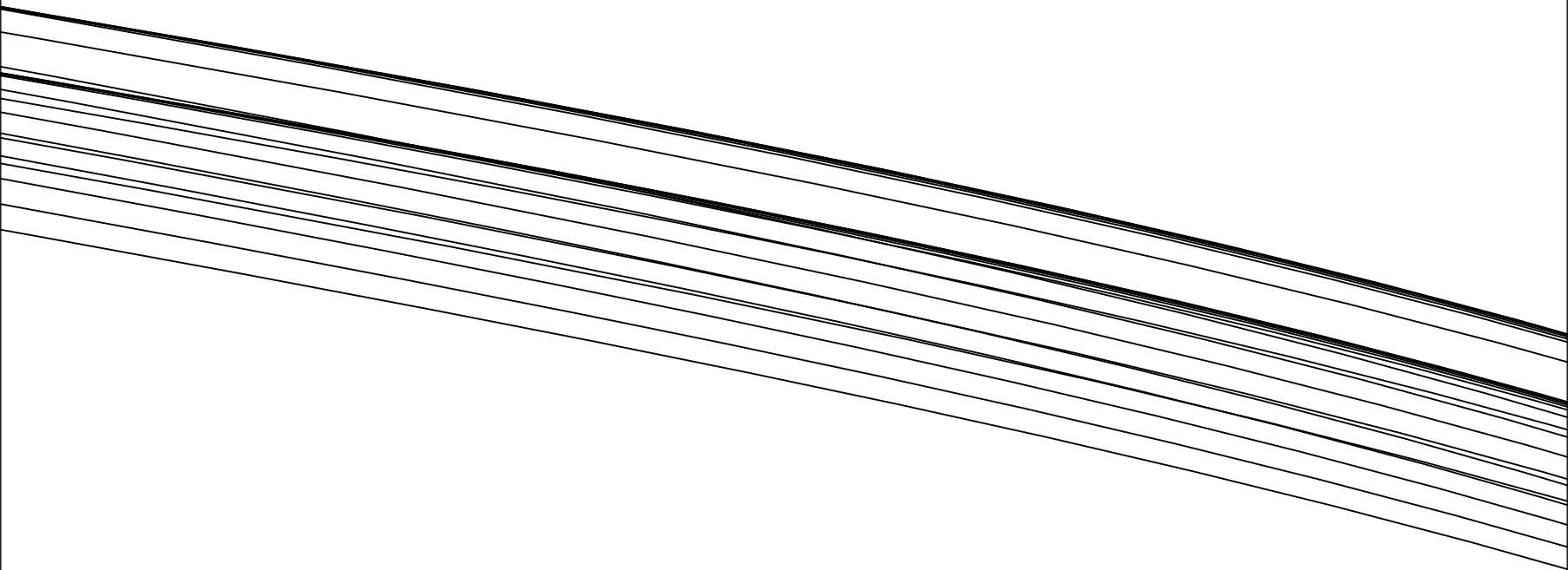

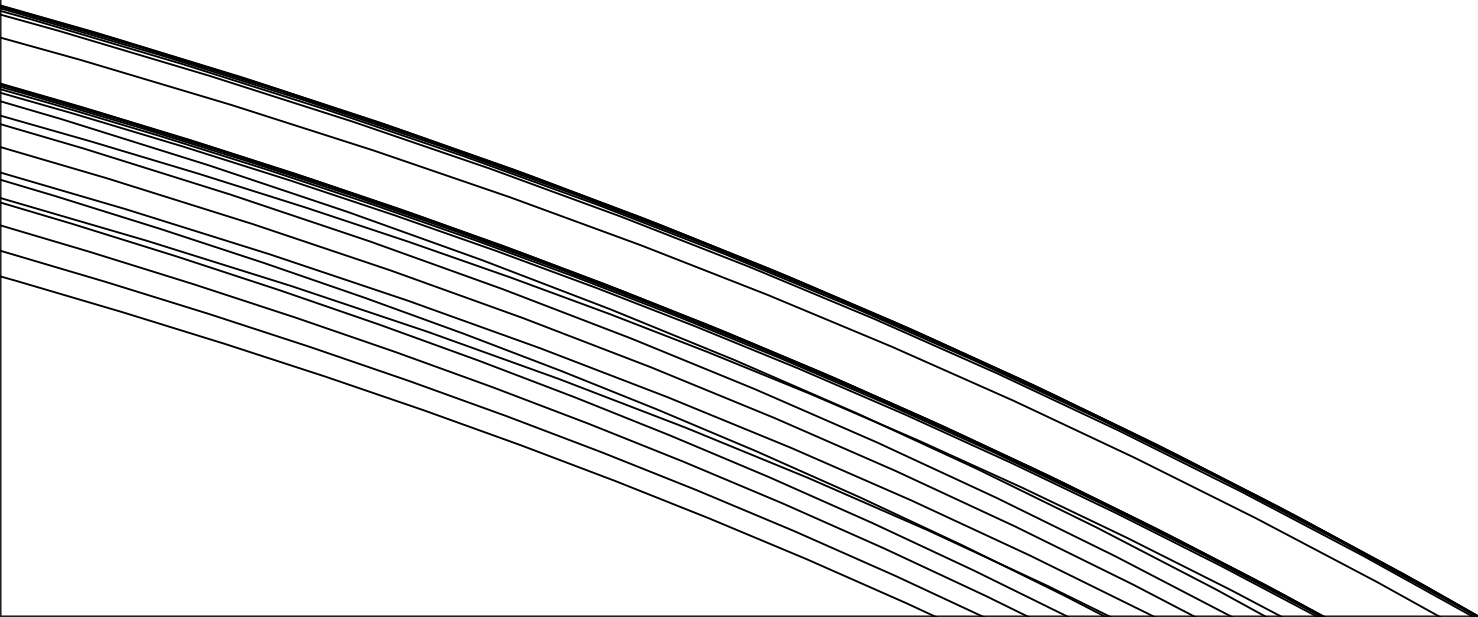

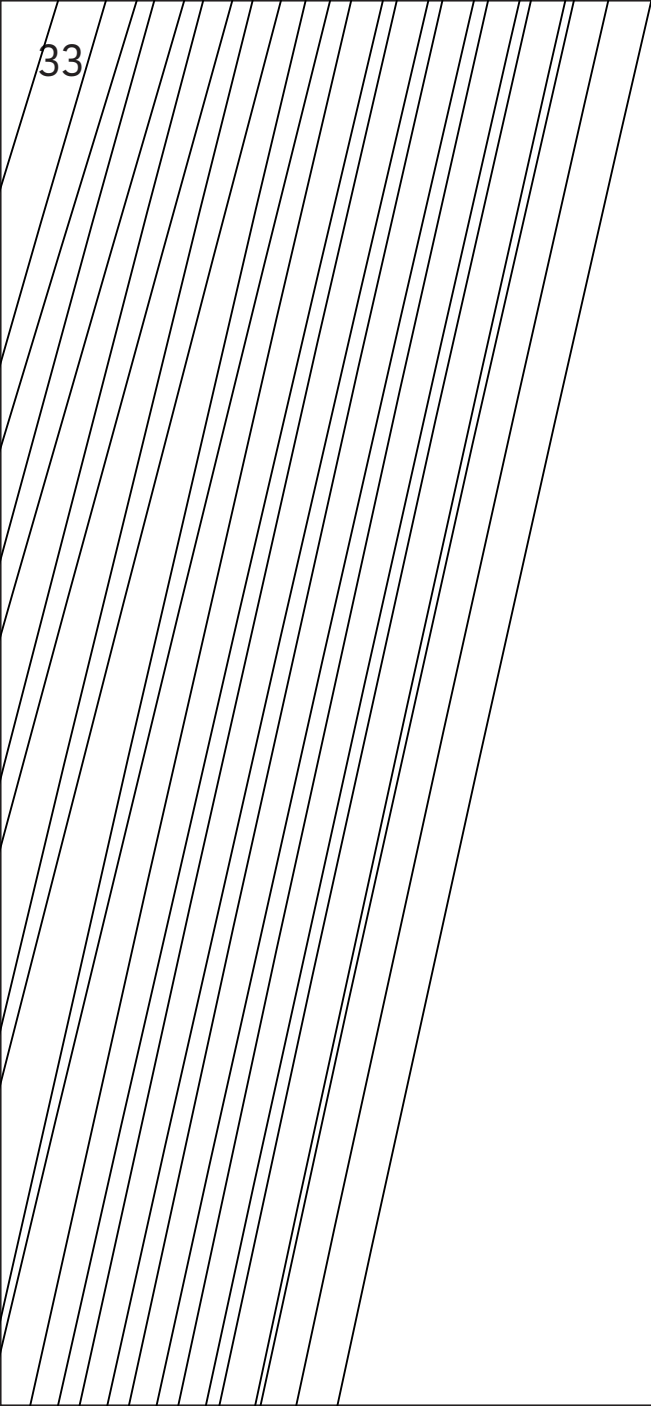

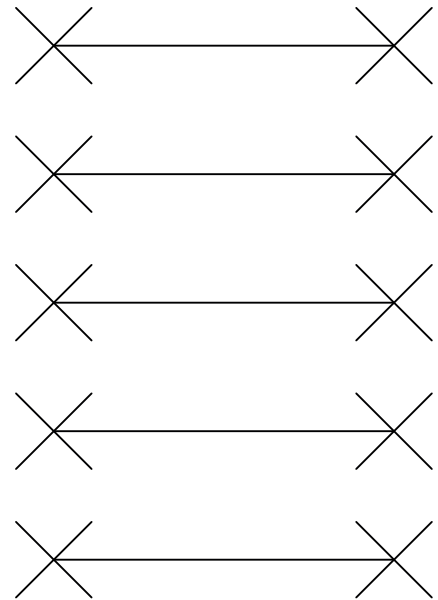

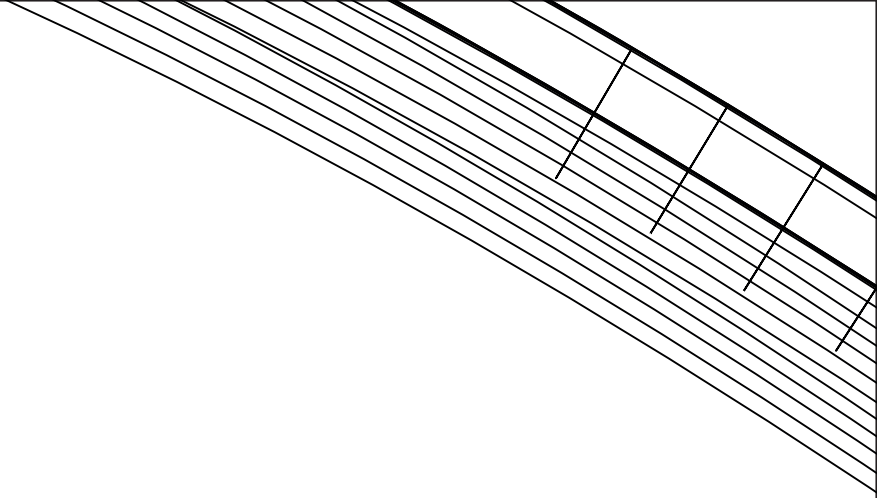

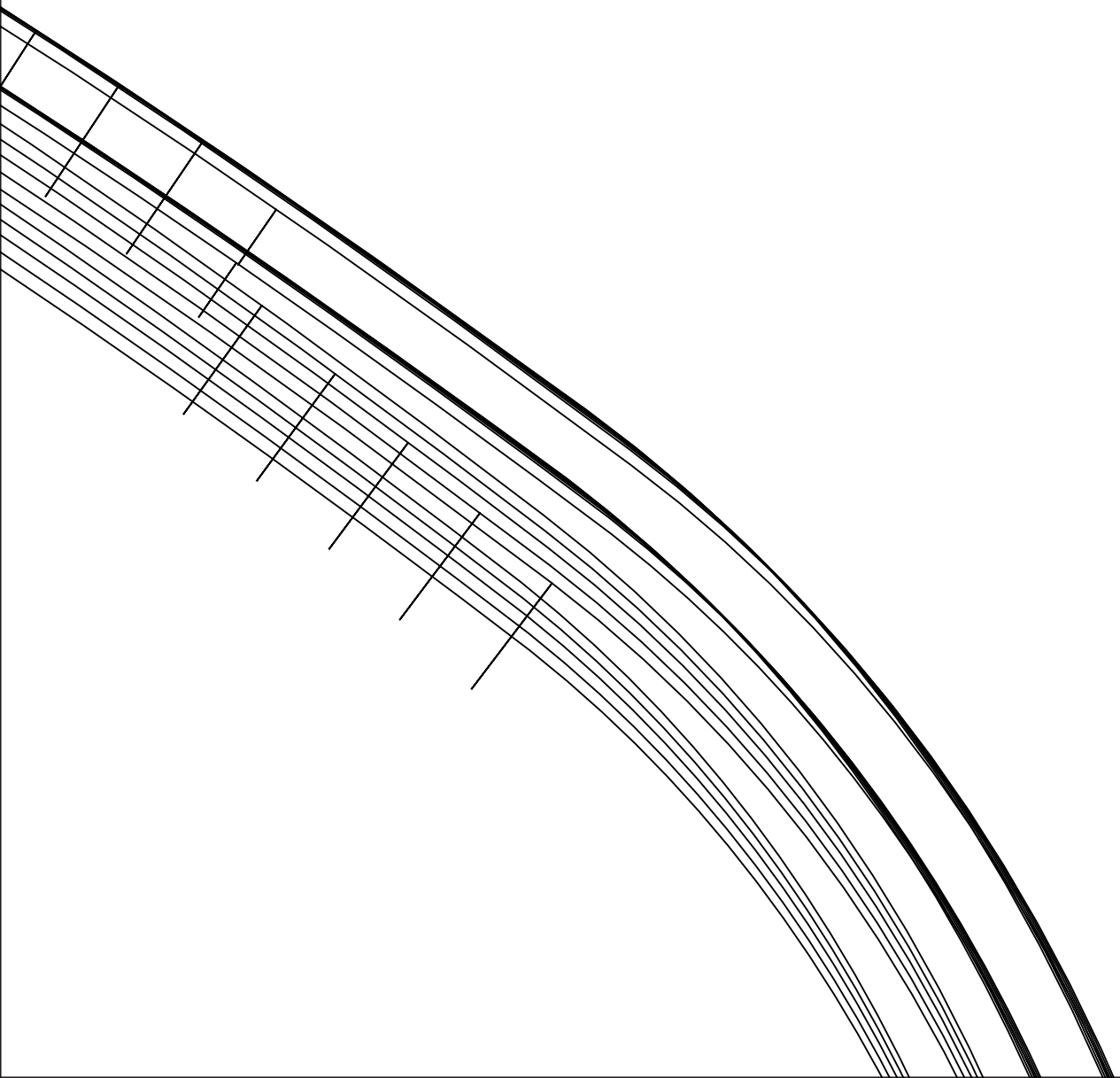

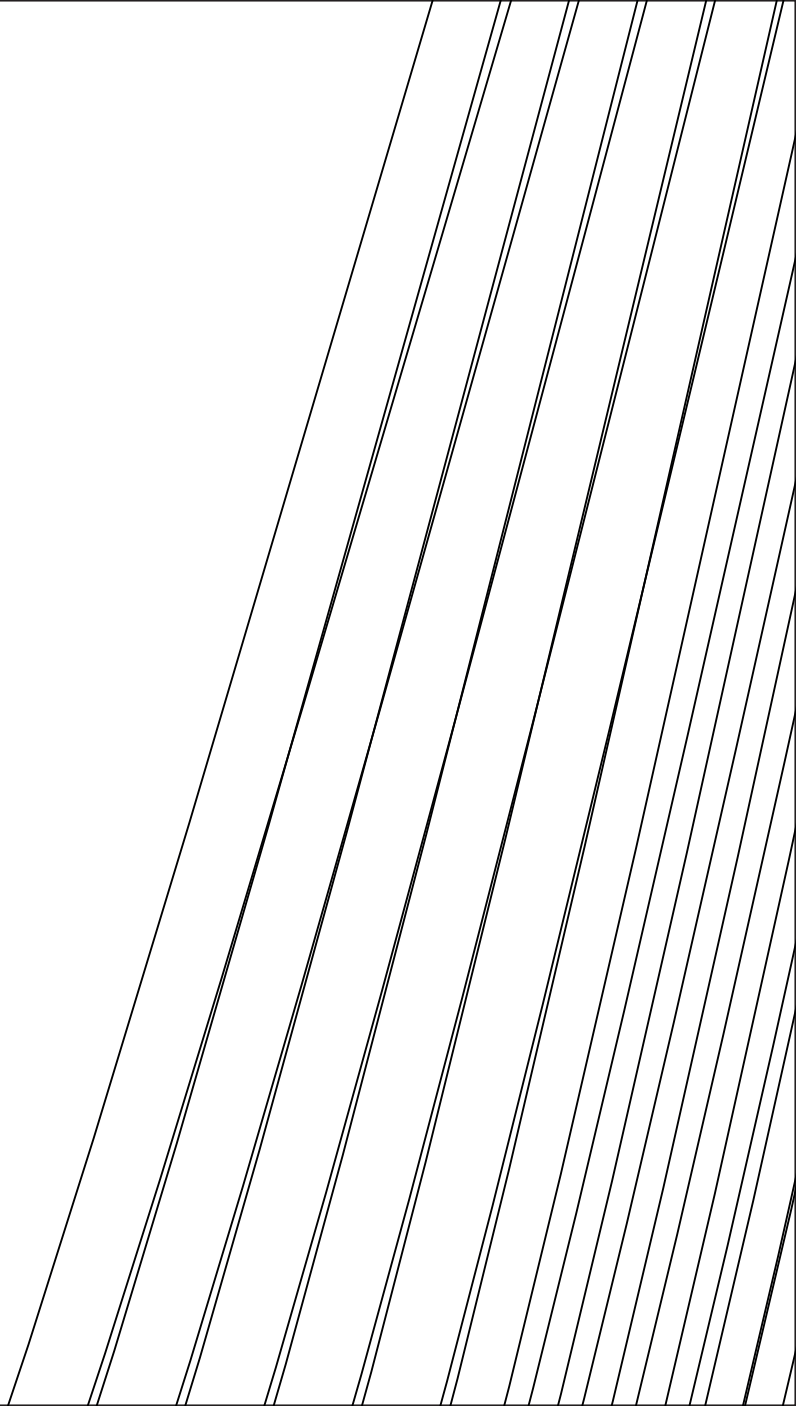

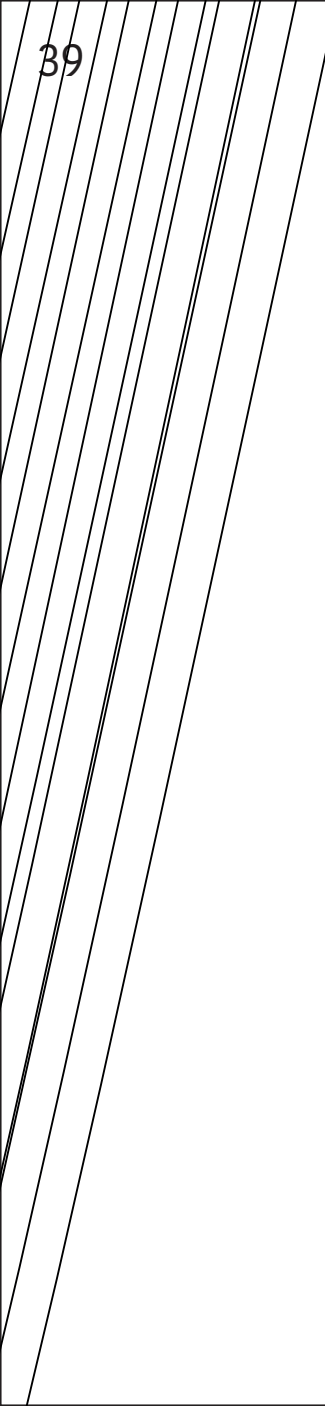

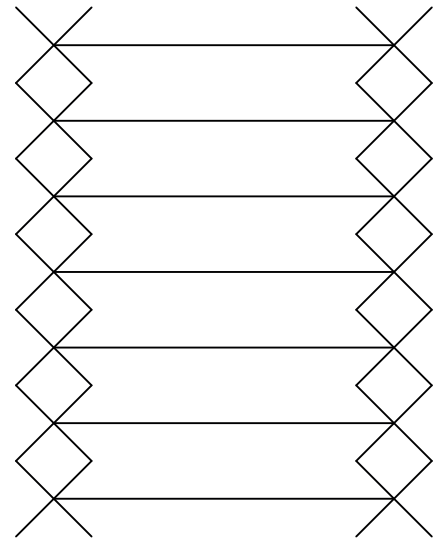

A

