

# Tindra

## Broek / Pantalon / Trousers / Hose

### Patroondelen / Pièces du patron / Pattern pieces / Schnittteile:

- A** rechtervoorpannd / devant droit /  
right front panel / rechtes Vorderteil
- B** linkervoorpannd / devant gauche /  
left front panel / linkes Vorderteil
- C** rugpannd / dos / back panel /  
Rückenteil
- D** tailleband VP / ceinture DV /  
waistband FP / Bund VT
- E** tailleband RP / ceinture DS /  
waistband BP / Bund RT

Patroonschema / Schéma du Patron / Pattern Diagram /  
Übersichtsplan zum Zusammenkleben

1	2	3	4	5	6
7	8	9	10	11	12
13	14	15	16	17	18
19	20	21	22	23	24
25	26	27	28	29	30
31	32	33	34	35	36
37	38	39	40	41	

Controlevierkant / Carré de controle  
/ Test square / Kontrollquadrat

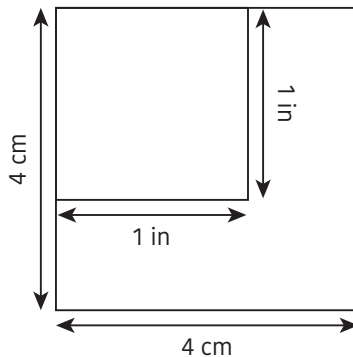

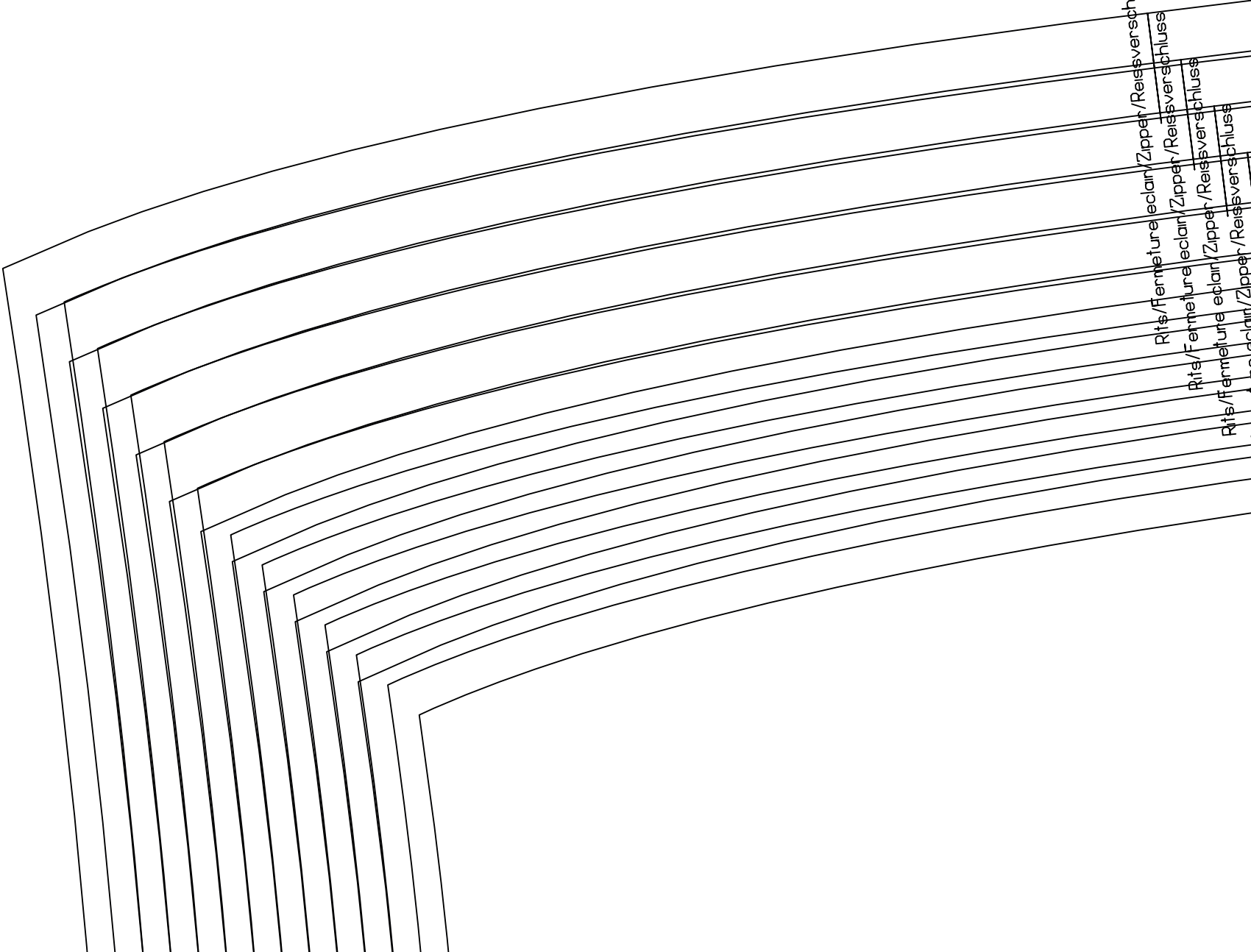

Rits/Fermeture éclair/Zipper/Reissverschluss

Rits/Fermeture éclair/Zipper/Reissverschluss

Rits/Fermeture éclair/Zipper/Reissverschluss

Rits/Fermeture éclair/Zipper/Reissverschluss

Rits/Fermeture éclair/Zipper/Reissverschluss



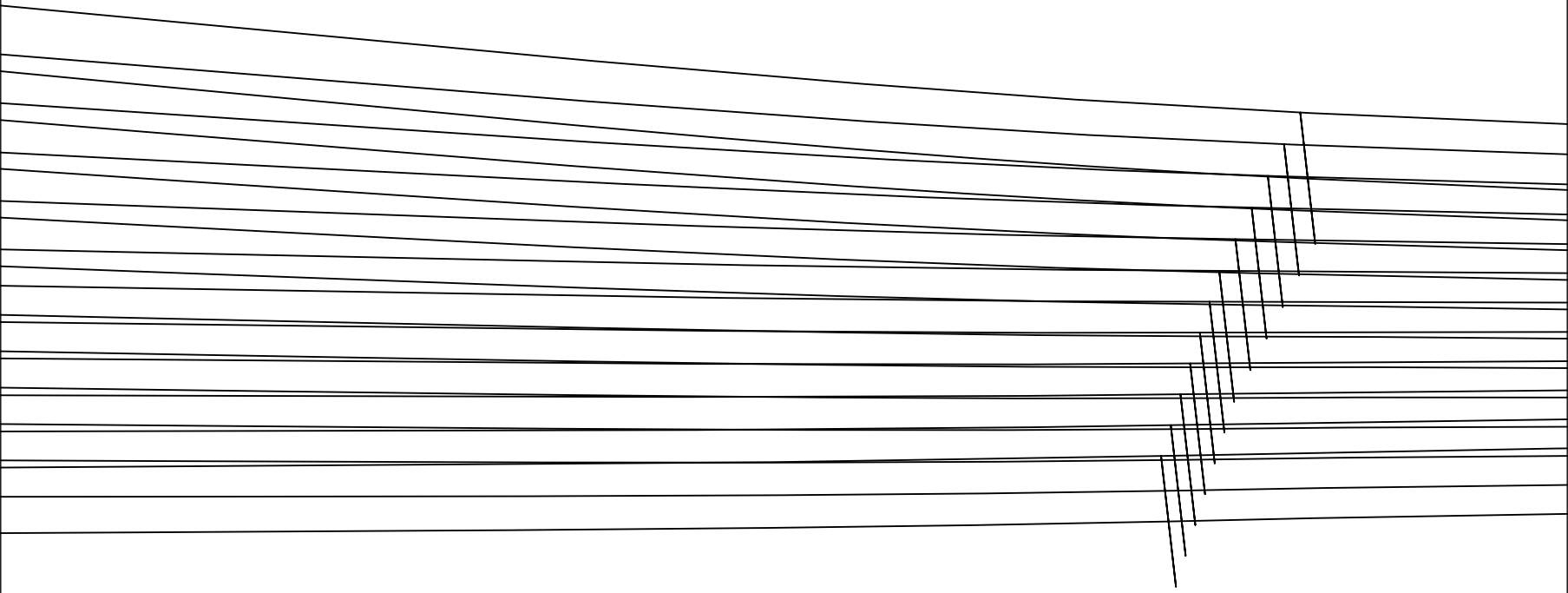

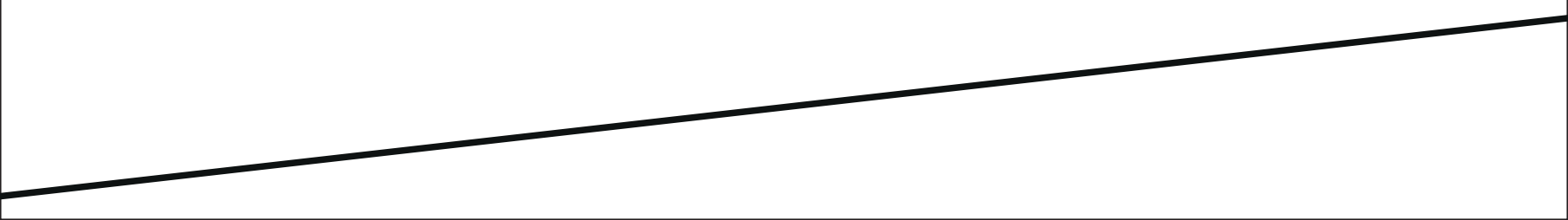
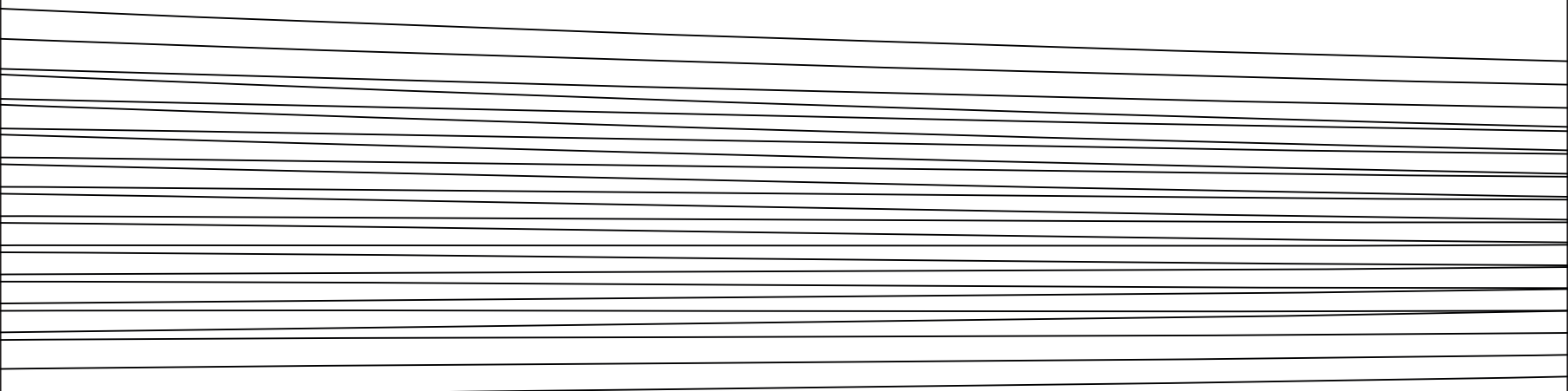

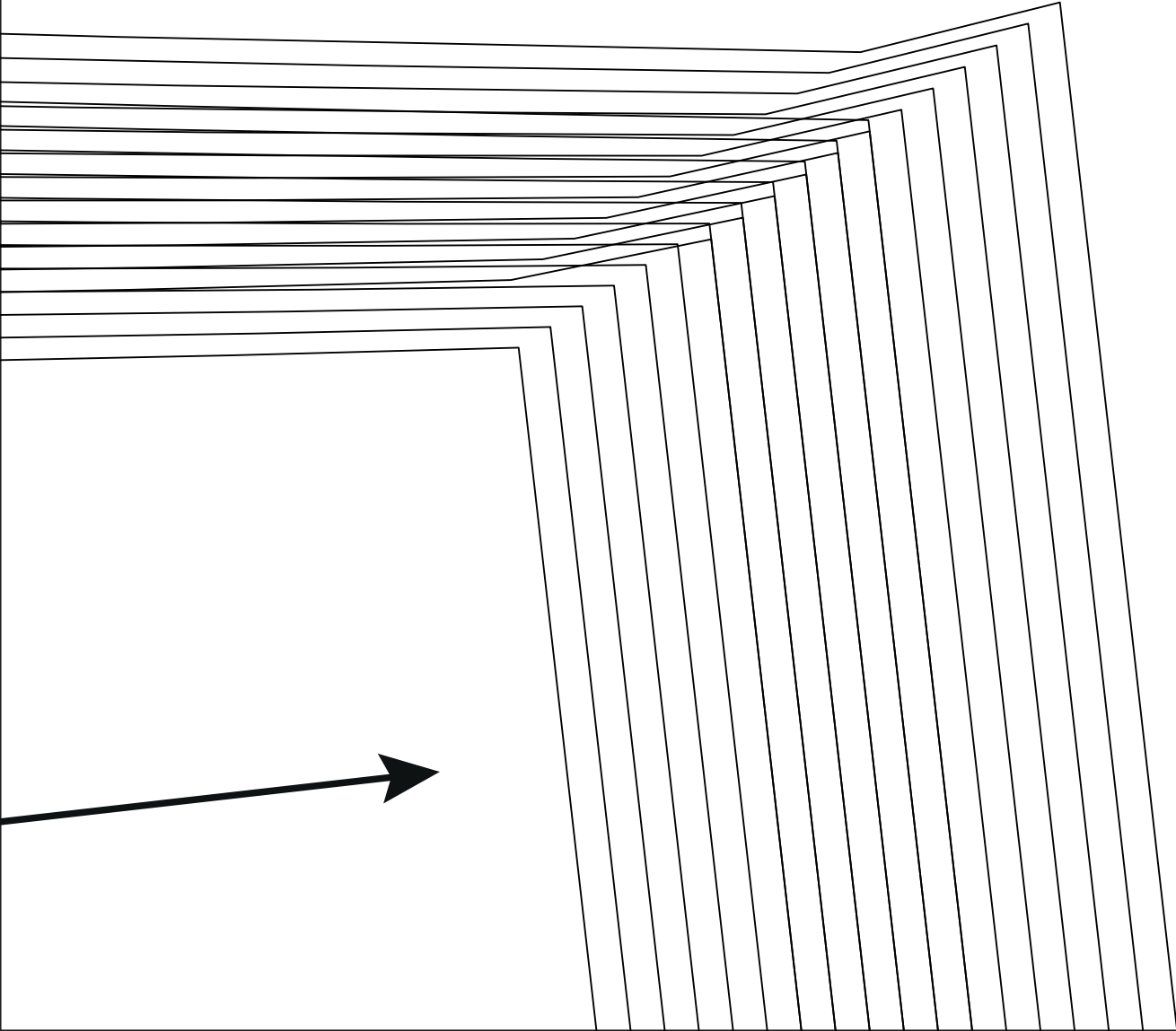

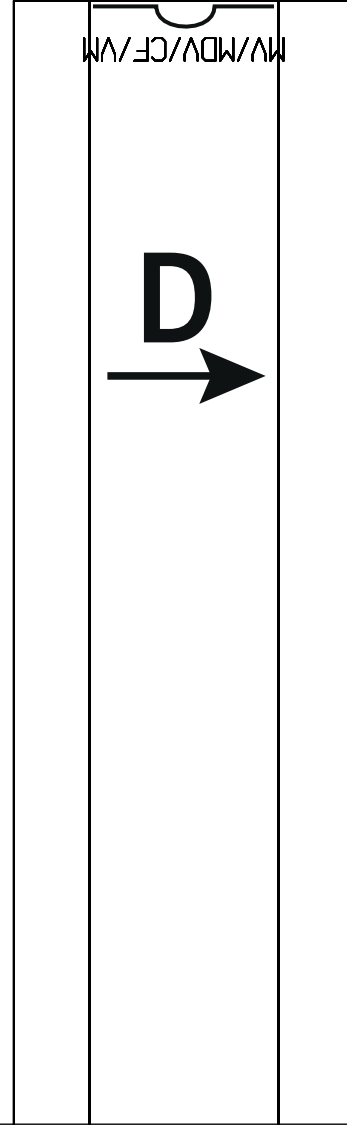
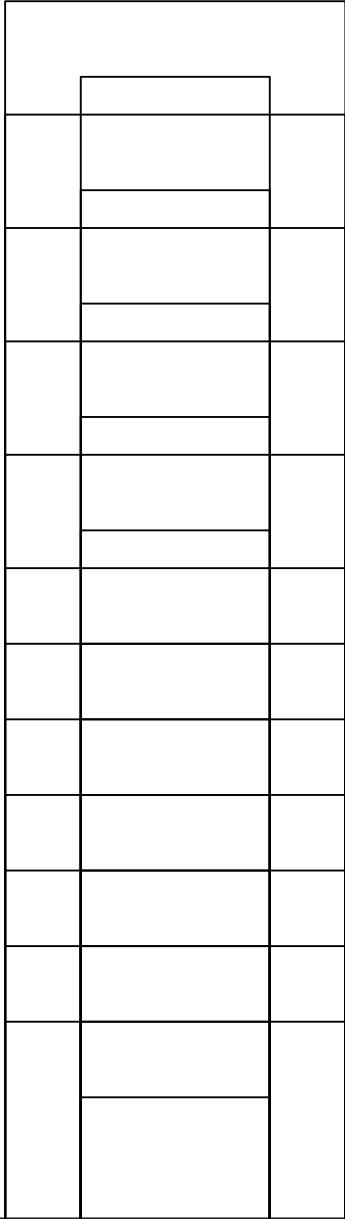





C

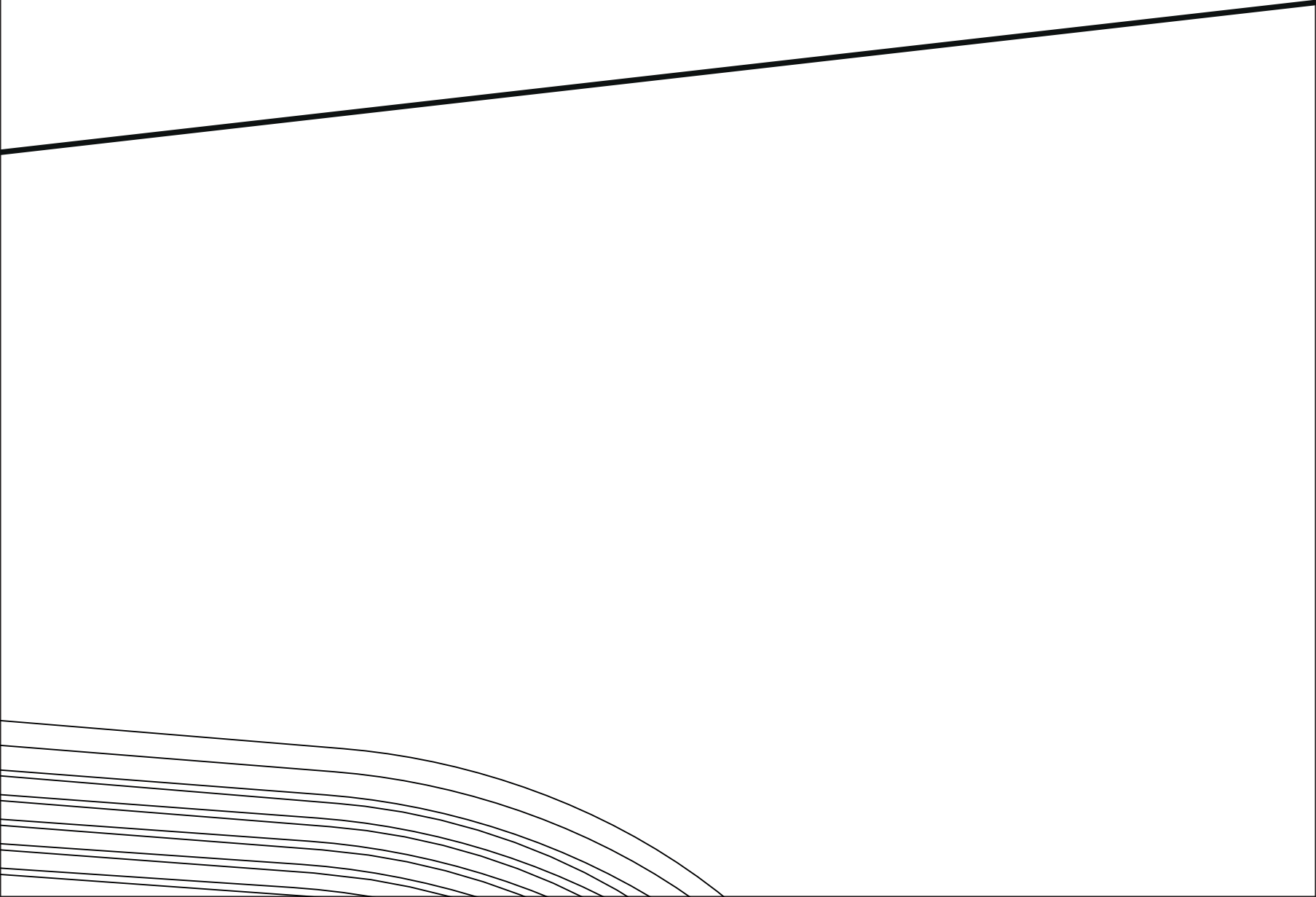

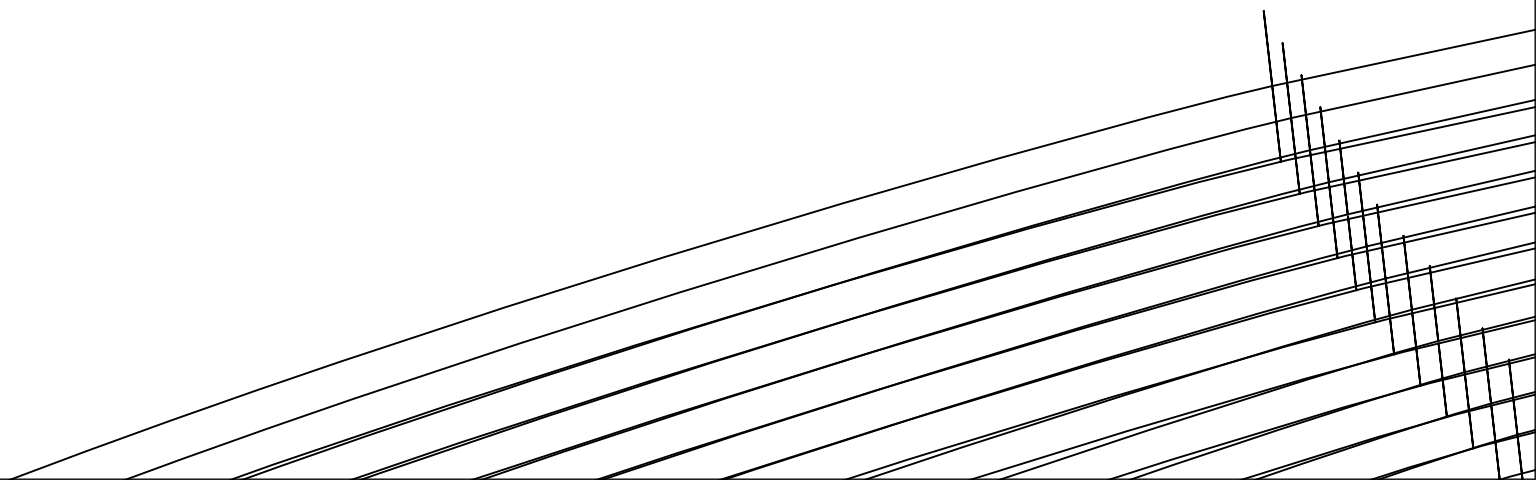

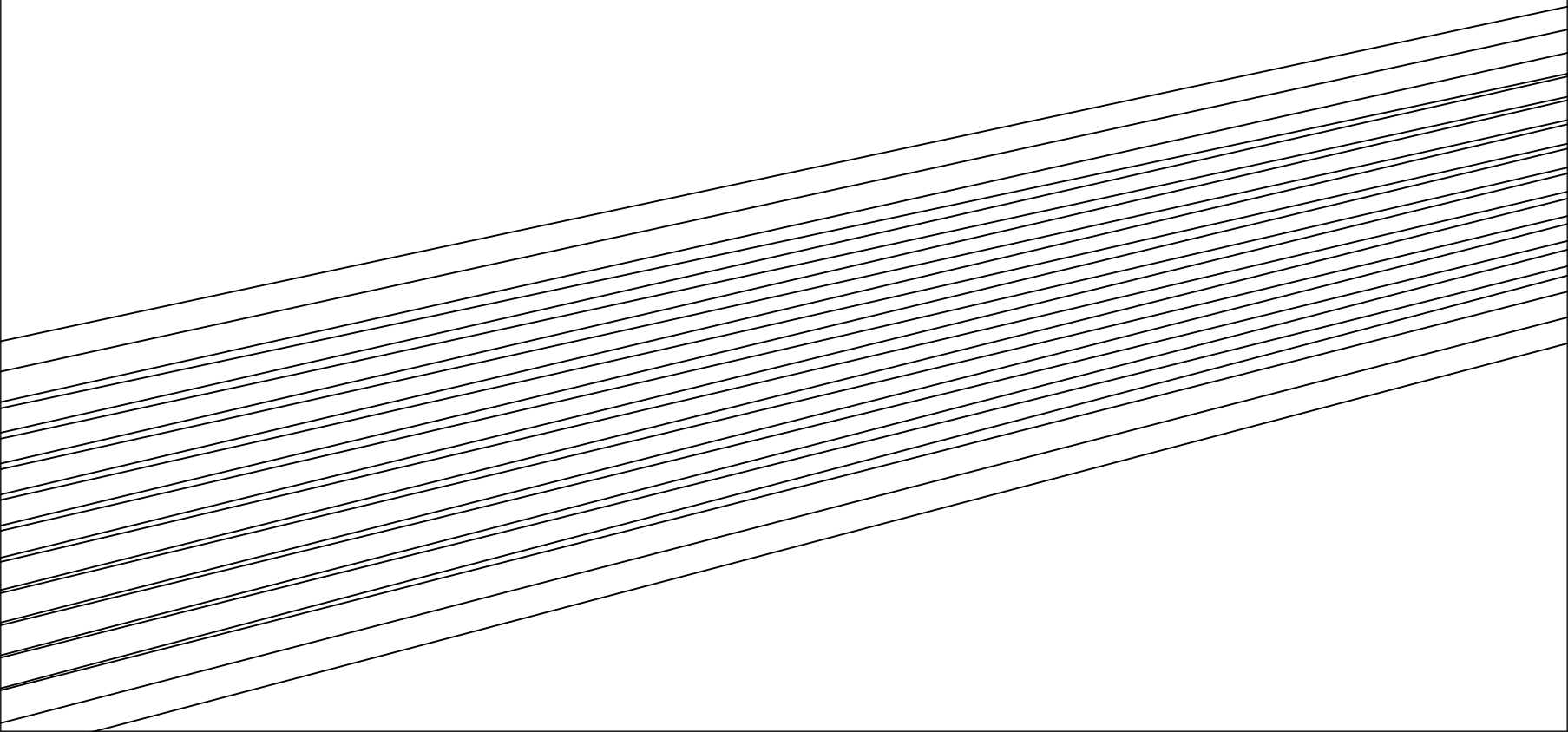

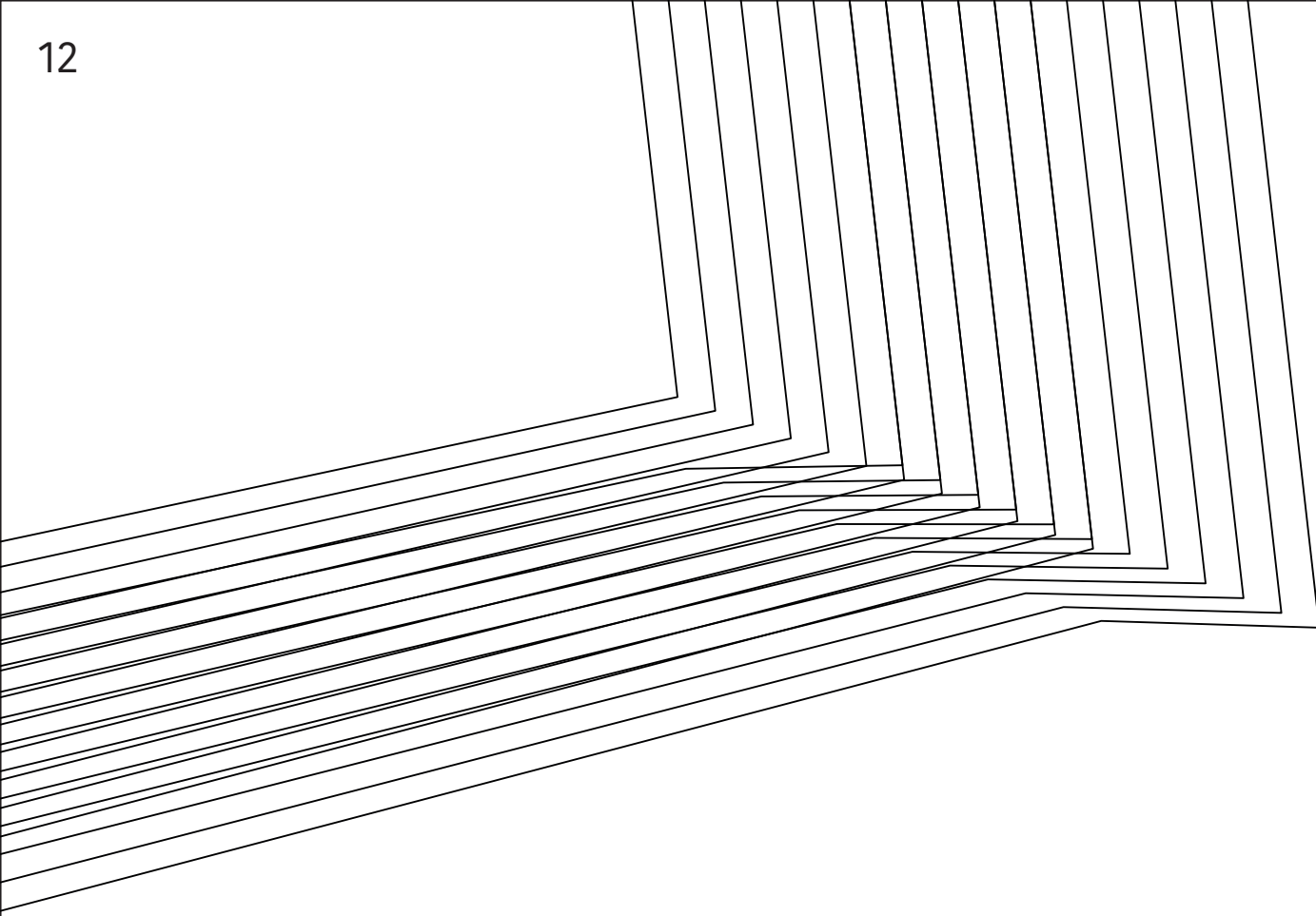



MR/MDS/CB/RM  
MR/MDS/CB/RM  
MR/MDS/CB/RM  
MR/MDS/CB/RM

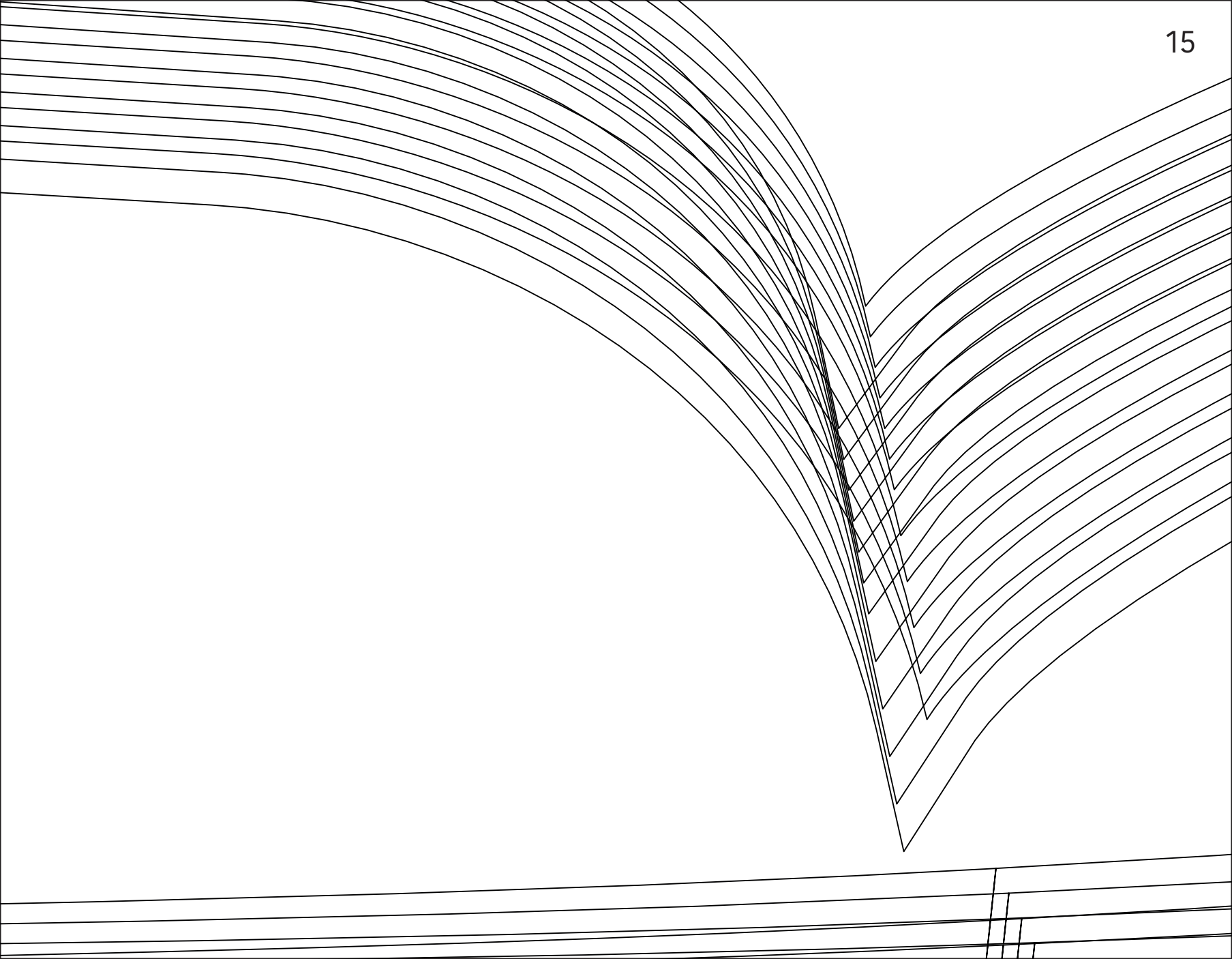

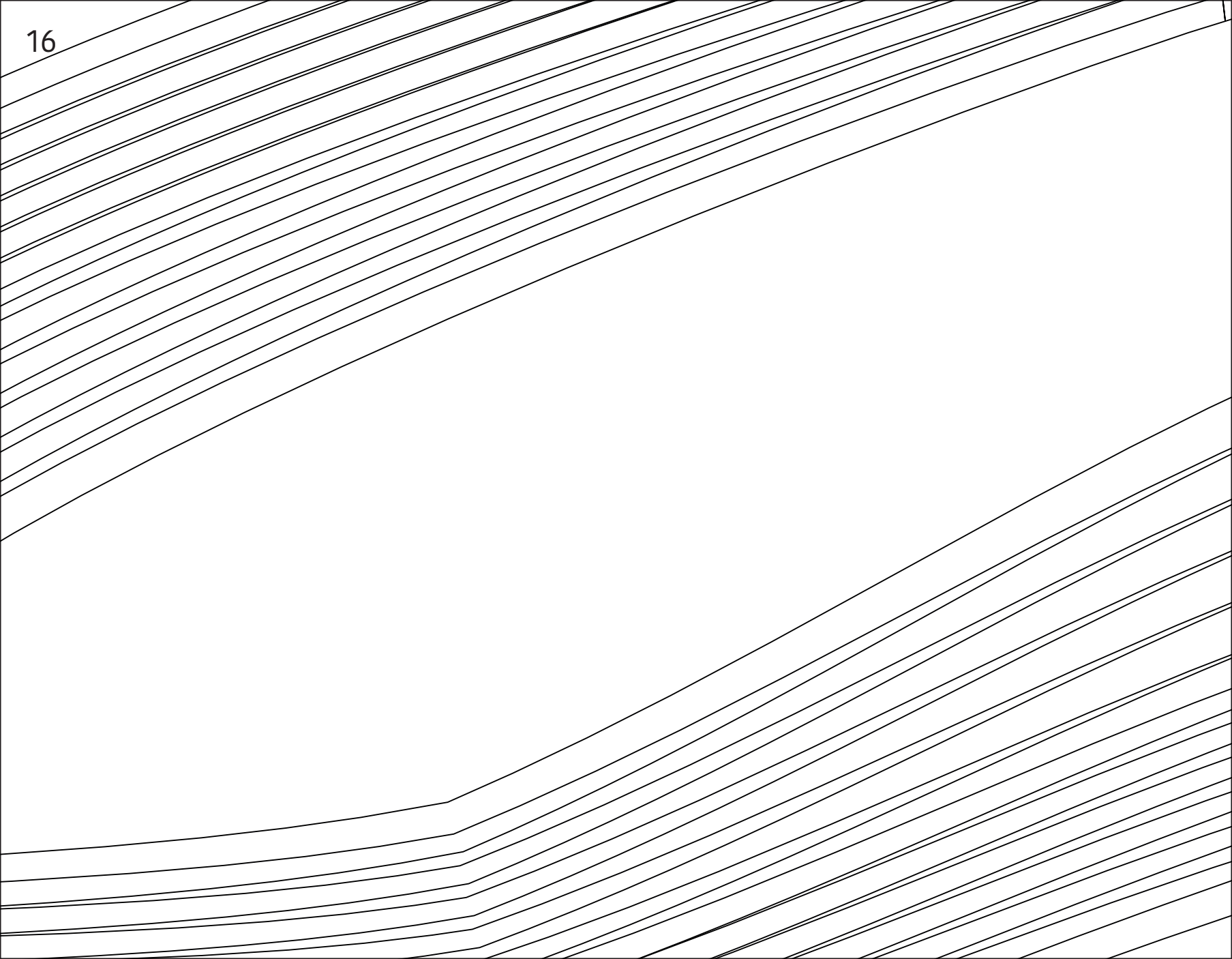



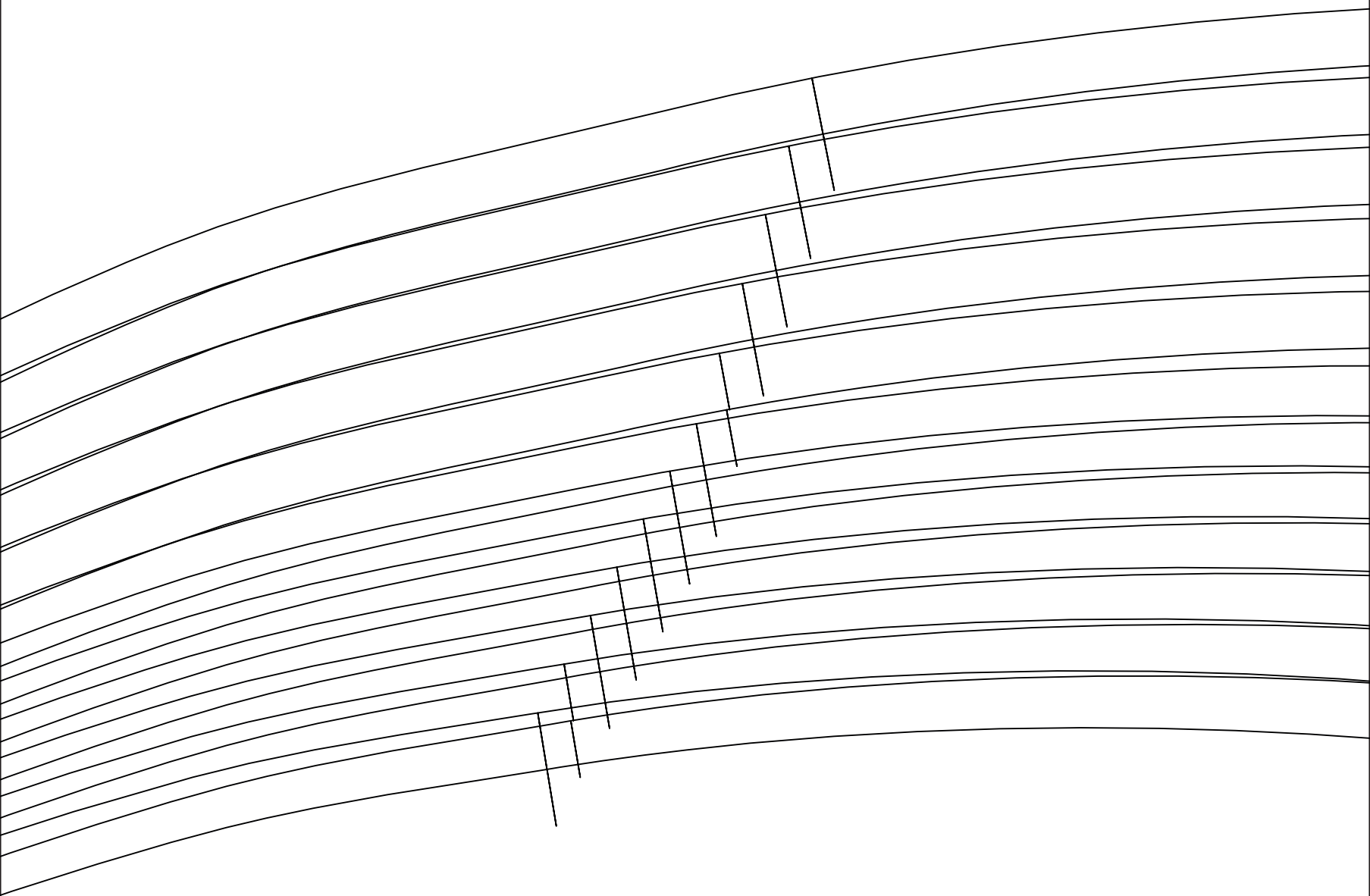

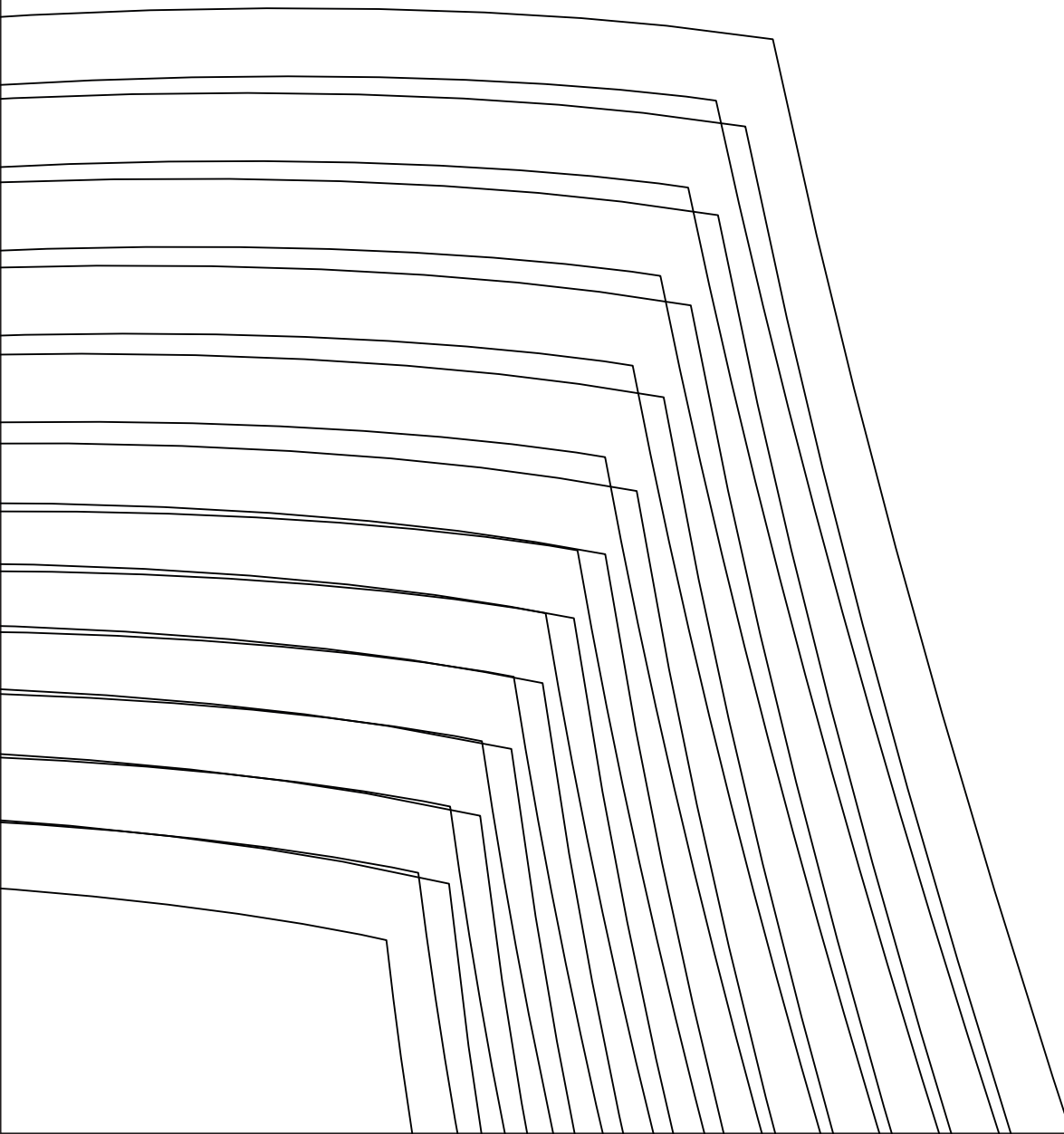

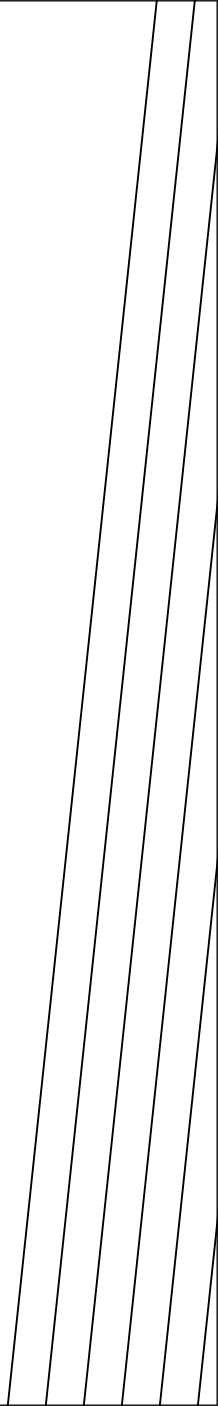

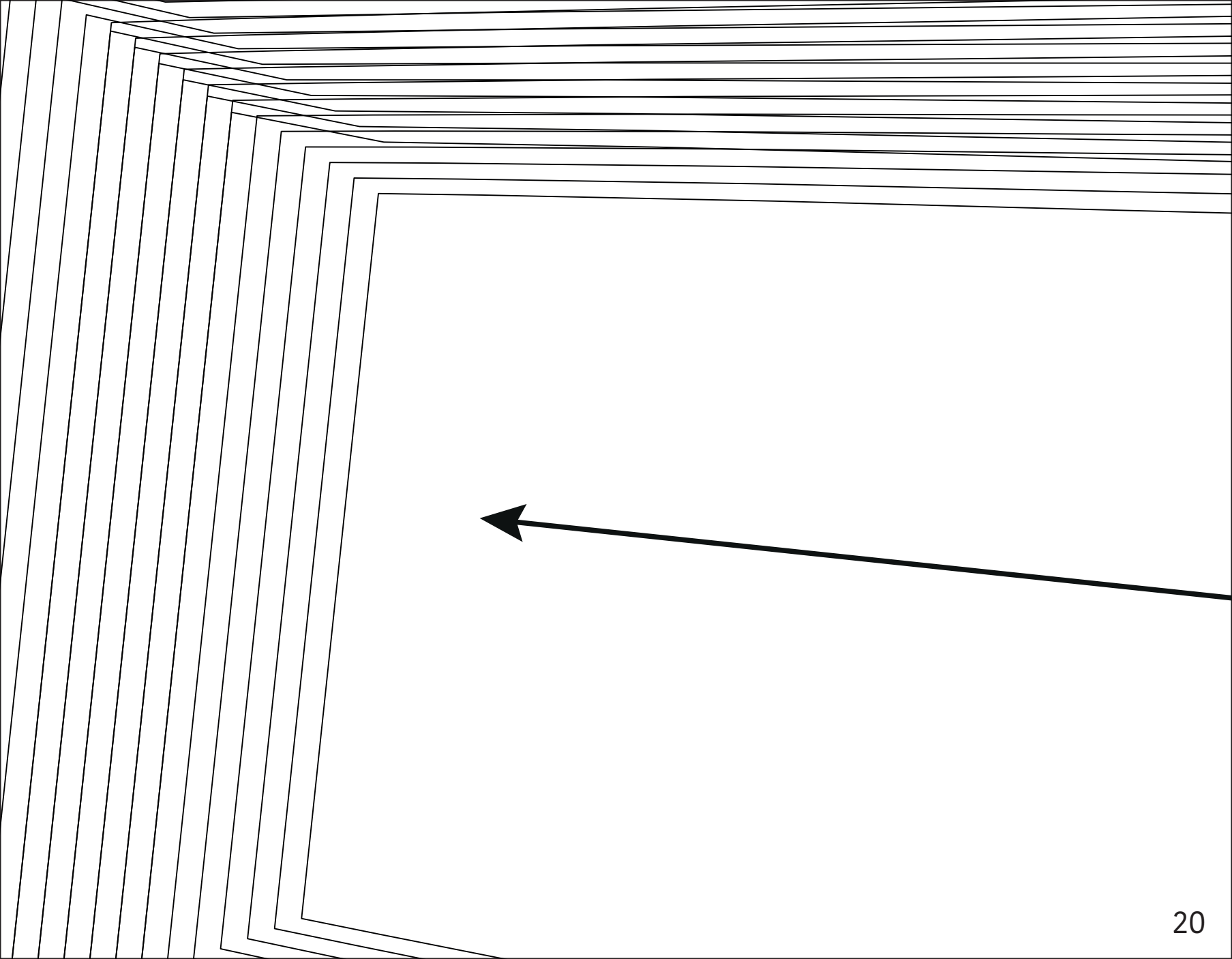

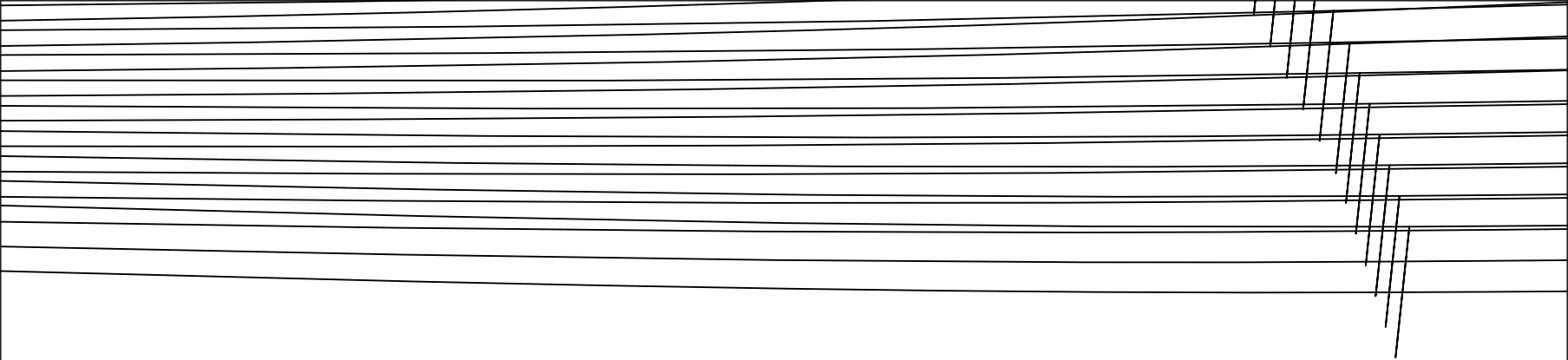

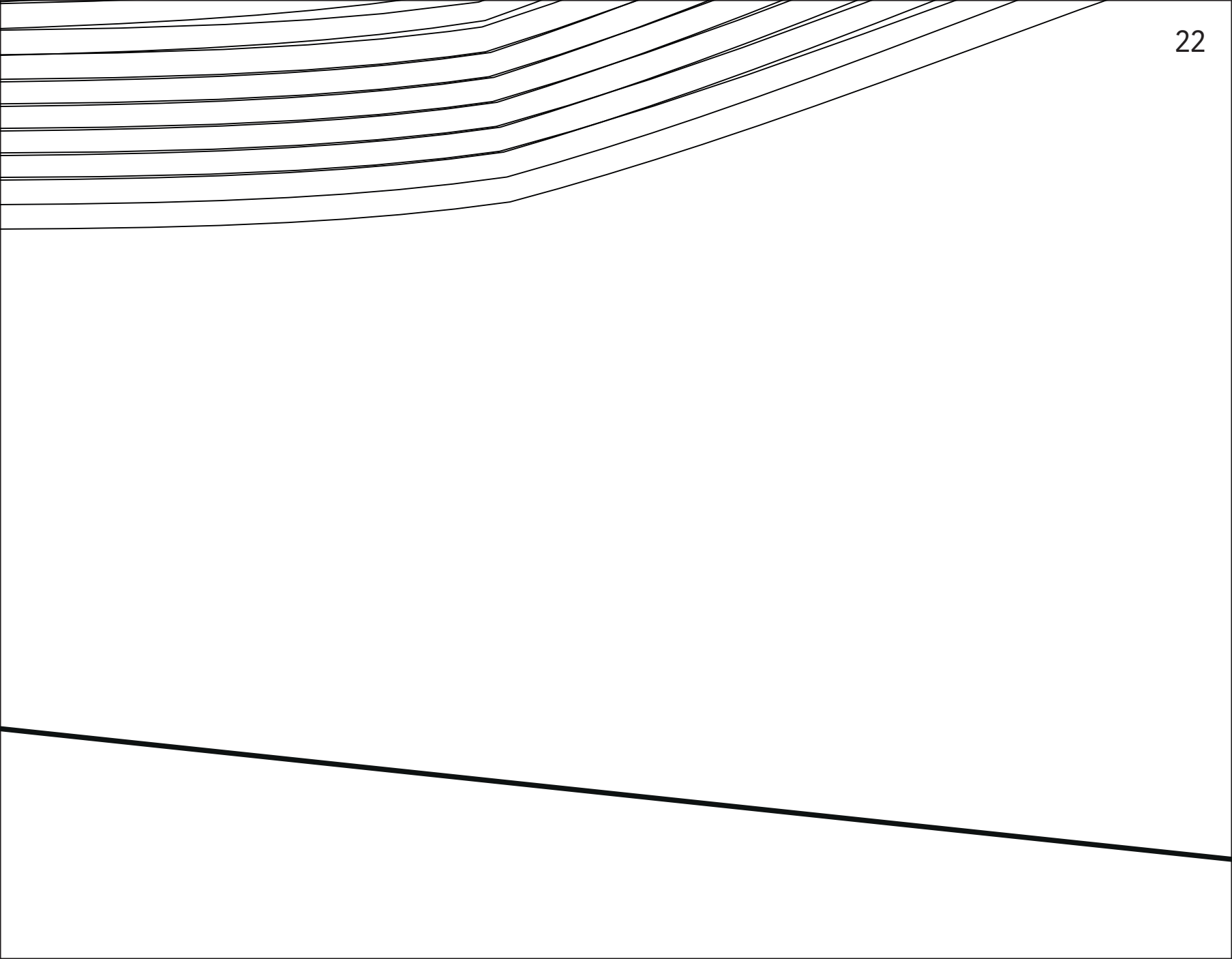

A

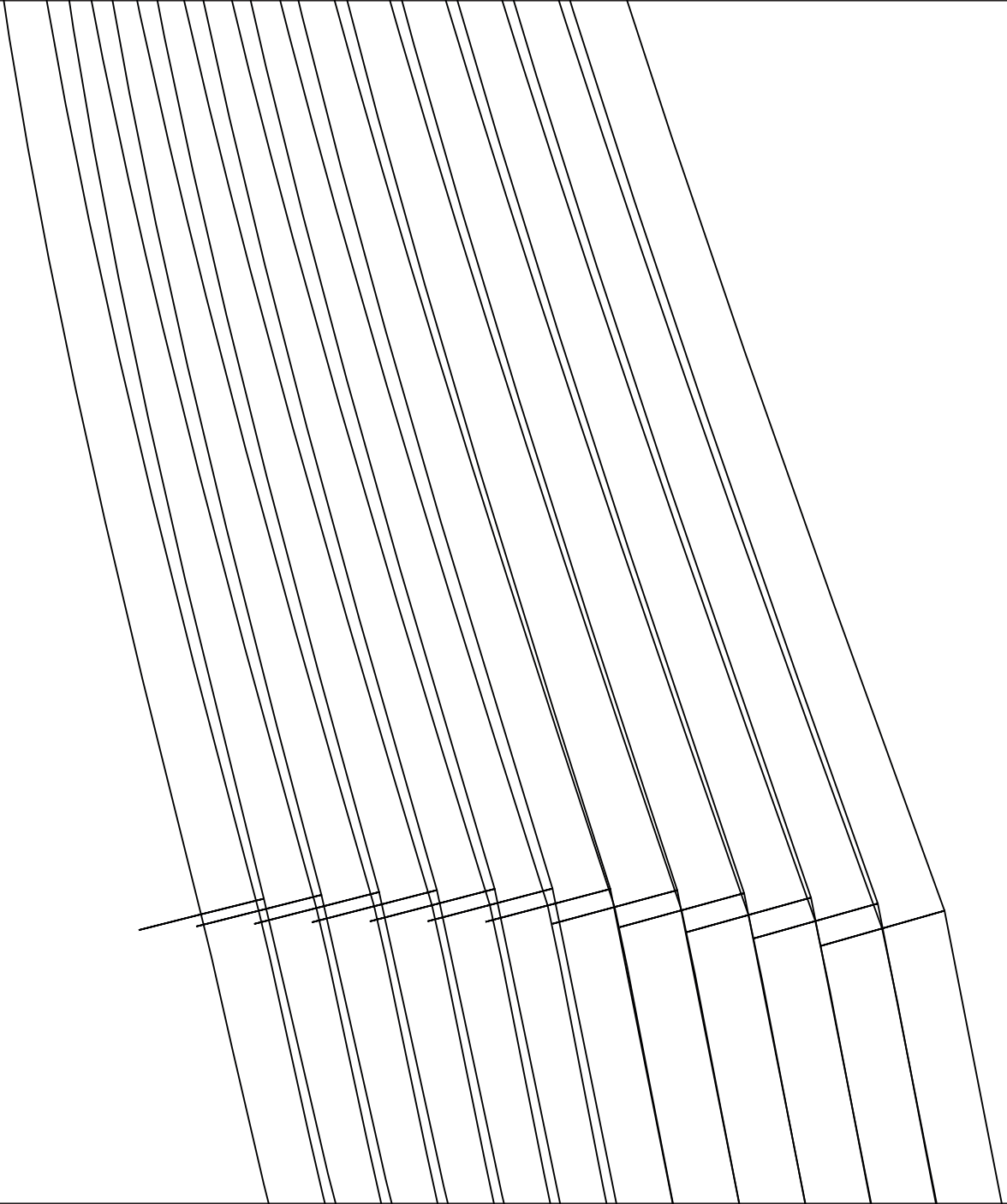



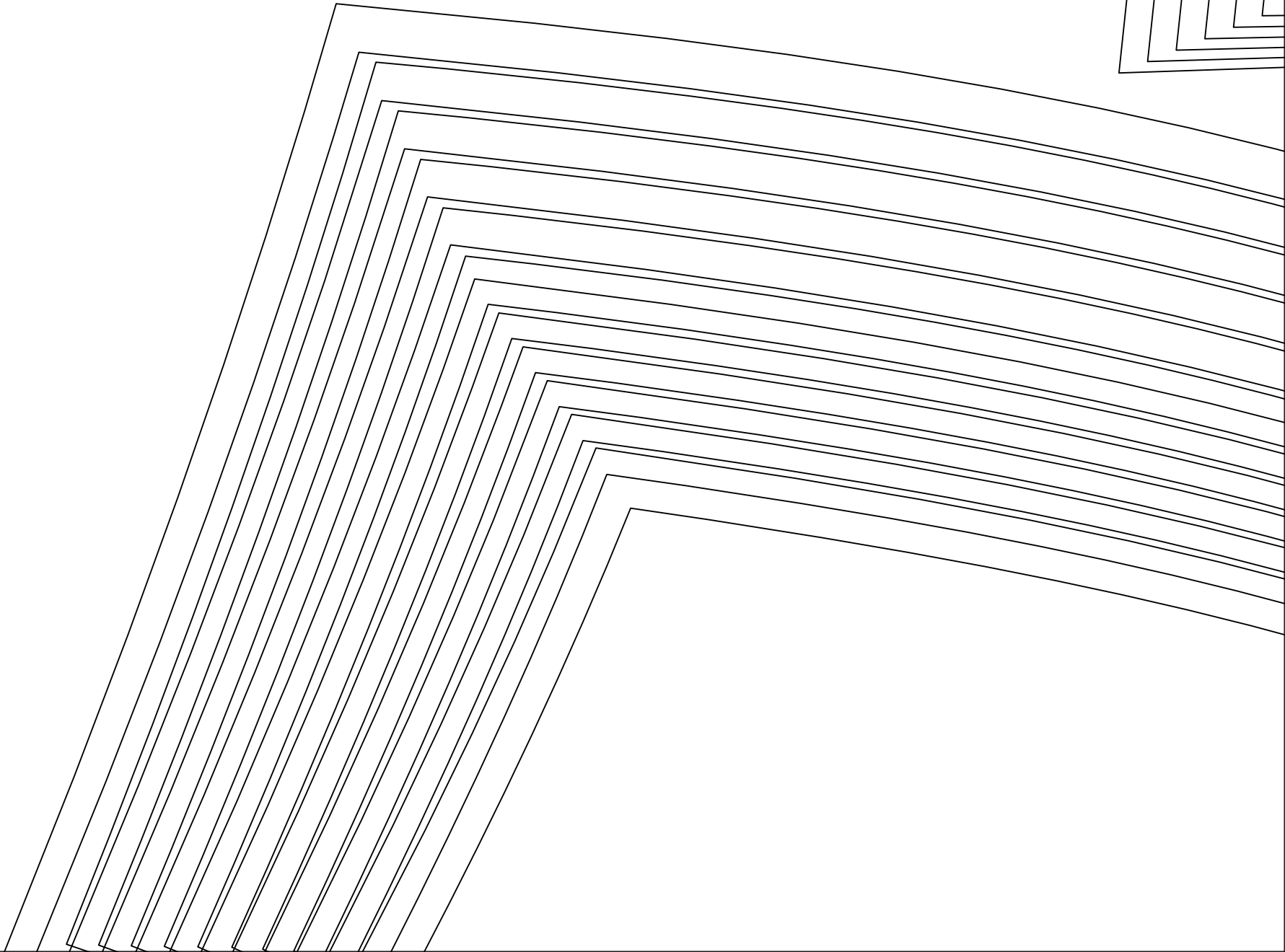



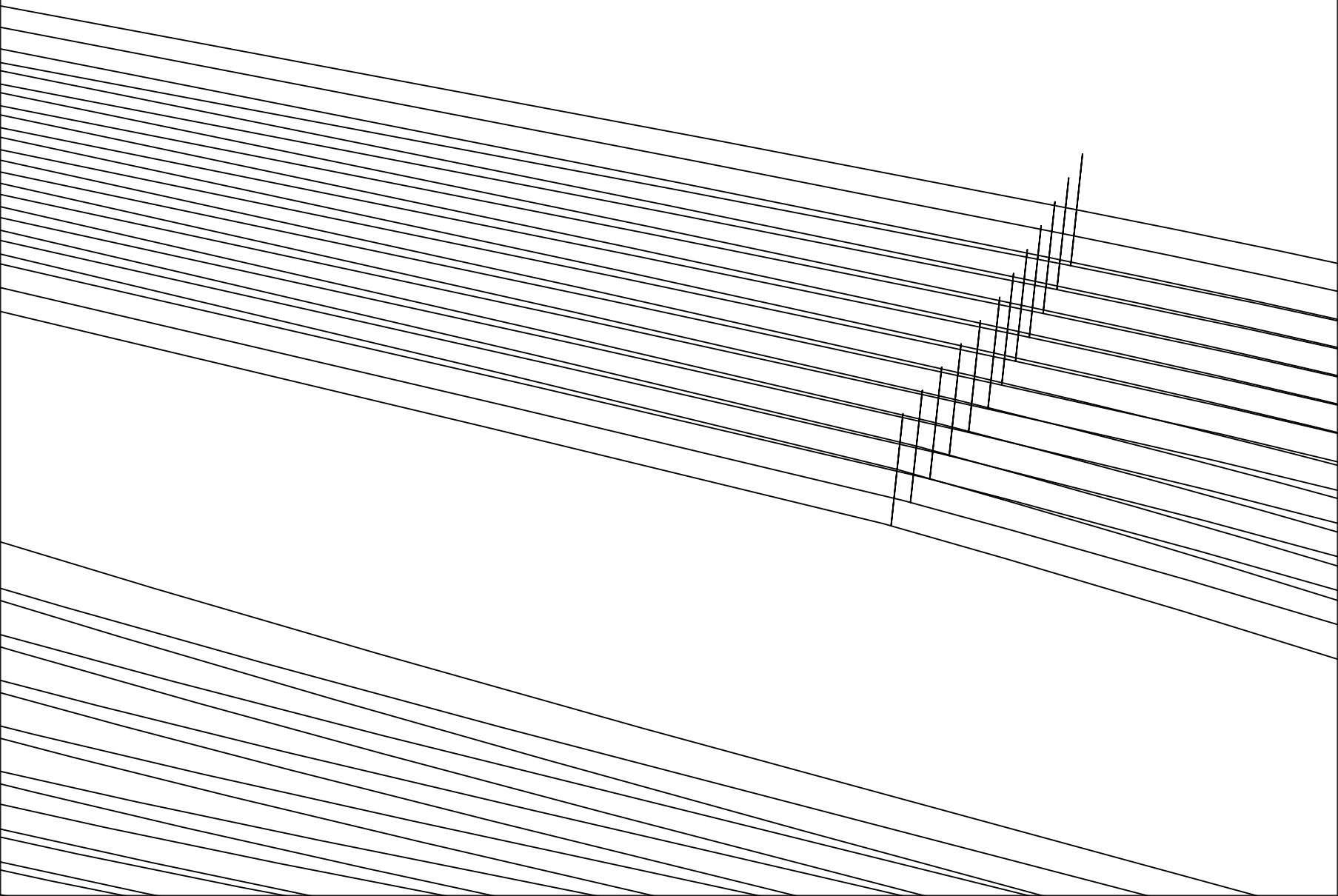

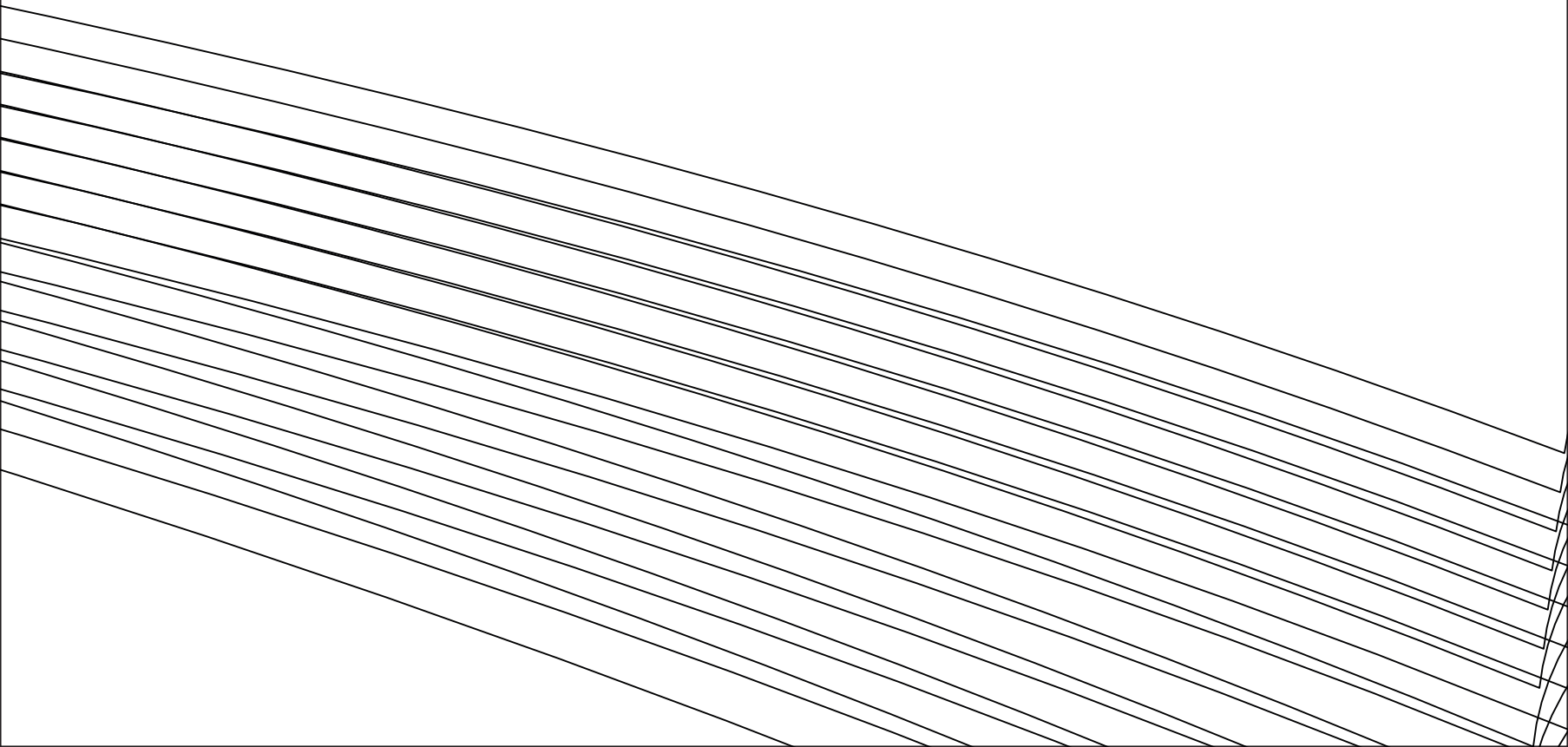



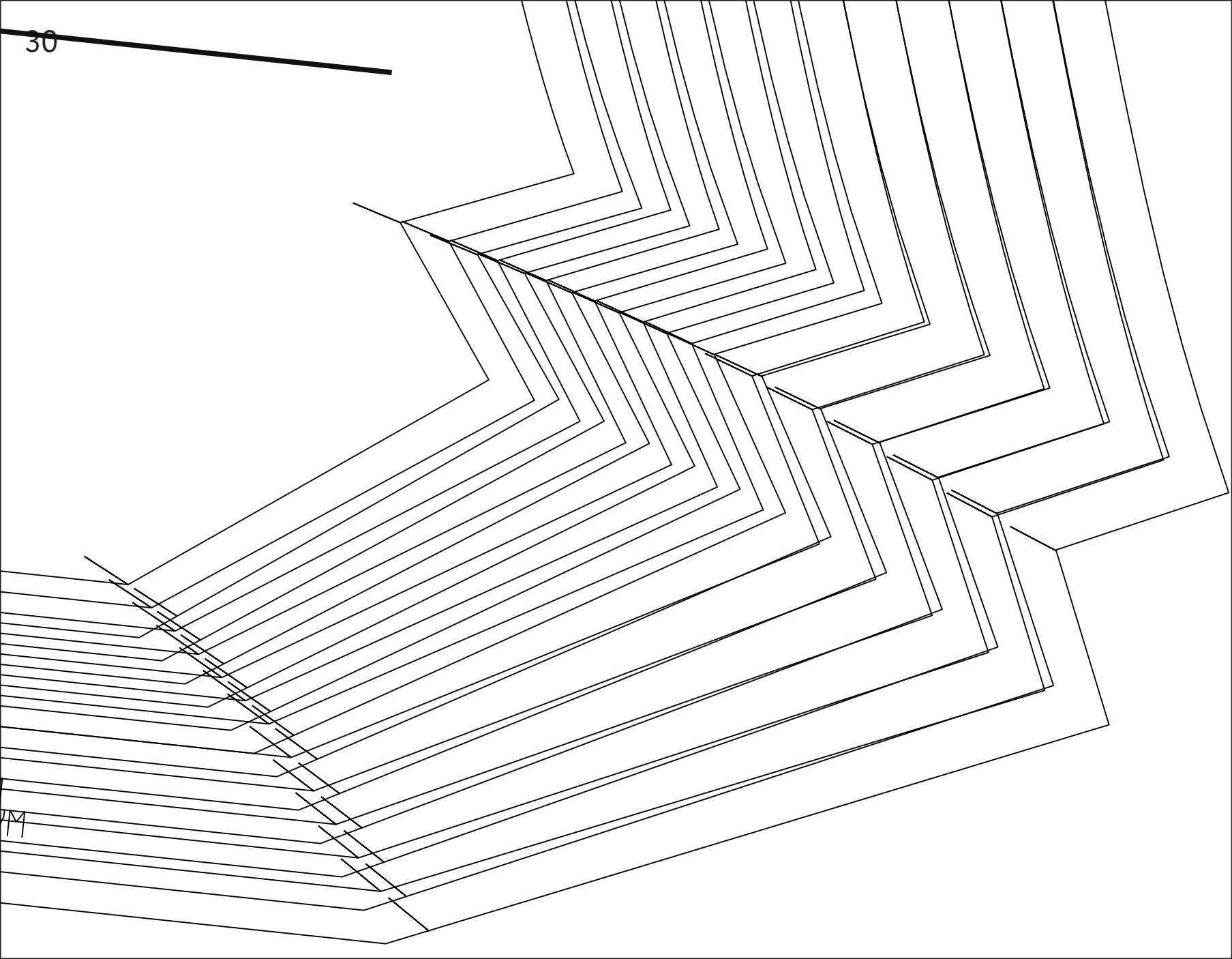

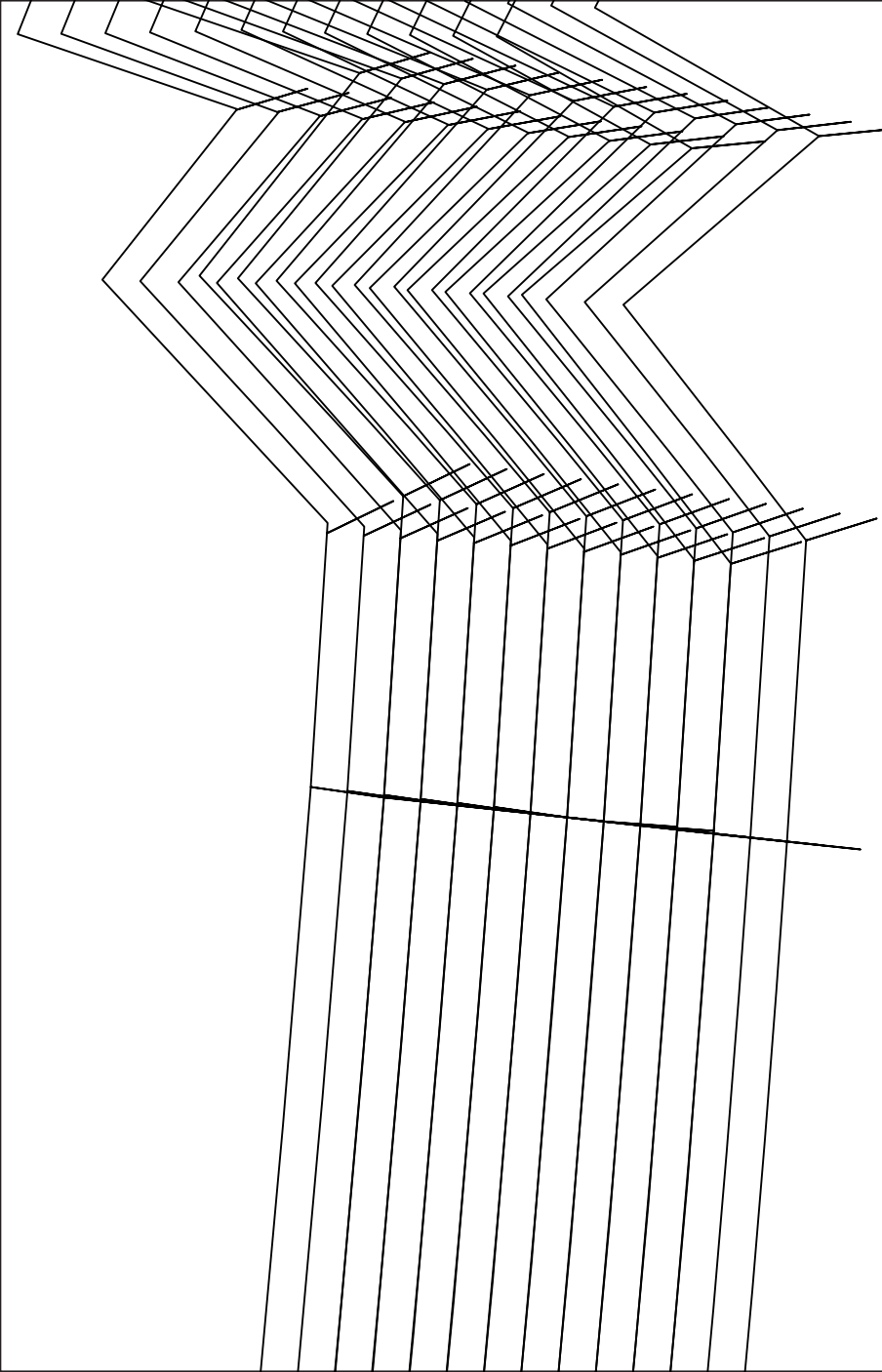

**B**



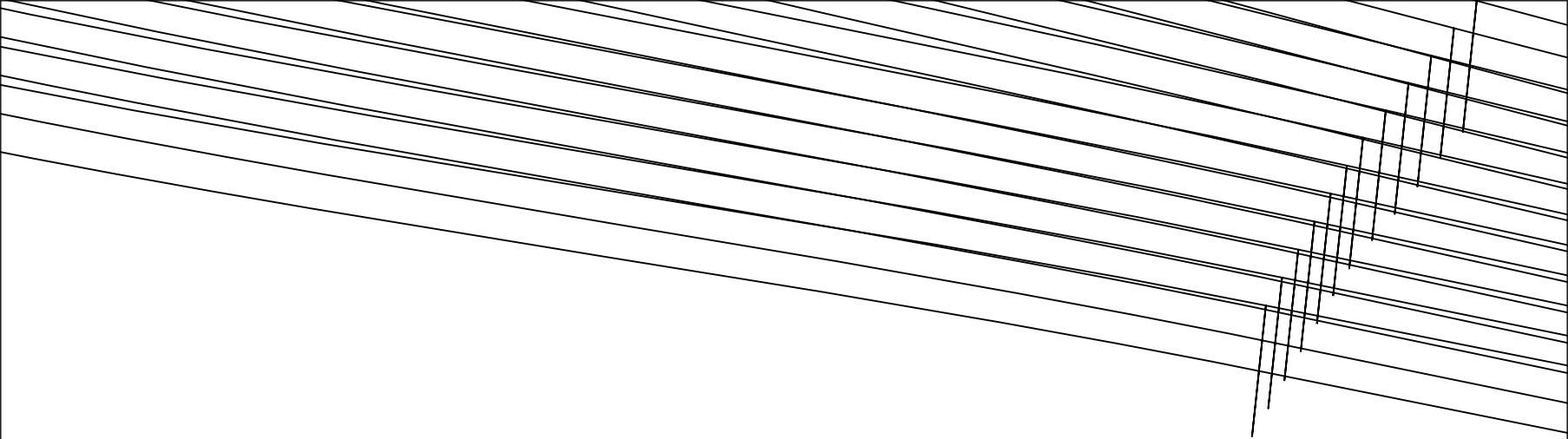

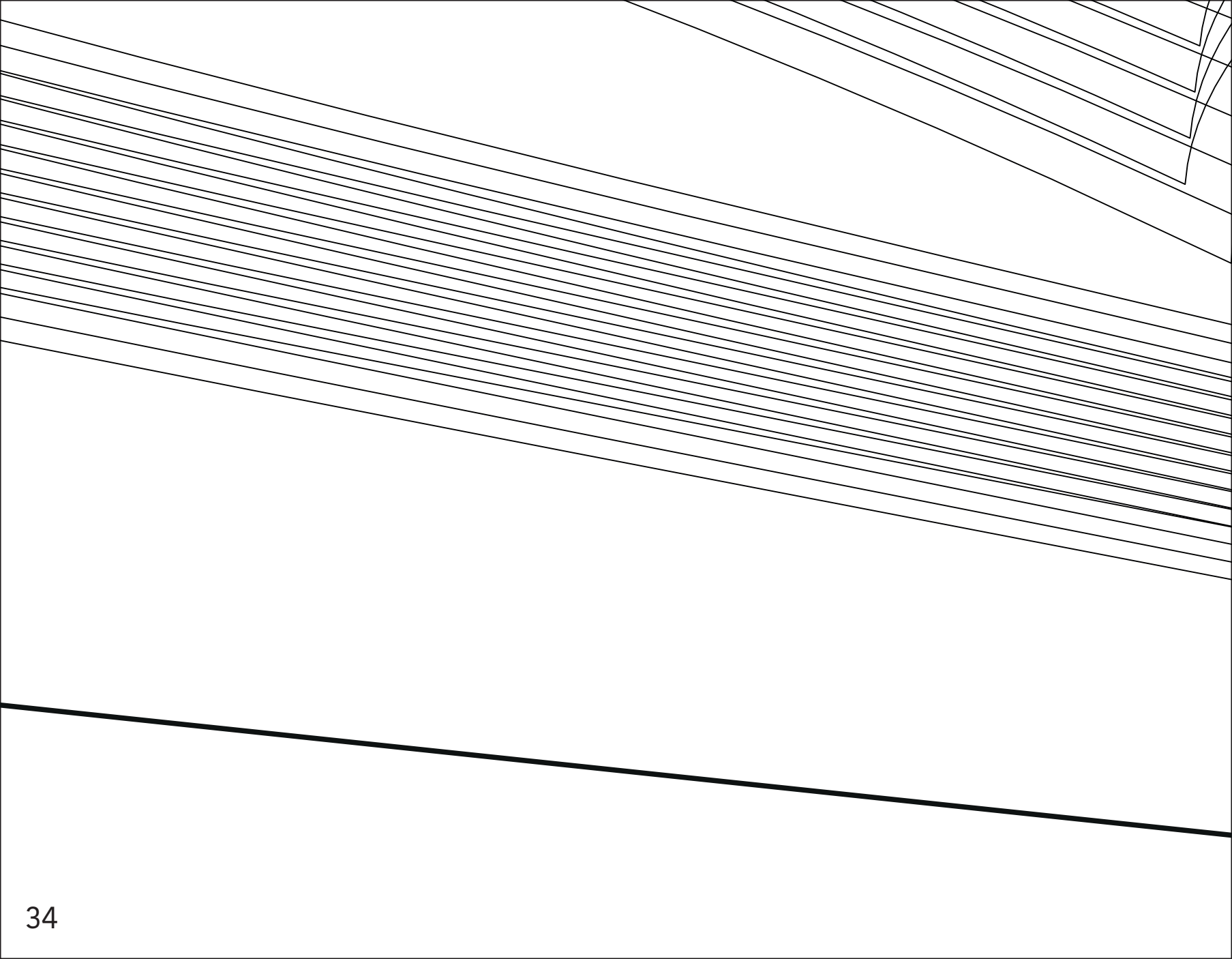

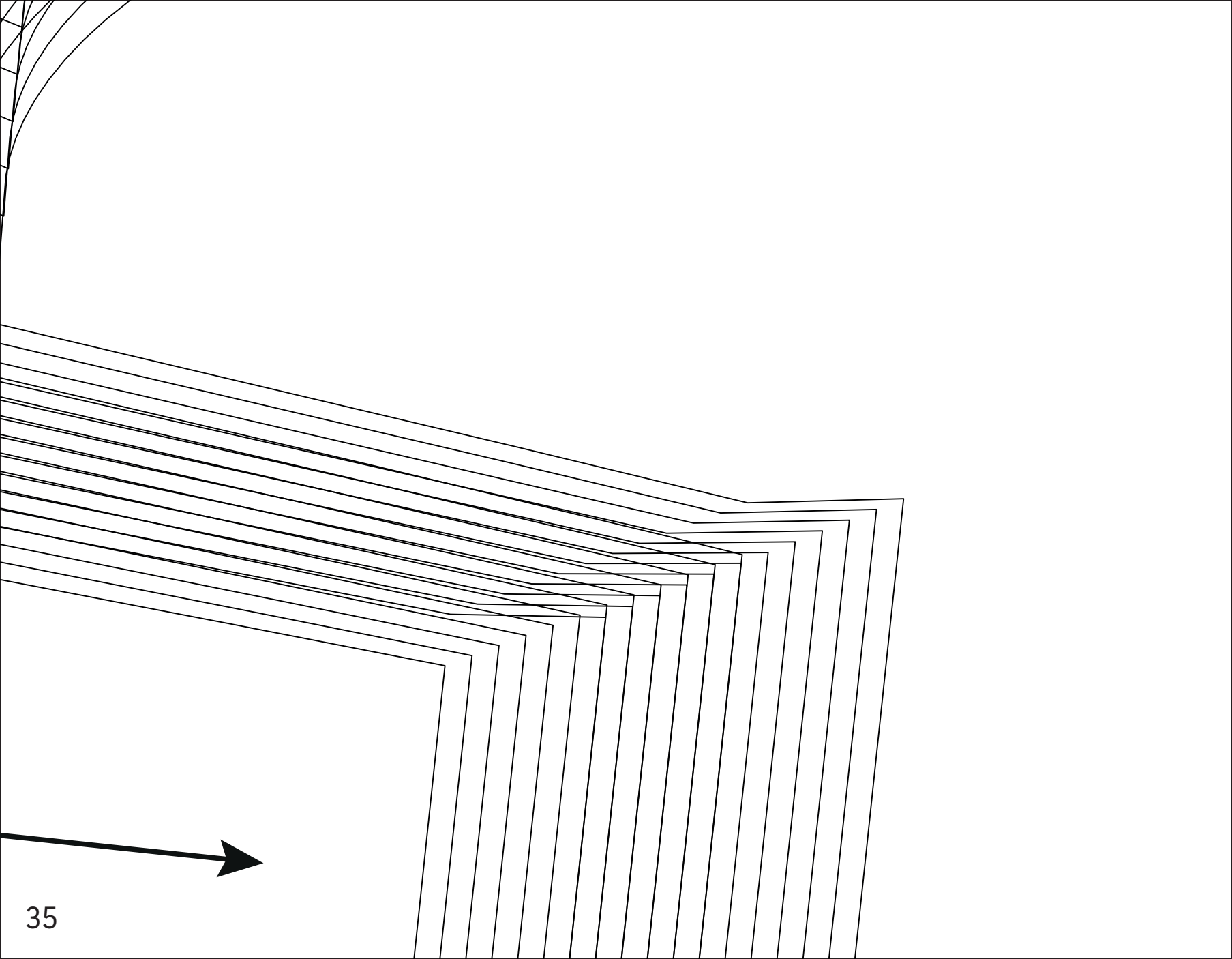

35





