

Patroonschema / Schéma du Patron / Pattern Diagram /
Übersichtsplan zum Zusammenkleben

Stian

Hemd / Chemise / Shirt / Hemd

Patroondelen / Pièces du patron / Pattern pieces / Schnittteile:

- A** voorpand / devant / front panel /
Vorderteil
- B** rugpand / dos / back panel /
Rückenteil
- C** mouw / manche / sleeve / Ärmel
- D** beleg VP / parementure DV /
facing FP / Besatz VT
- E** beleg RP / parementure DS /
facing BP / Besatz RT

1	2	3	4	5	6
7	8	9	10	11	12
13	14	15	16	17	18
19	20	21	22	23	24

Controlevierkant / Carré de controle
/ Test square / Kontrollquadrat

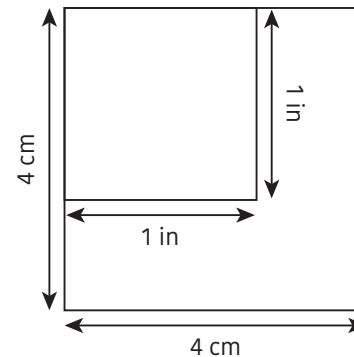

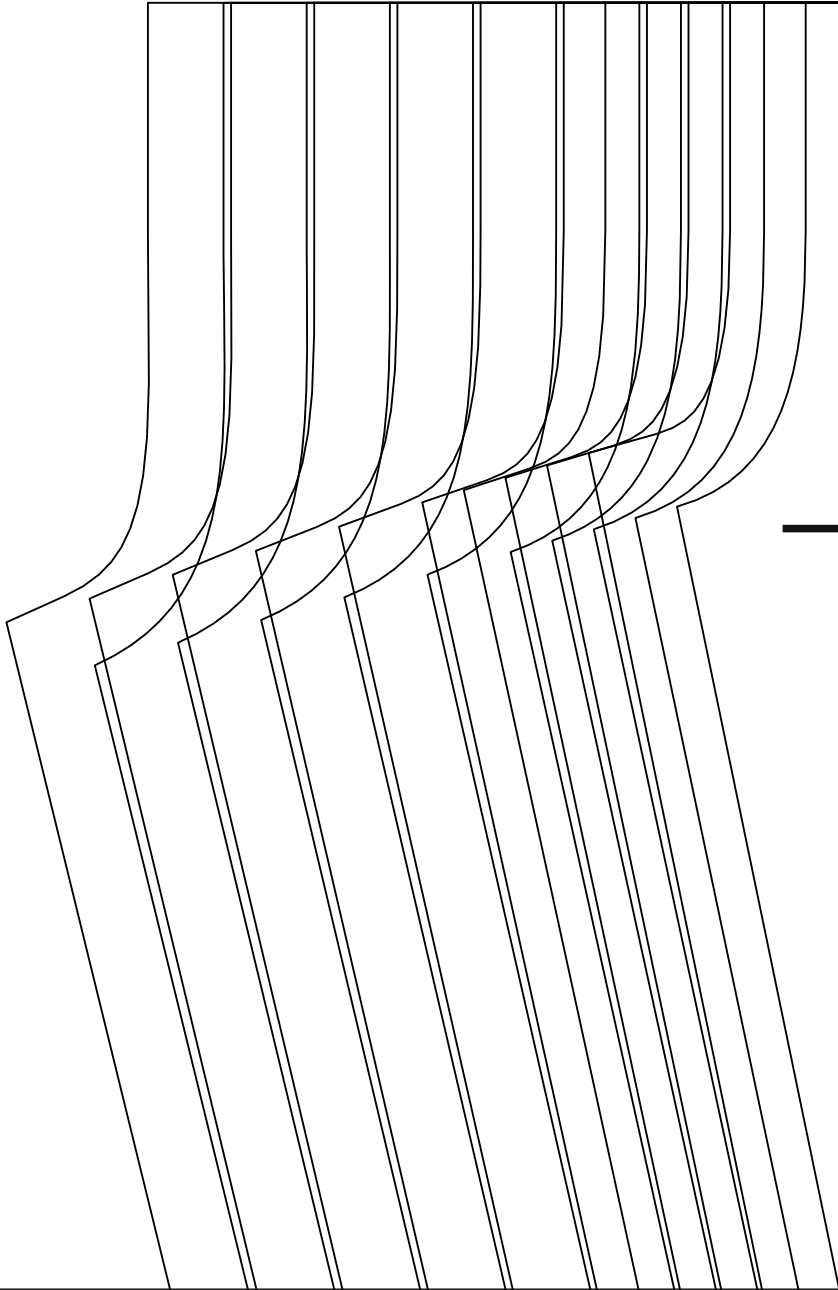

MR/MDS/CB/RM

B

--	--	--	--	--	--	--	--	--	--	--	--	--	--	--	--	--	--	--	--



--	--	--	--	--

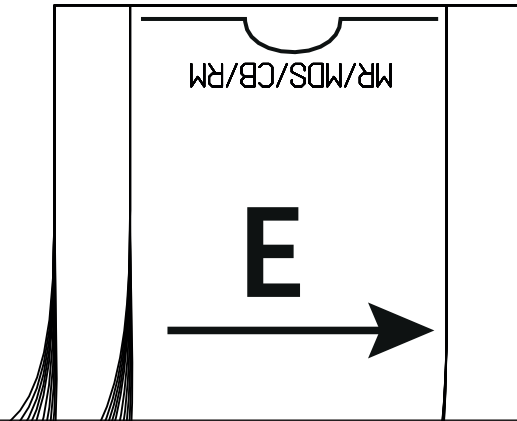
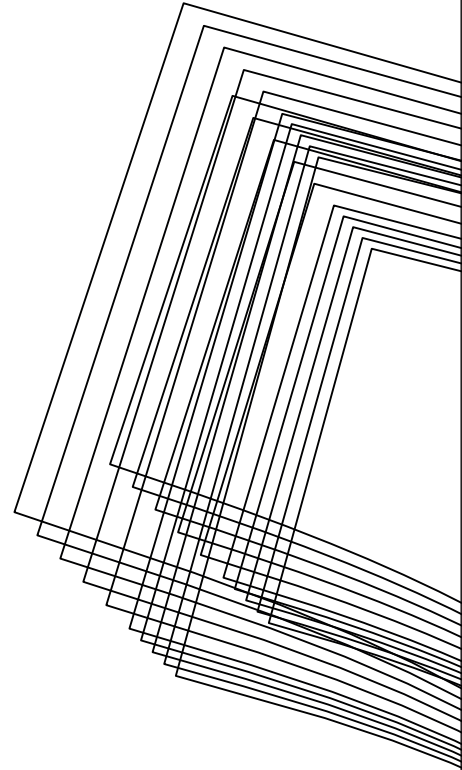

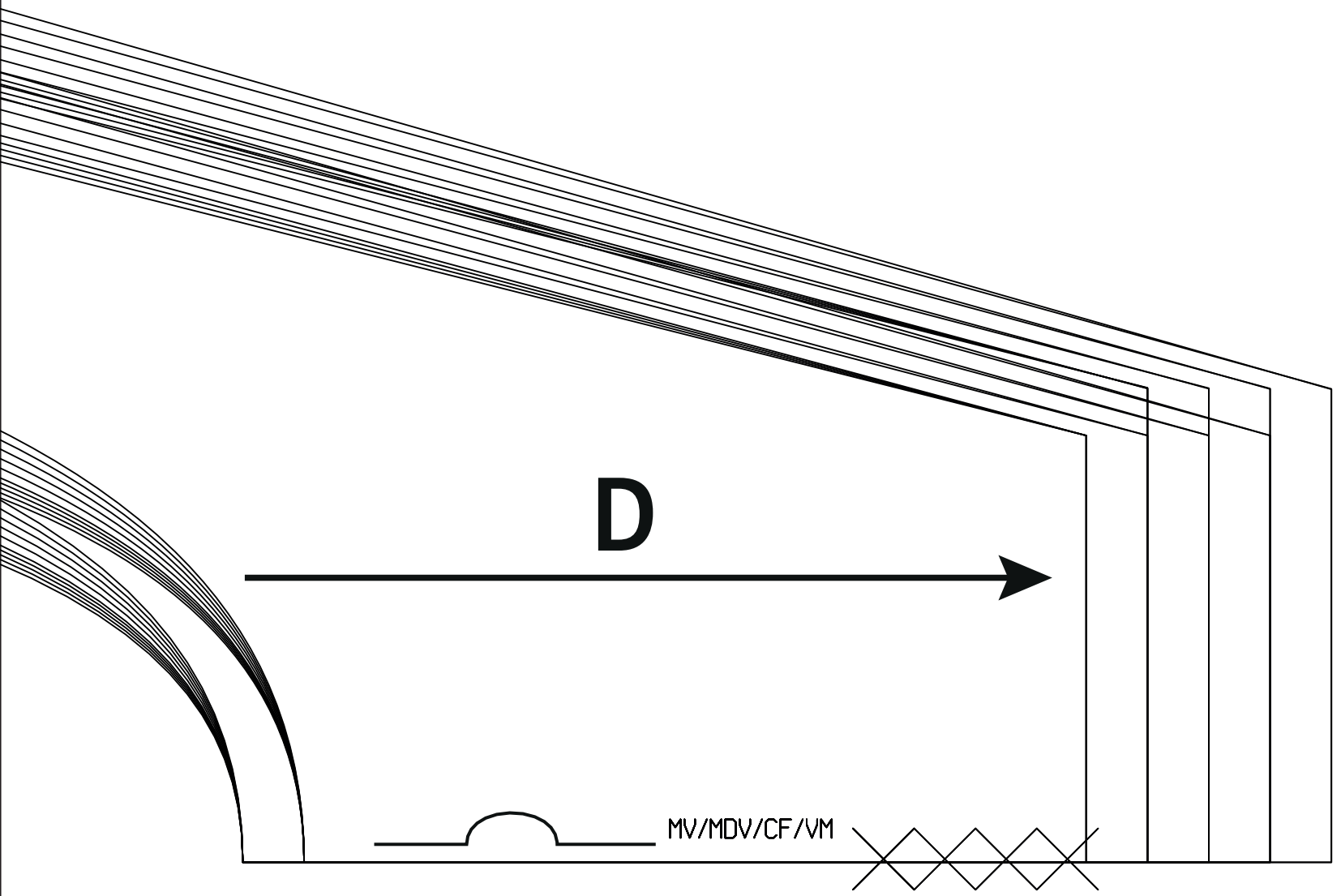

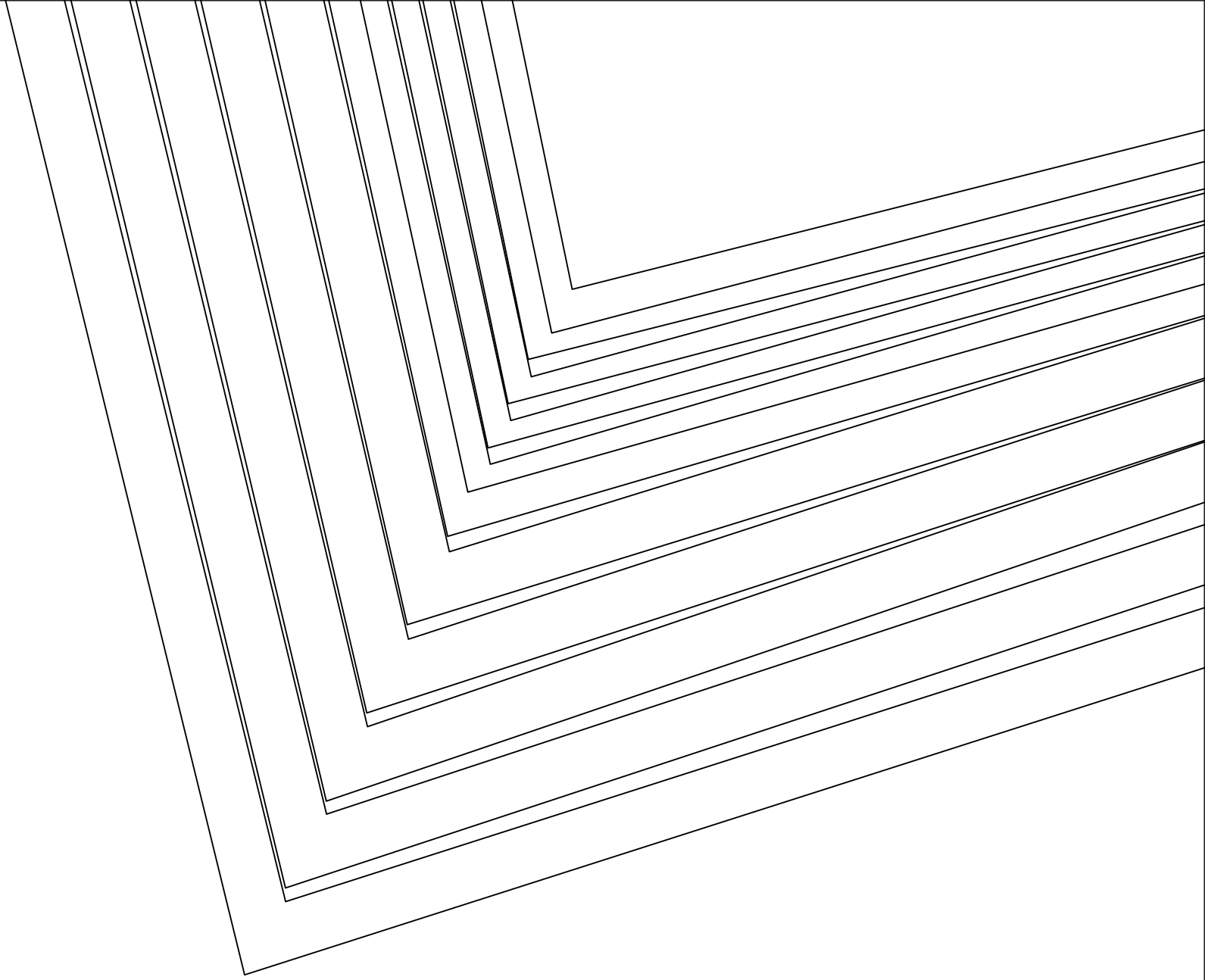

9

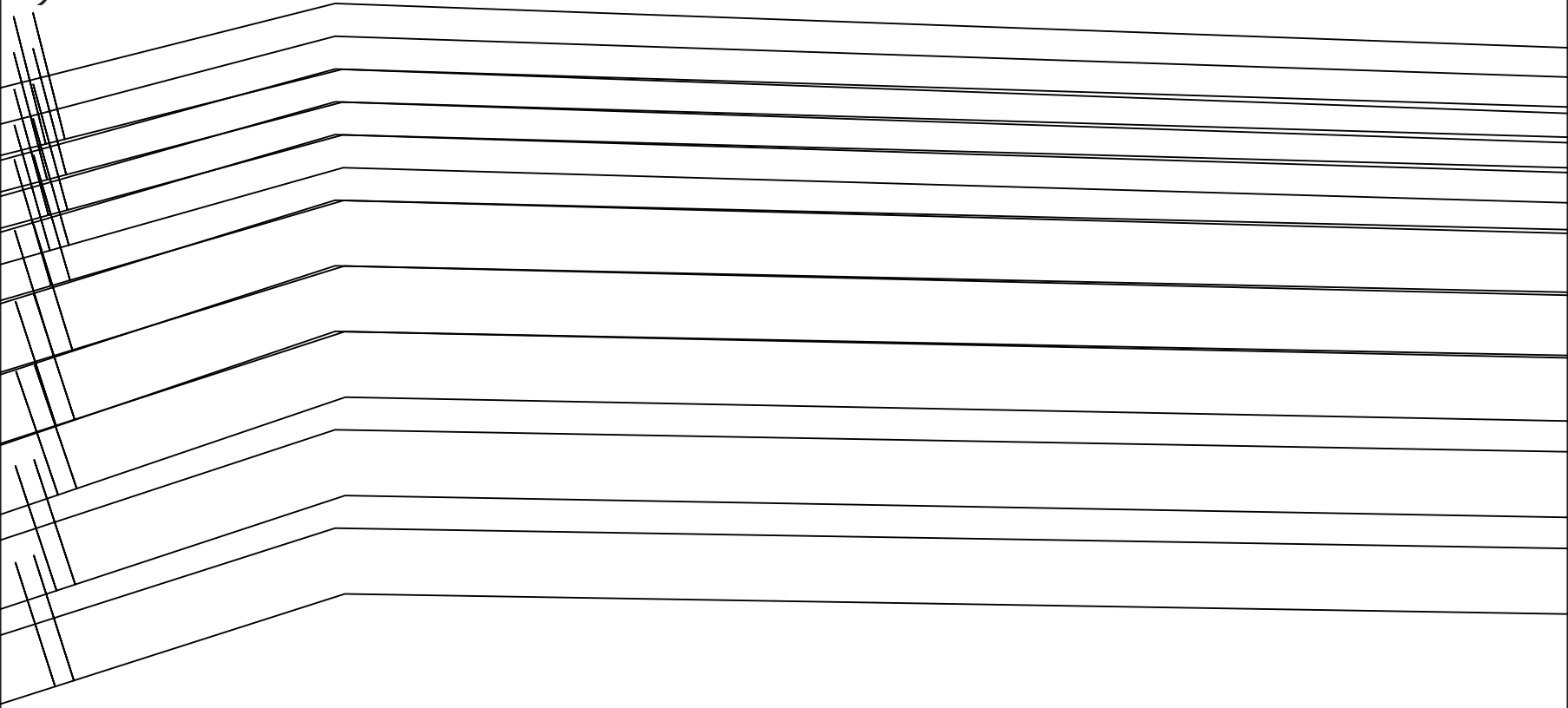

10

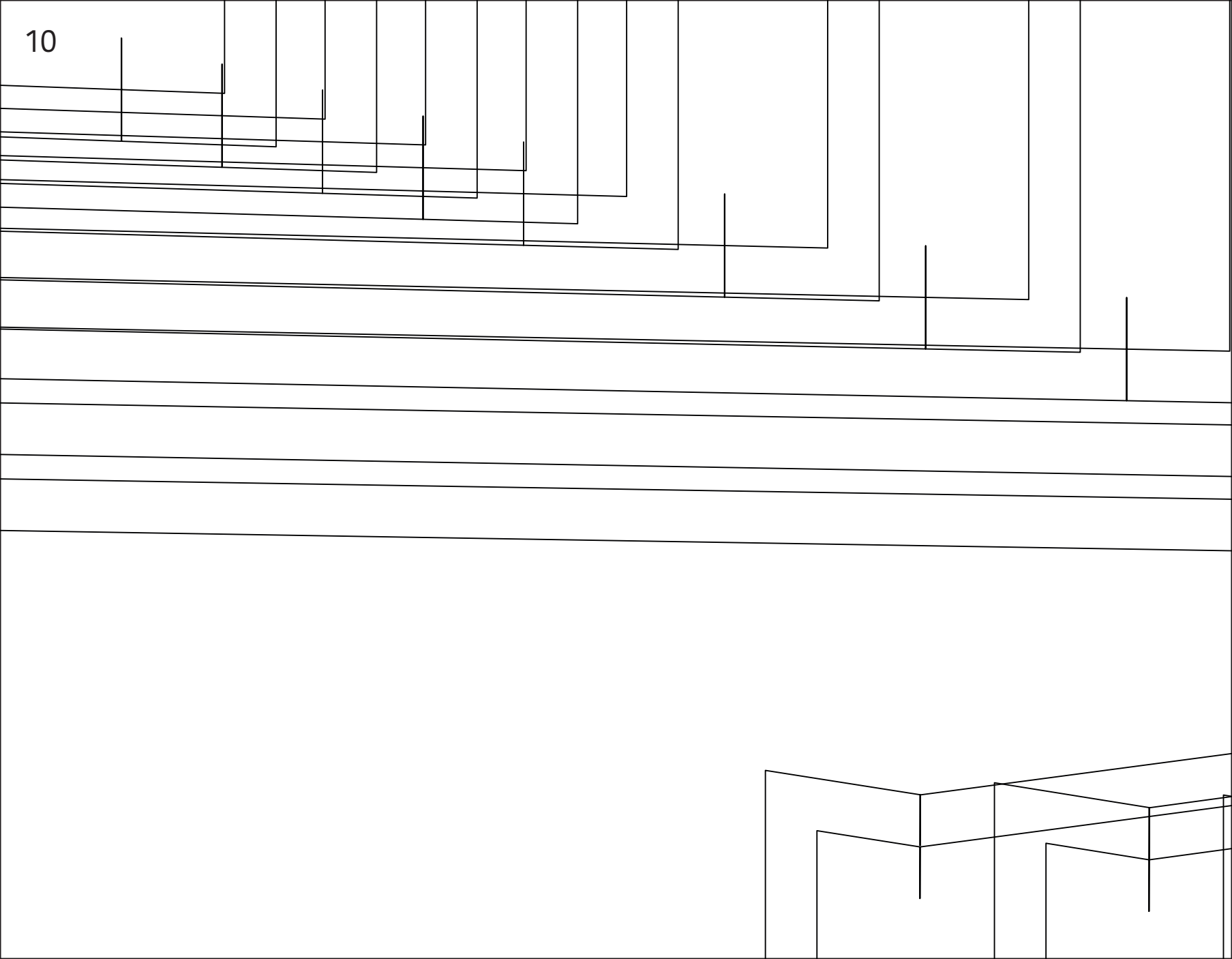

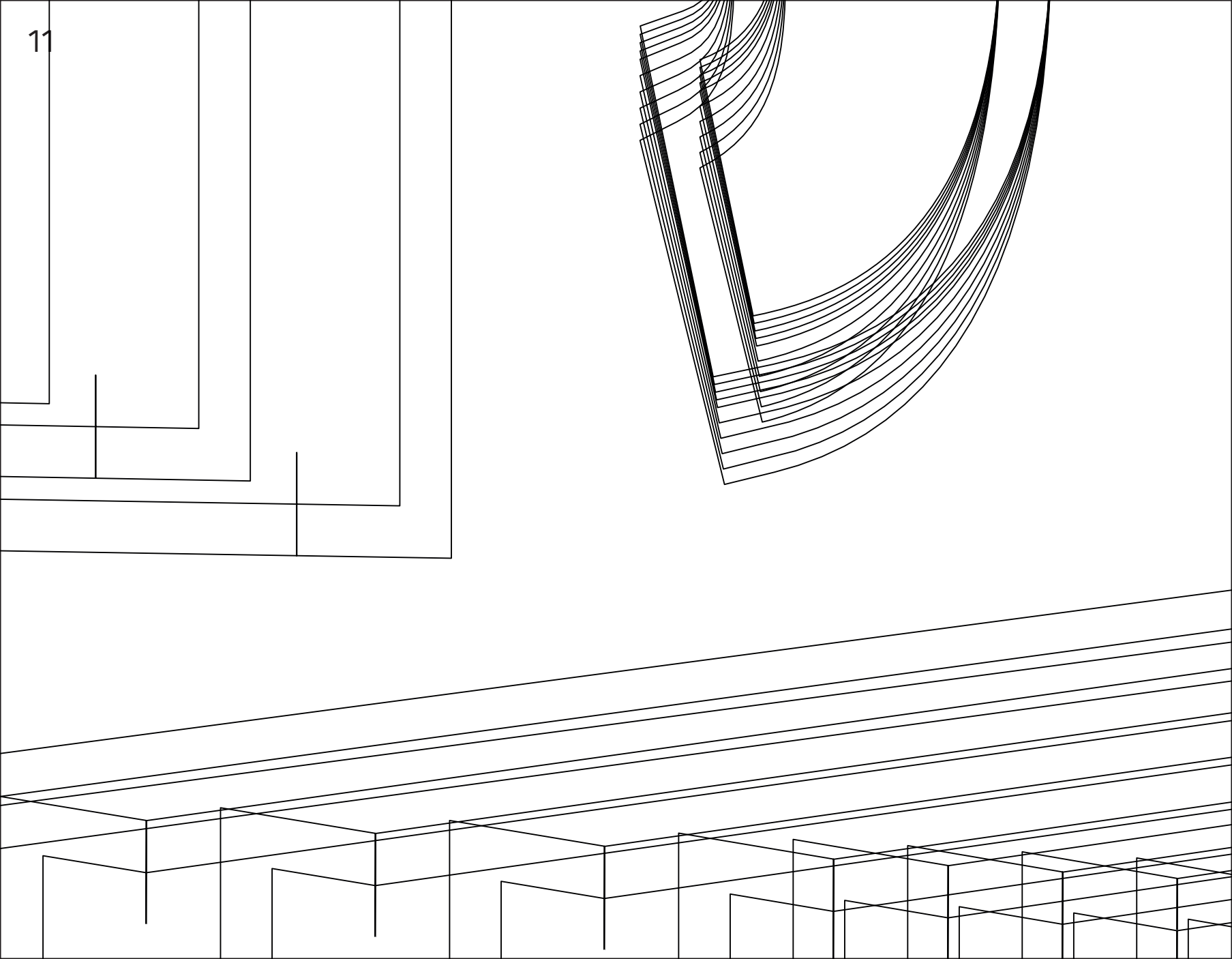

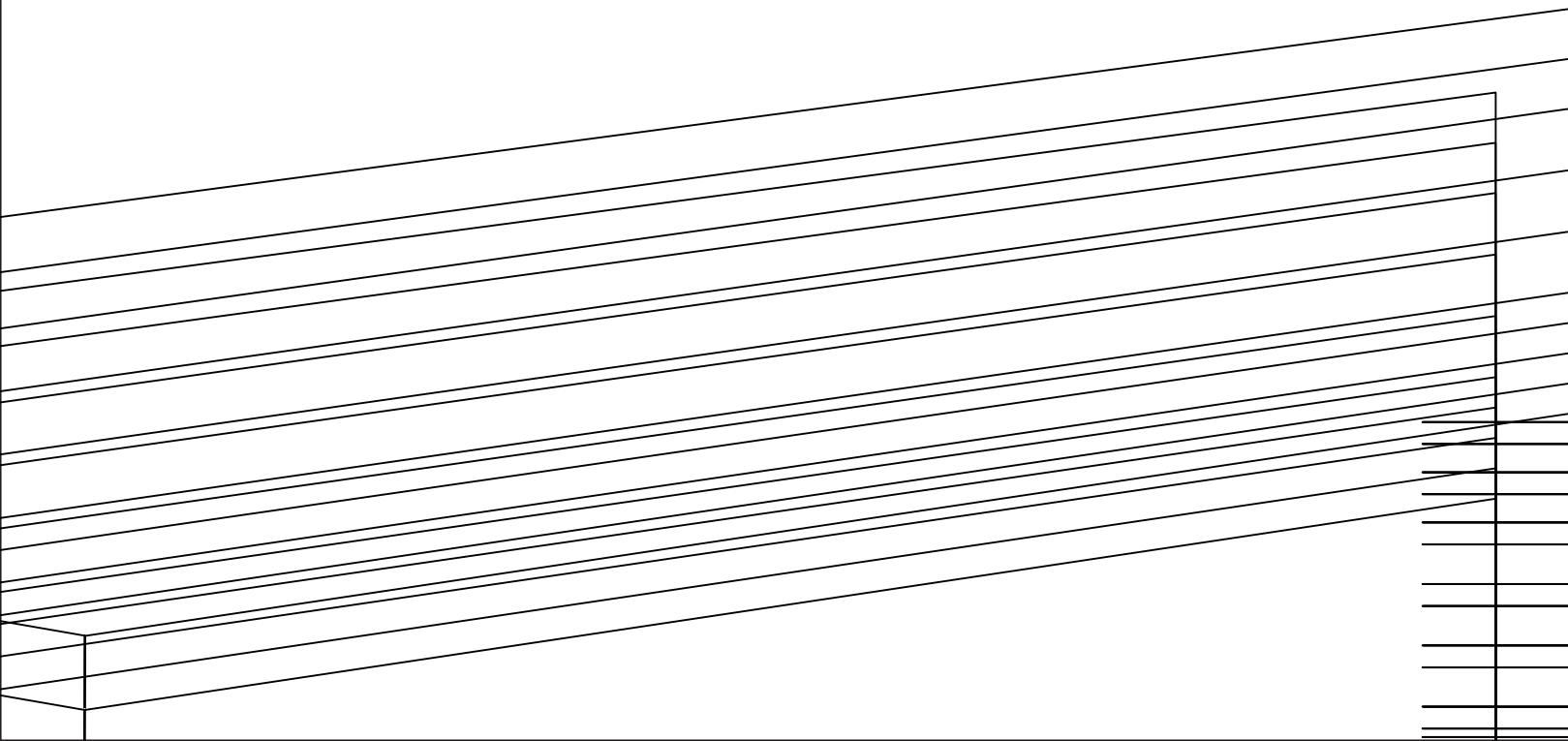

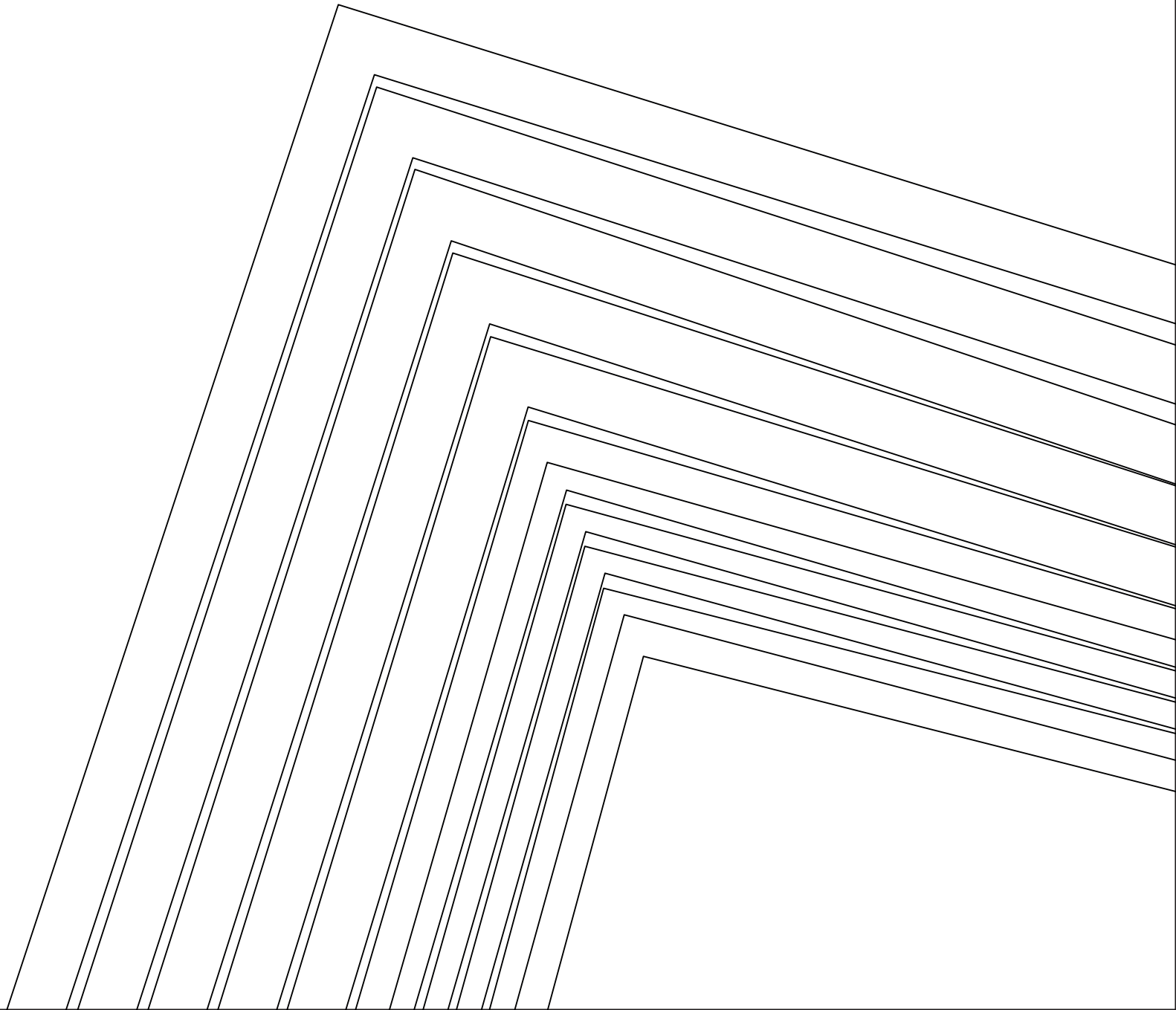

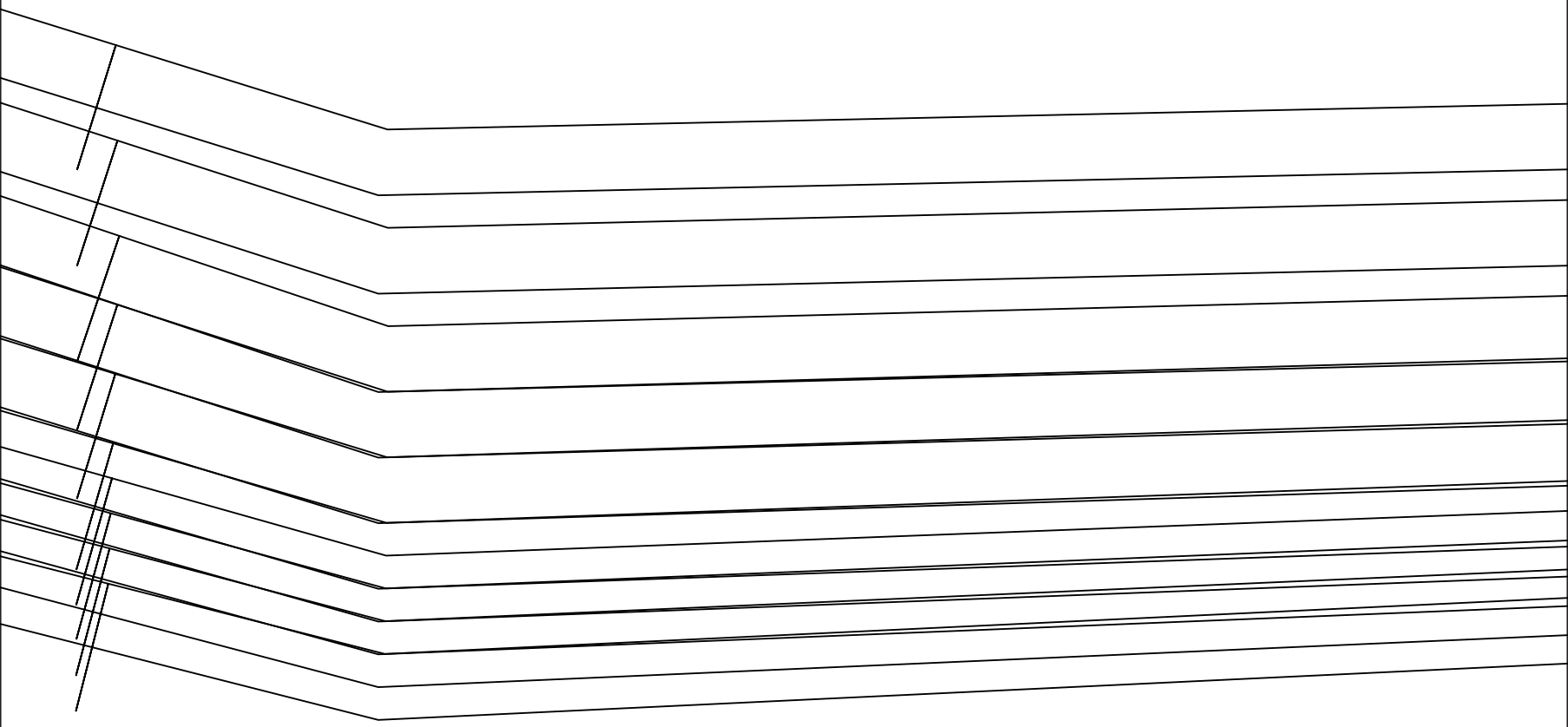

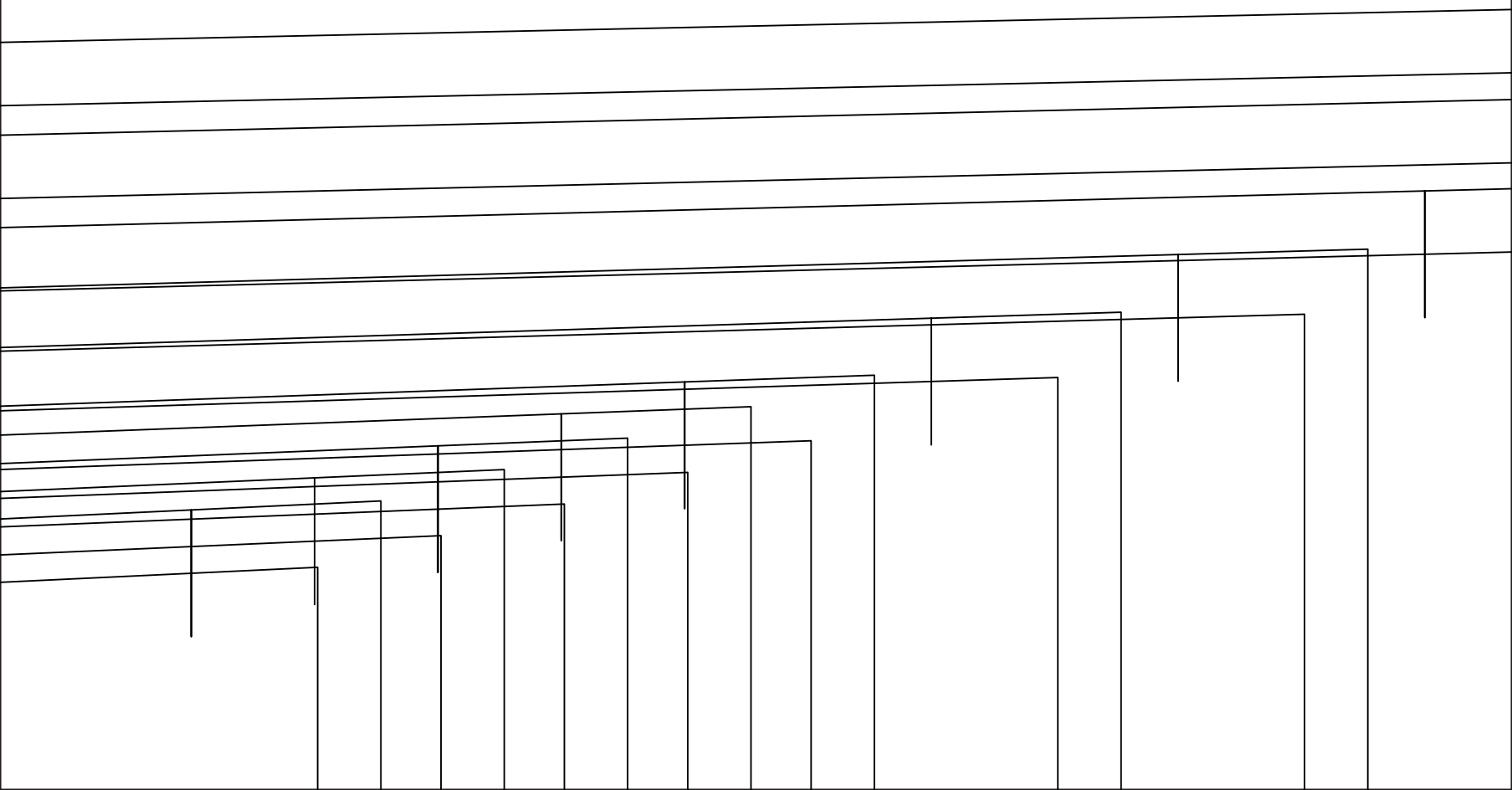

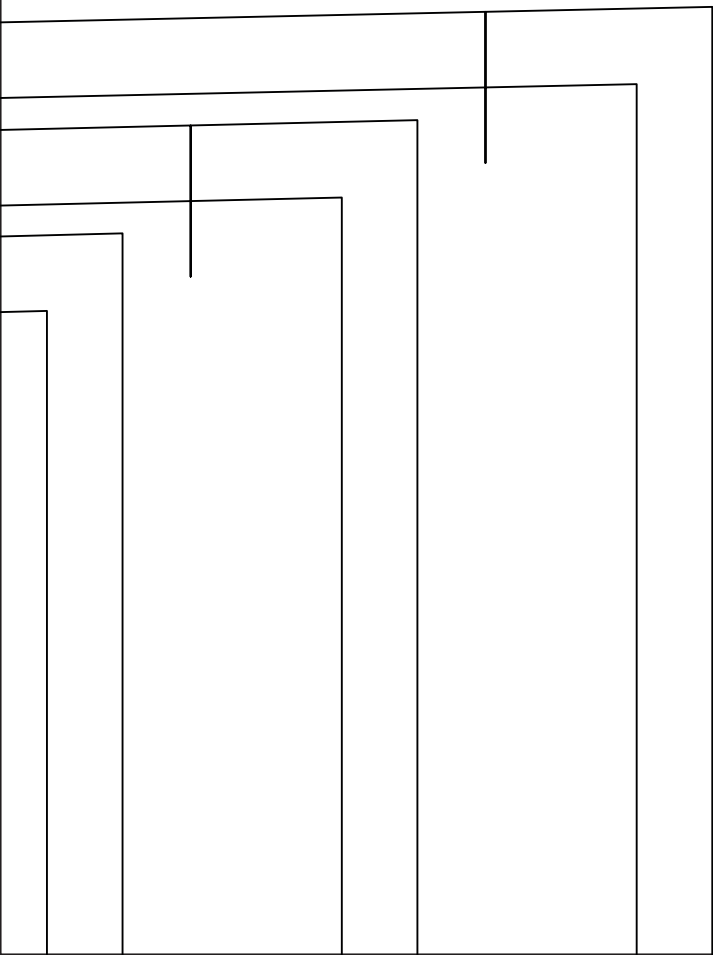

--	--	--	--	--

18

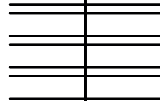

3



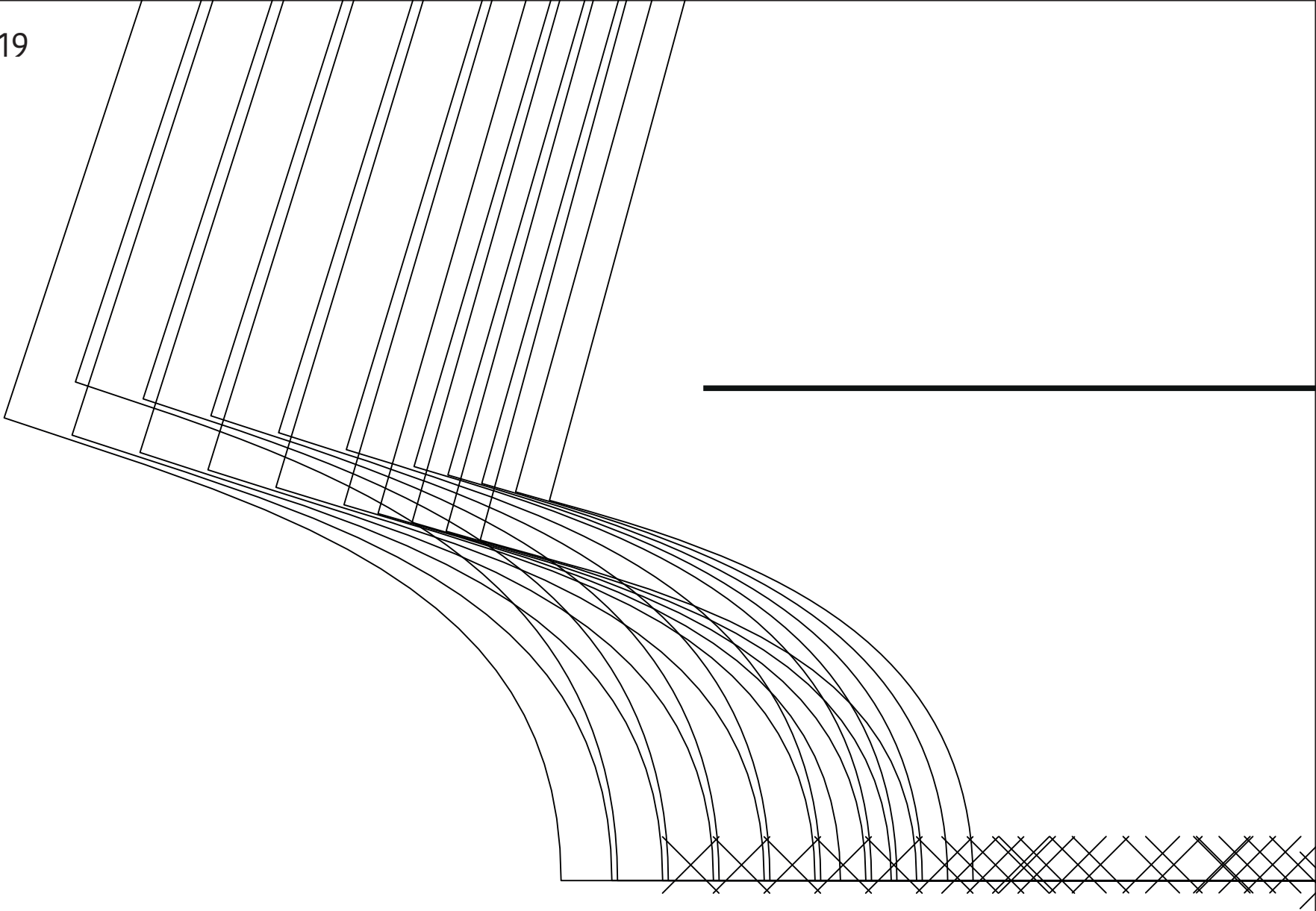

A

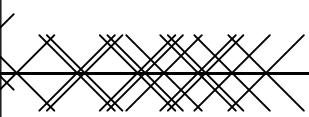

MV/MDV/CF/VM

