

Patroonschema / Schéma du Patron / Pattern Diagram /
Übersichtsplan zum Zusammenkleben

Fanny

Broek / Pantalon / Trousers / Hose

- A** voorpand / devant / front panel /
Vorderteil
- B** rugpand / dos / back panel /
Rückenteil
- C** zak / poche / pocket / Tasche
- D** beleg VP / parementure DV /
facing FP / Besatz VT
- E** riemlusjes / passants / belt loops /
Gürtelschlaufen
- F** bies / passepoil poche / trim / Paspel
- G** inkiijk / ouverture poche /
outer pocket / Tascheneingriff
- H** striklint / ceinture / ribbon /
Bindegürtel

1	2	3	4	5	6
7	8	9	10	11	12
13	14	15	16	17	18
X 19	20	21	22	23	24

Controlevierkant / Carré de controle
/ Test square / Kontrollquadrat

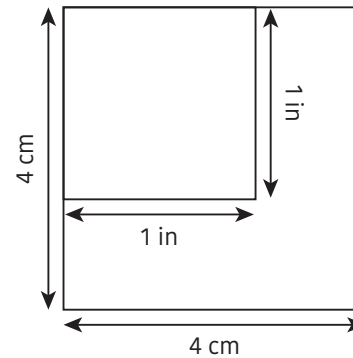

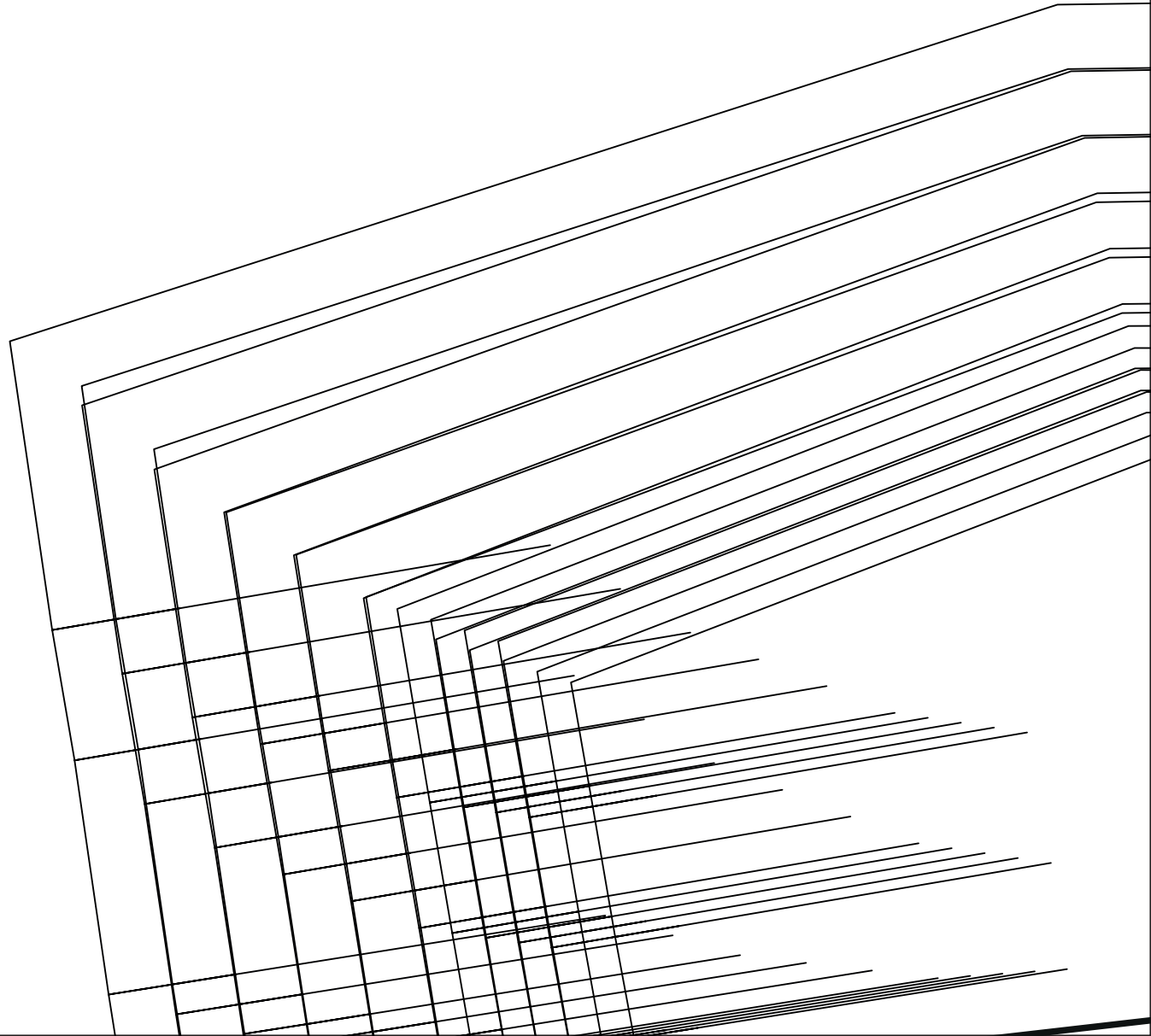

3

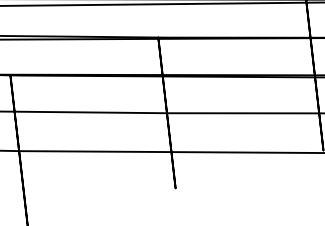
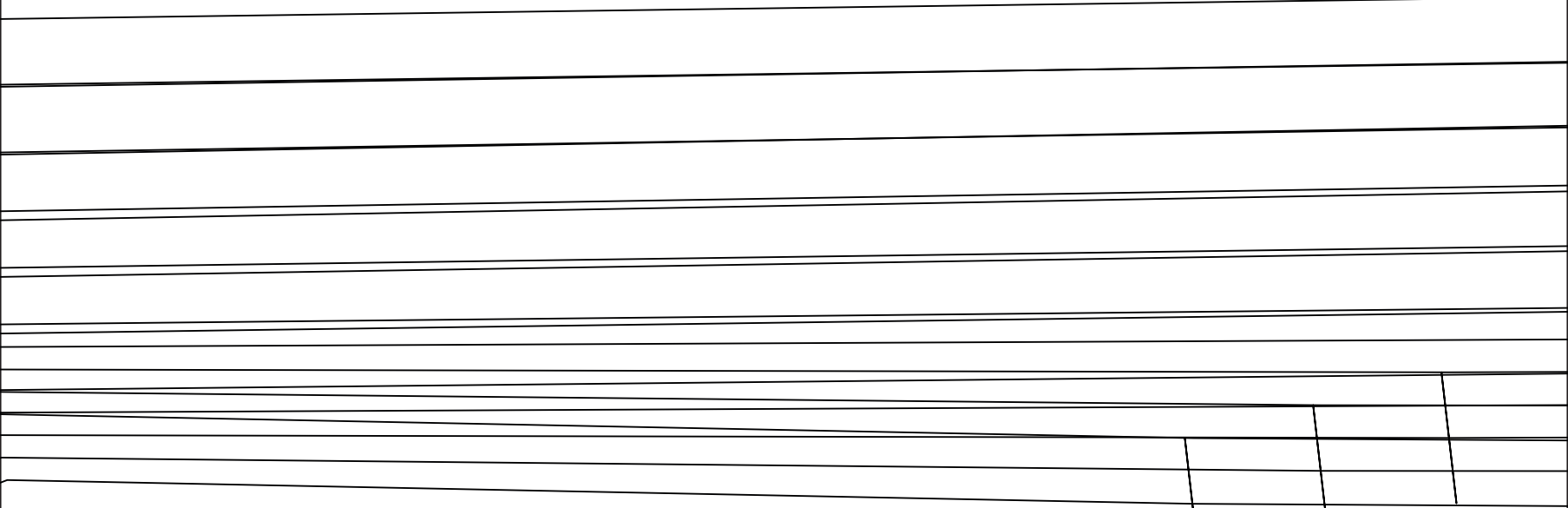

A

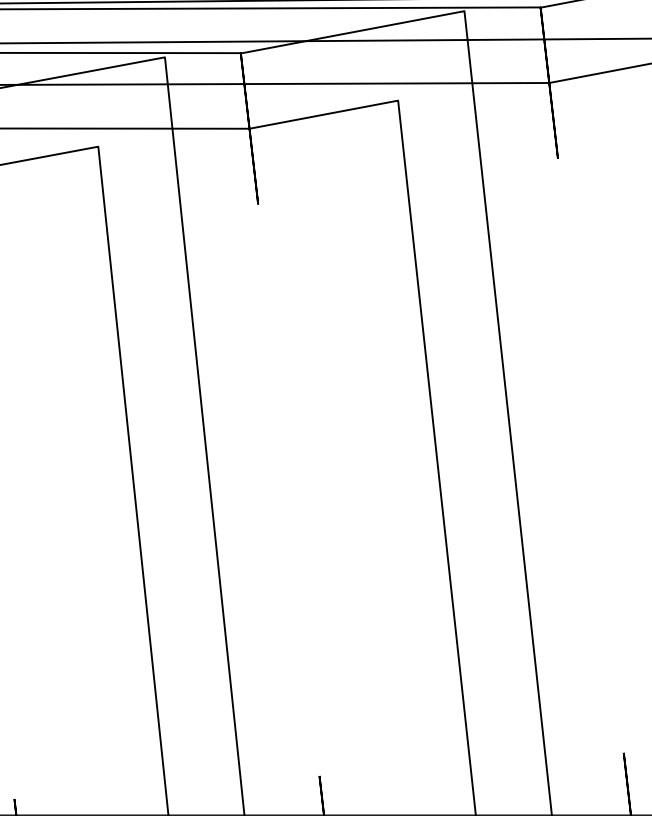
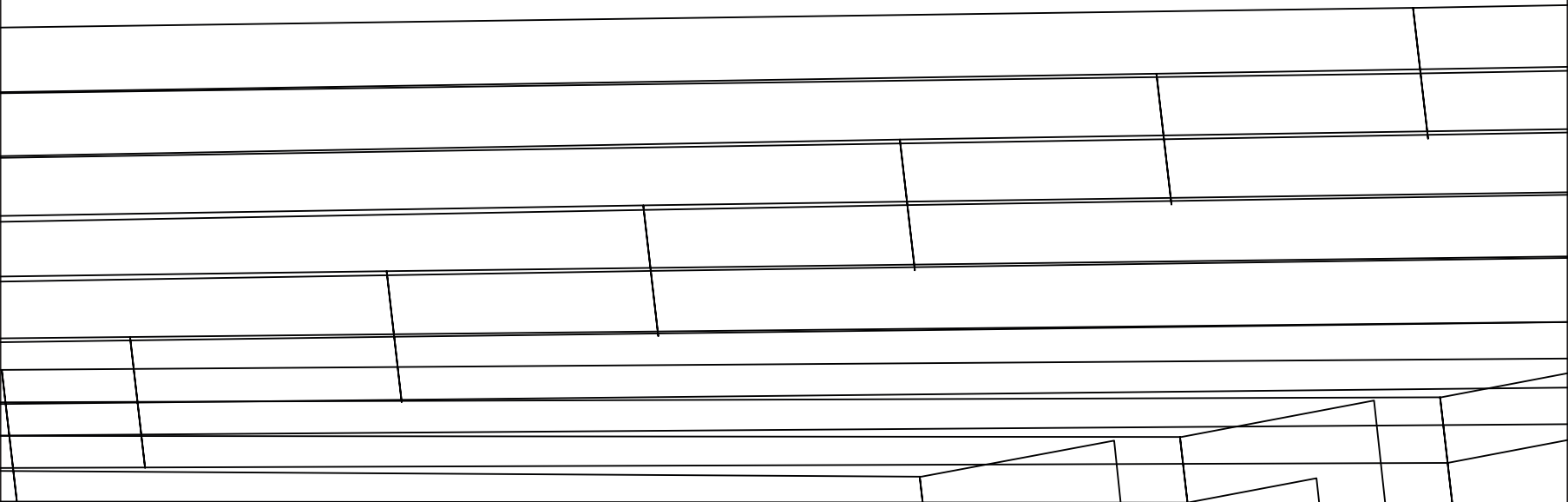

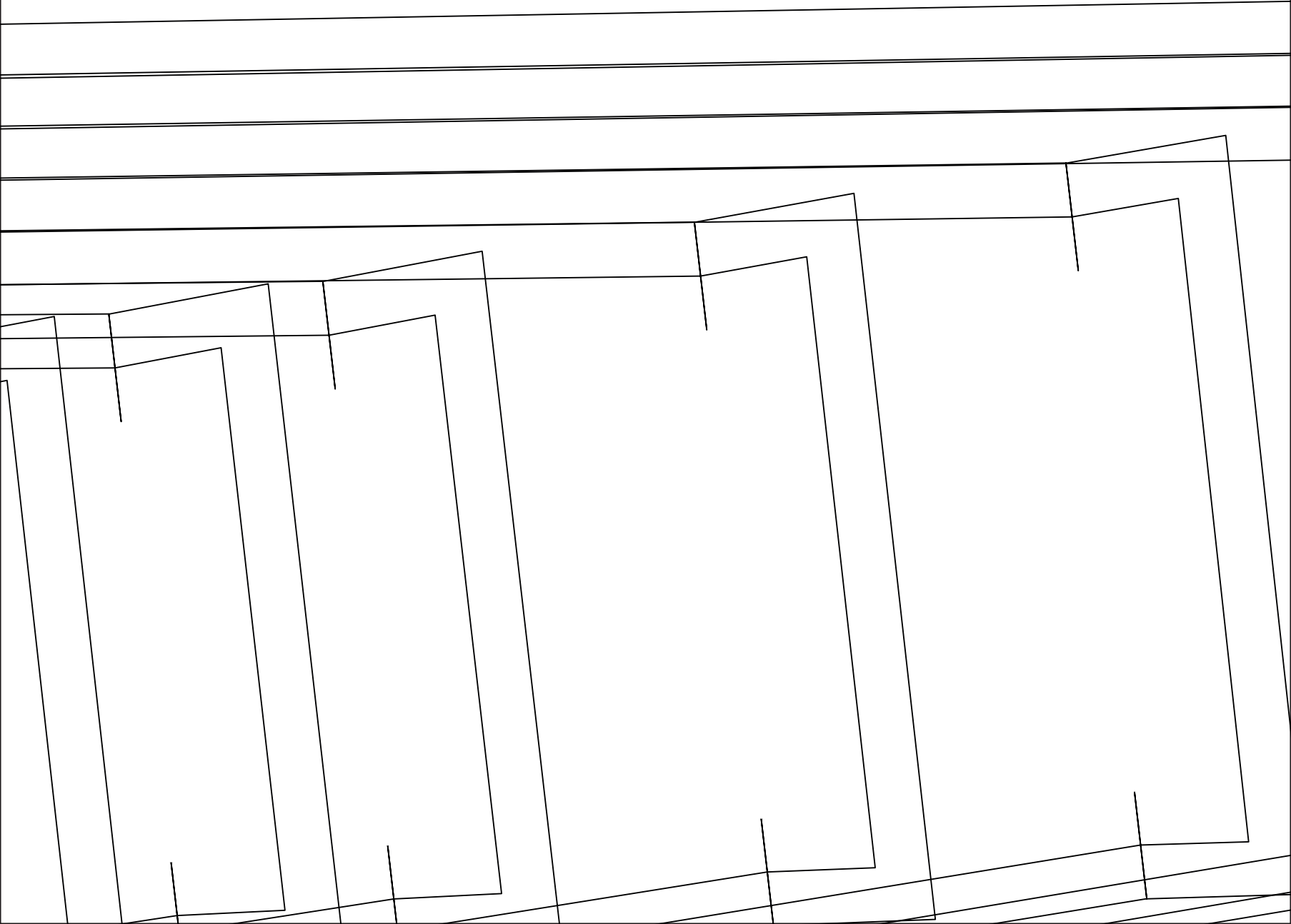

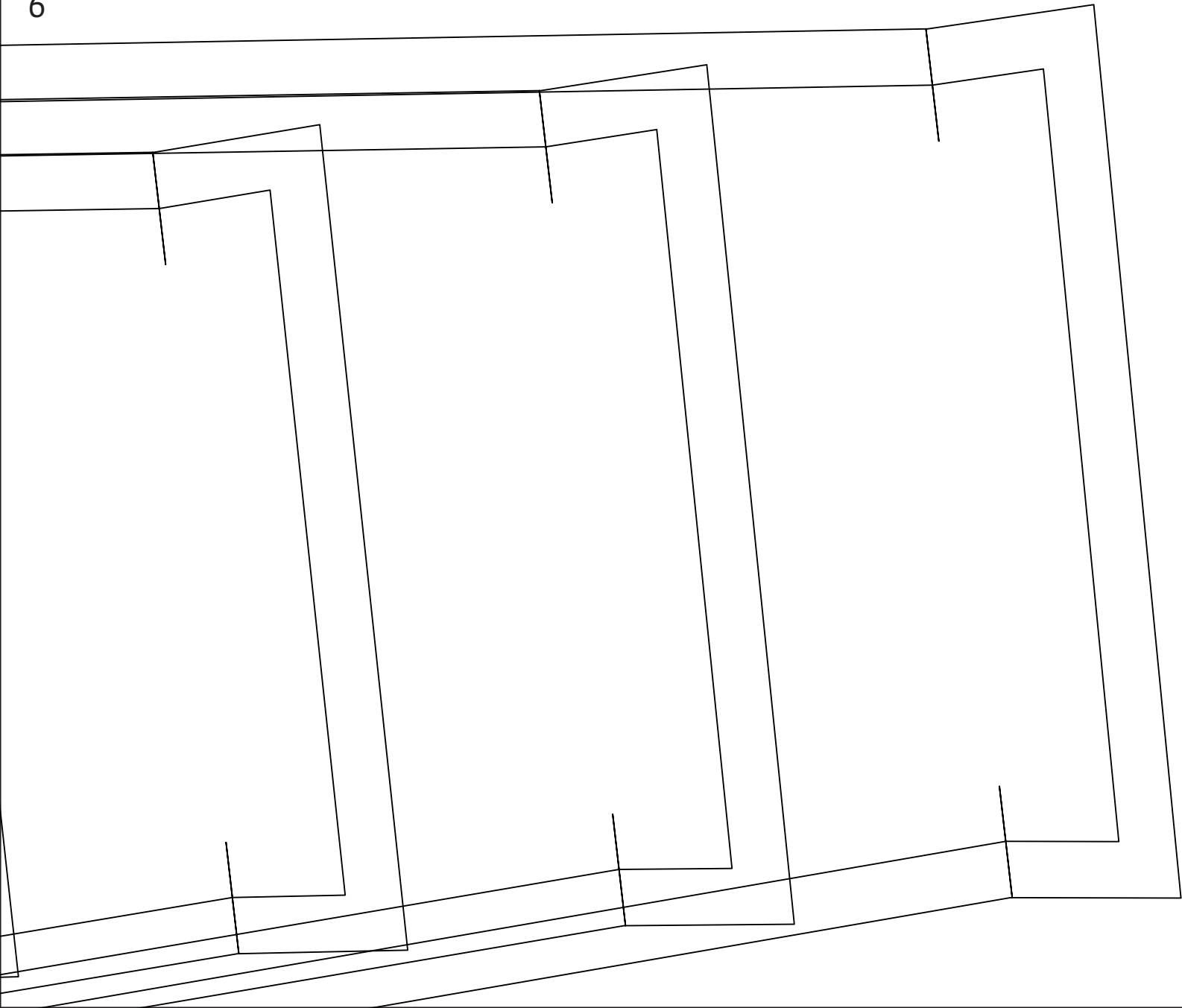

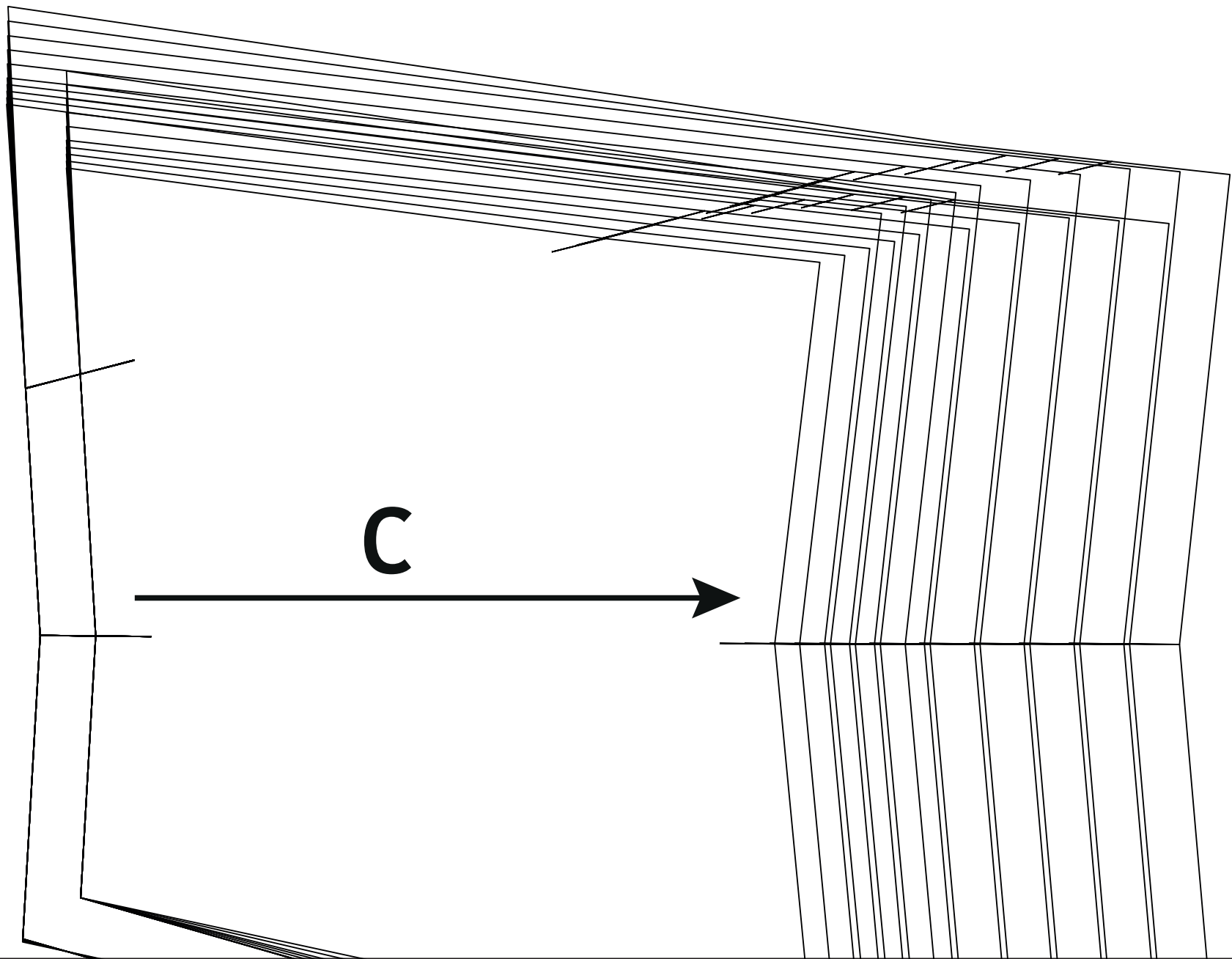

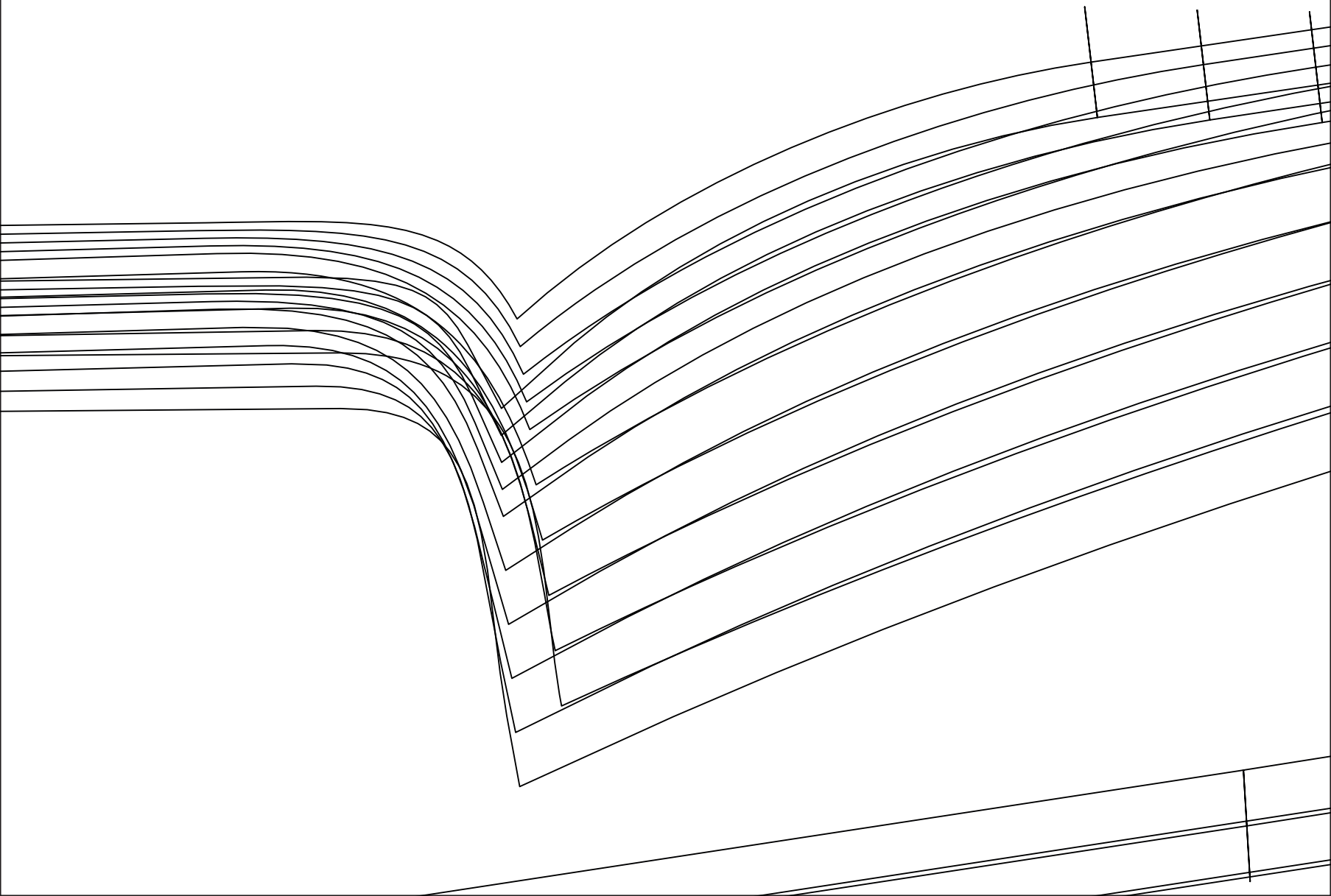

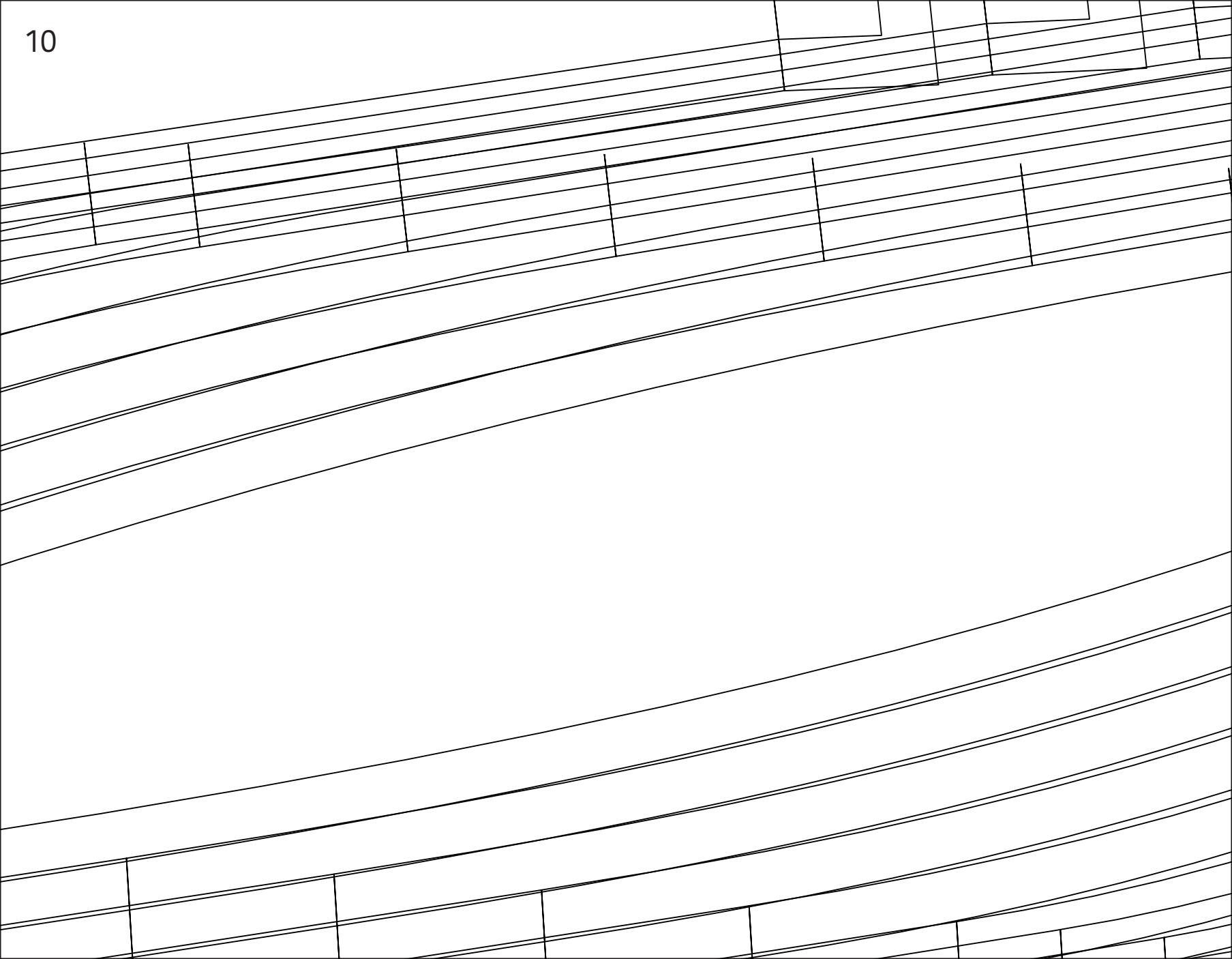

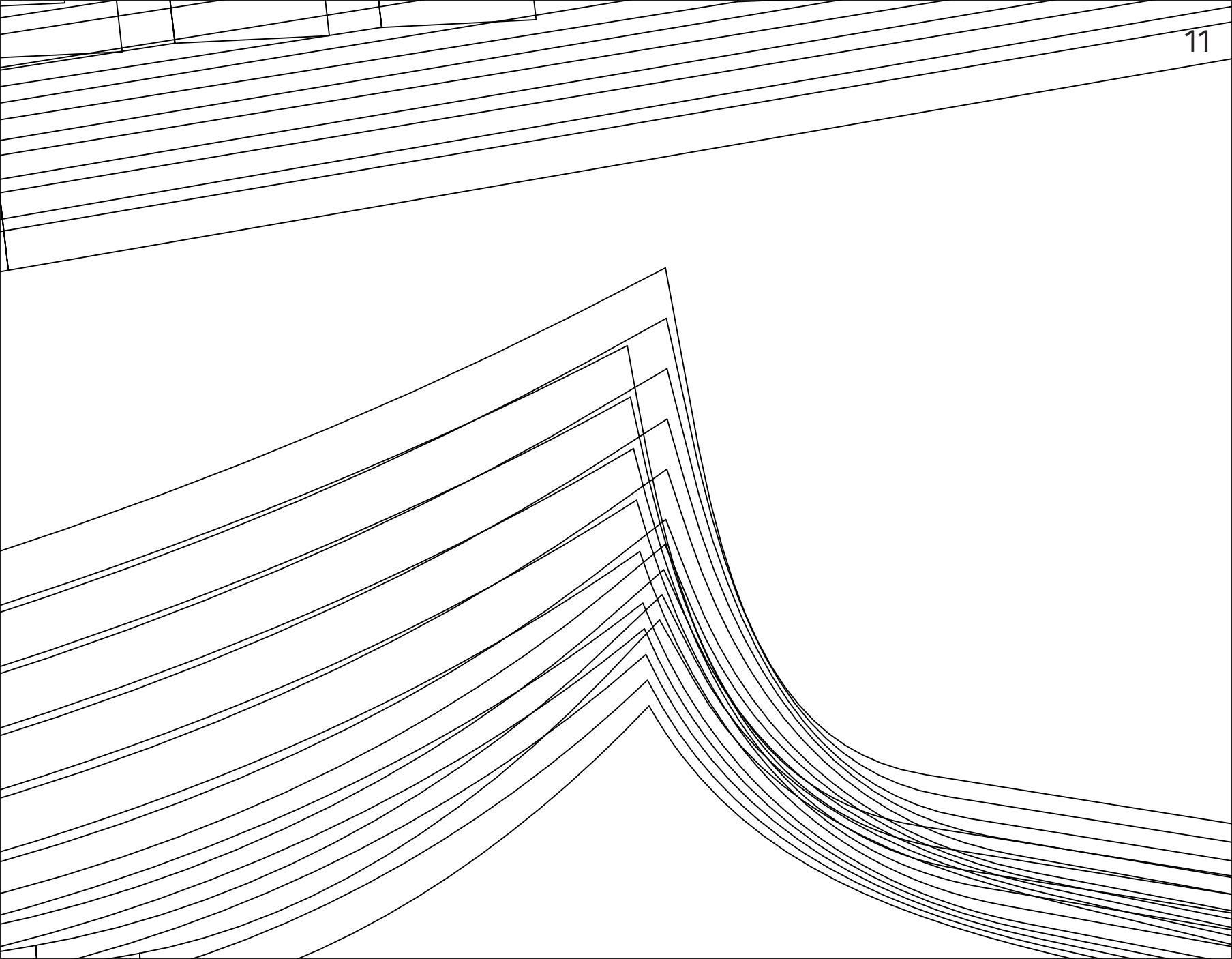

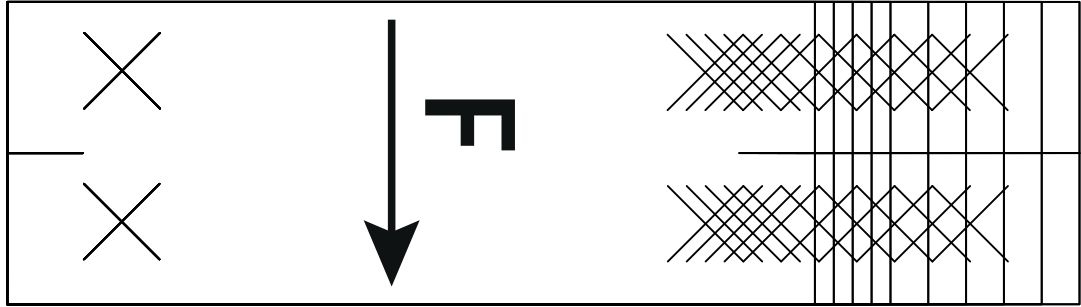

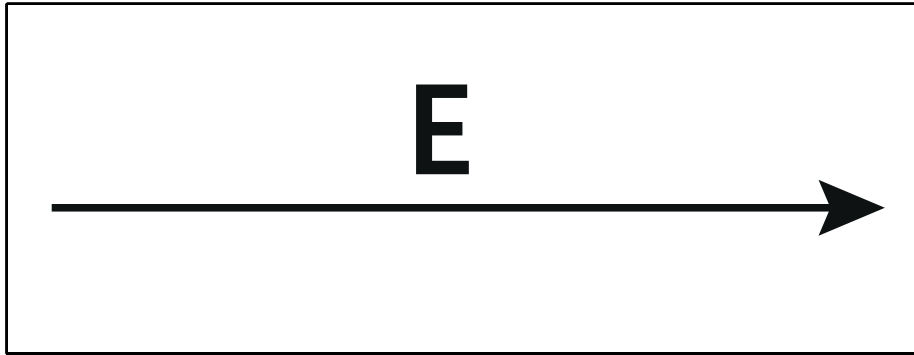

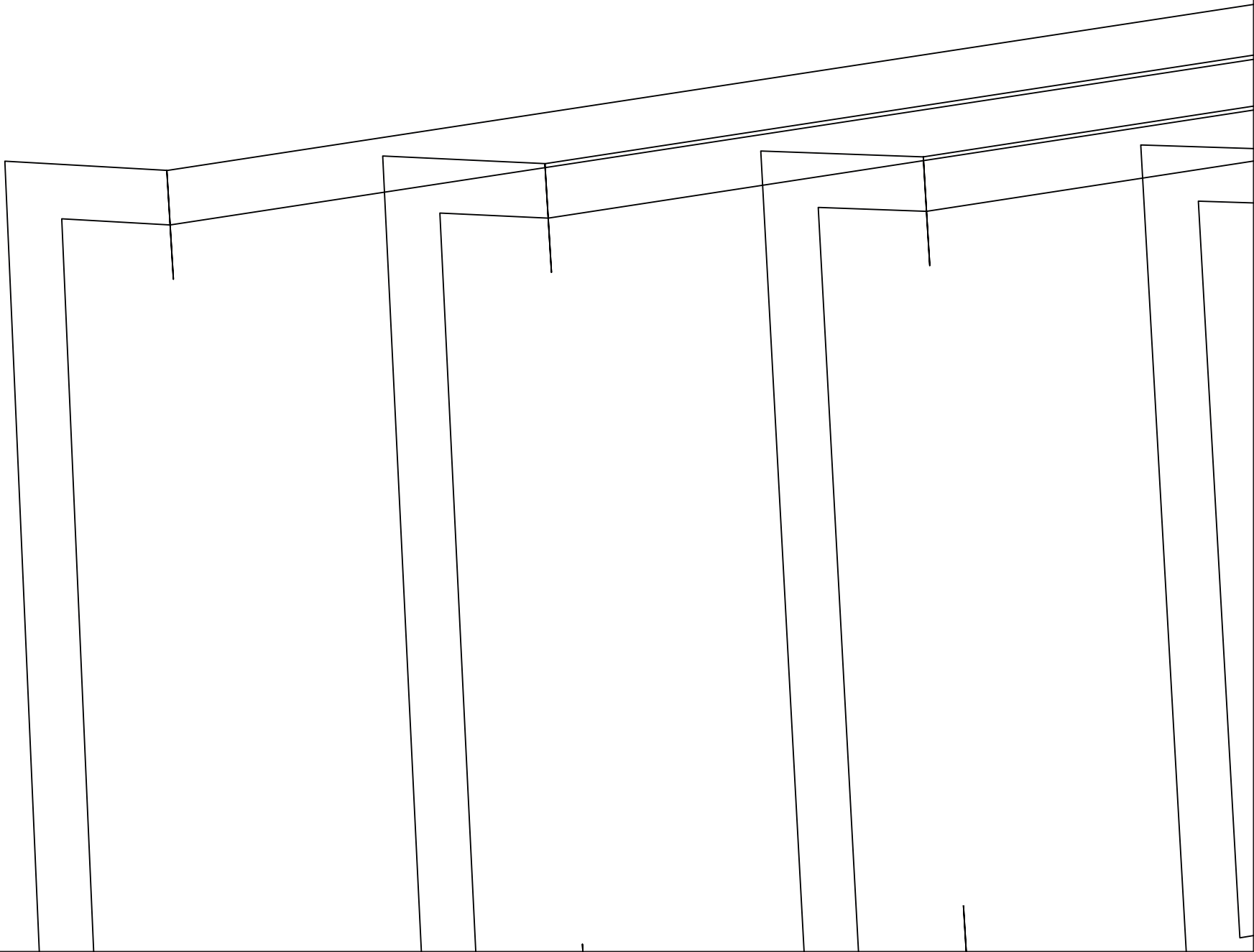

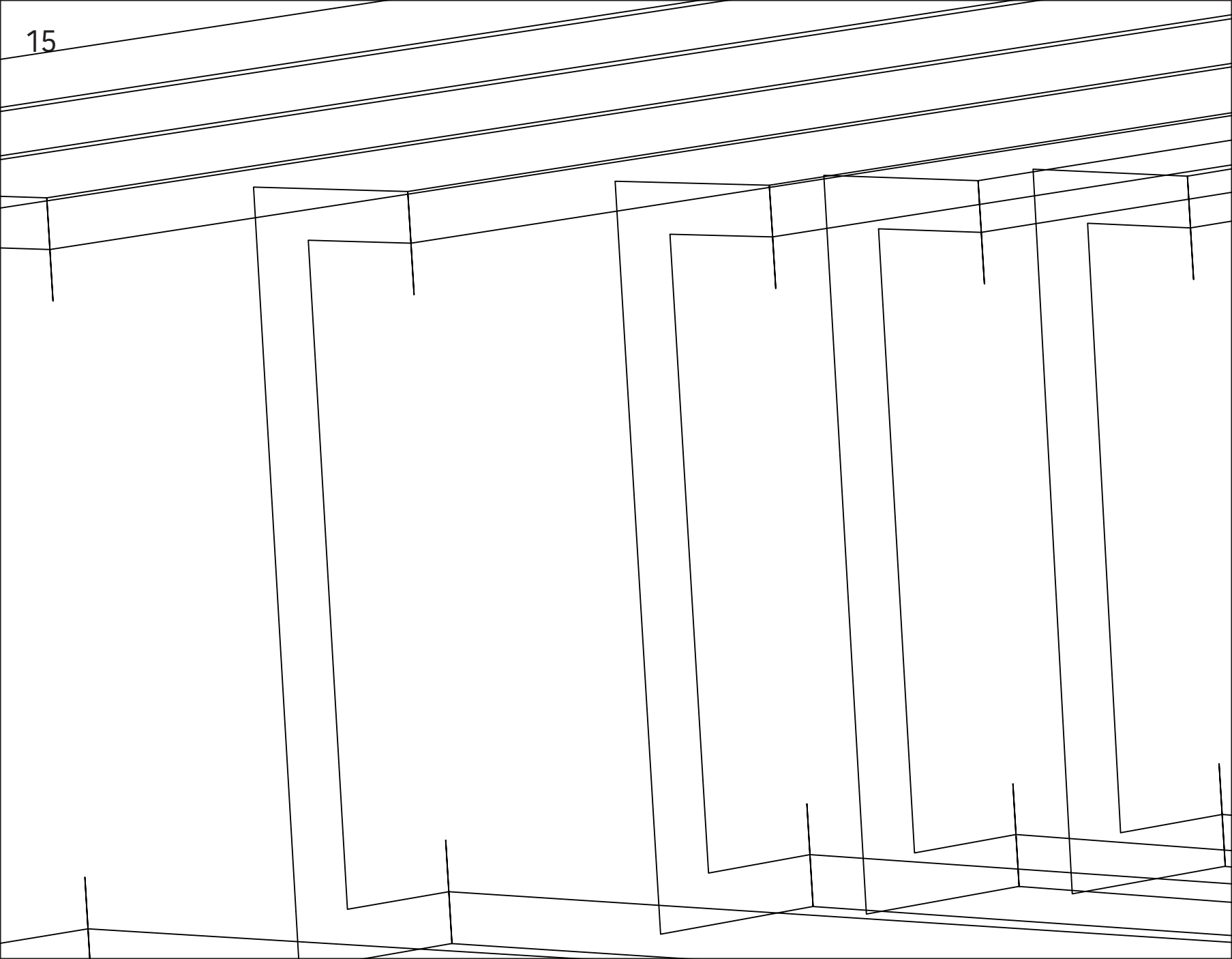

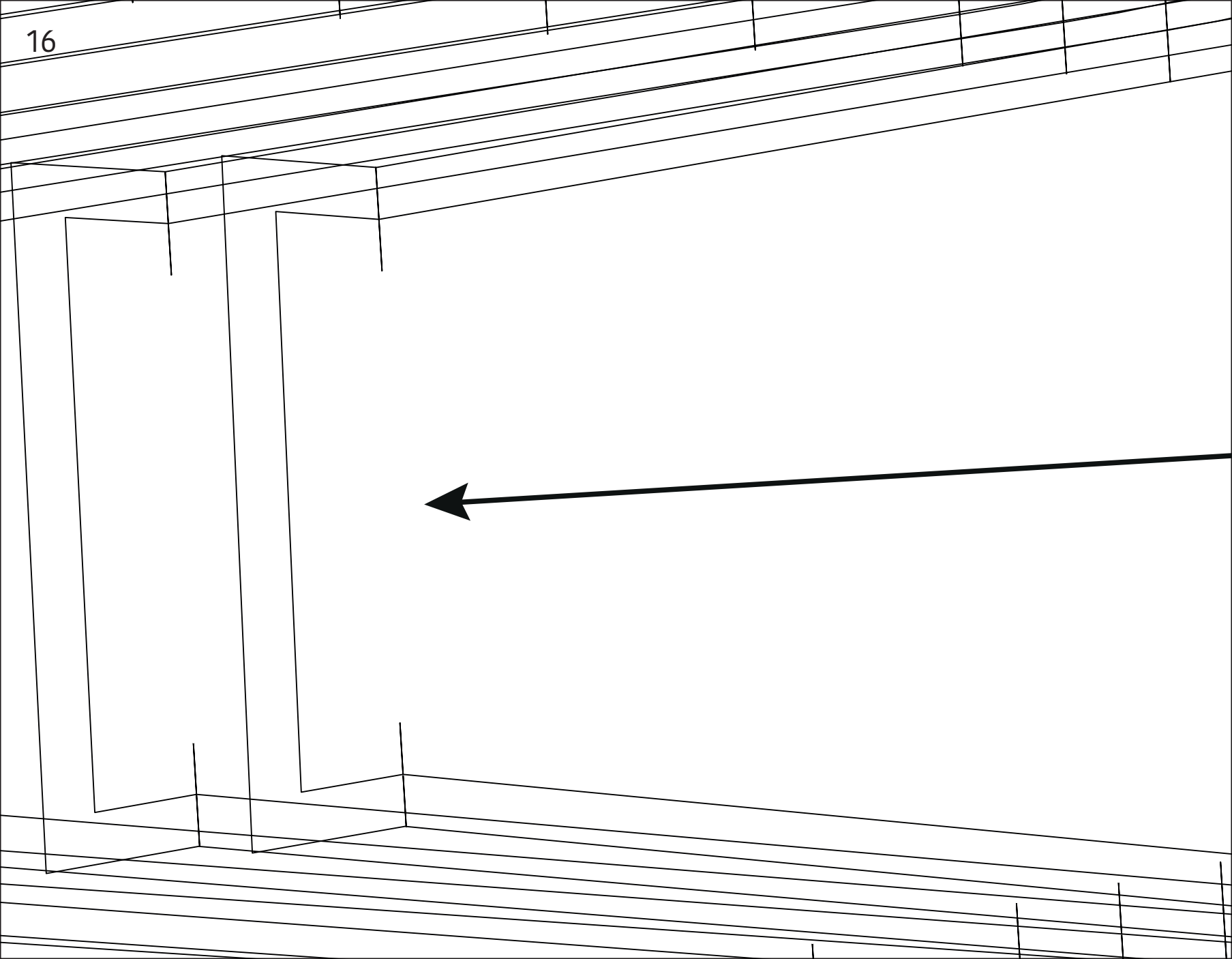



B

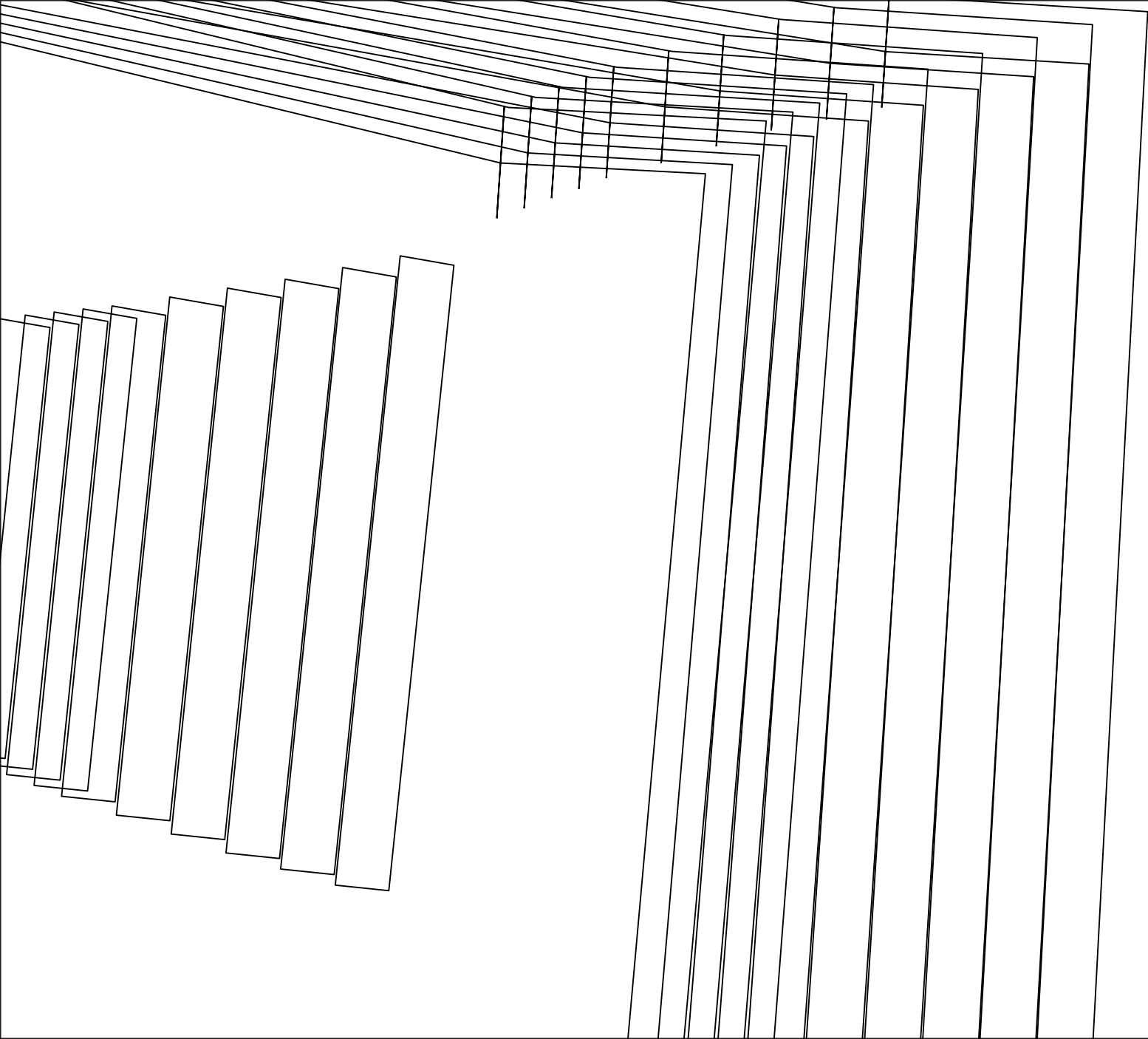

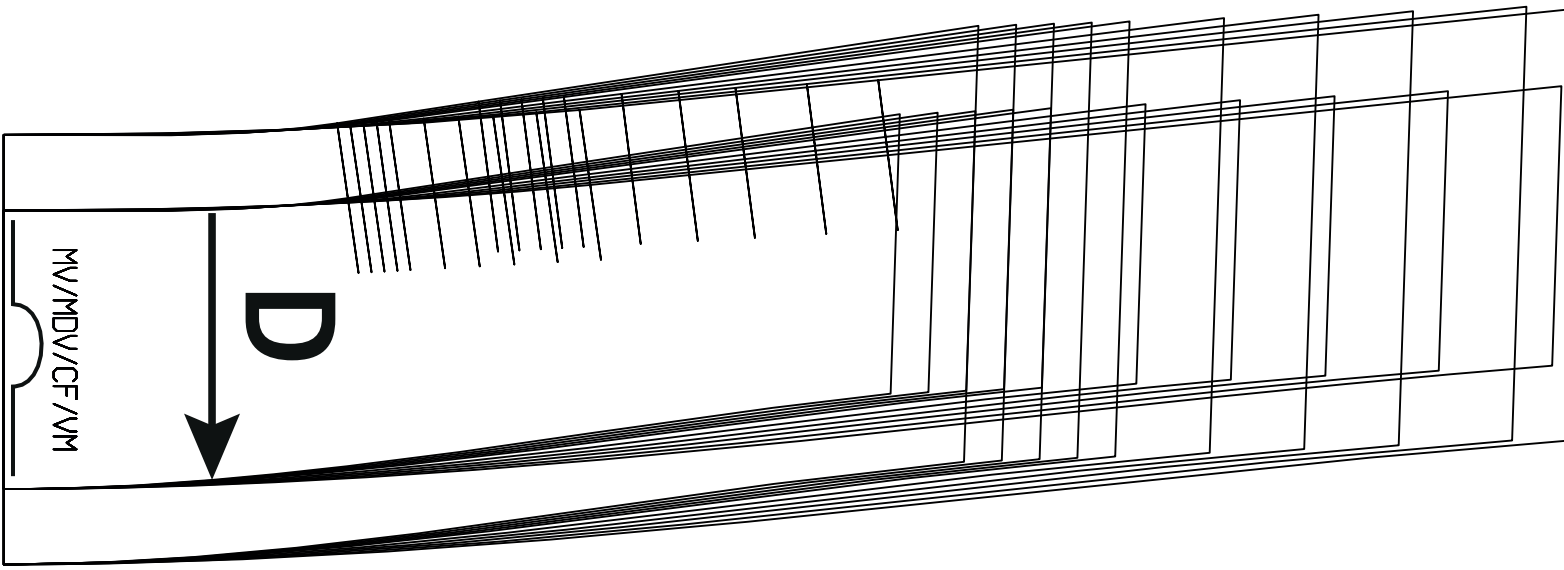

MV/MDV/CF/VM

D

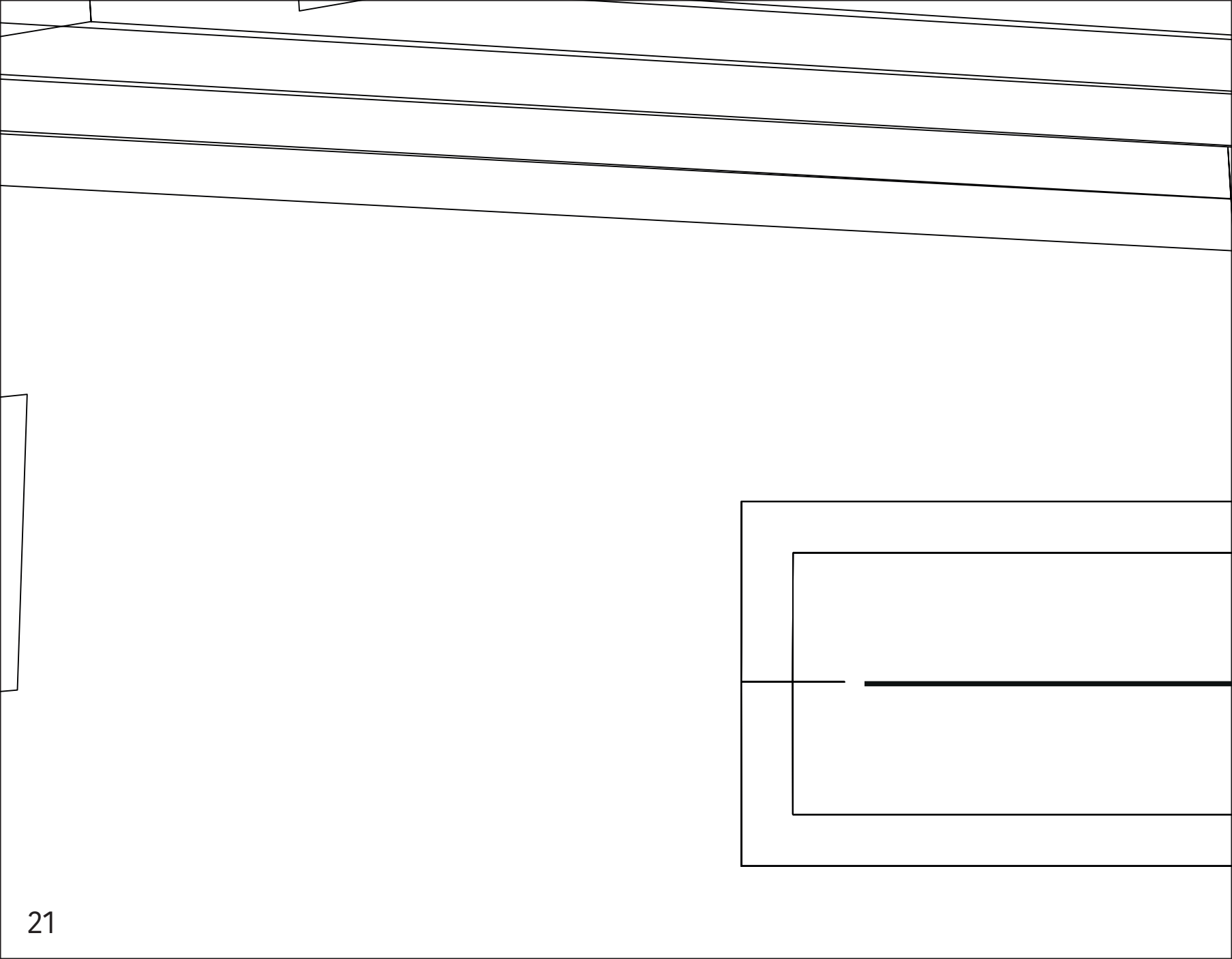

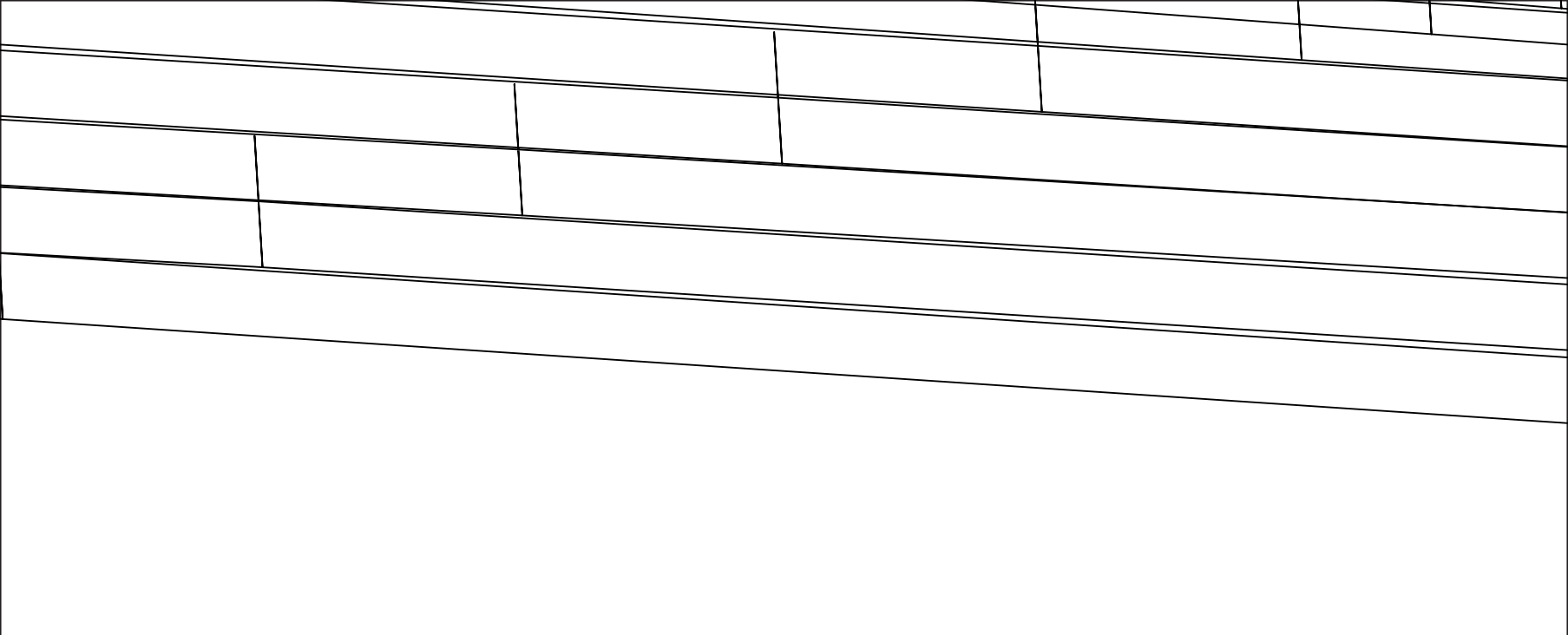

H

