

Patroonschema / Schéma du Patron / Pattern Diagram /
Übersichtsplan zum Zusammenkleben

1	2	3	4	5	6
7	8	9	10	11	12
13	14	15	16	17	18
19	20	21	22	23	

Controlevierkant / Carré de controle
/ Test square / Kontrollquadrat

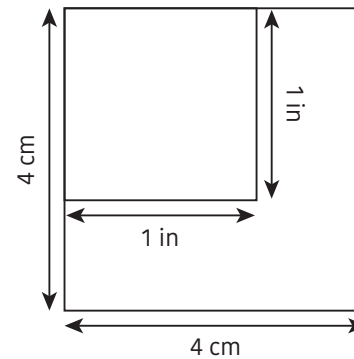

Kennet

Sweater / Sweat /
Jumper / Sweatshirt

Patroondelen / Pièces du patron /
Pattern pieces / Schnittteile:

- A** voorpand / devant / front panel /
Vorderteil
- B** rugpand / dos / back panel /
Rückenteil
- C** mouw / manche / sleeve / Ärmel
- D** overmouw / surmanche /
upper sleeve / Oberer Ärmel
- E** halsboord / bord encolure / collar /
Halsbund
- F** zak / poche / pocket / Tasche

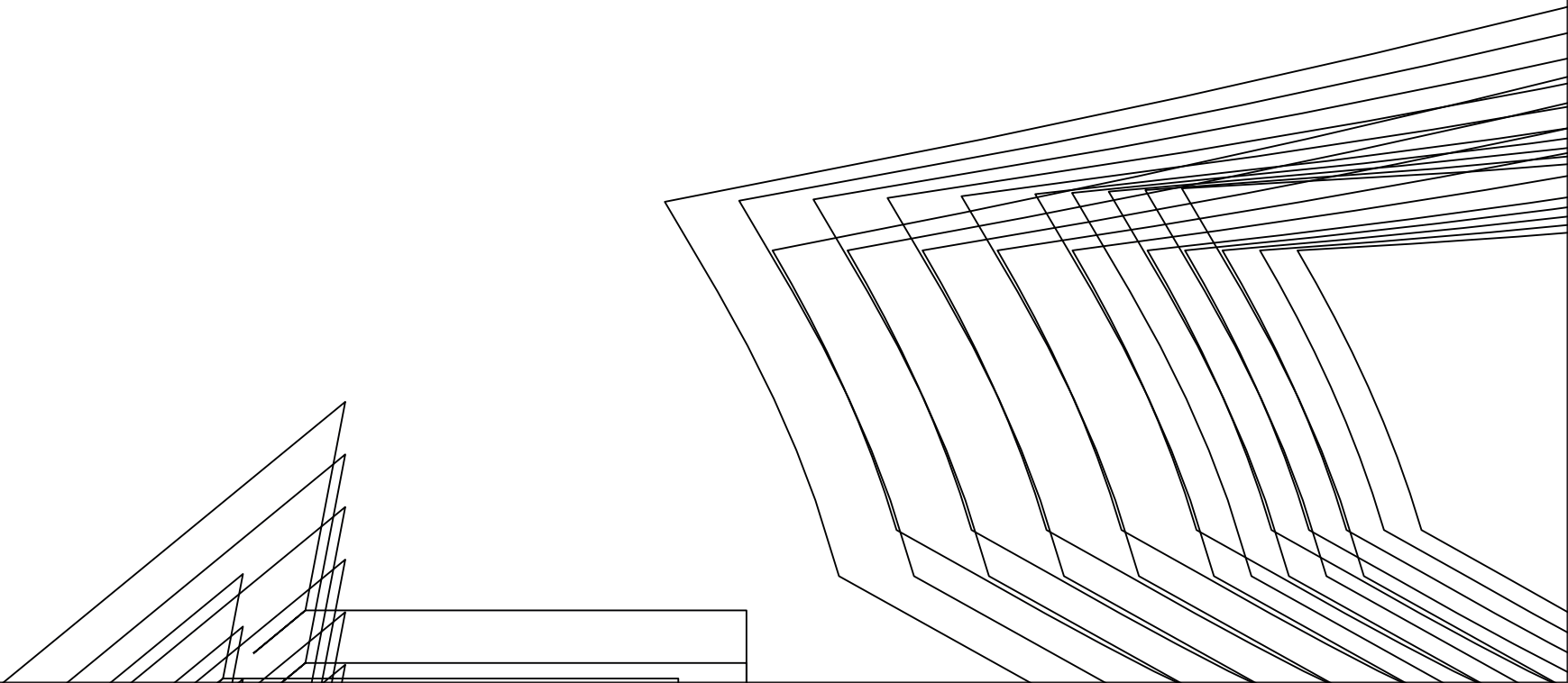

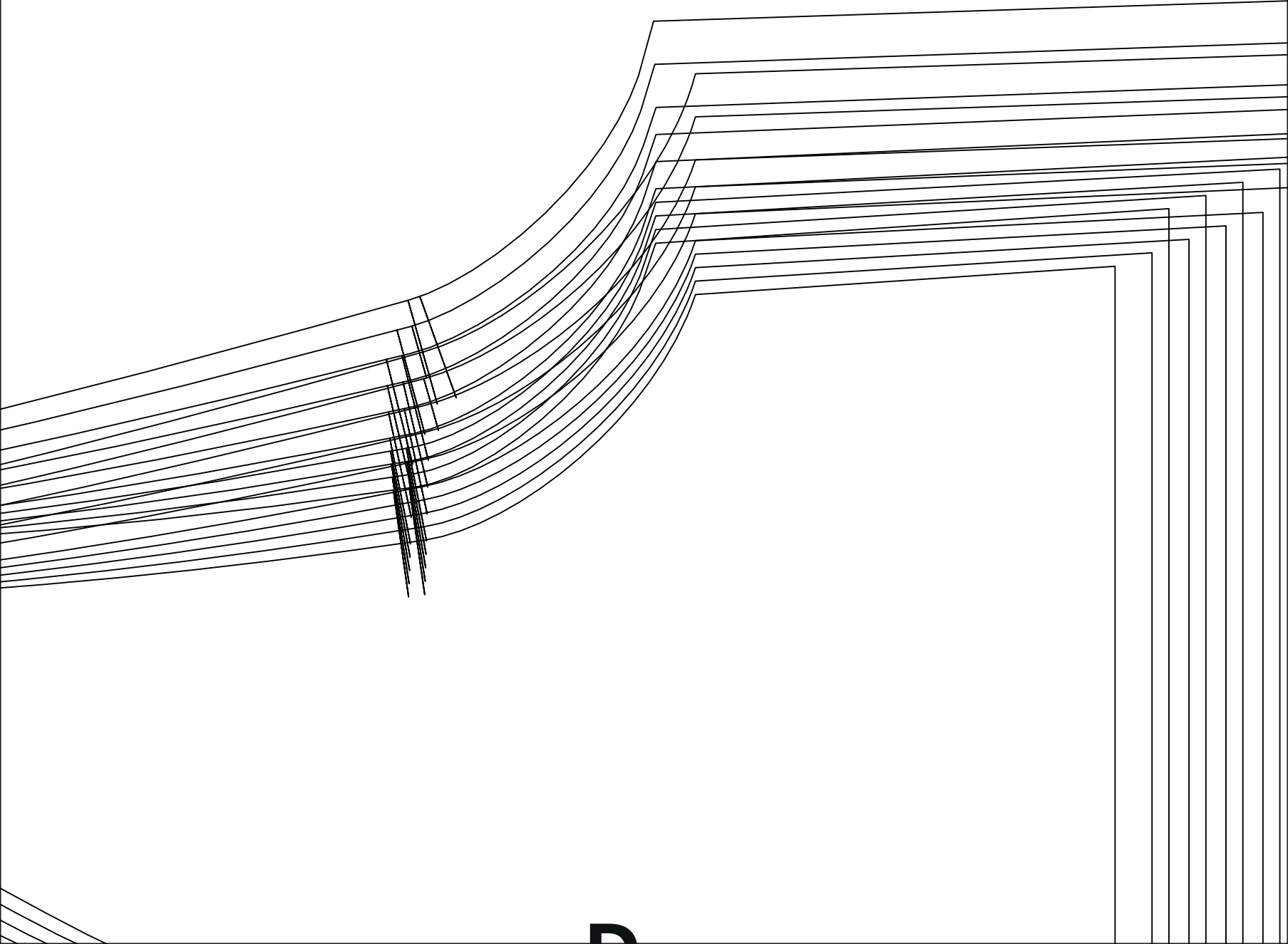

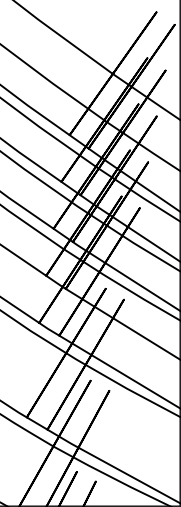
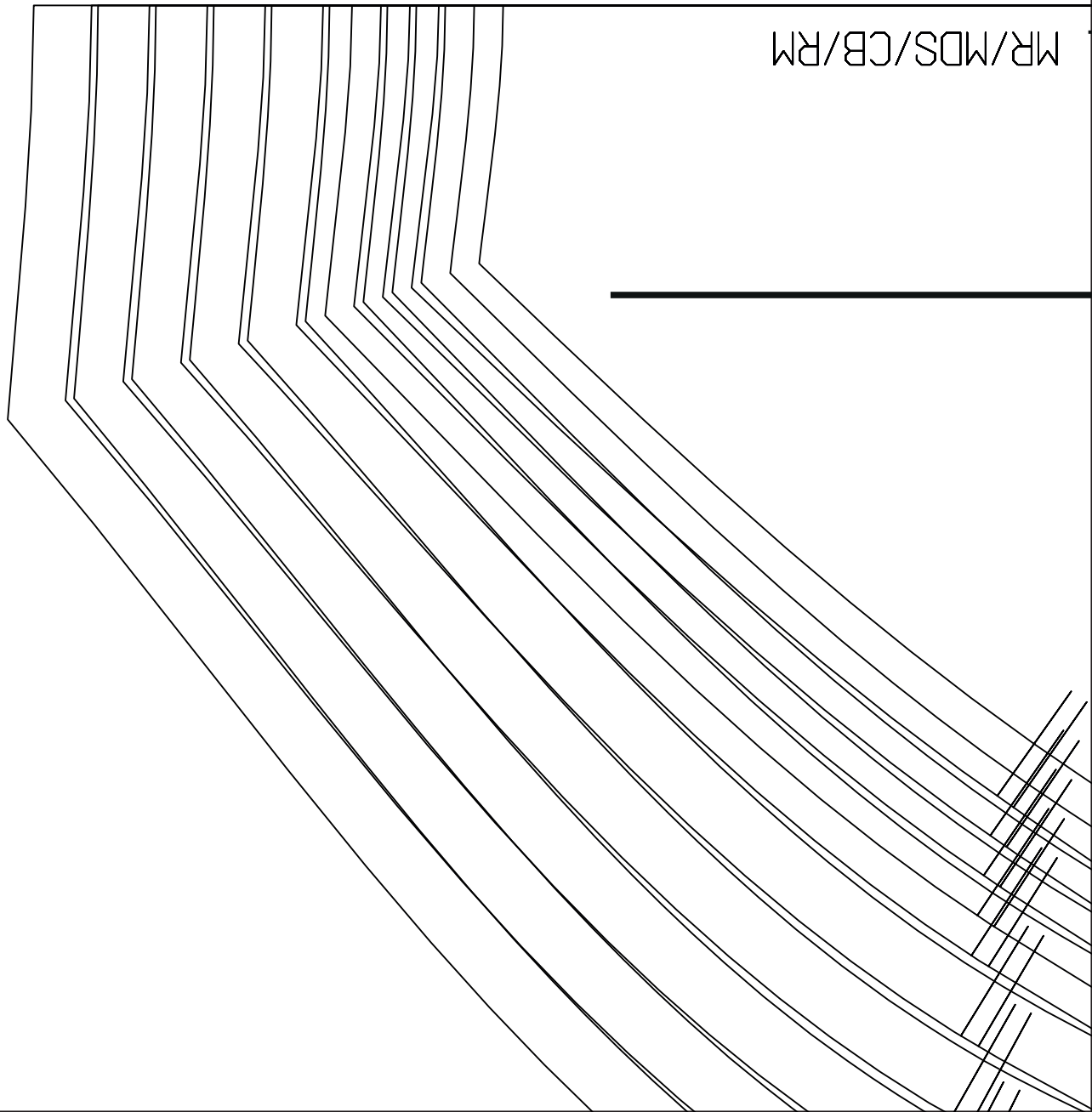
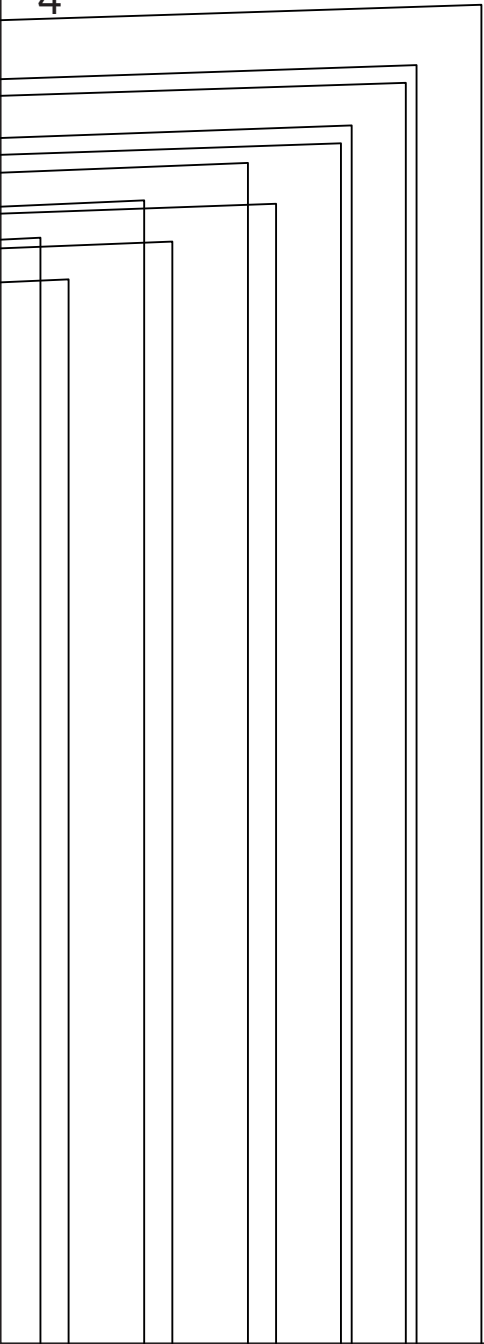

5



B

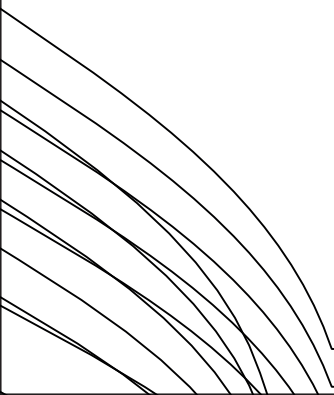

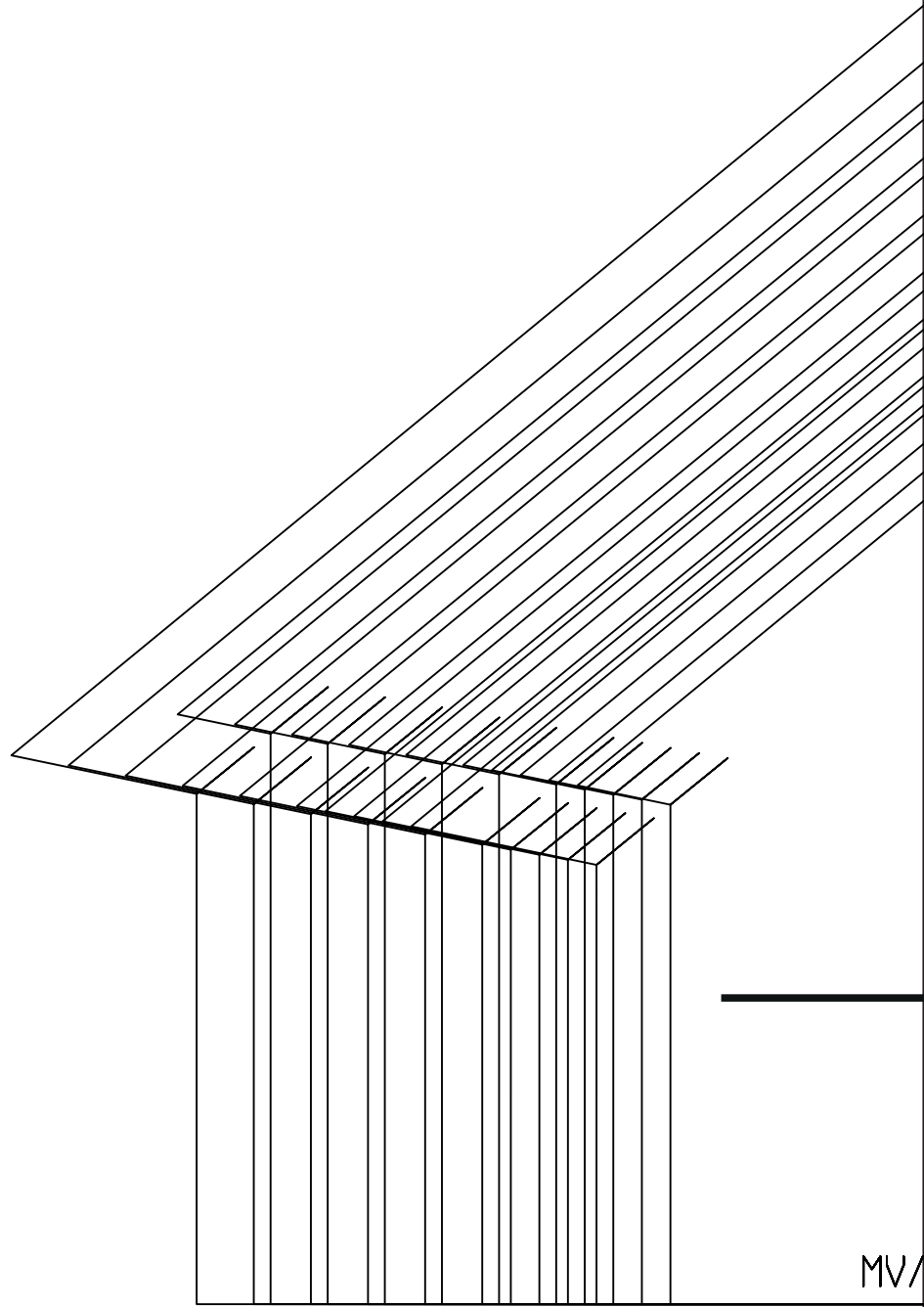

MV

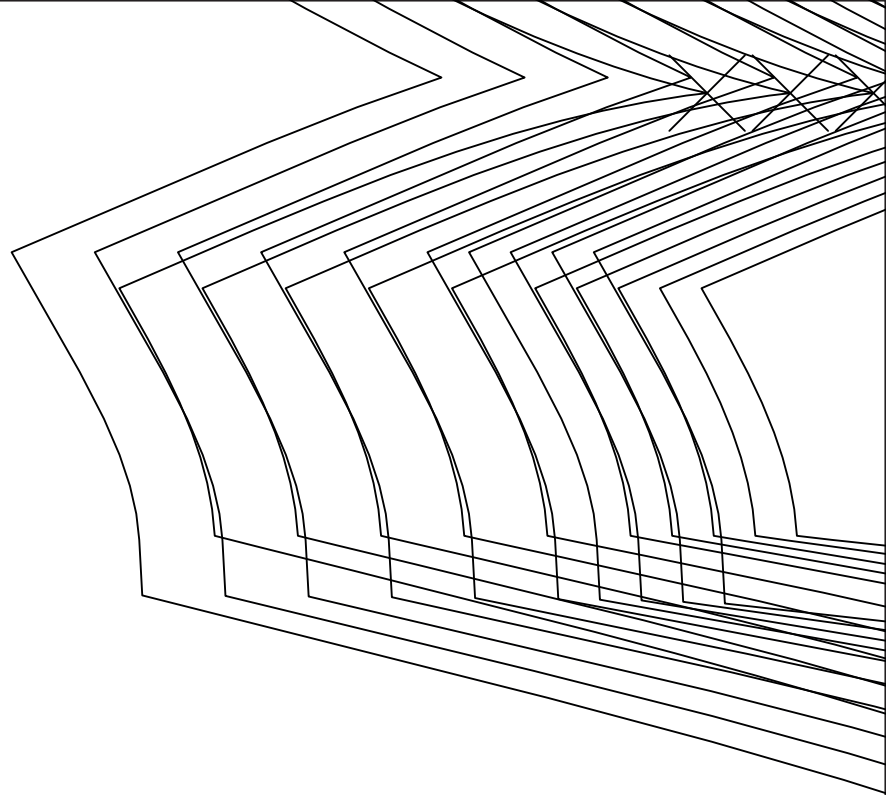
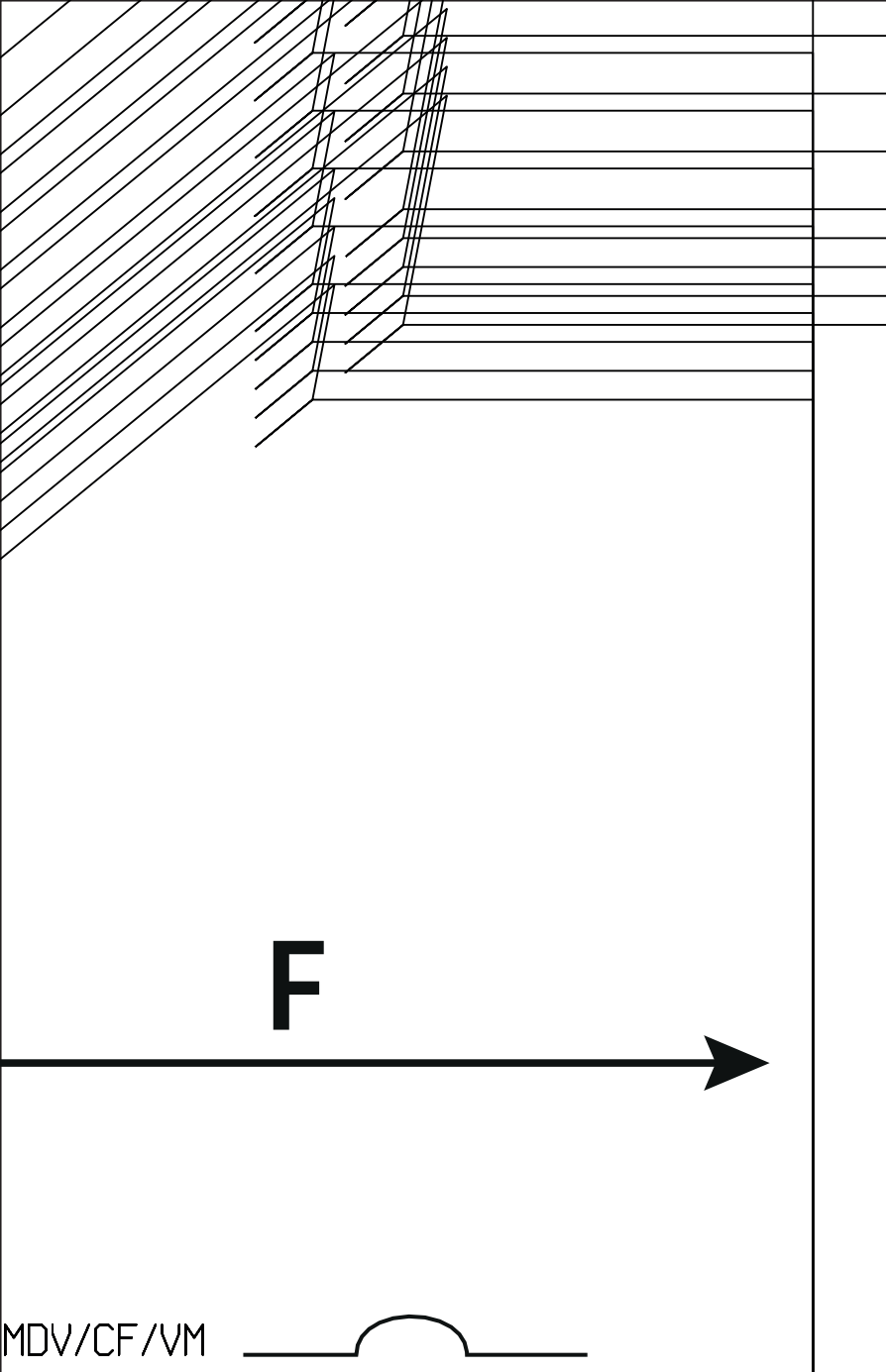

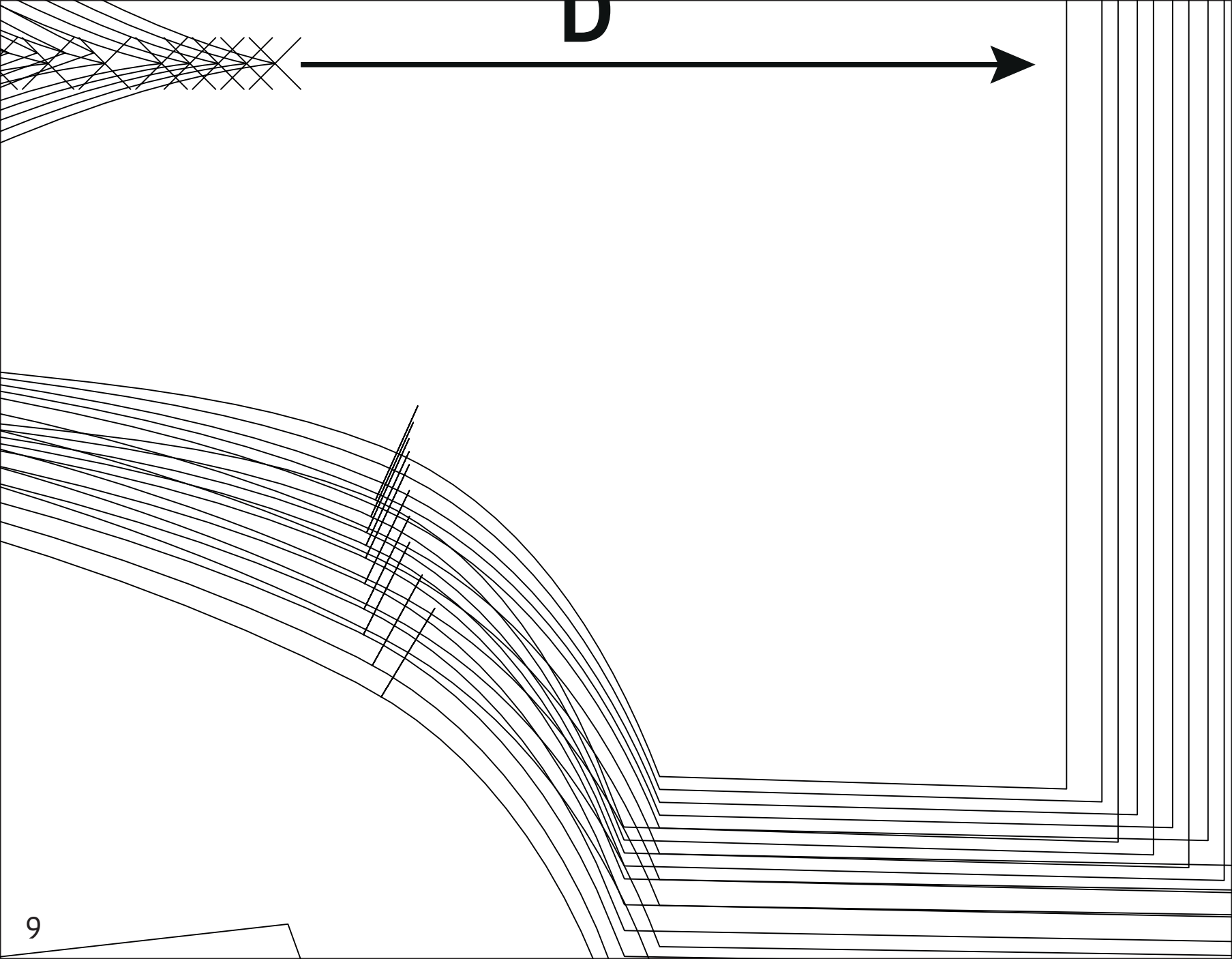

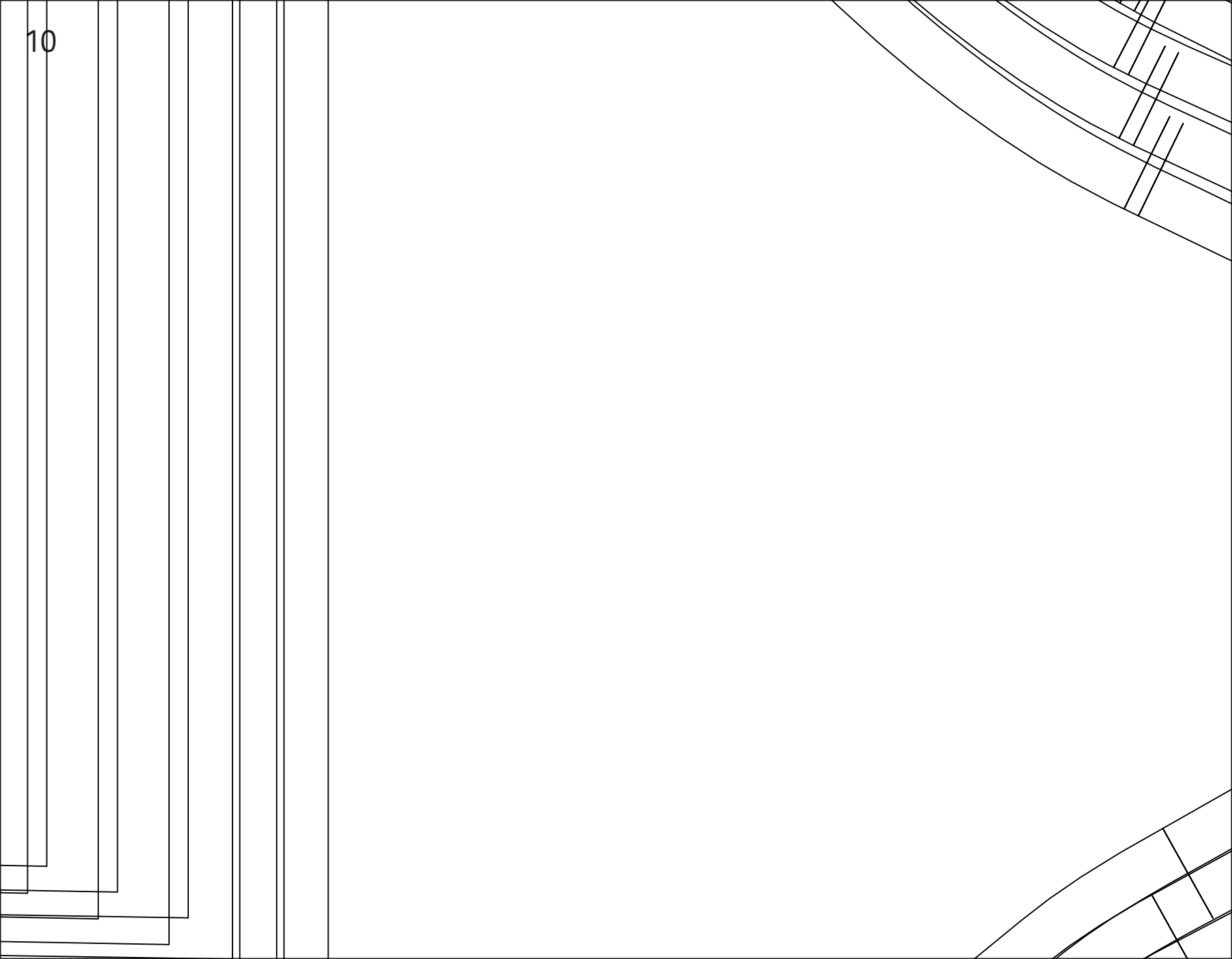

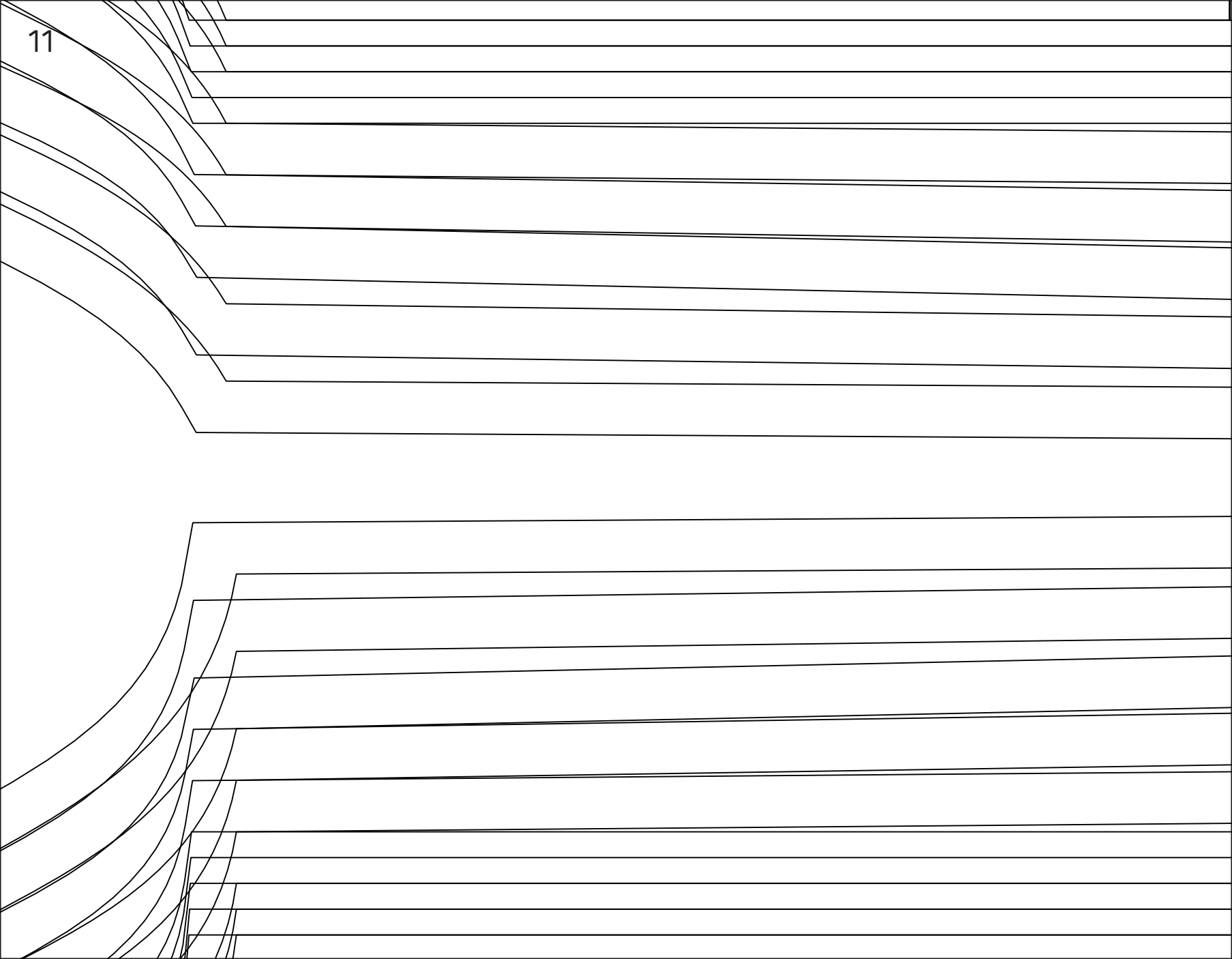

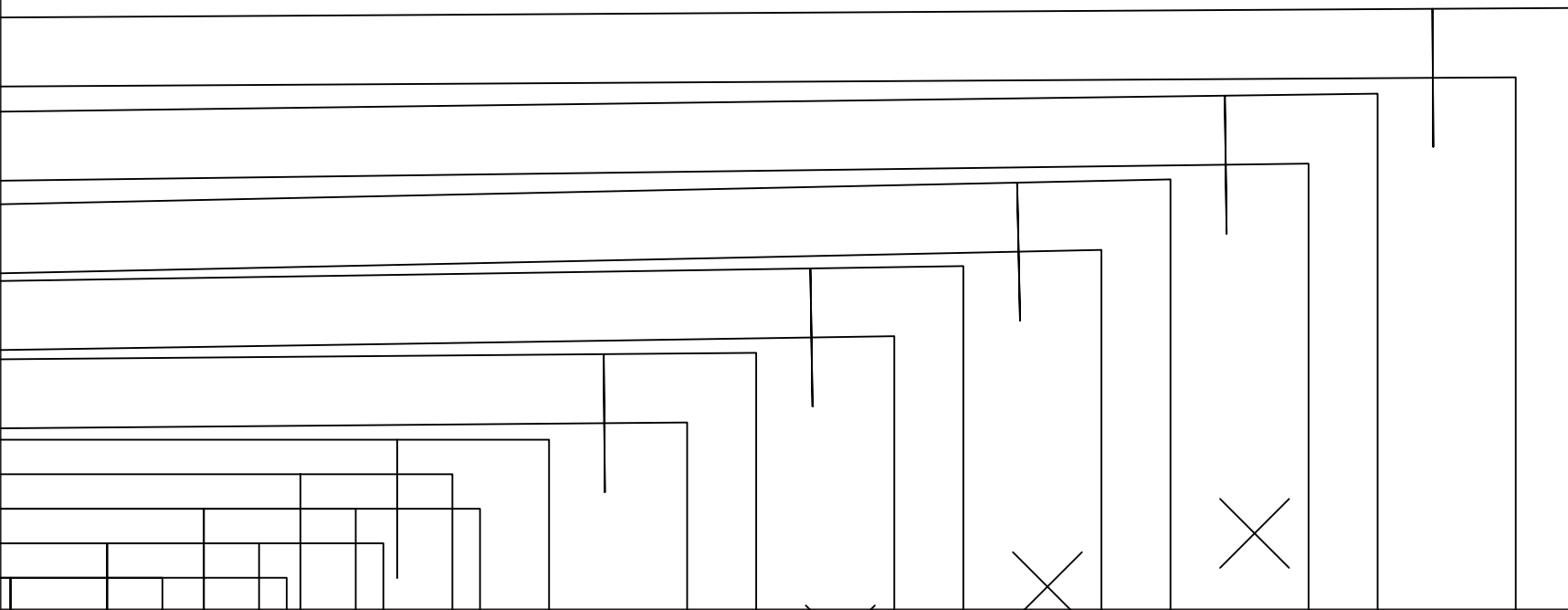
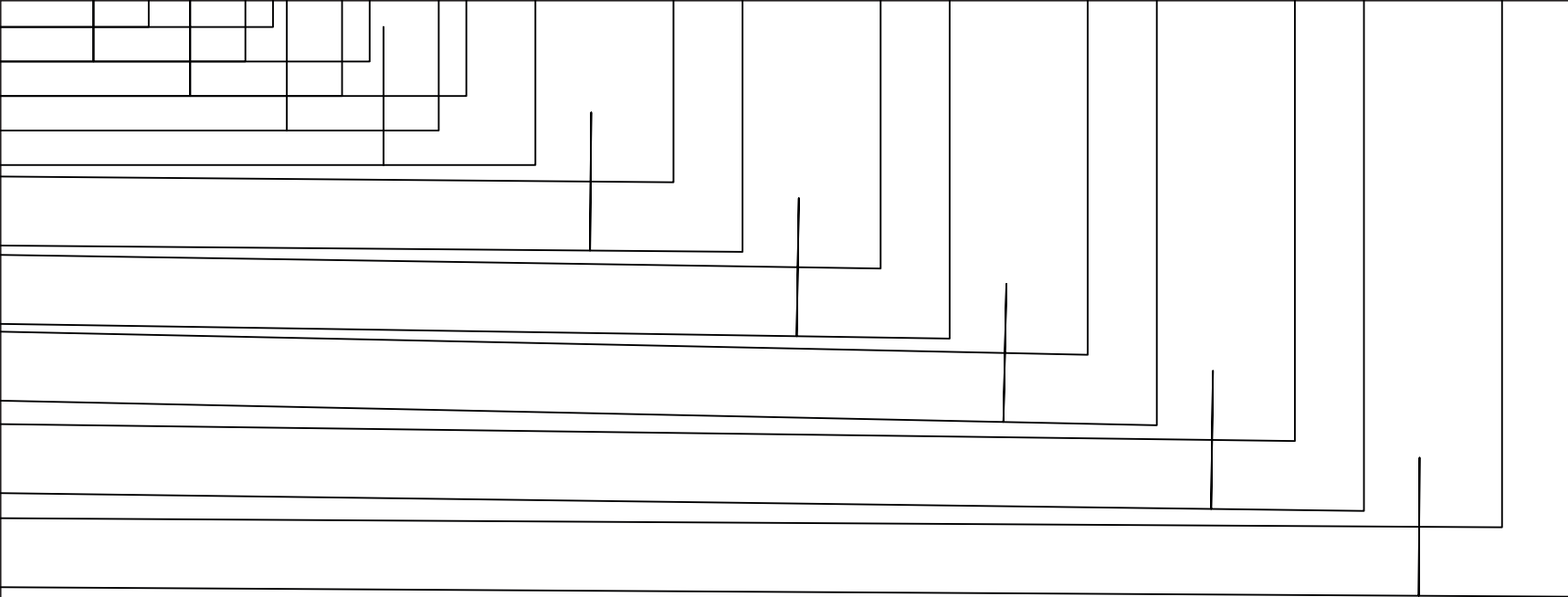

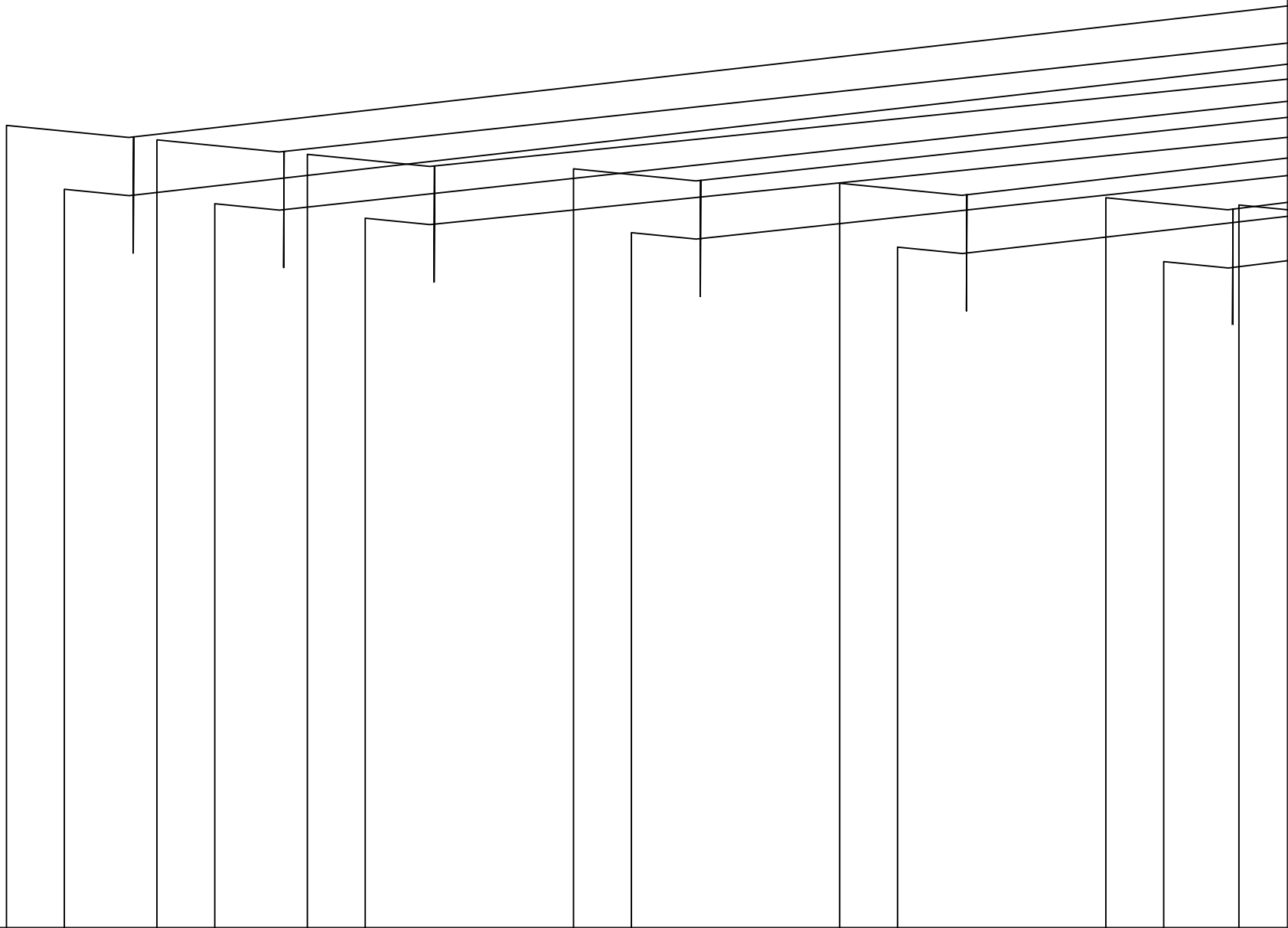

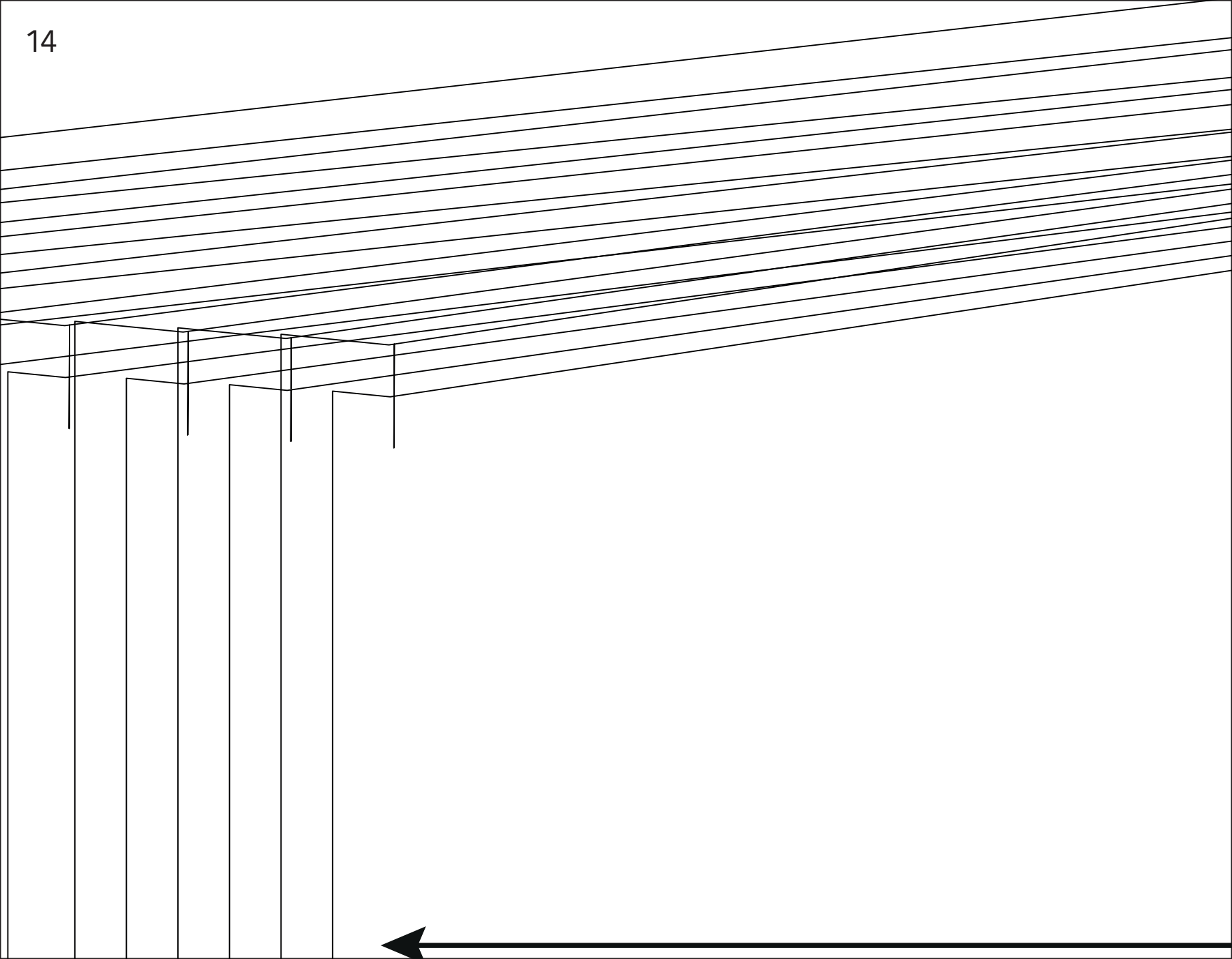

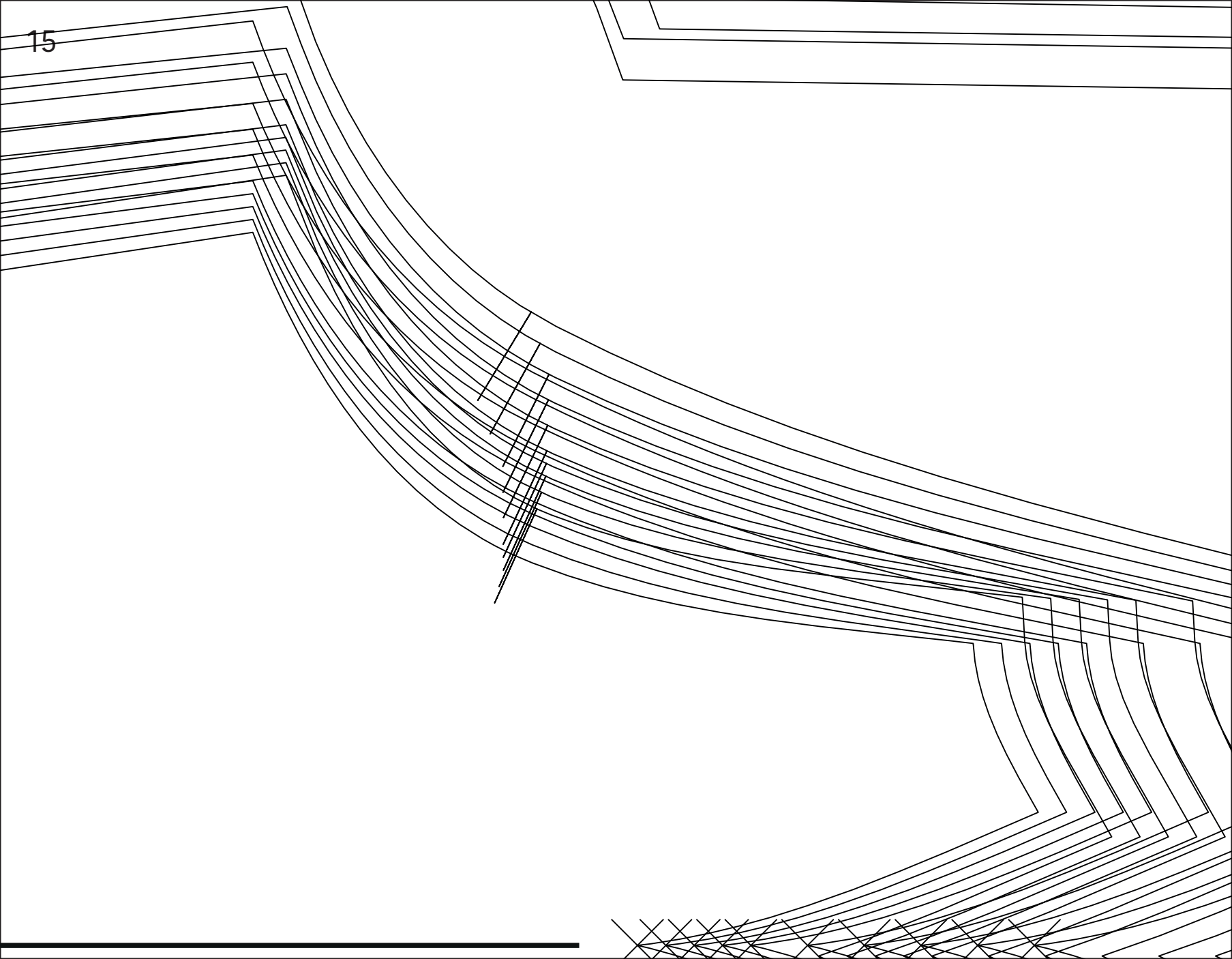

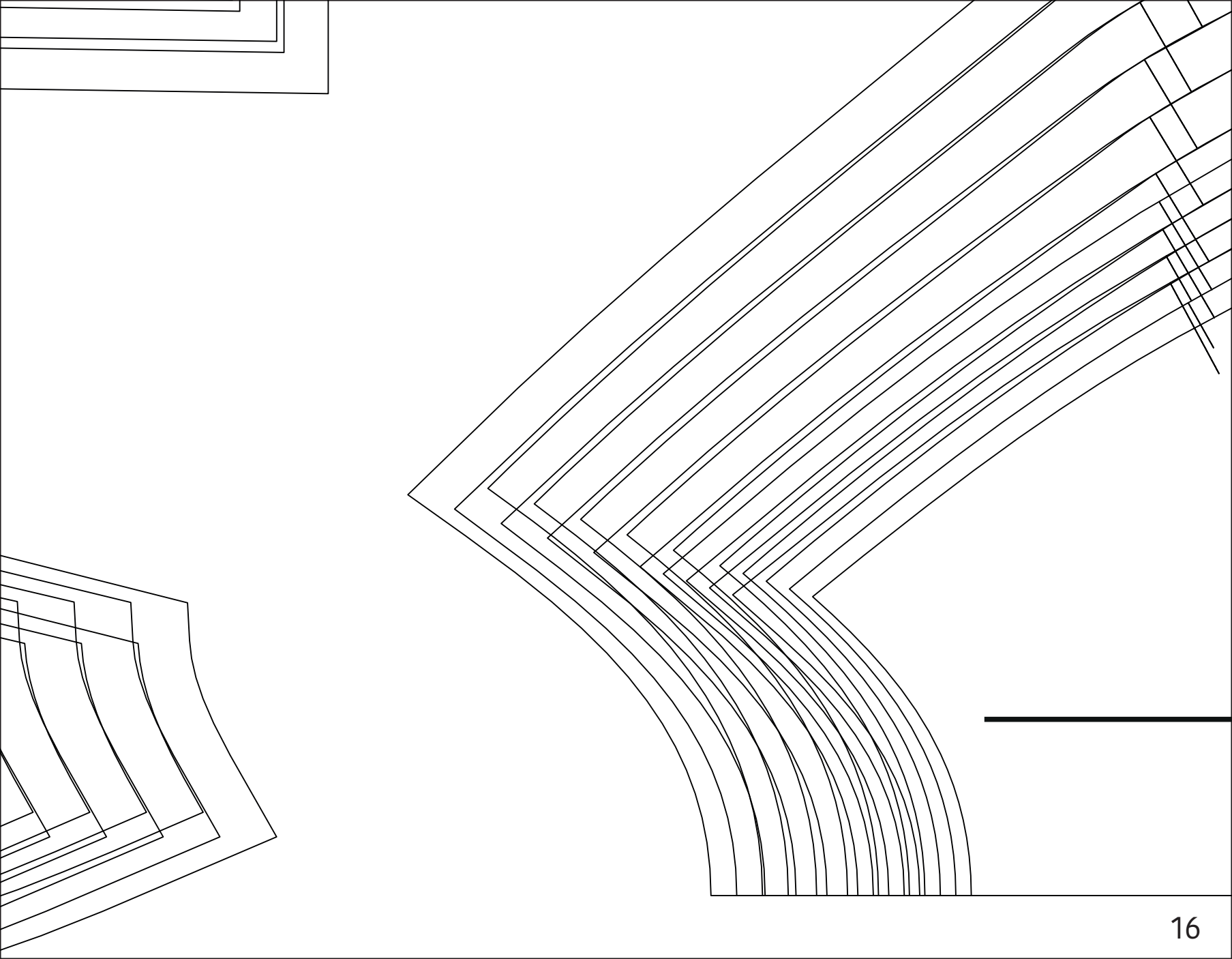

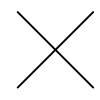
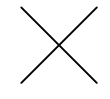
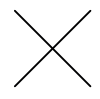
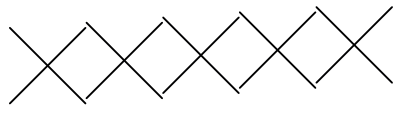
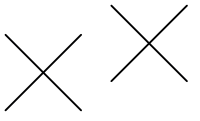
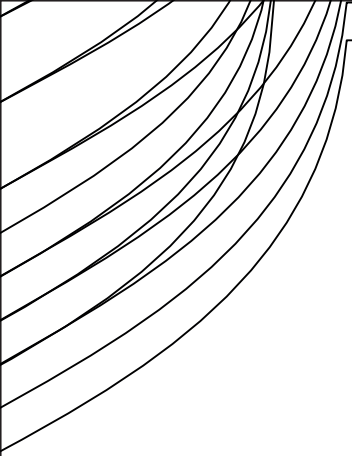

A

MV/MDV/CF/VM



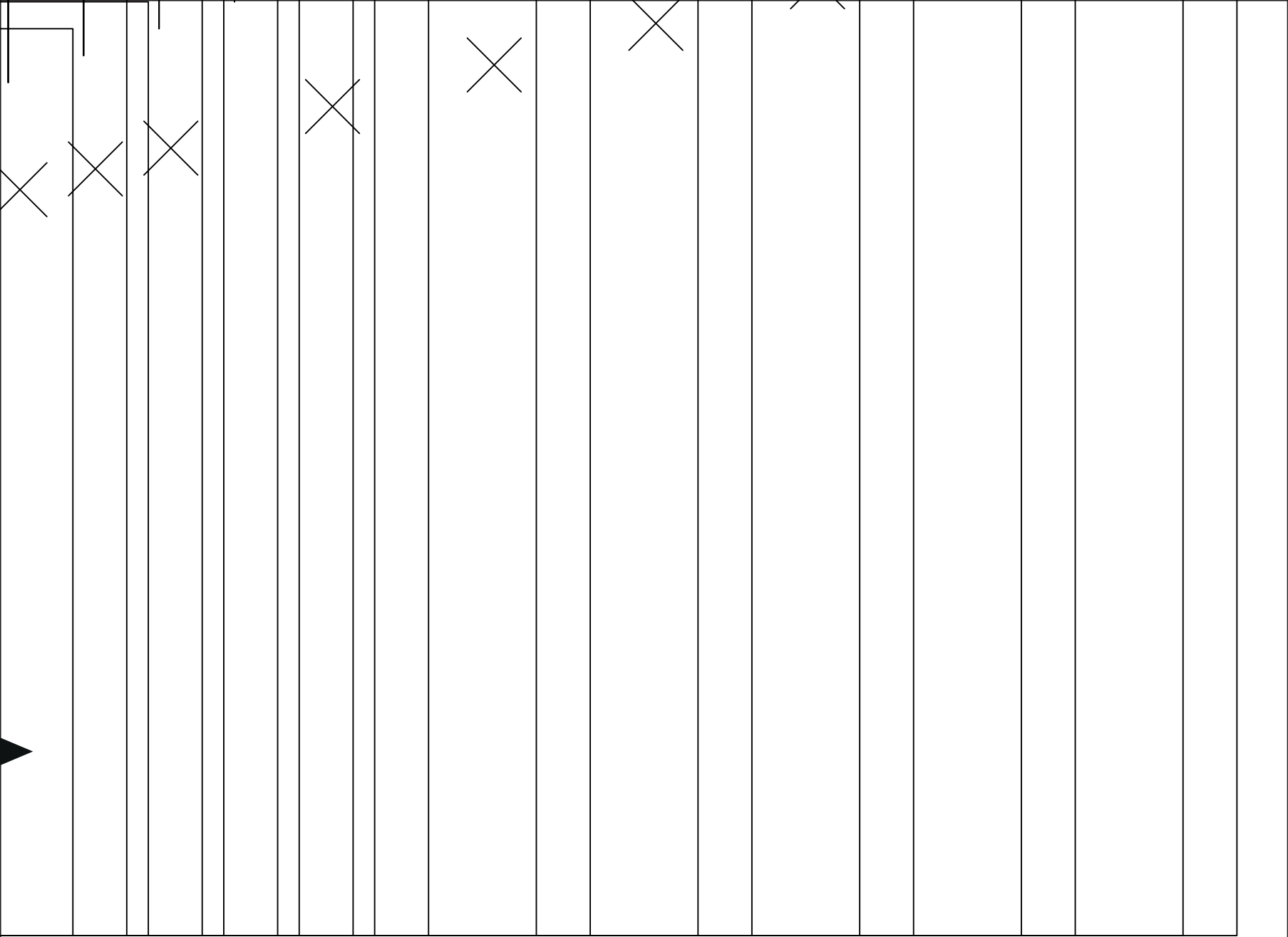

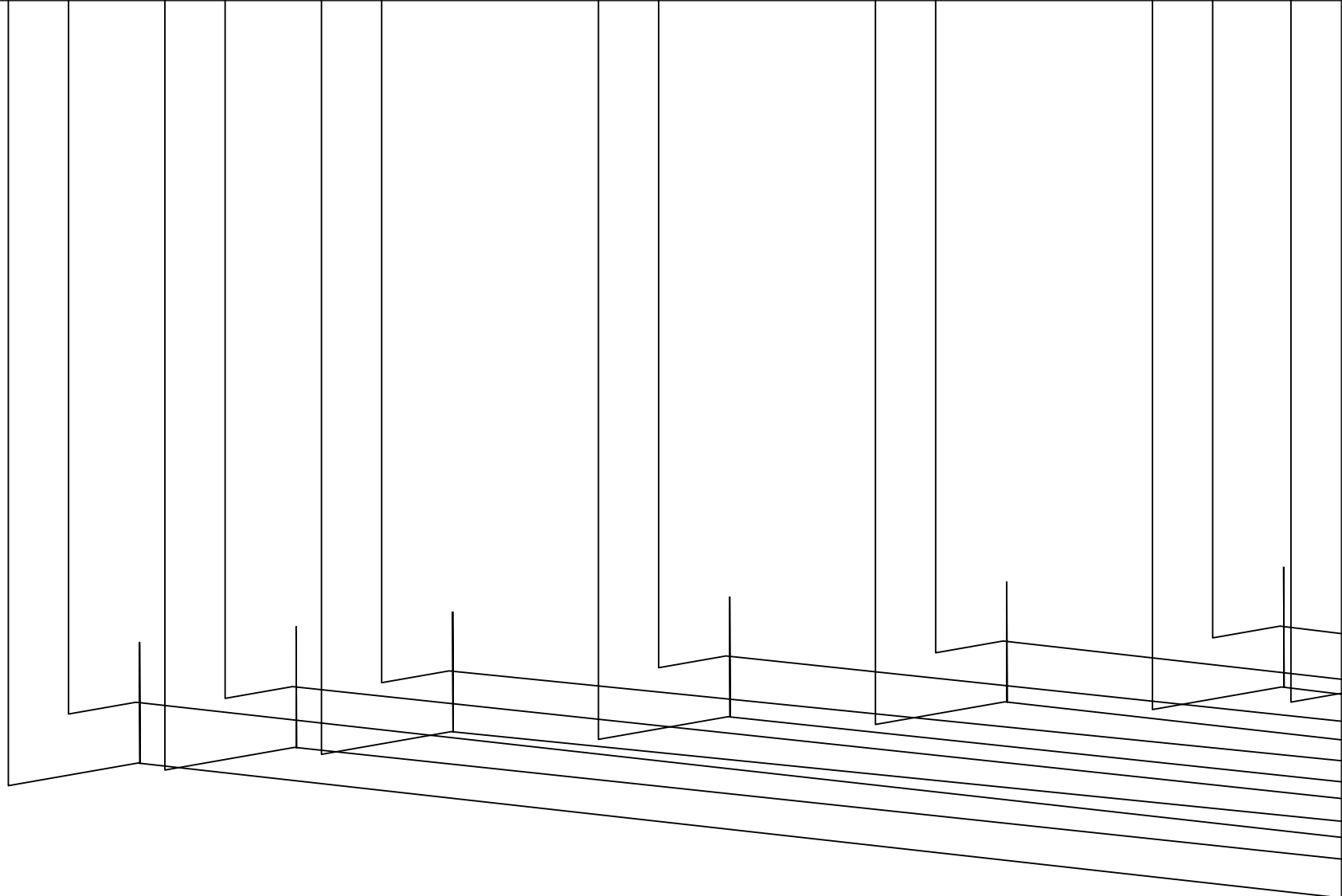

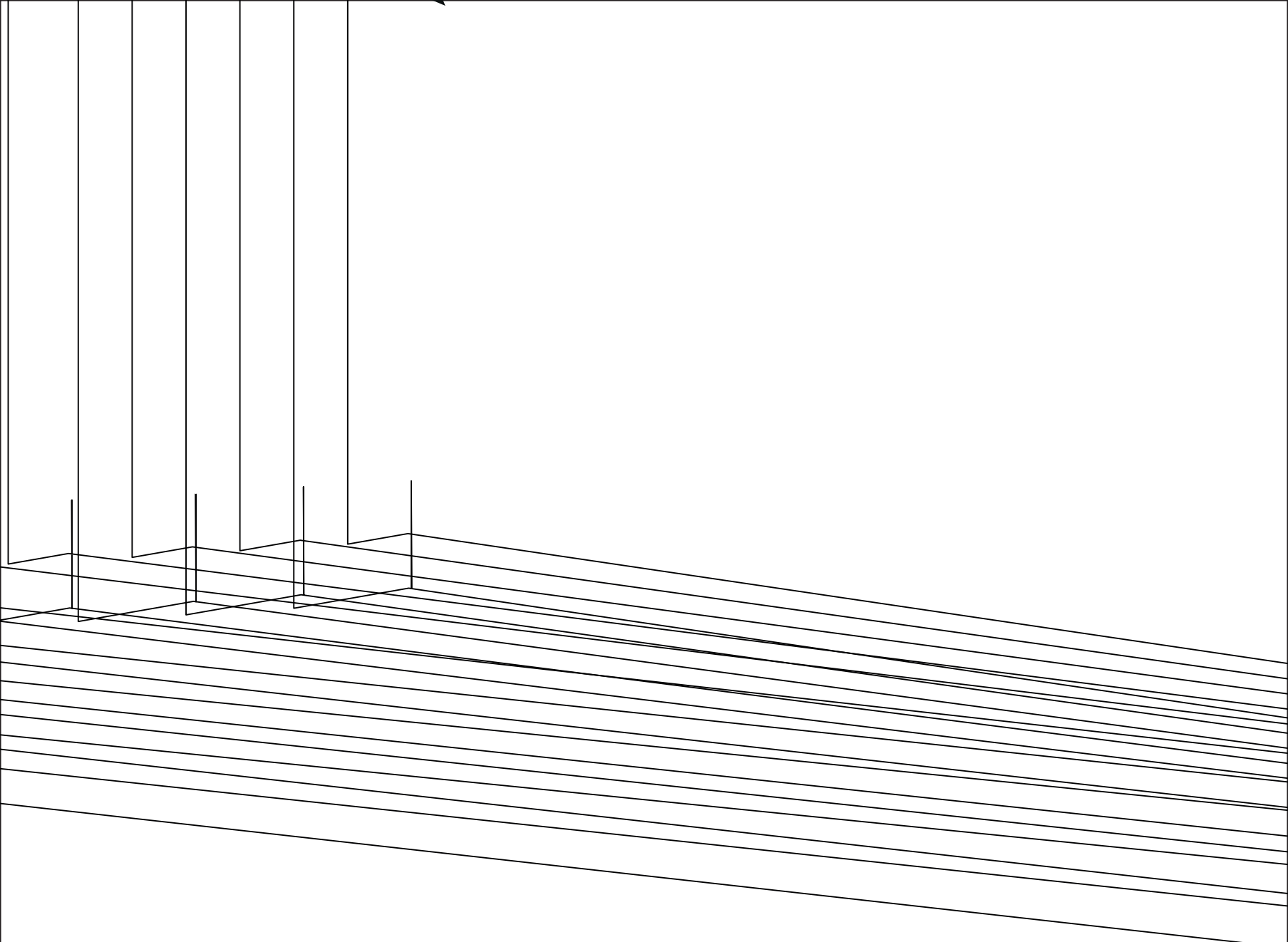

C

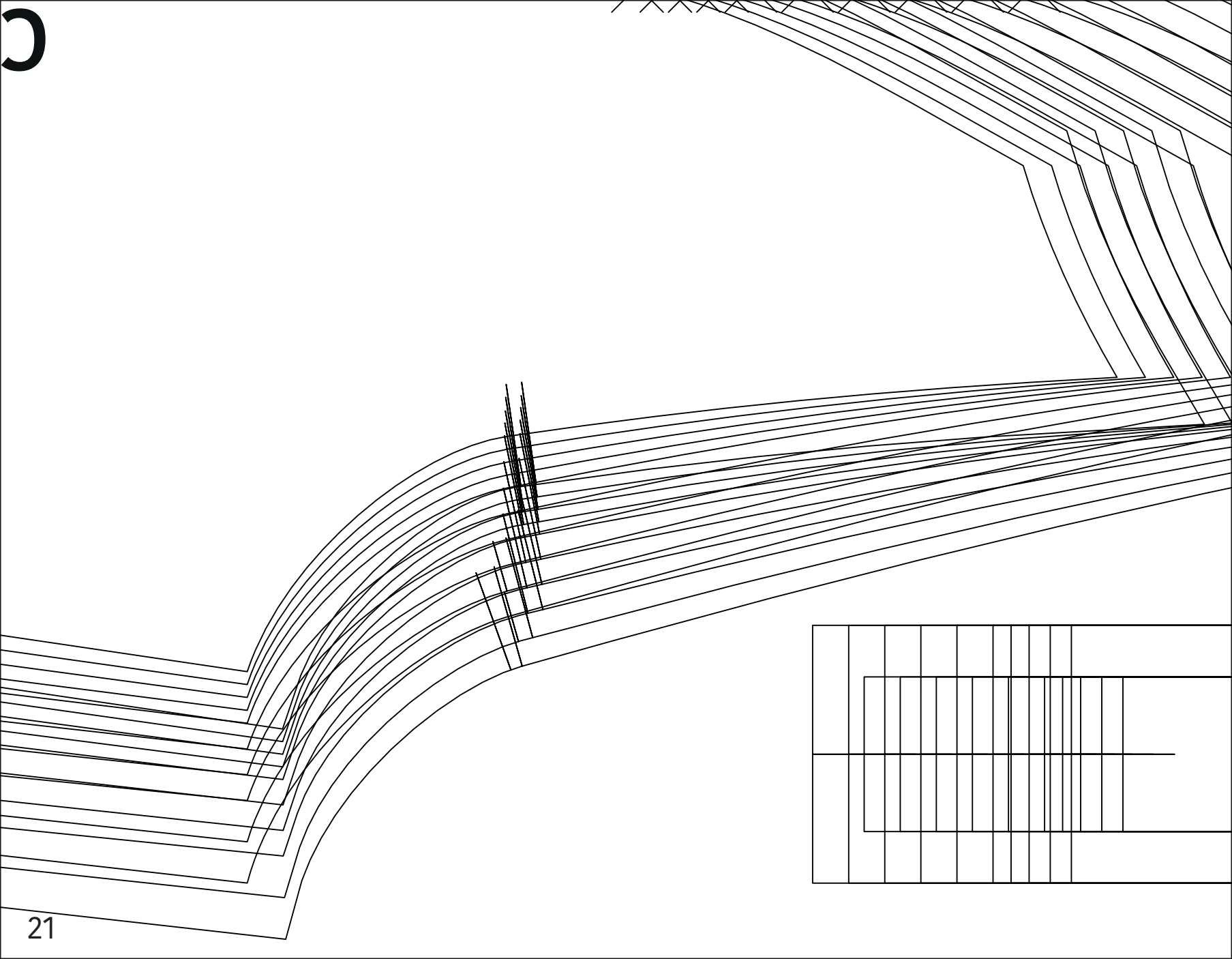

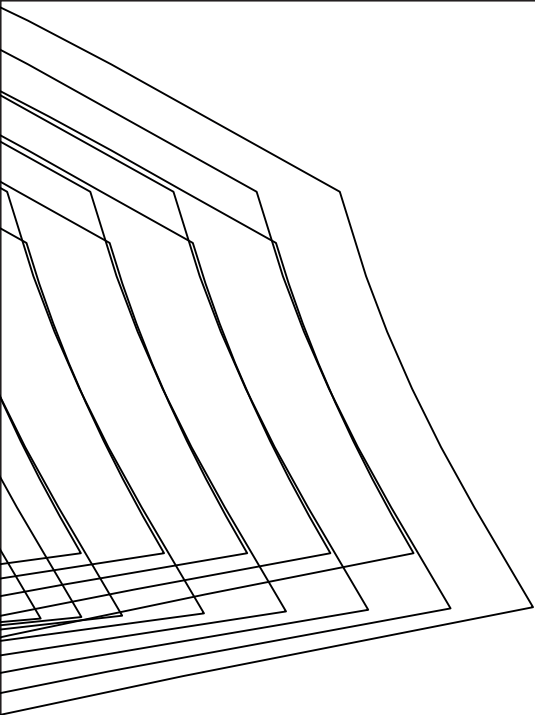

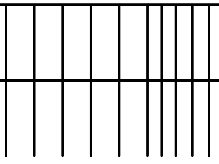
	<p>MV/MDV/CF/VM</p> 