

Patroonschema / Schéma du Patron / Pattern Diagram /
Übersichtsplan zum Zusammenkleben

1	2	3	4	5	6
7	8	9	10	11	12
13	14	15	16	17	18
19	20	21			

Rumer

Top

Patroondelen / Pièces du patron / Pattern pieces / Schnittteile:

- A** voorpand / devant / front panel /
Vorderteil
- B** rugpand / dos / back panel /
Rückenteil
- C** mouw / manche / sleeve / Ärmel
- D** mouw onderkant / bas de manche /
sleeve bottom panel /
Ärmel unterer Rand
- E** biaislint halsuitsnijding / ruban en
biais encolure / bias tape neckline
Paspelband Halsausschnitt

Controlevierkant / Carré de controle
/ Test square / Kontrollquadrat

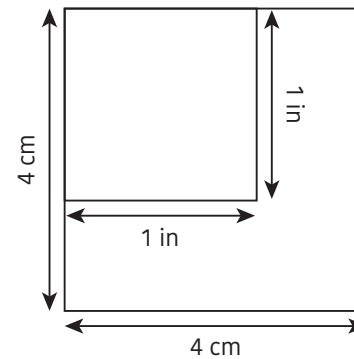

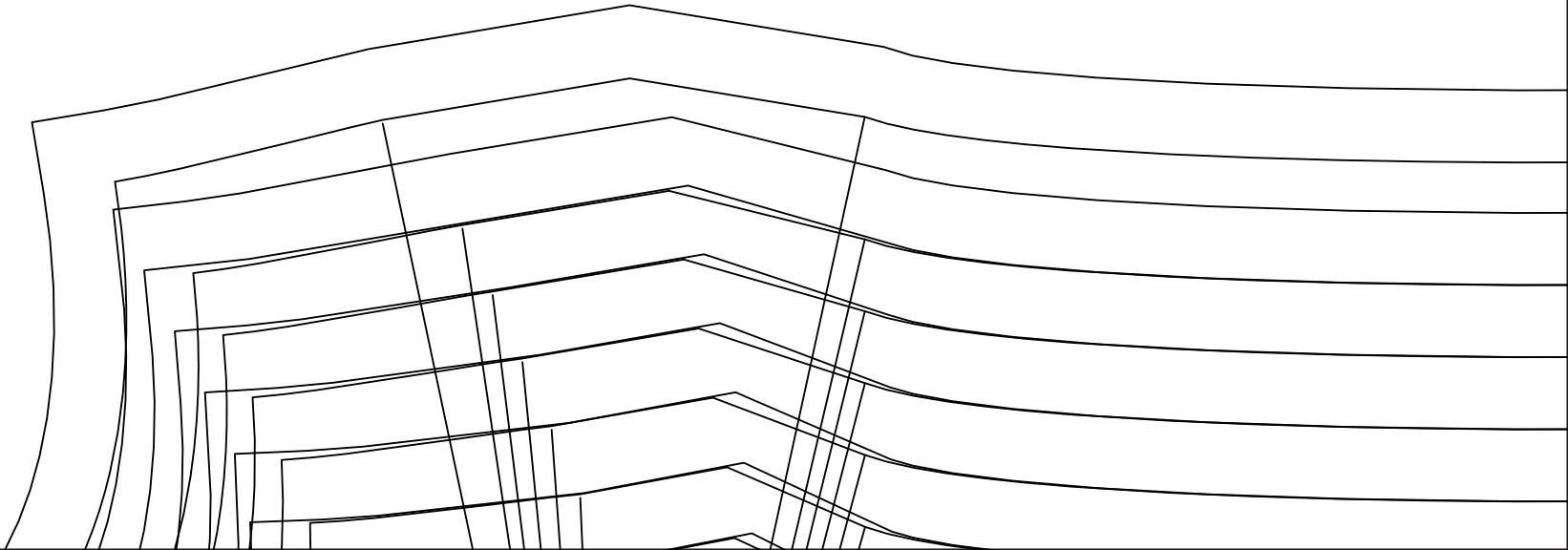
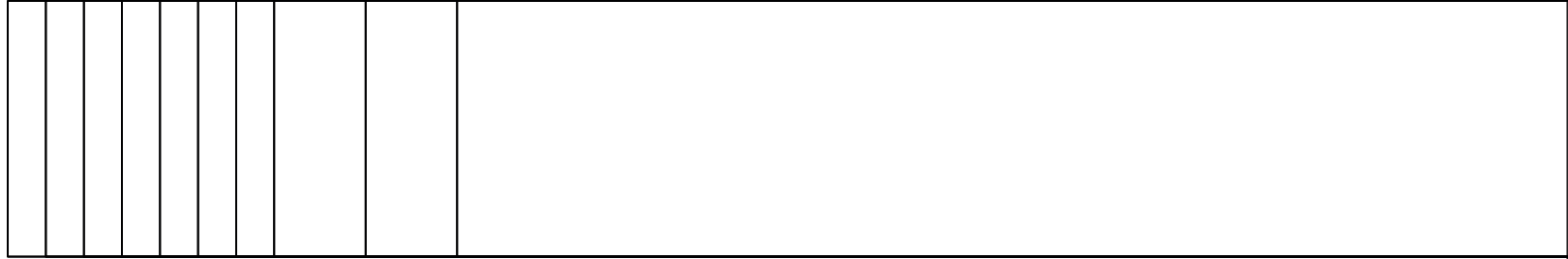

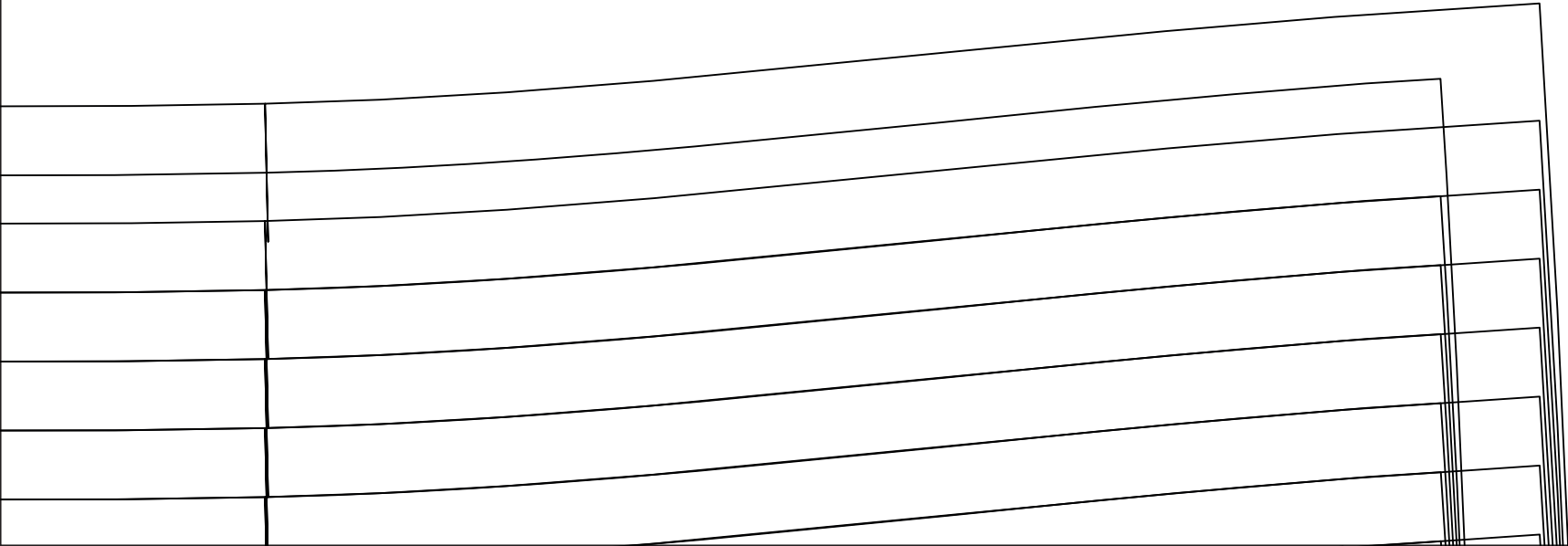
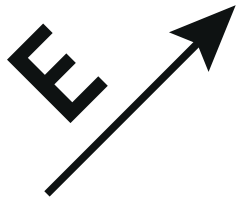

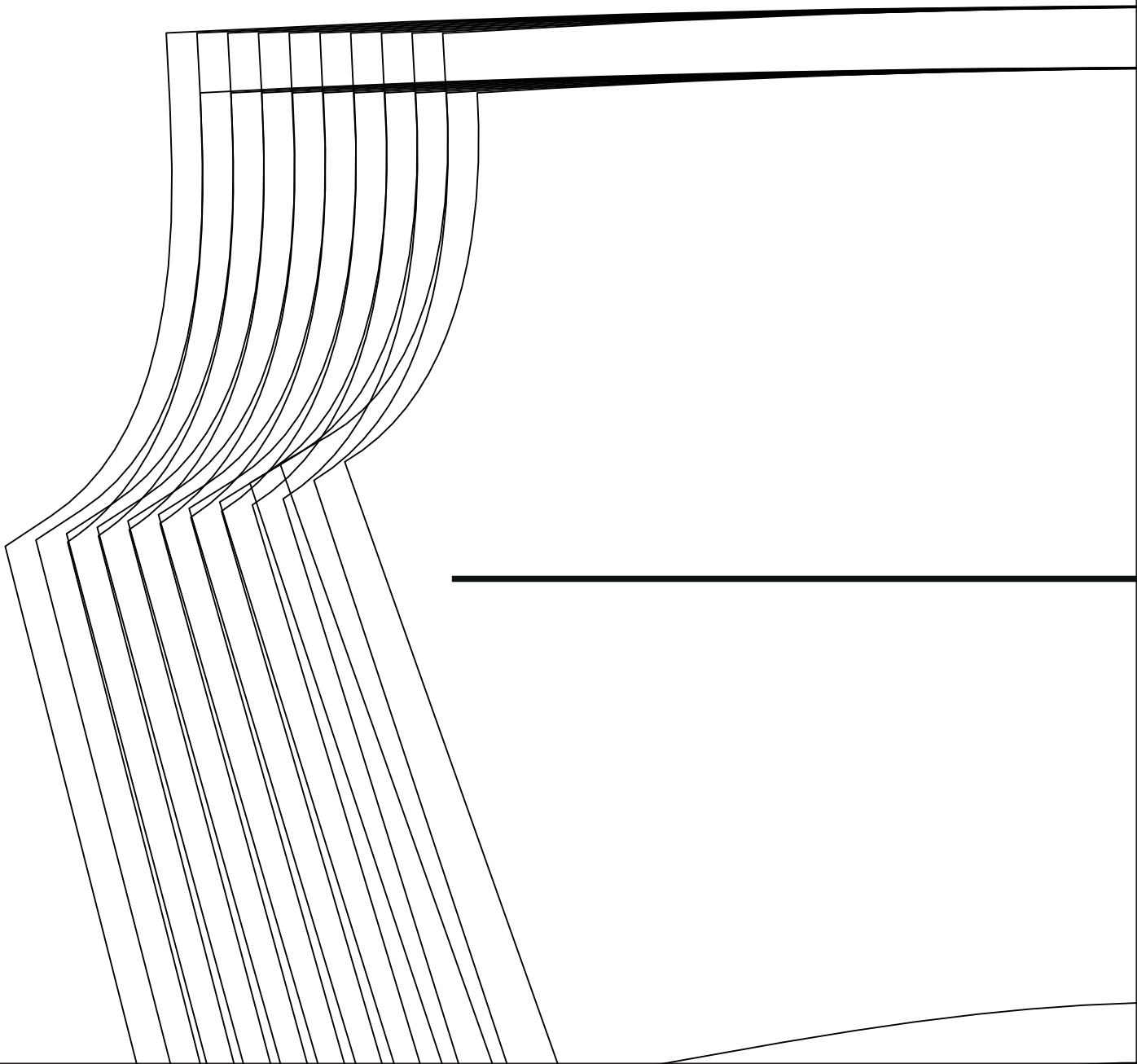

B

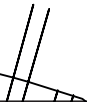

6

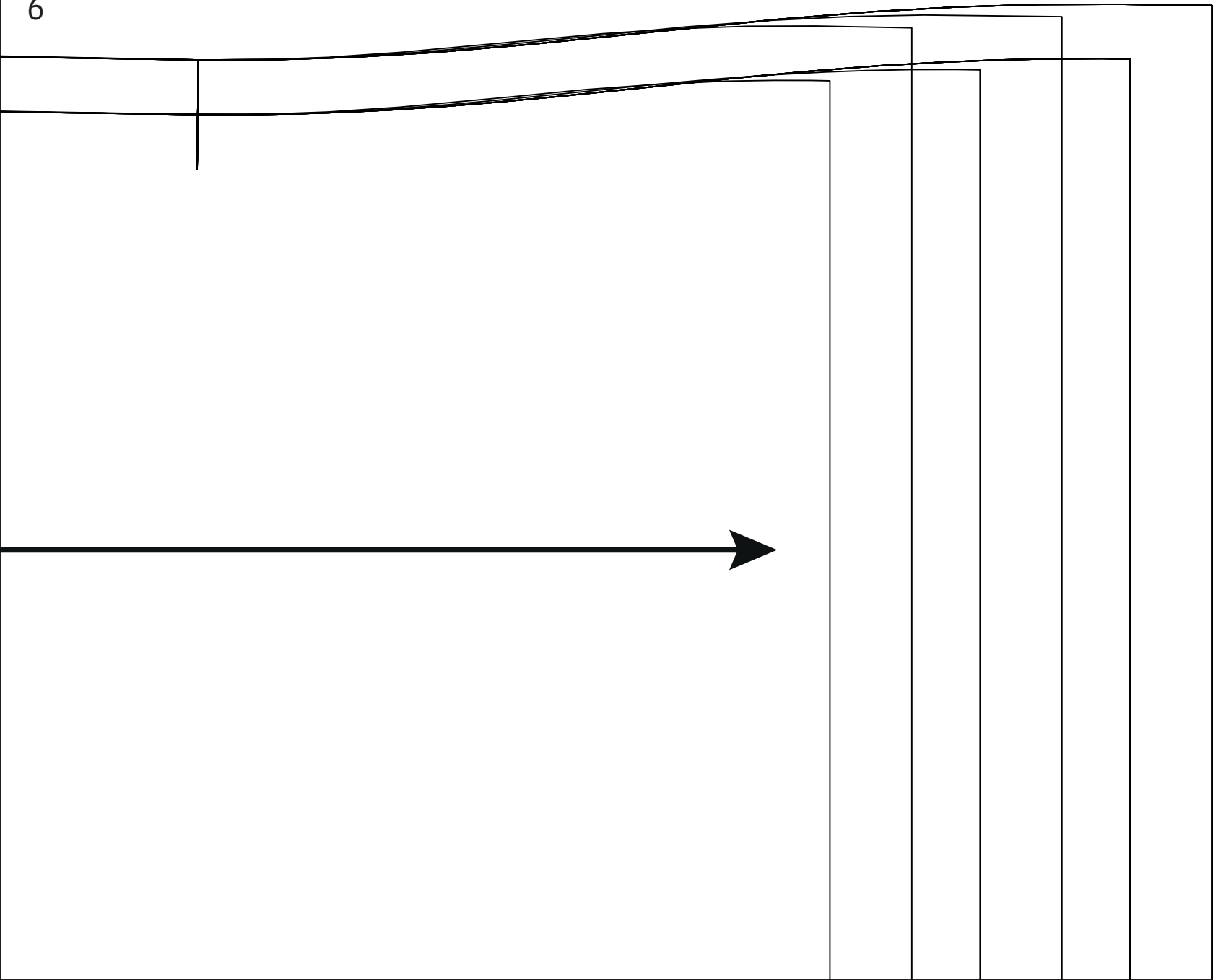

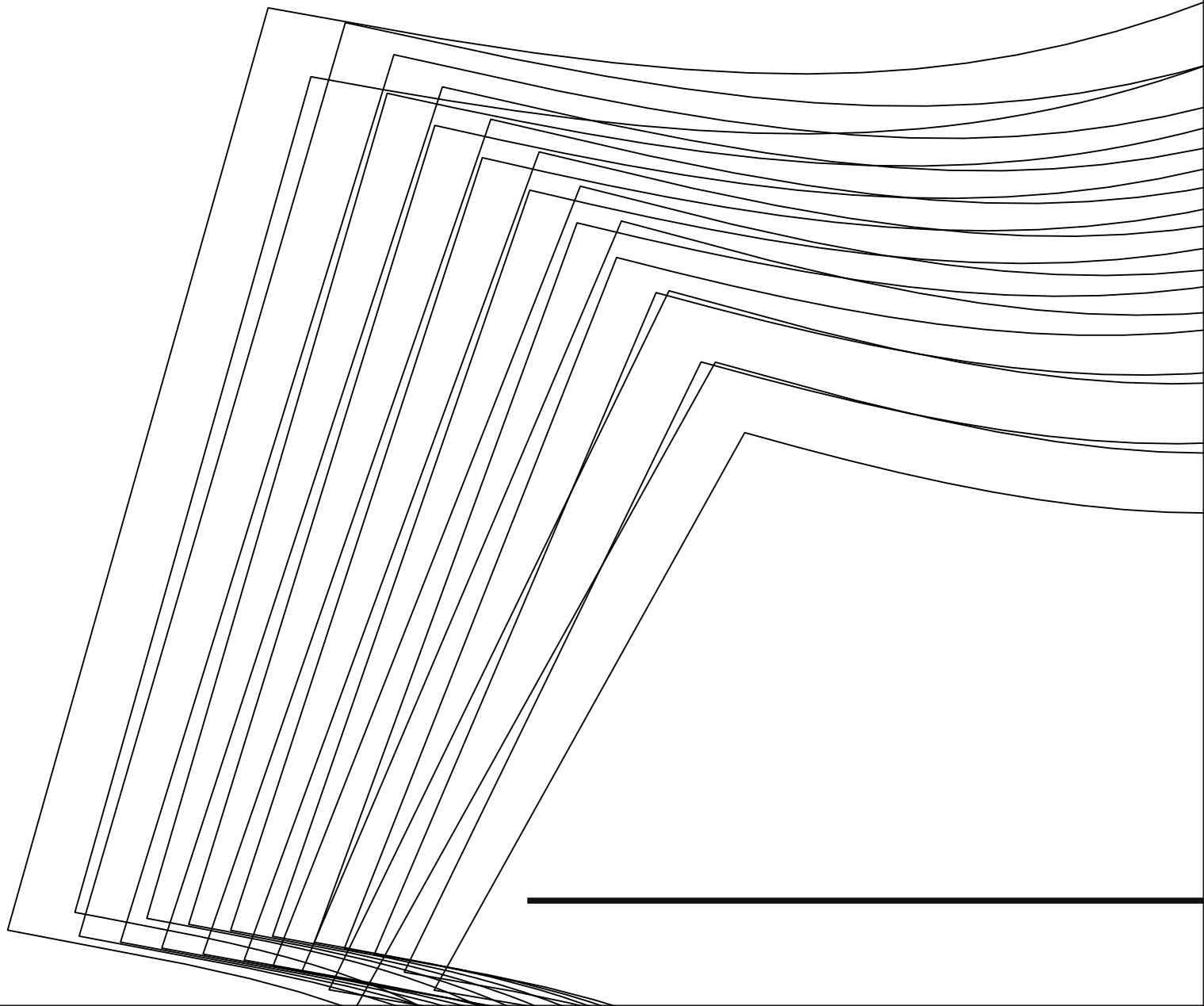

8

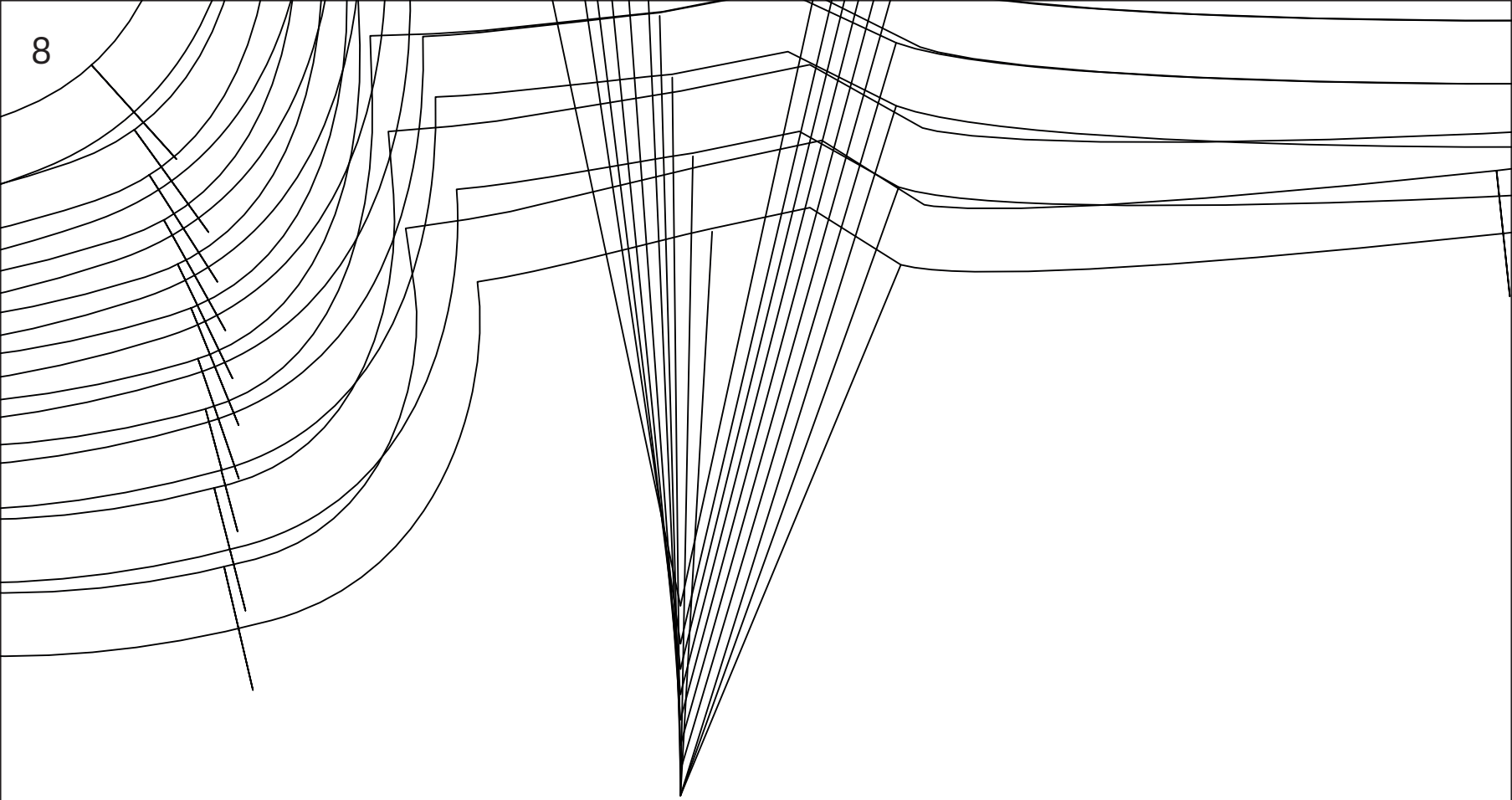

A

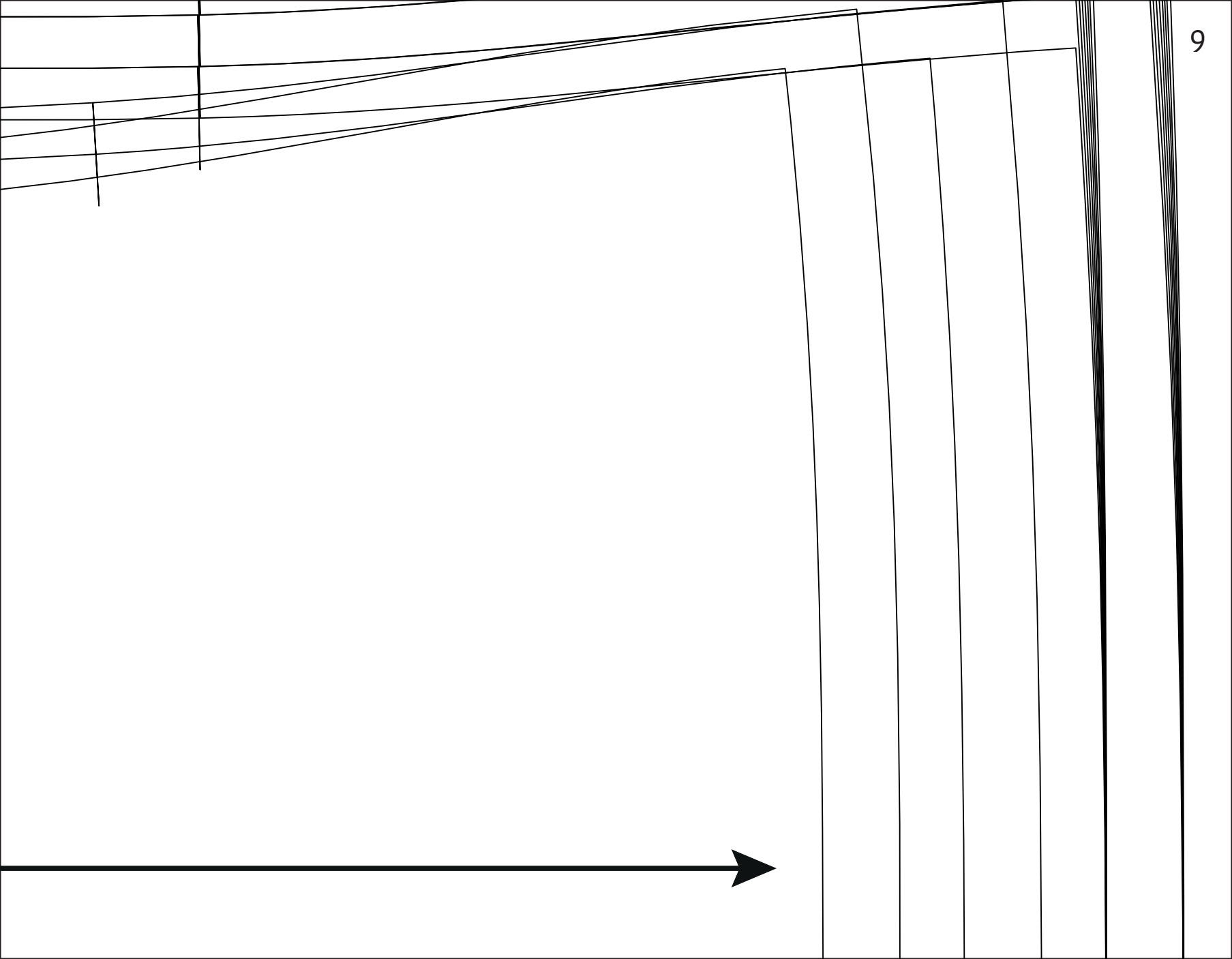

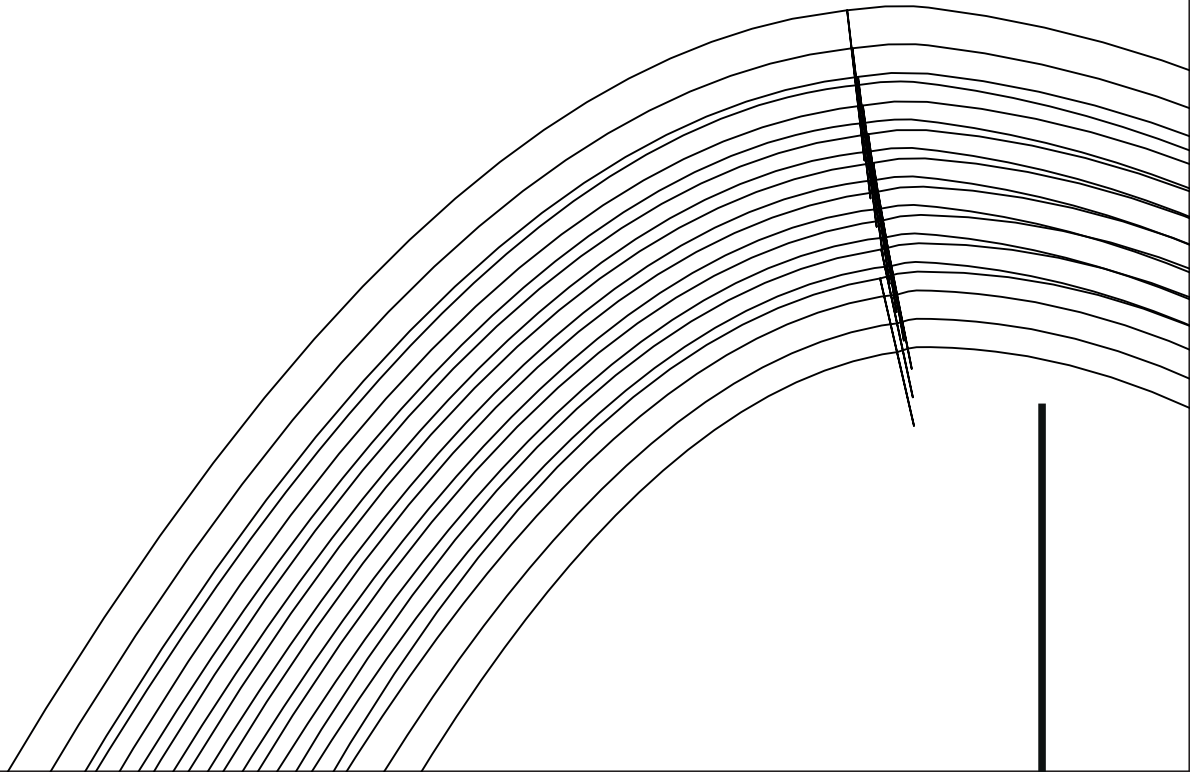
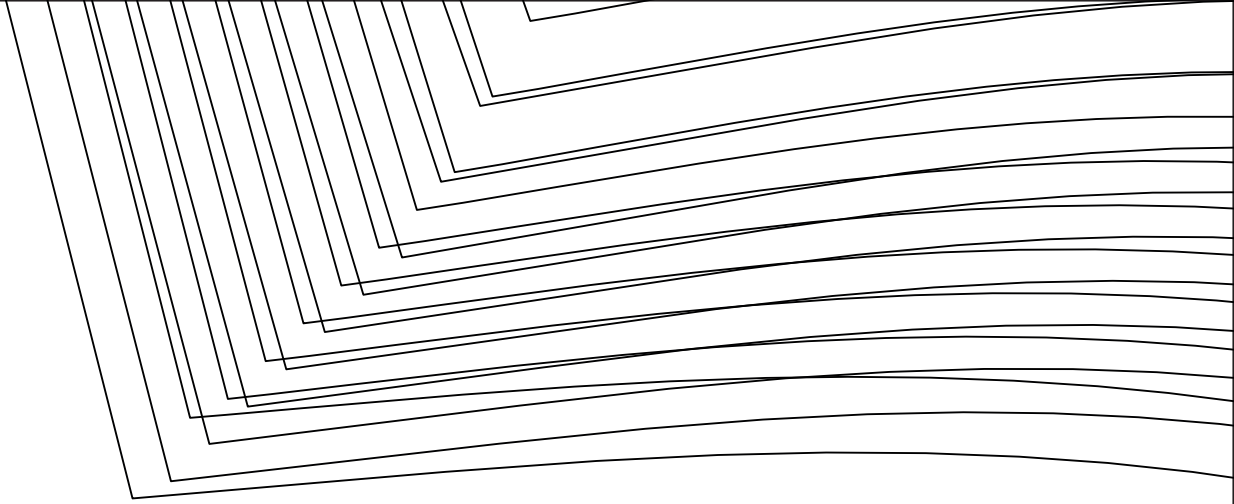

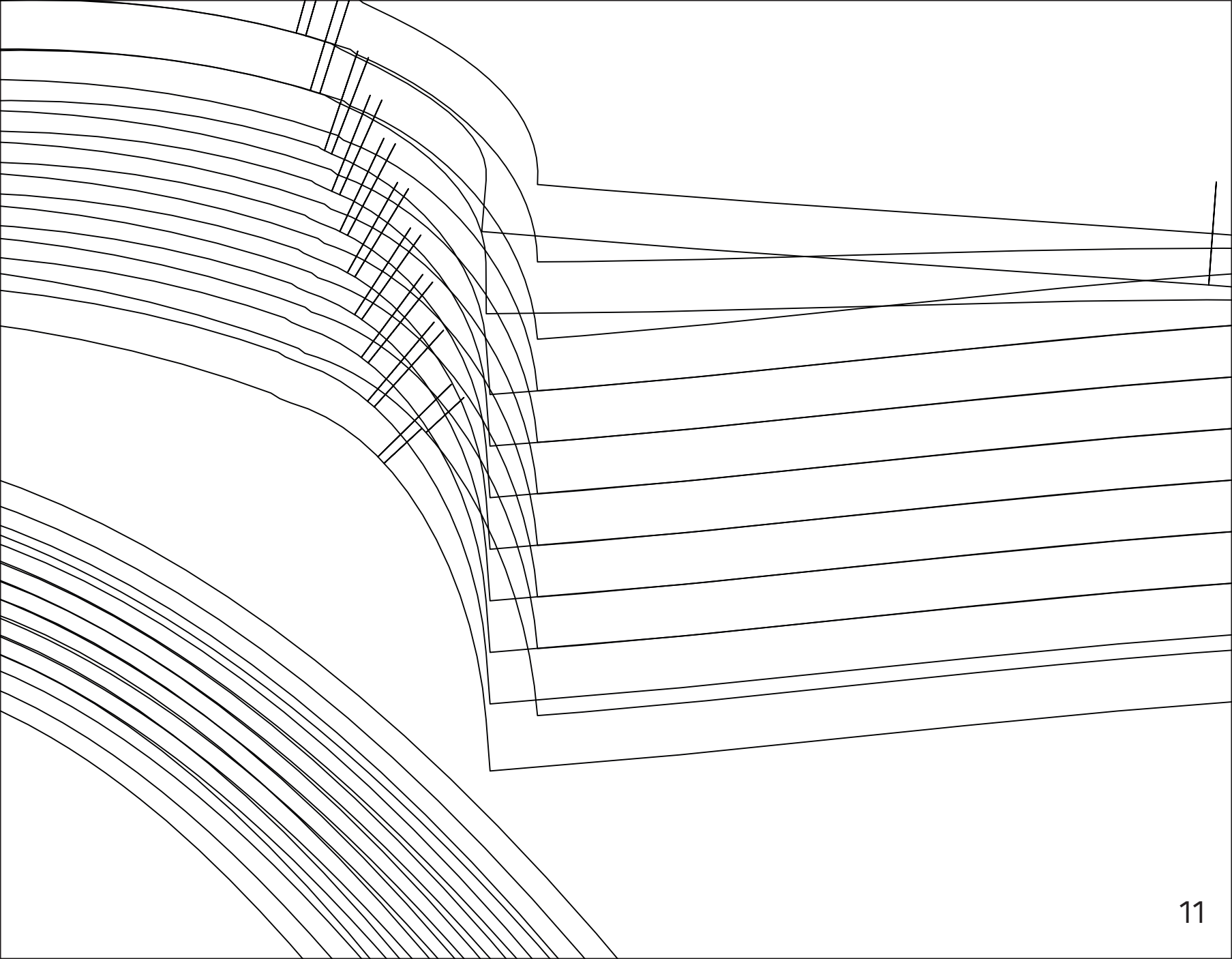

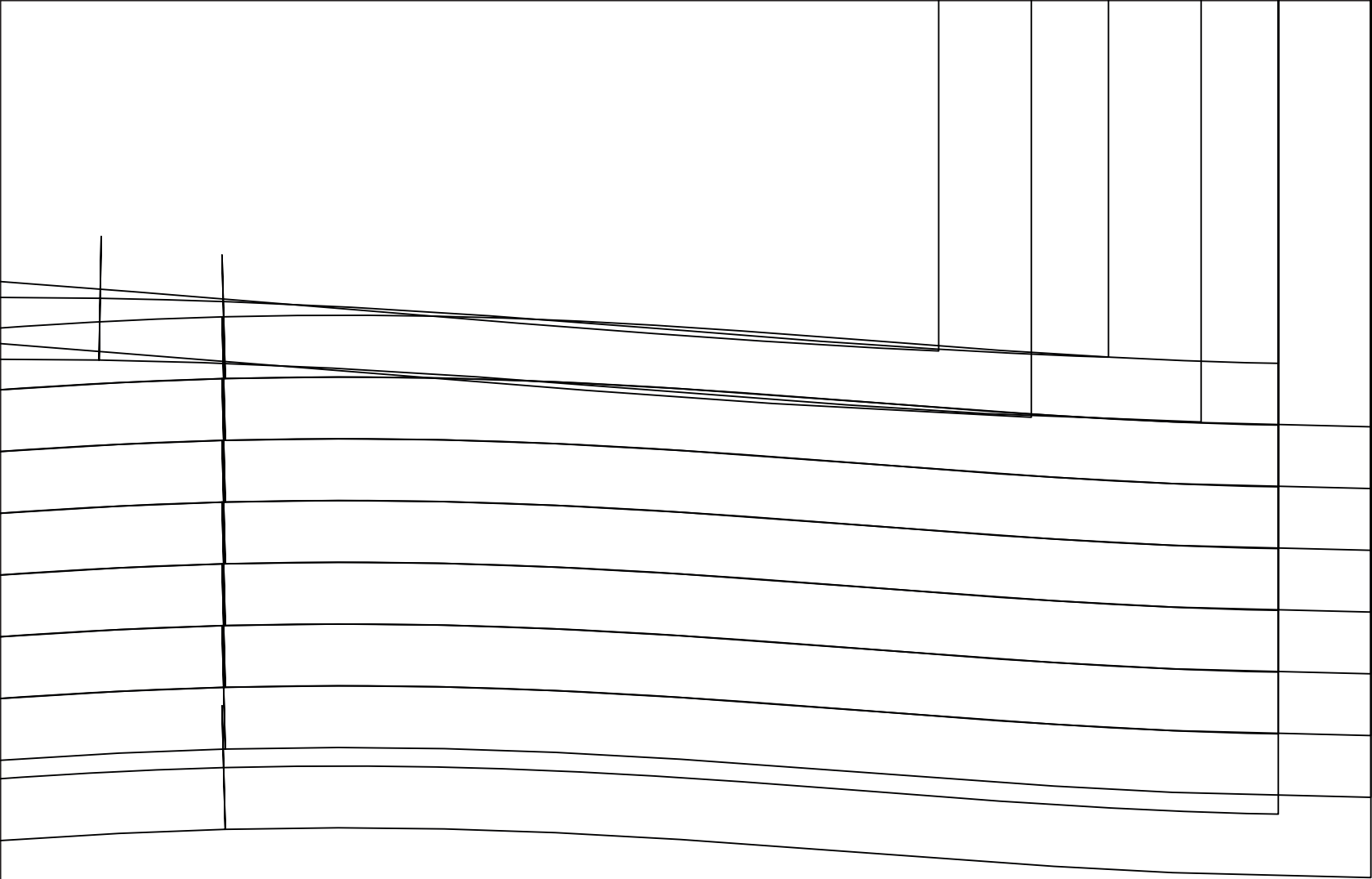

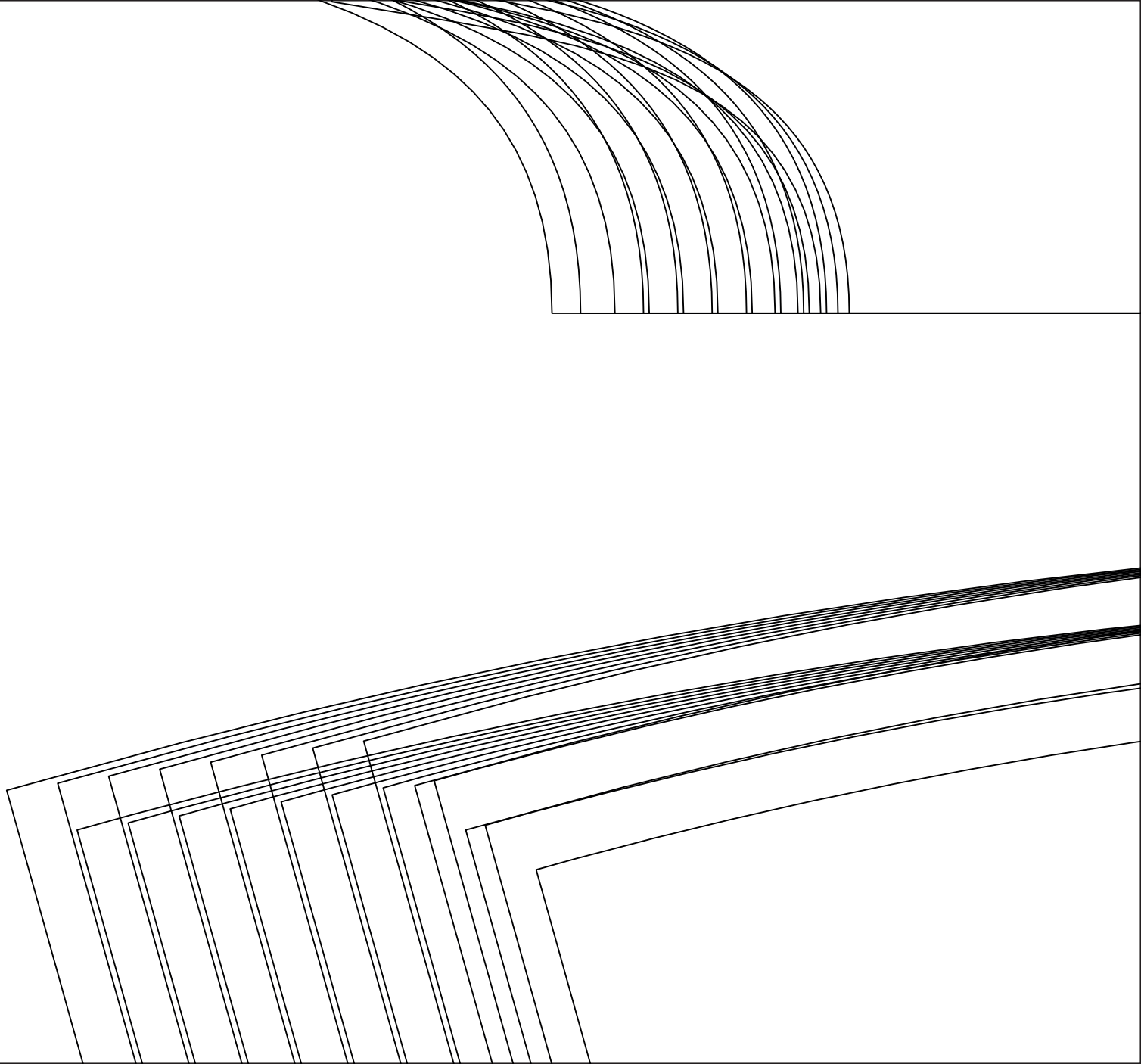

MV/MDV/CF/VM

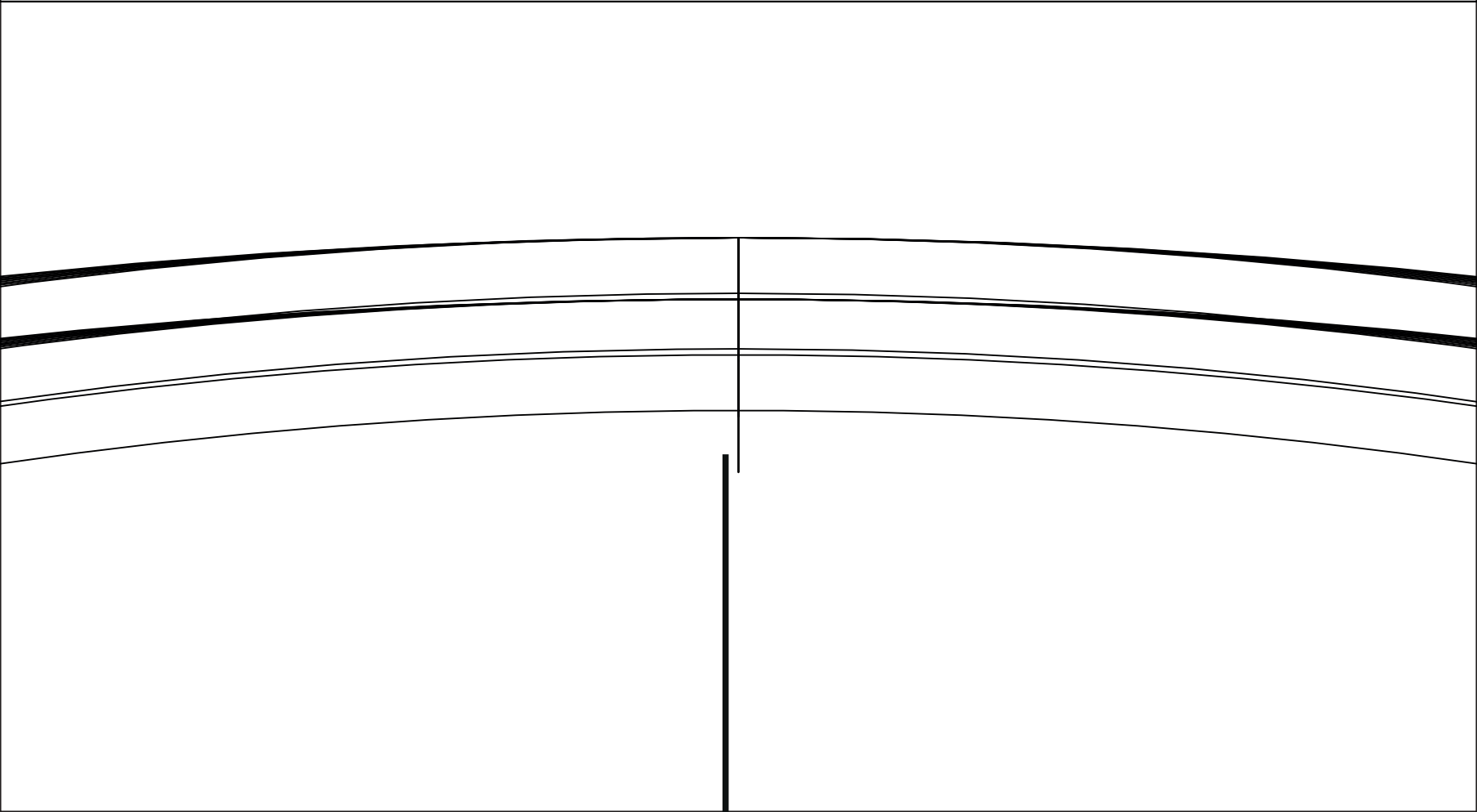

--	--	--	--	--	--

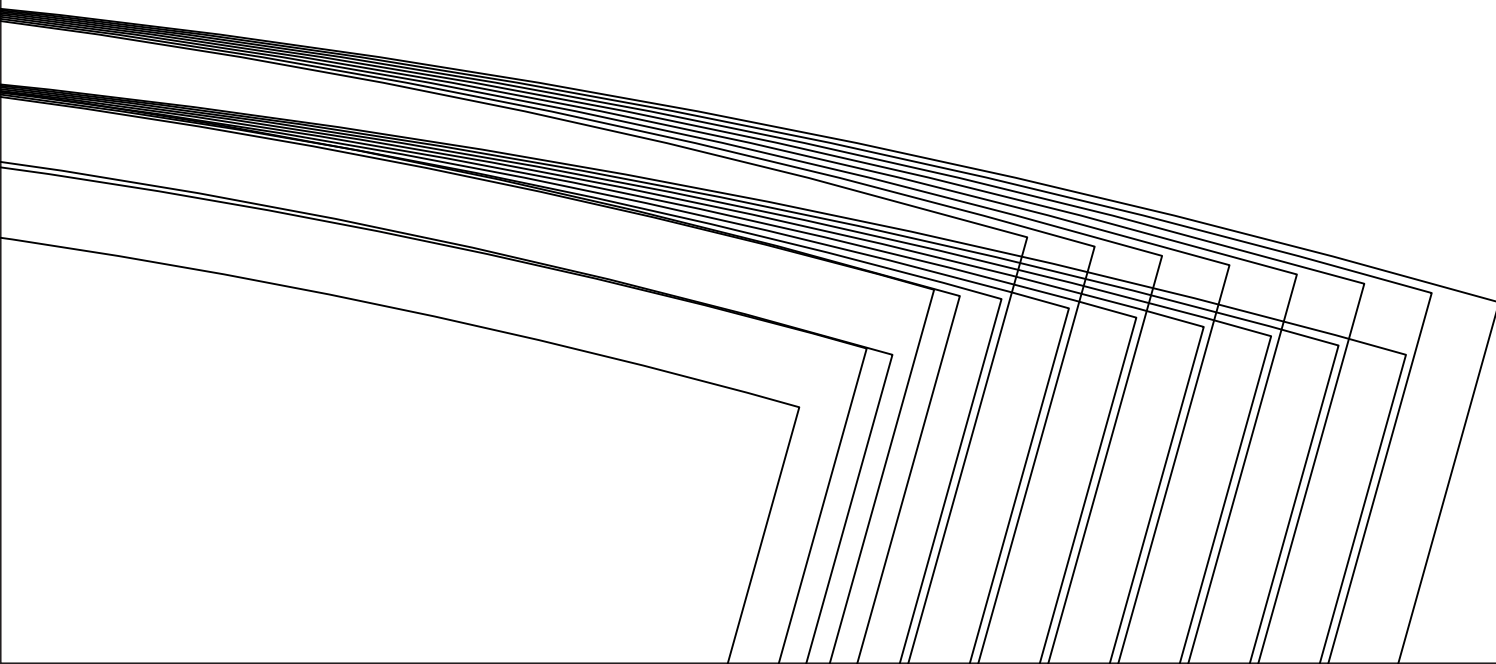

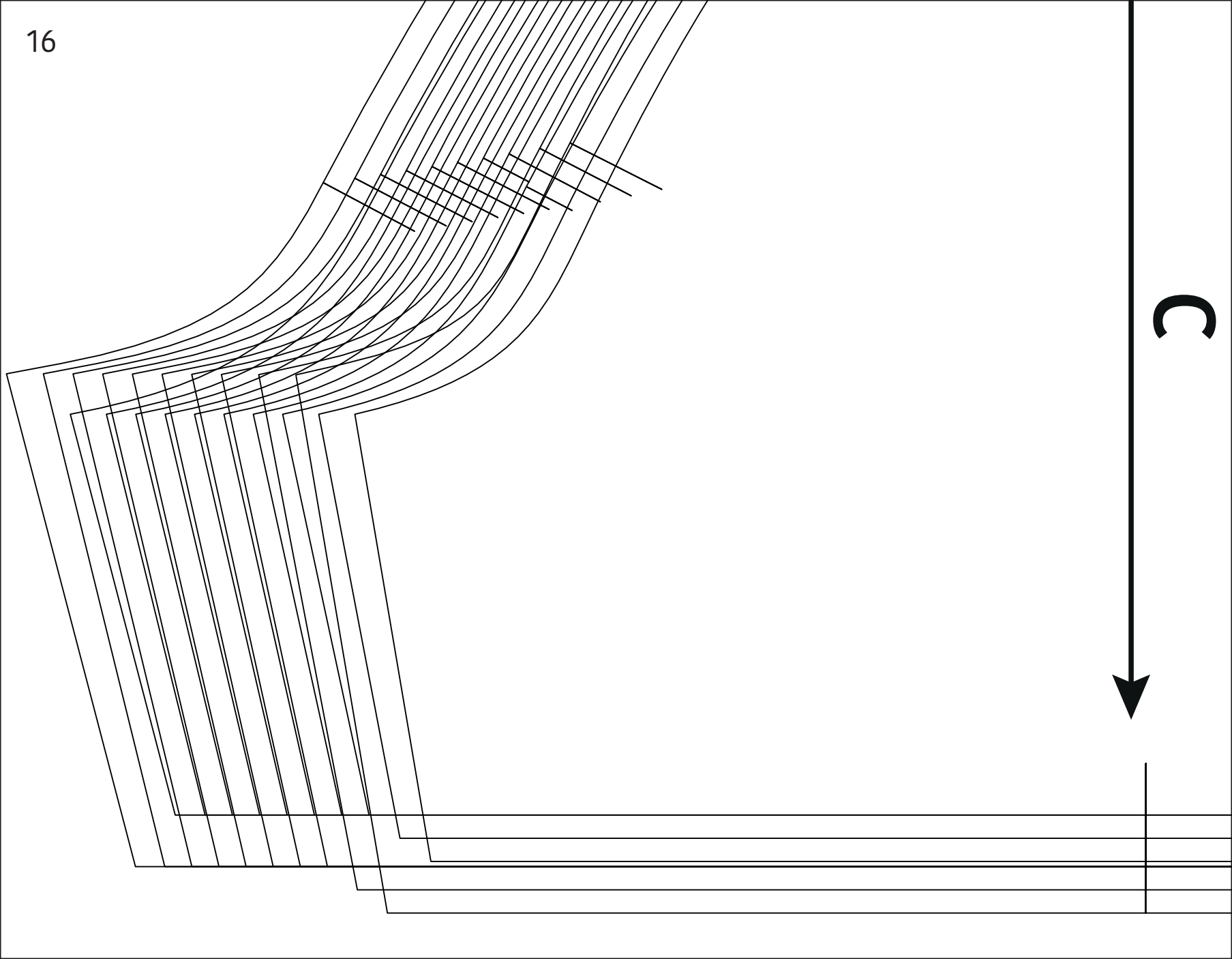

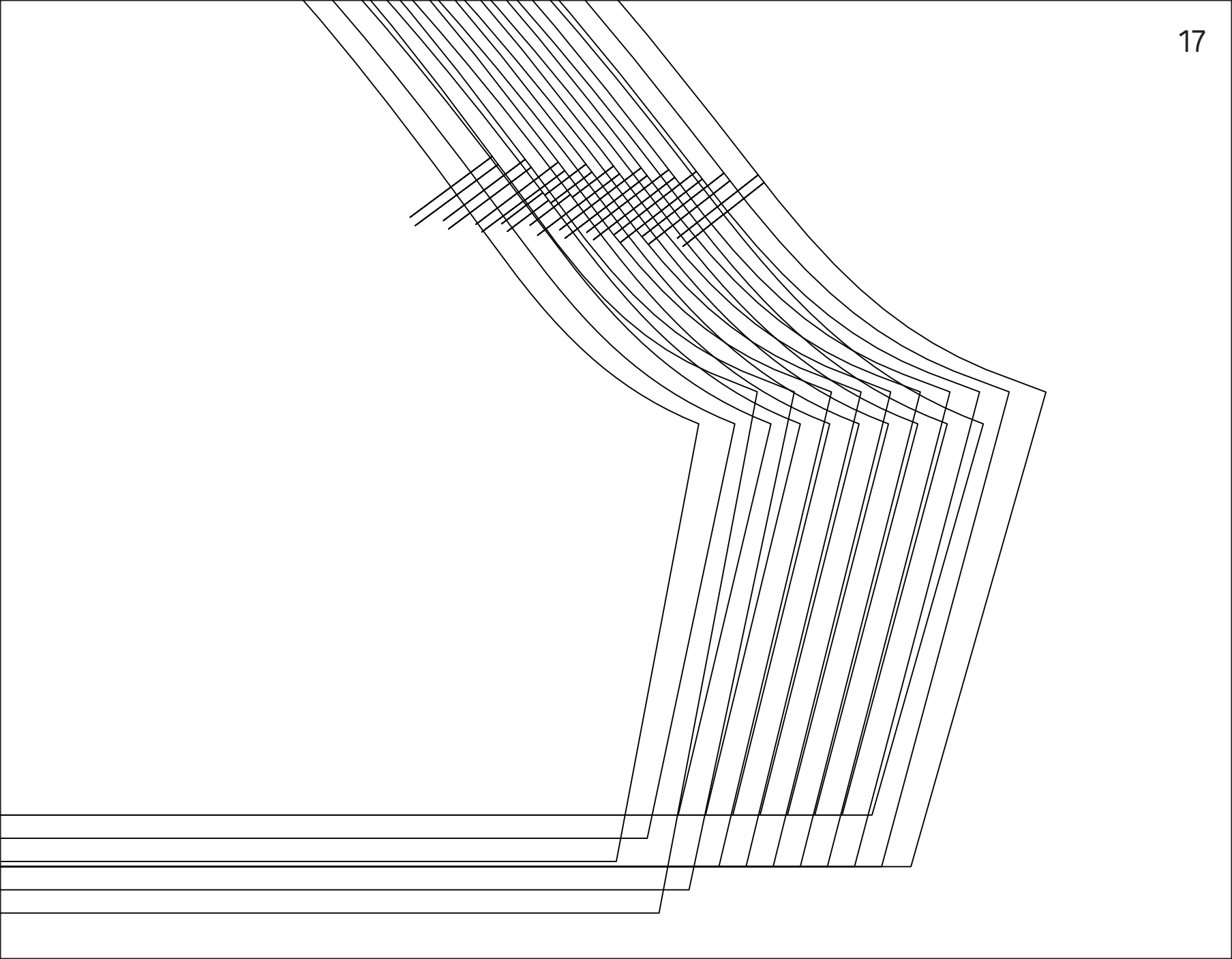

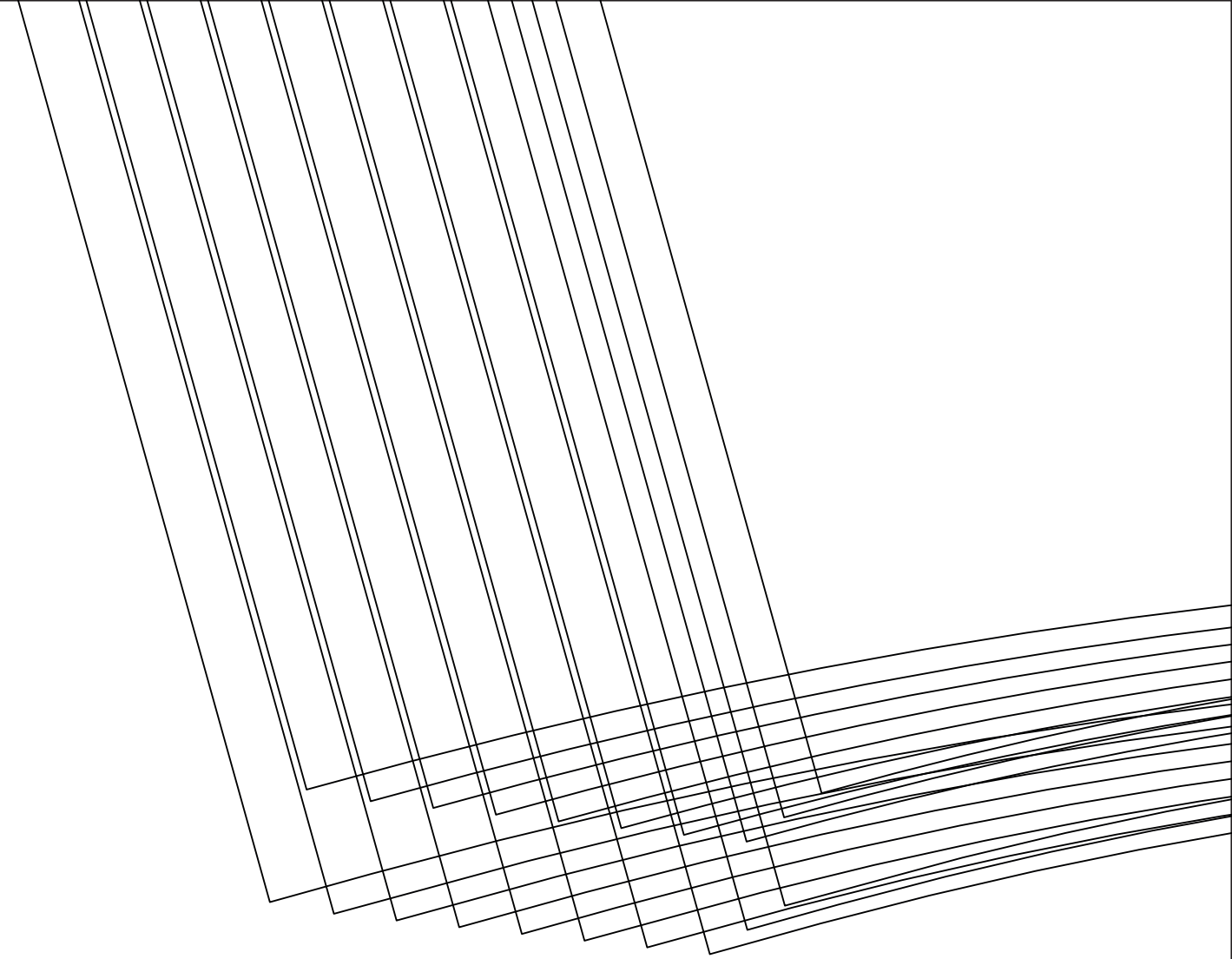

D

