

Maud

Jurk / Robe /
Dress / Kleid

Patroondelen / Pièces du patron /
Pattern pieces / Schnittteile:

- A** voorpand / devant / front panel /
Vorderteil
B rugpand / dos / back panel /
Rückenteil
C beleg VP / parementure DV / facing FP /
Besatz VT
D beleg RP / parementure DS / facing BP /
Besatz RT

Patroonschema / Schéma du Patron / Pattern Diagram /
Übersichtsplan zum Zusammenkleben

1	2	3	4	5	6
7	8	9	10	11	12
13	14	15	16	17	18
19	20	21	22	23	24
25	26	27	28	29	30
31	32	33			

Controlevierkant / Carré de controle
/ Test square / Kontrollquadrat

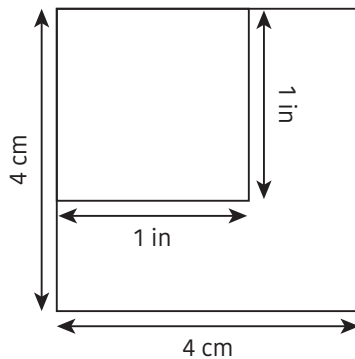

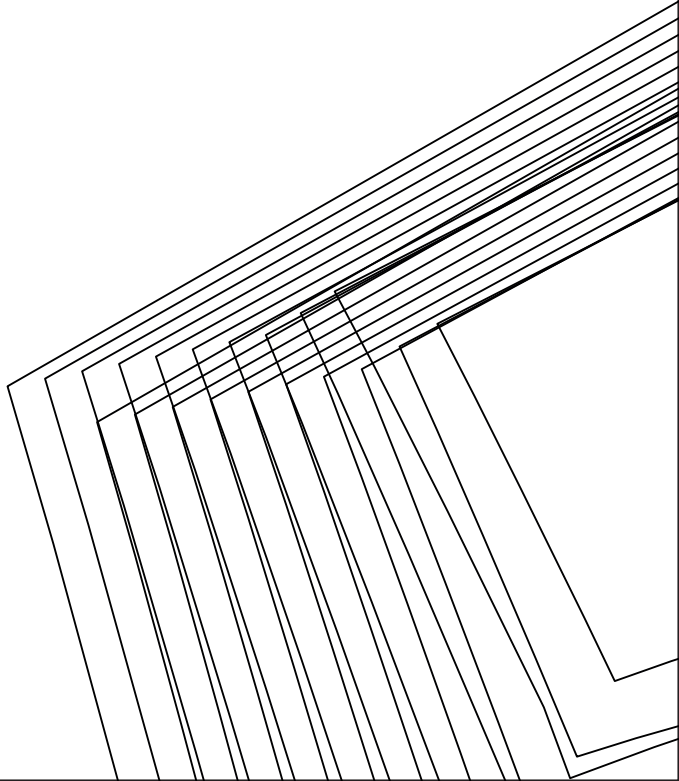

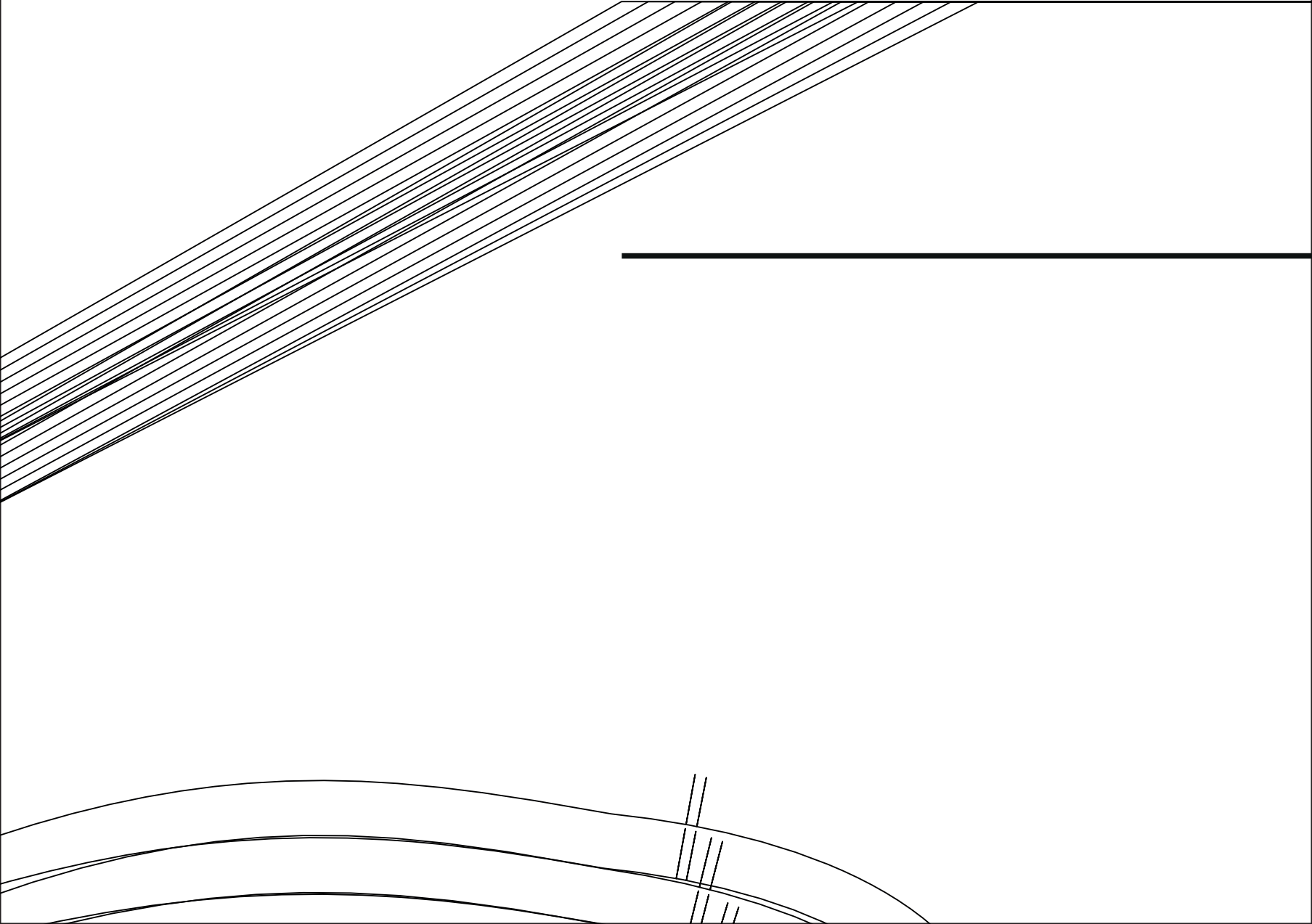

MR/MDS/CB/RM



B

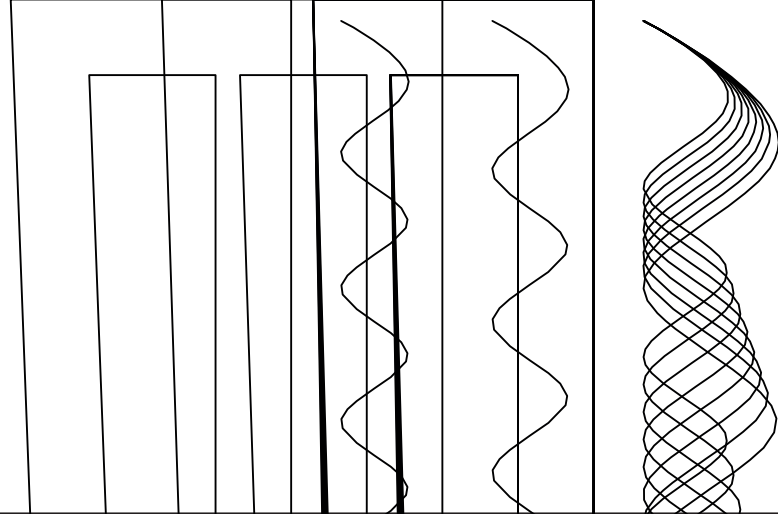



--	--	--	--	--	--	--	--	--

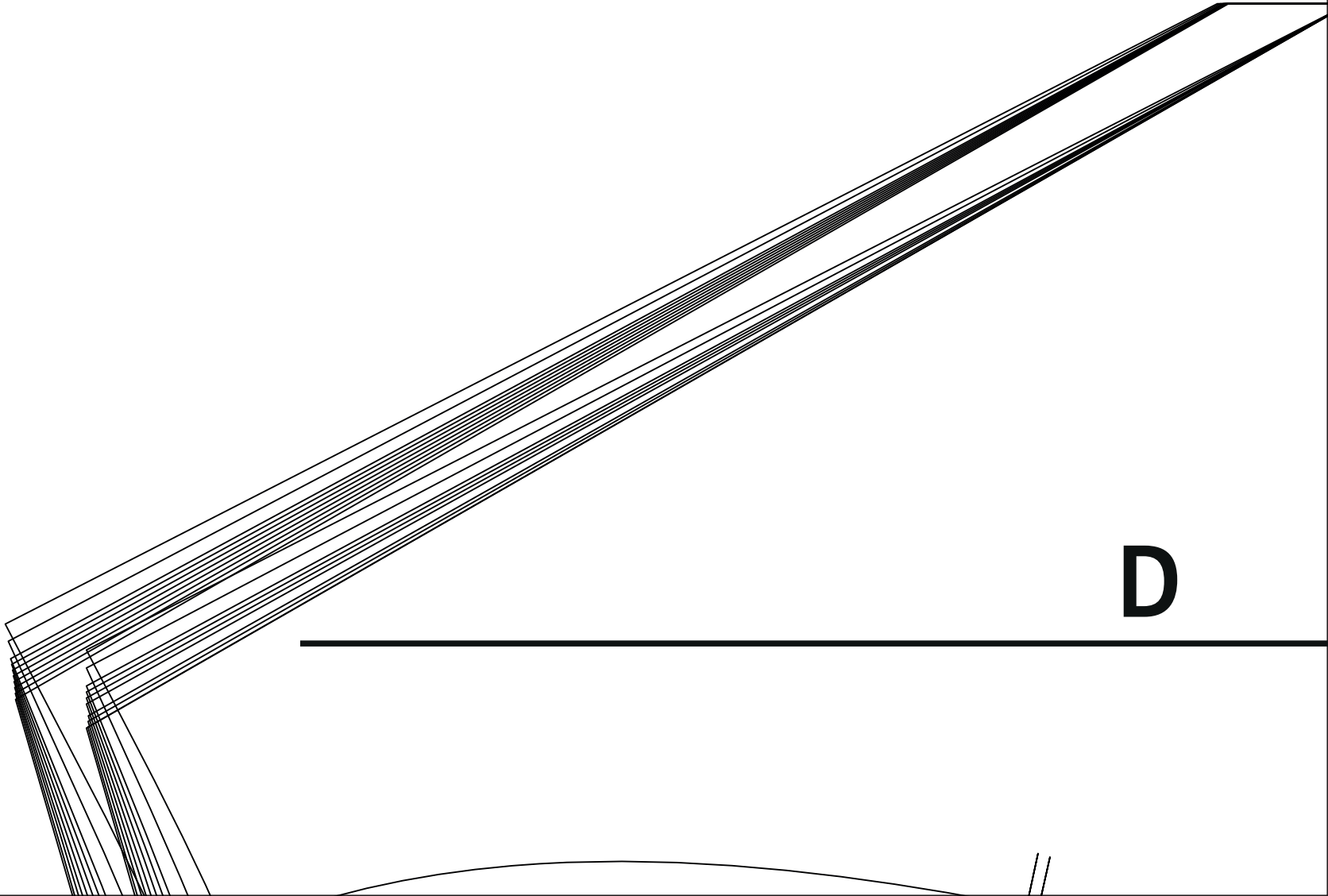

MR/MDS/CB/RM

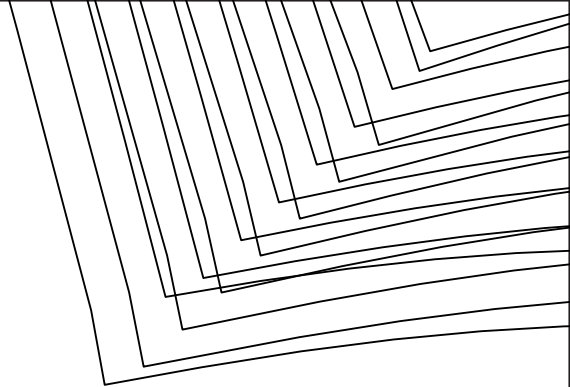
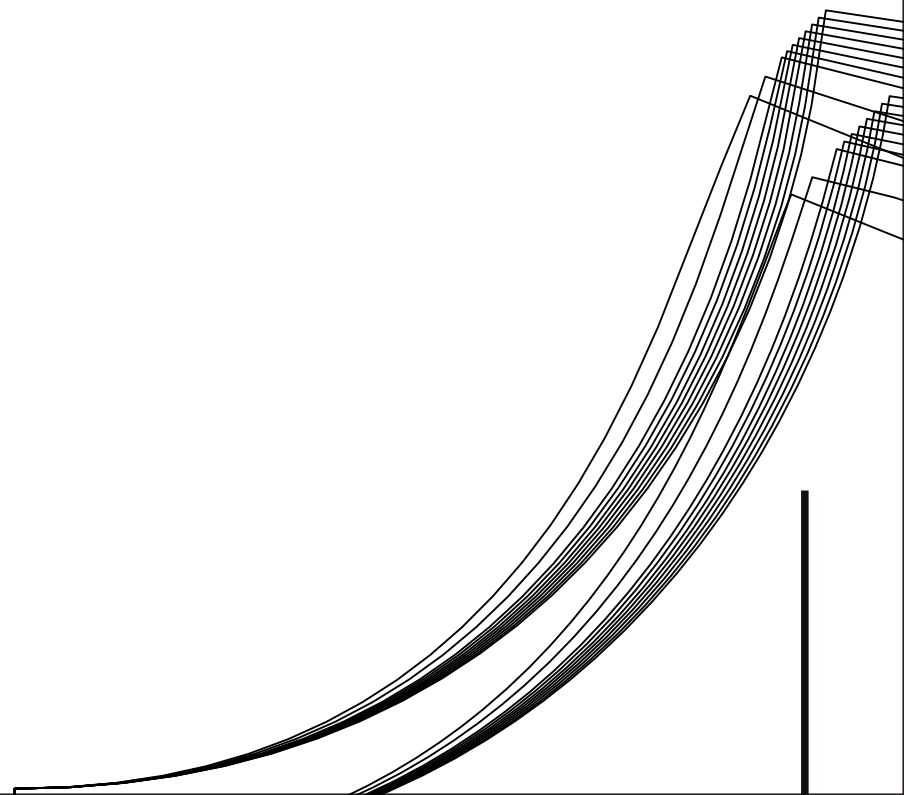
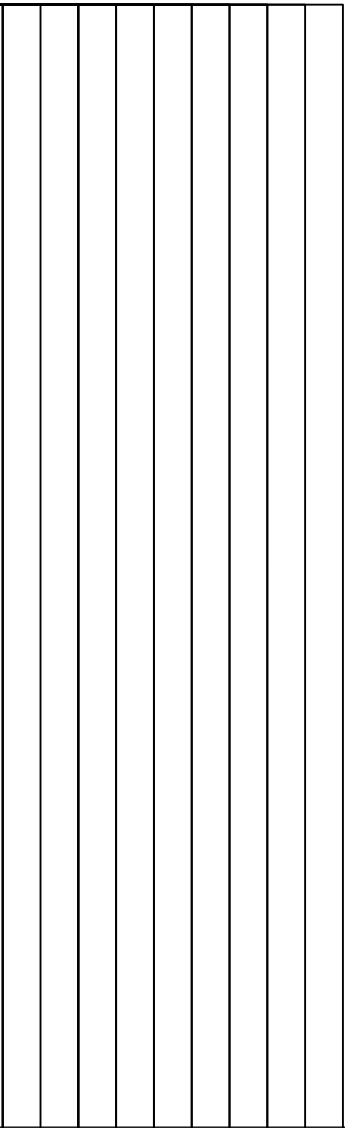

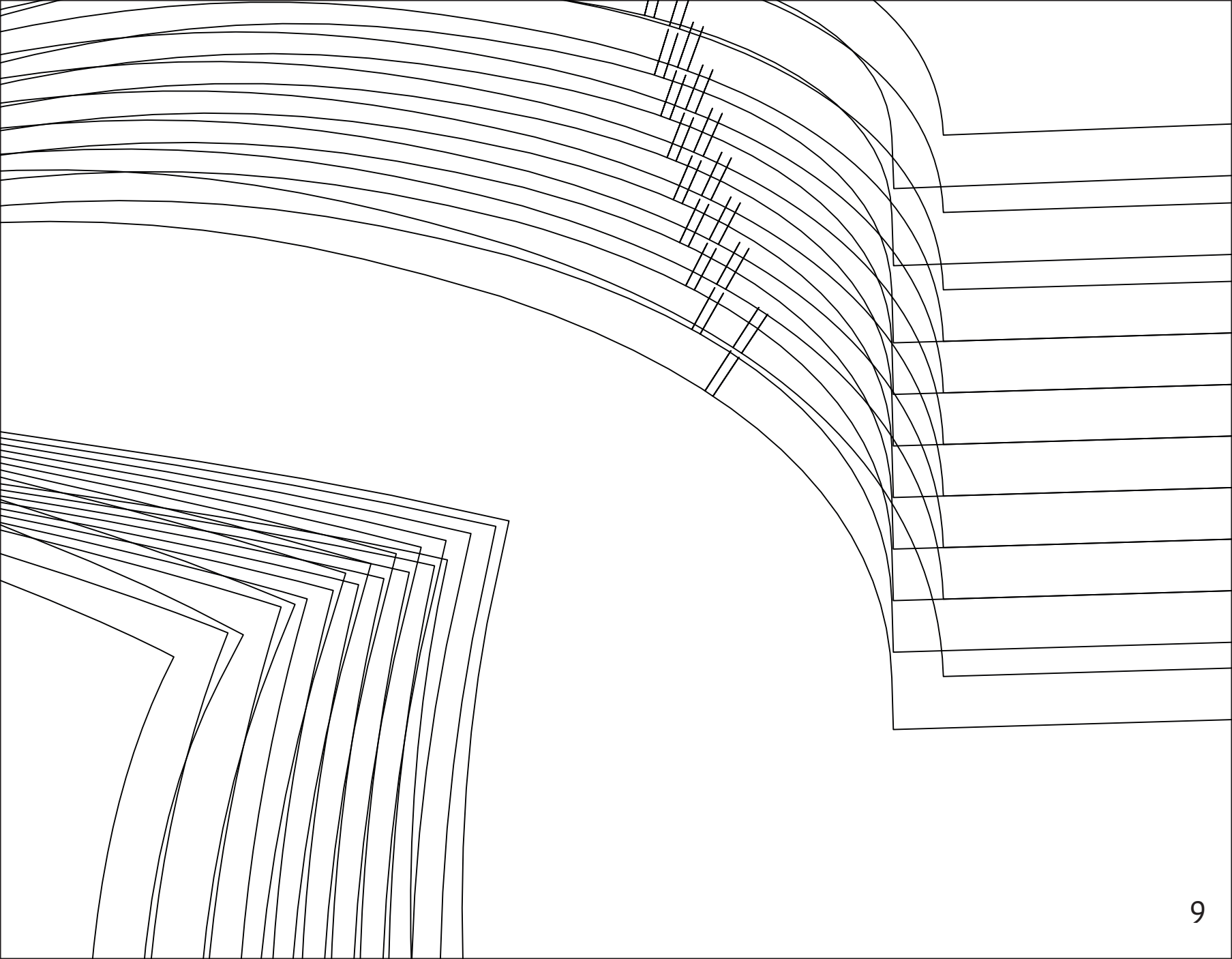

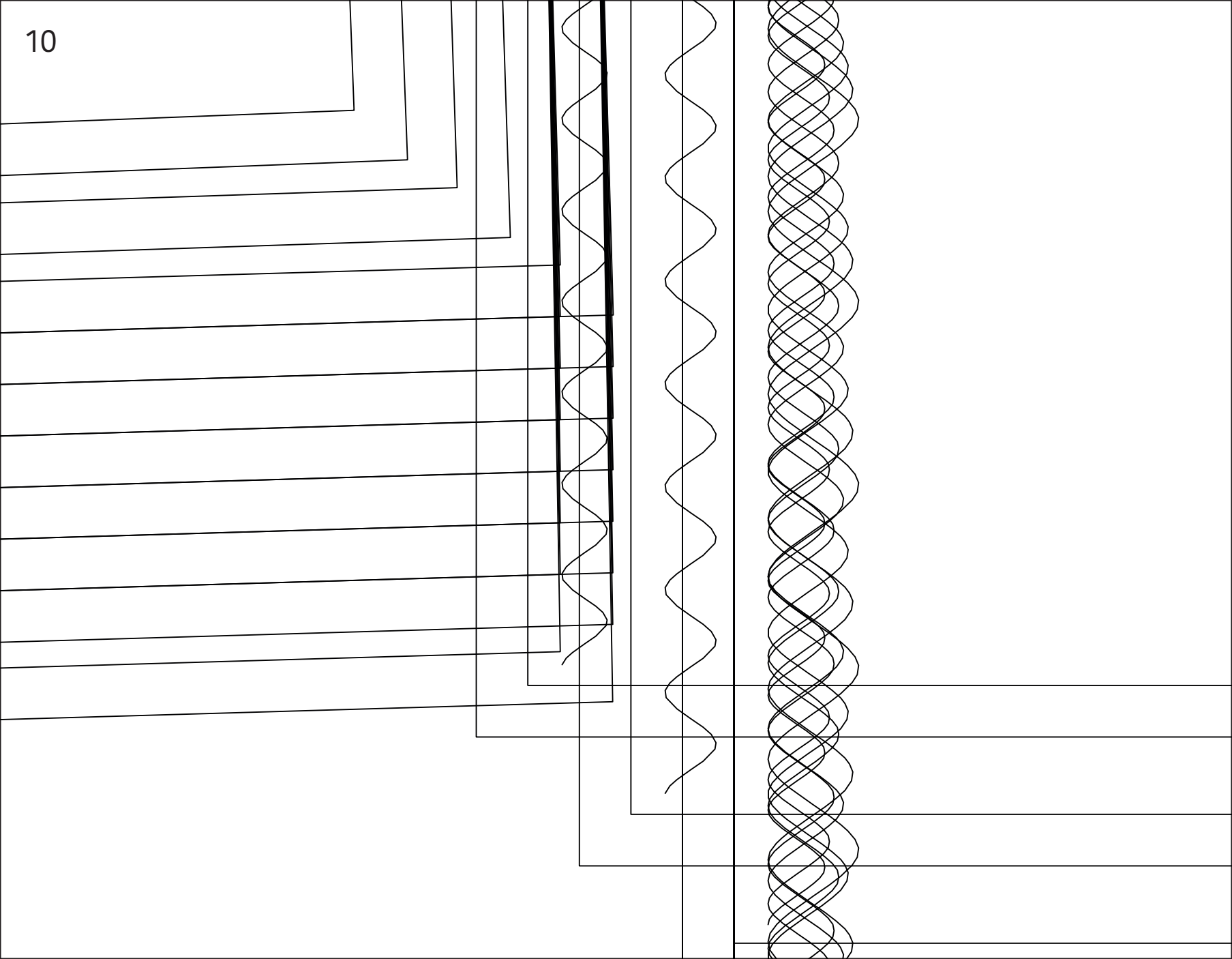



A diagram consisting of three horizontal bars of increasing length from top to bottom. Each bar has a short vertical tick mark on its top surface, centered horizontally. The top bar is the shortest, the middle bar is medium length, and the bottom bar is the longest.

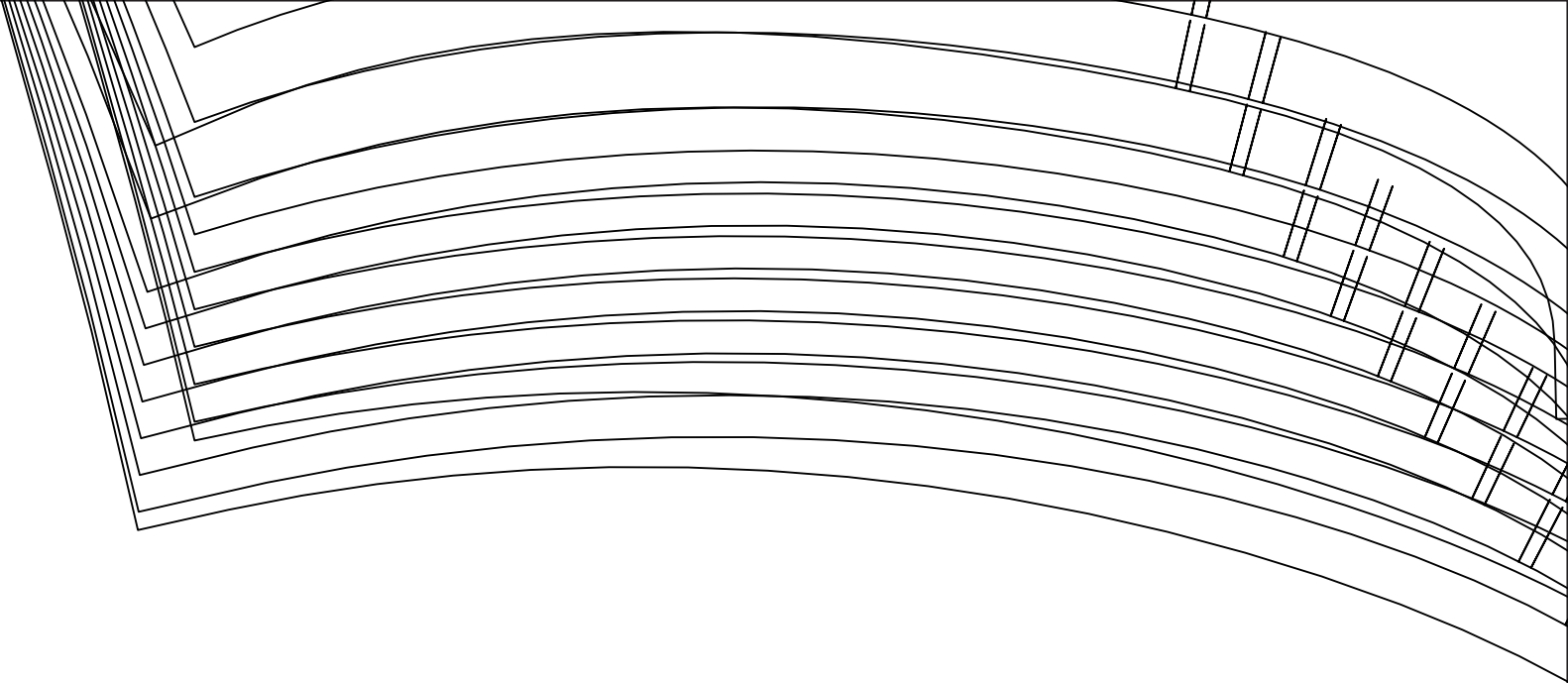

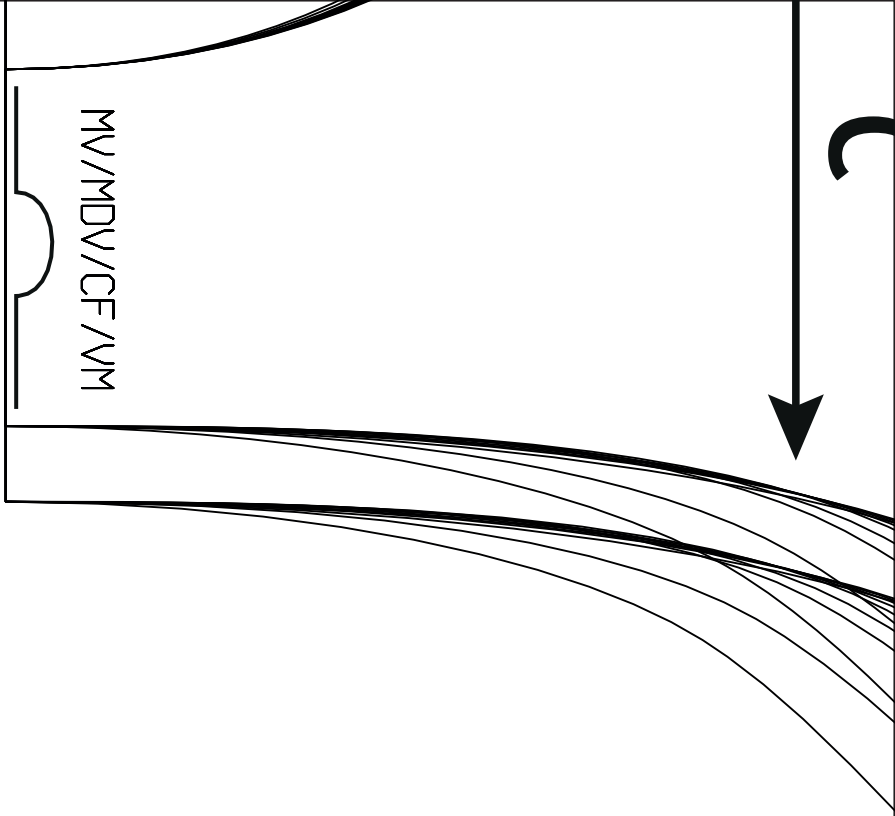
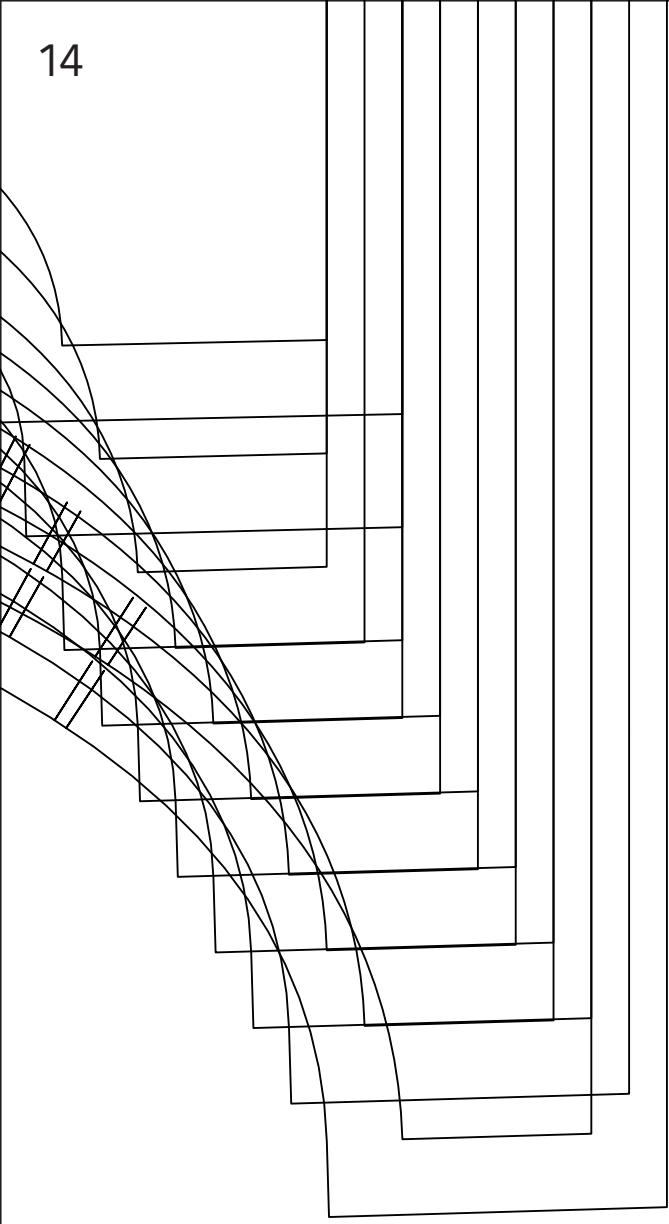

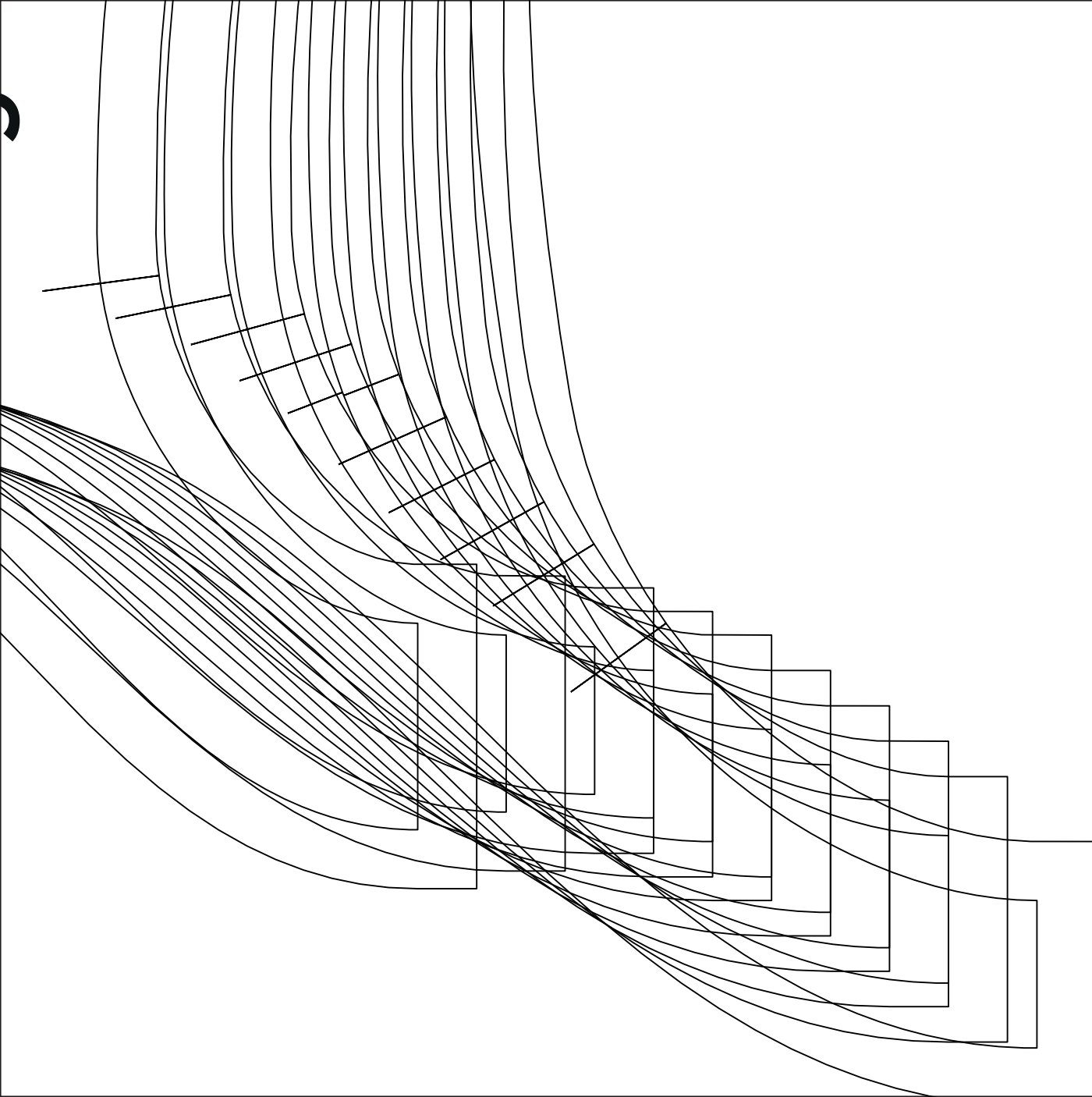

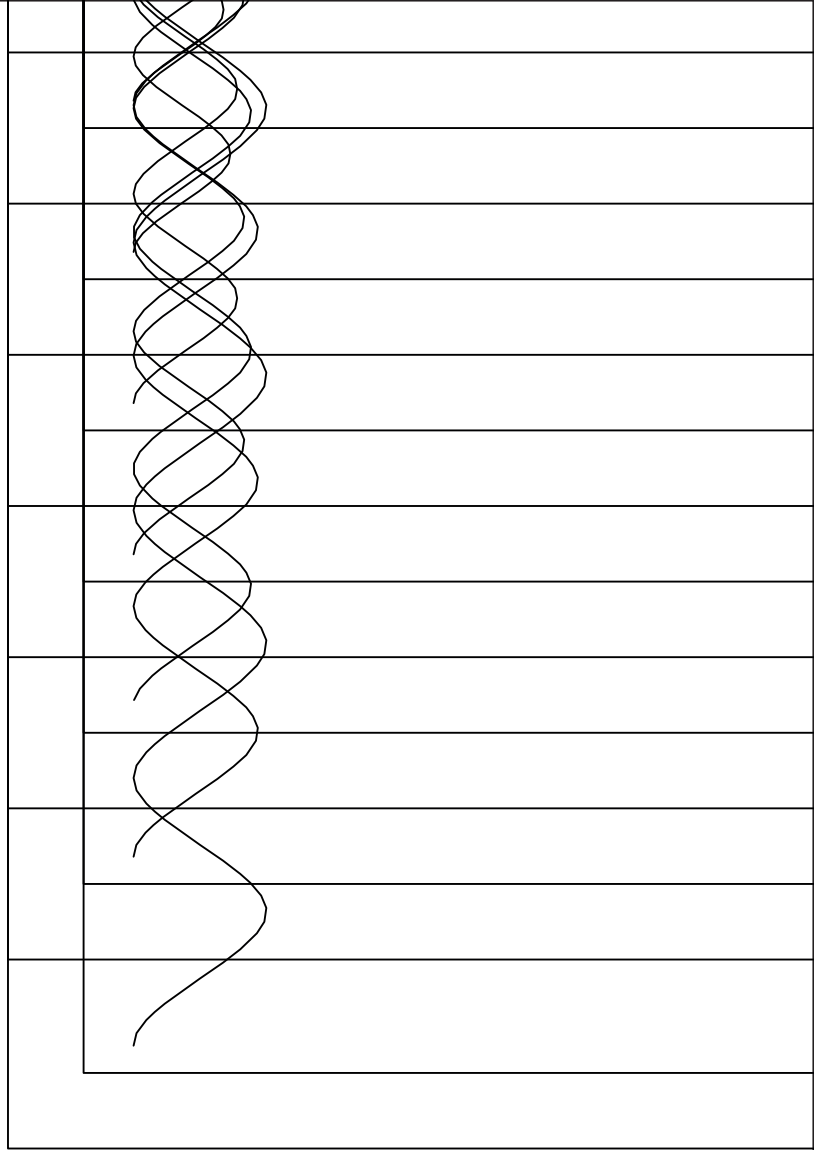

--	--	--	--	--	--	--	--	--	--



MV/MDV/CF/VM



A

