

Patroonschema / Schéma du Patron / Pattern Diagram /
Übersichtsplan zum Zusammenkleben

Enrico

Hemd / Chemise / Shirt / Hemd

Patroondelen / Pièces du patron / Pattern pieces / Schnittteile:

- A** voorpand / devant / front panel /
Vorderteil
- B** rugpand / dos / back panel /
Rückenteil
- C** mouw / manche / sleeve /
Ärmel
- D** kraag / col / collar /
Besatz RT
- E** beleg VP / parementure DV /
Besatz VT
- F** beleg RP / parementure DS /
Besatz RT

1	2	3	4	5	6
7	8	9	10	11	12
13	14	15	16	17	18
X 19	20	21	22	23	24

Controlevierkant / Carré de controle
/ Test square / Kontrollquadrat

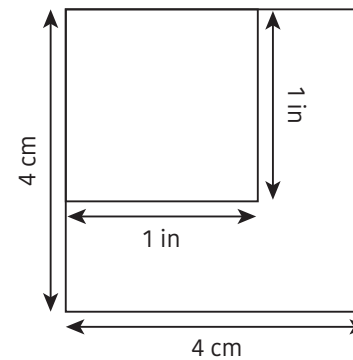

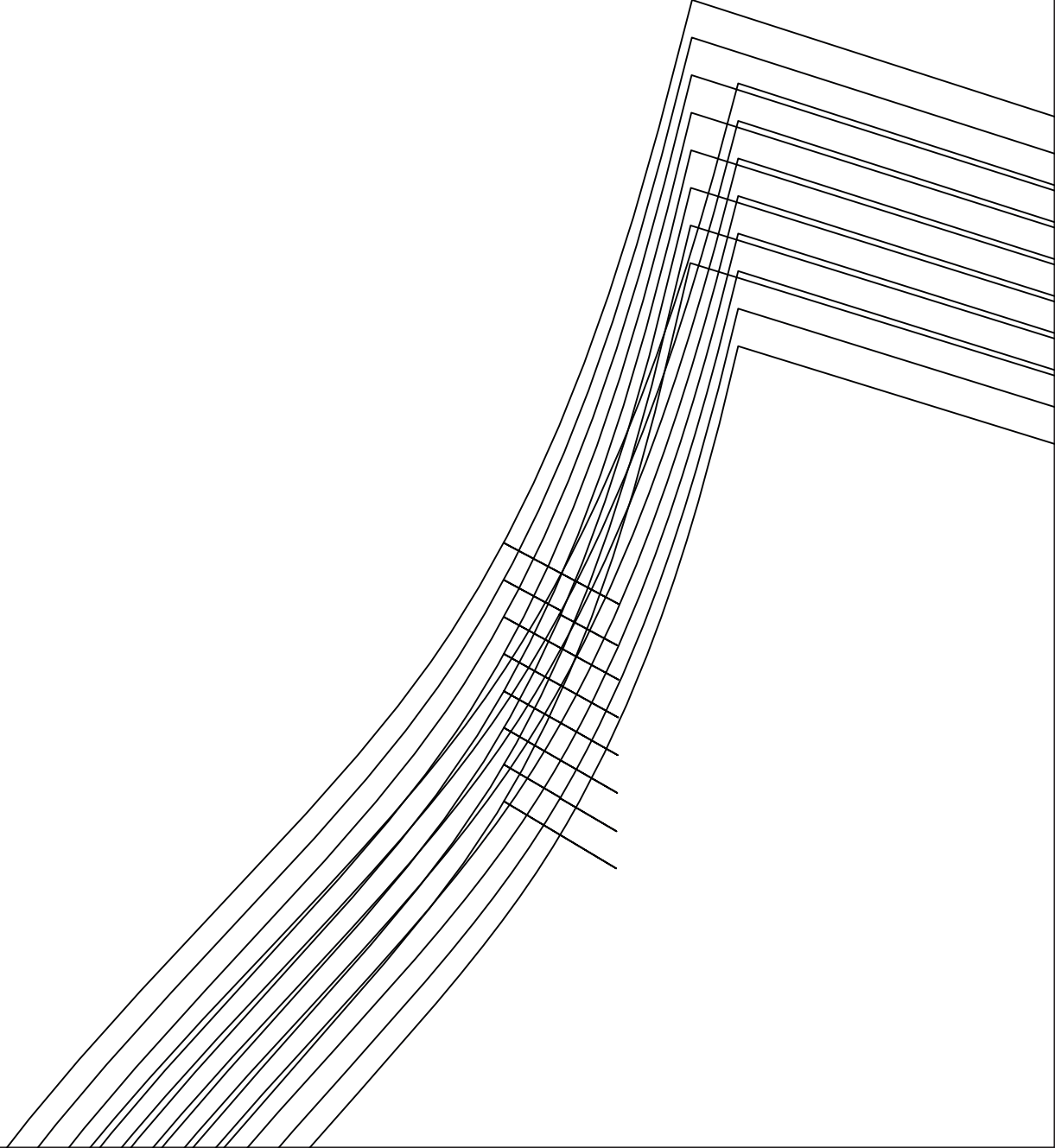

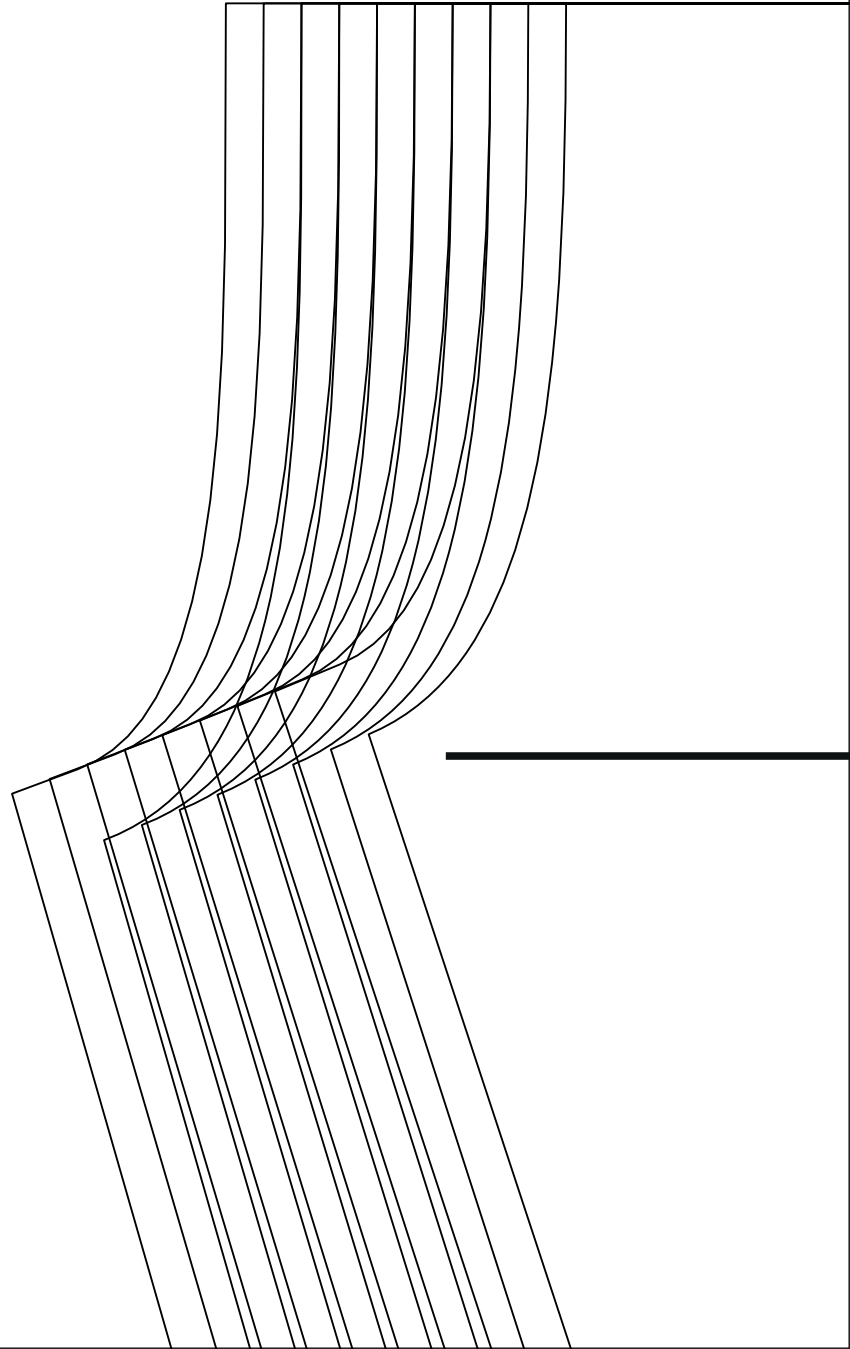
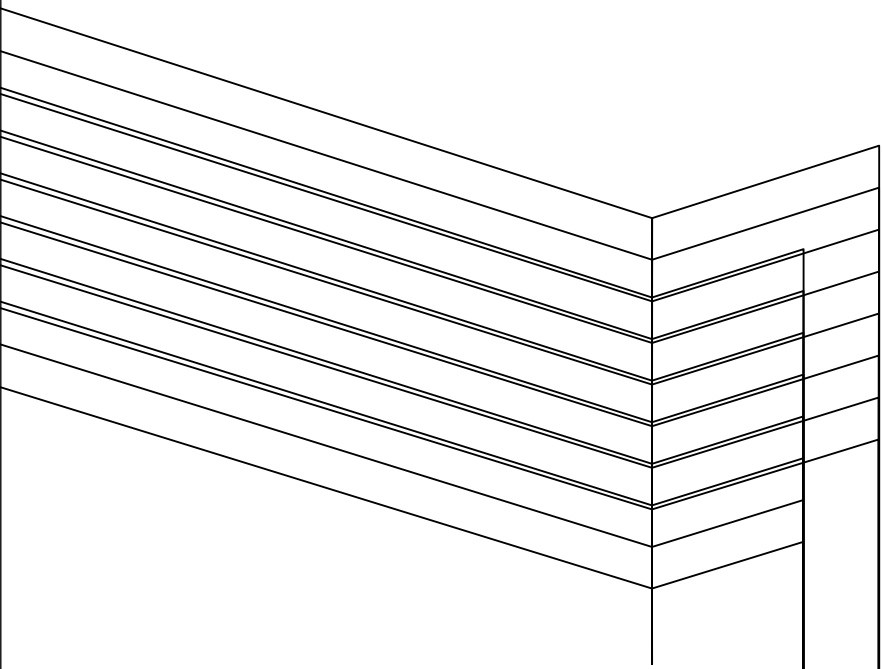

MR/MDS/CB/RM



B

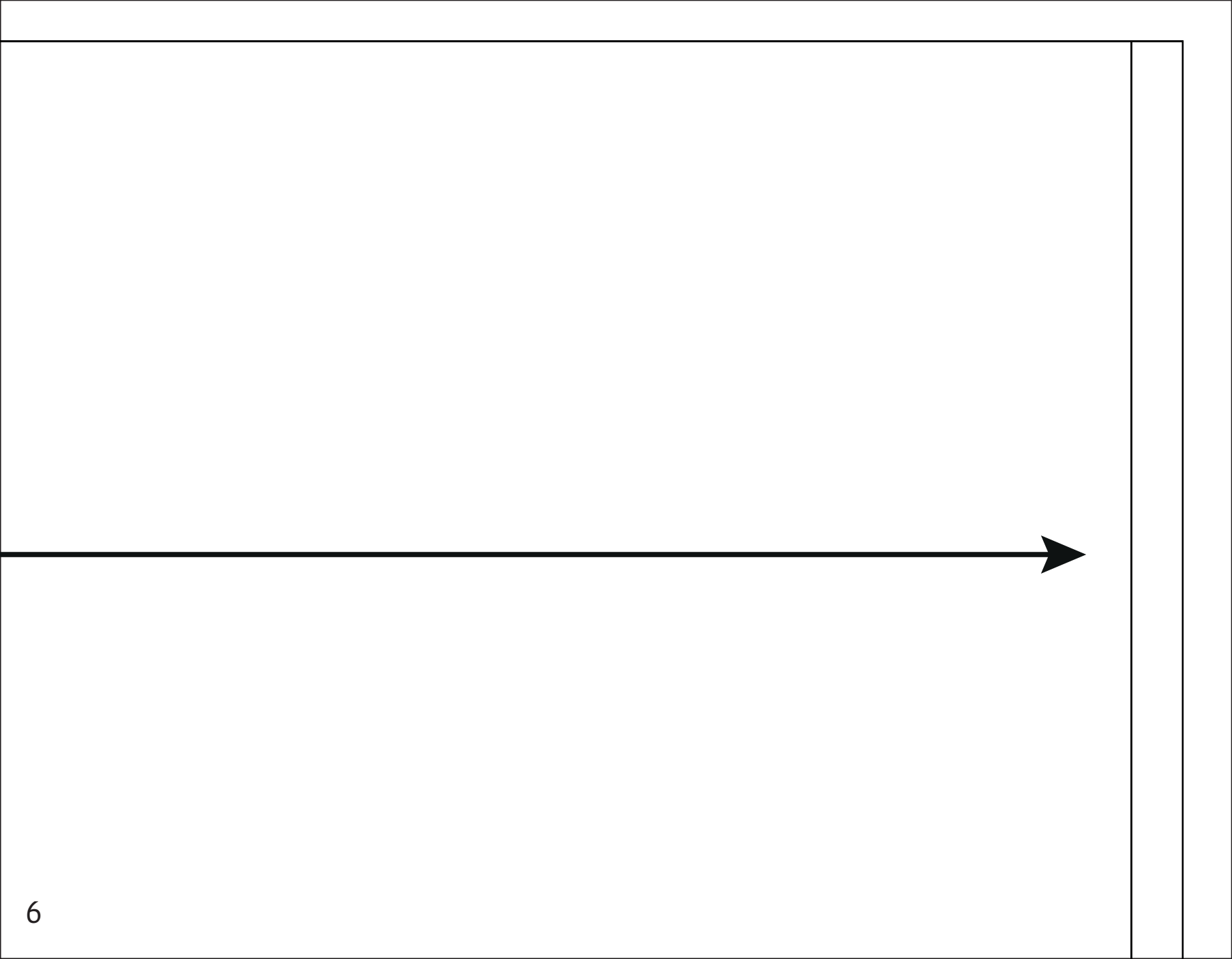

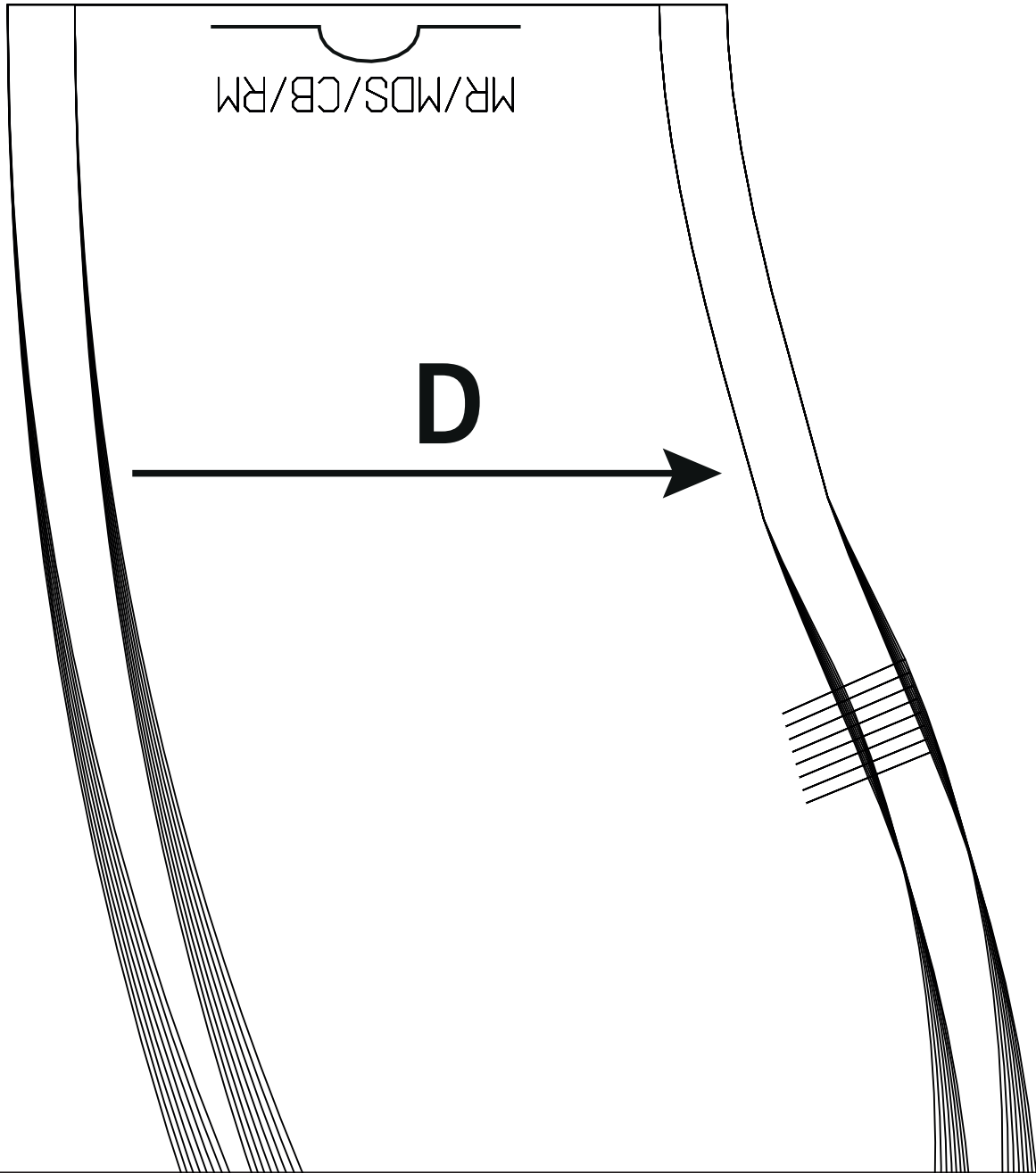

8

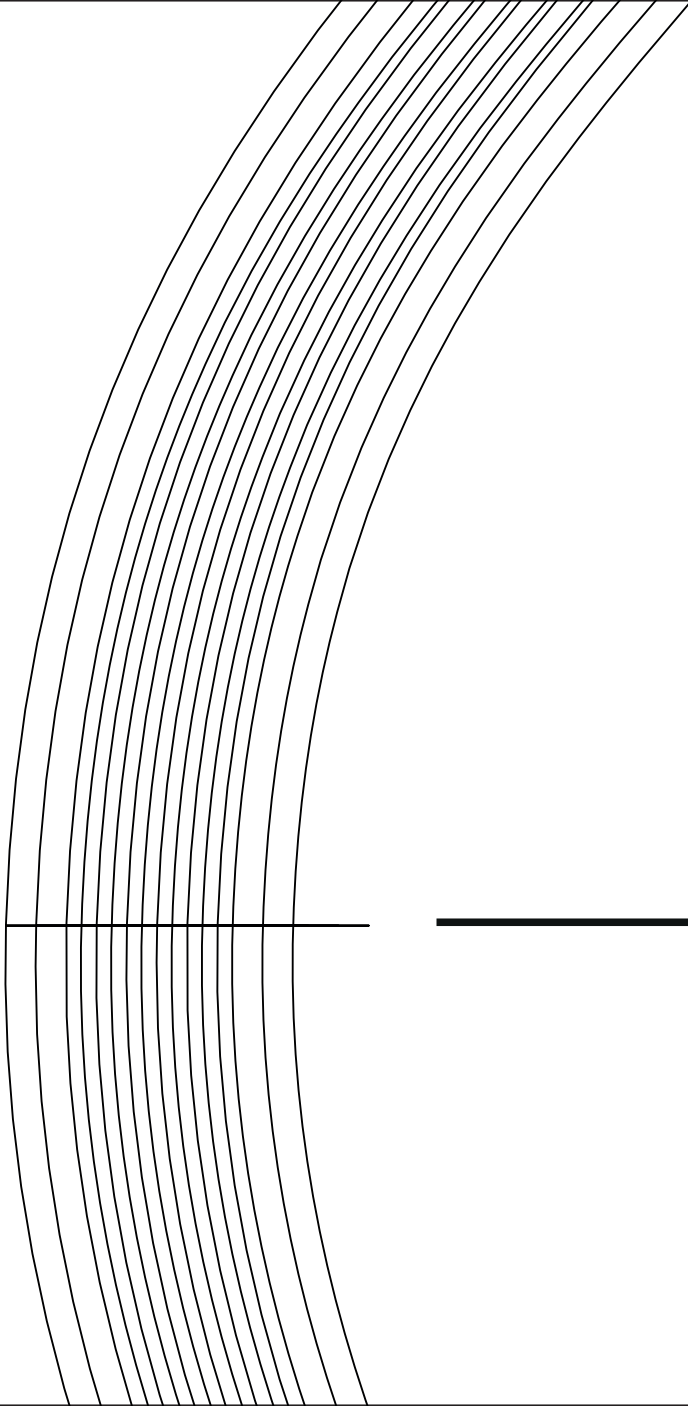

C



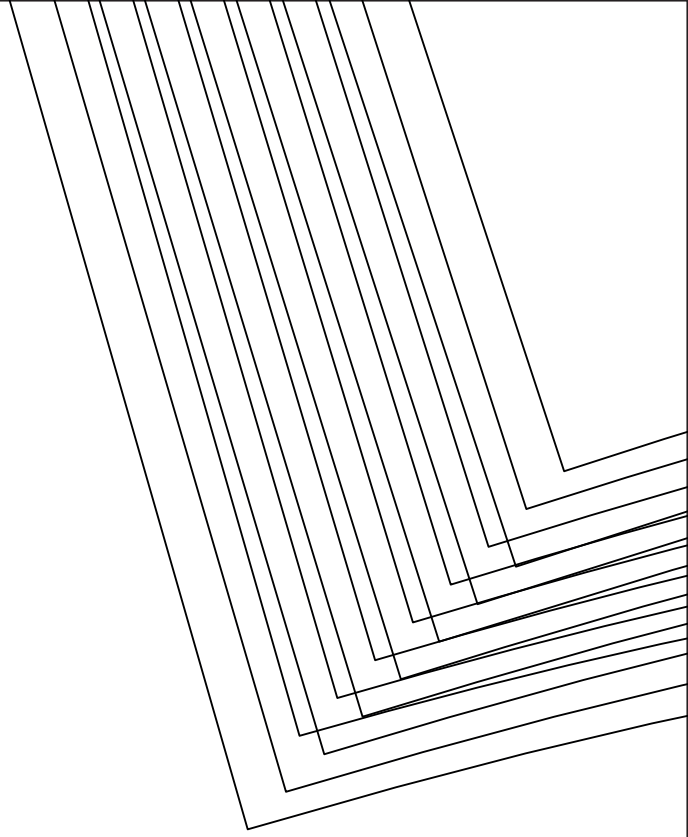

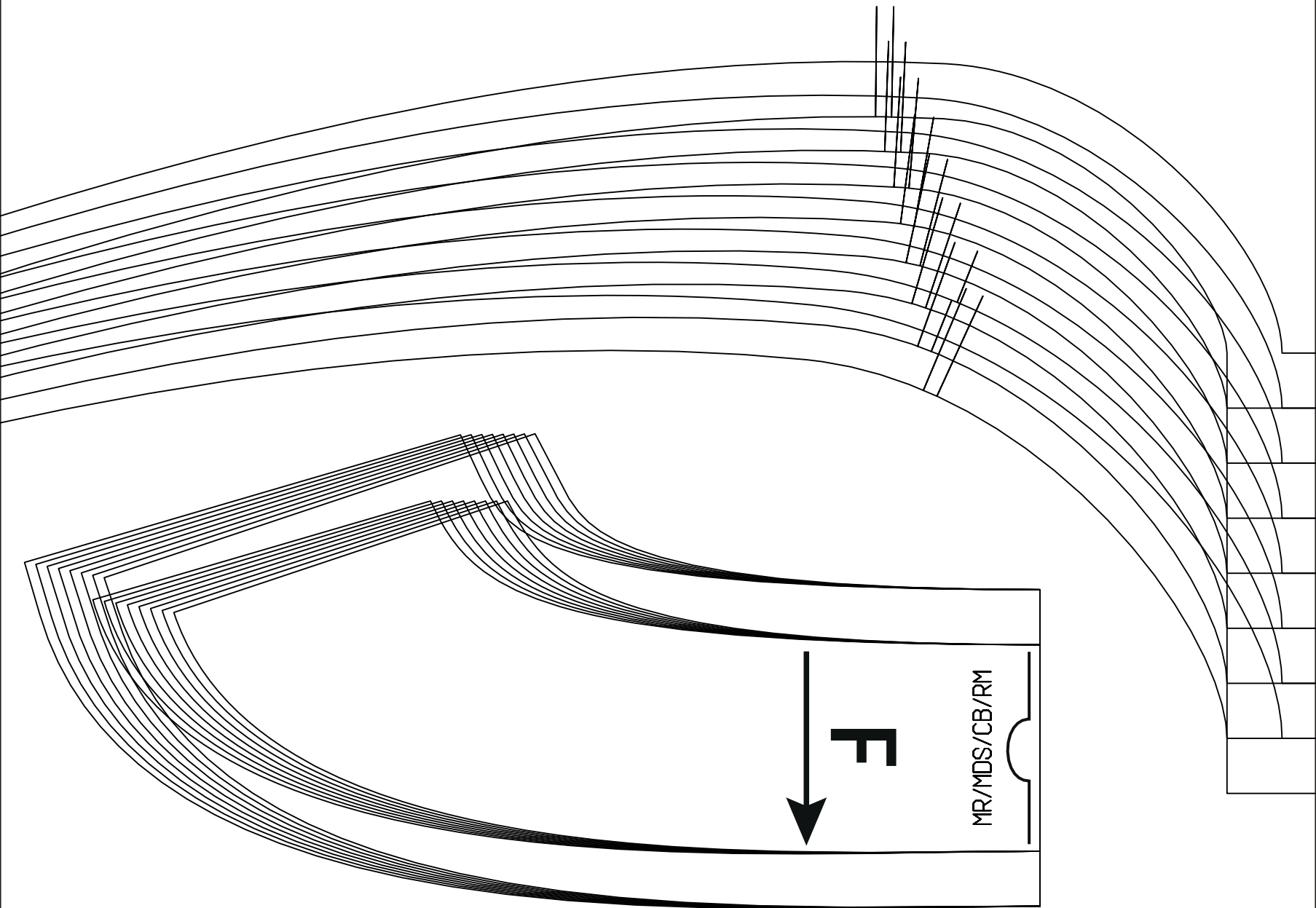

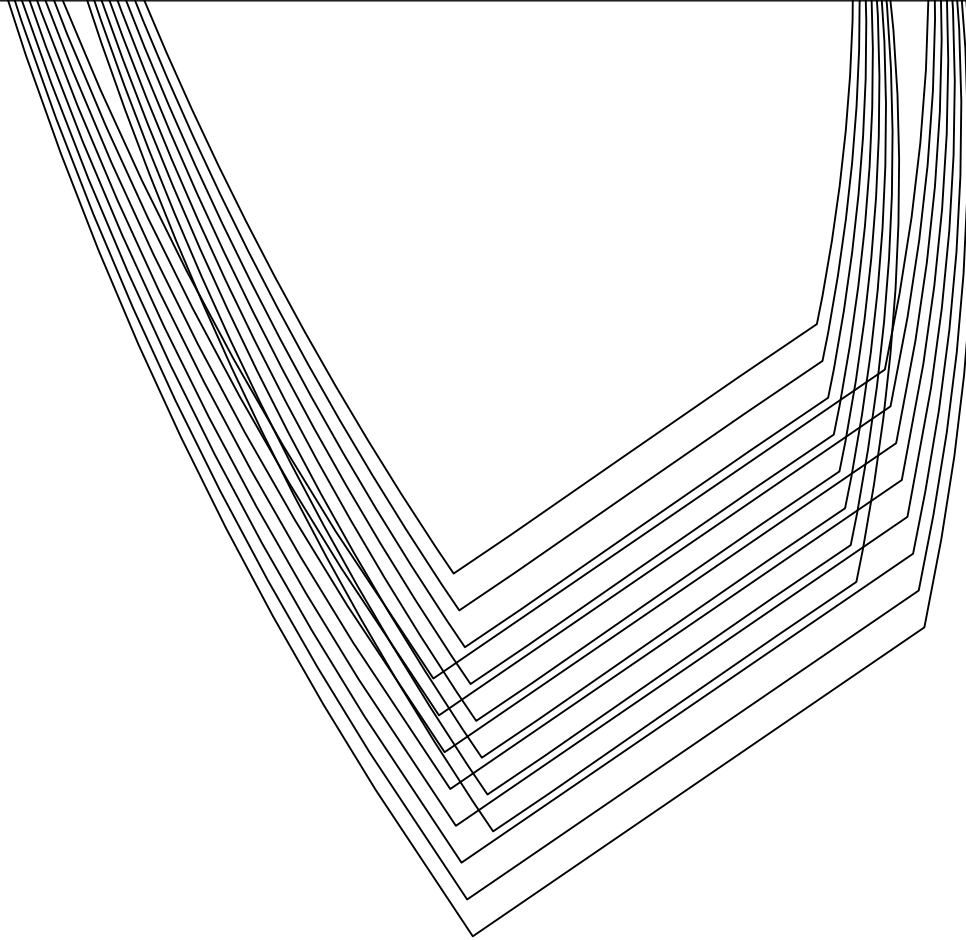

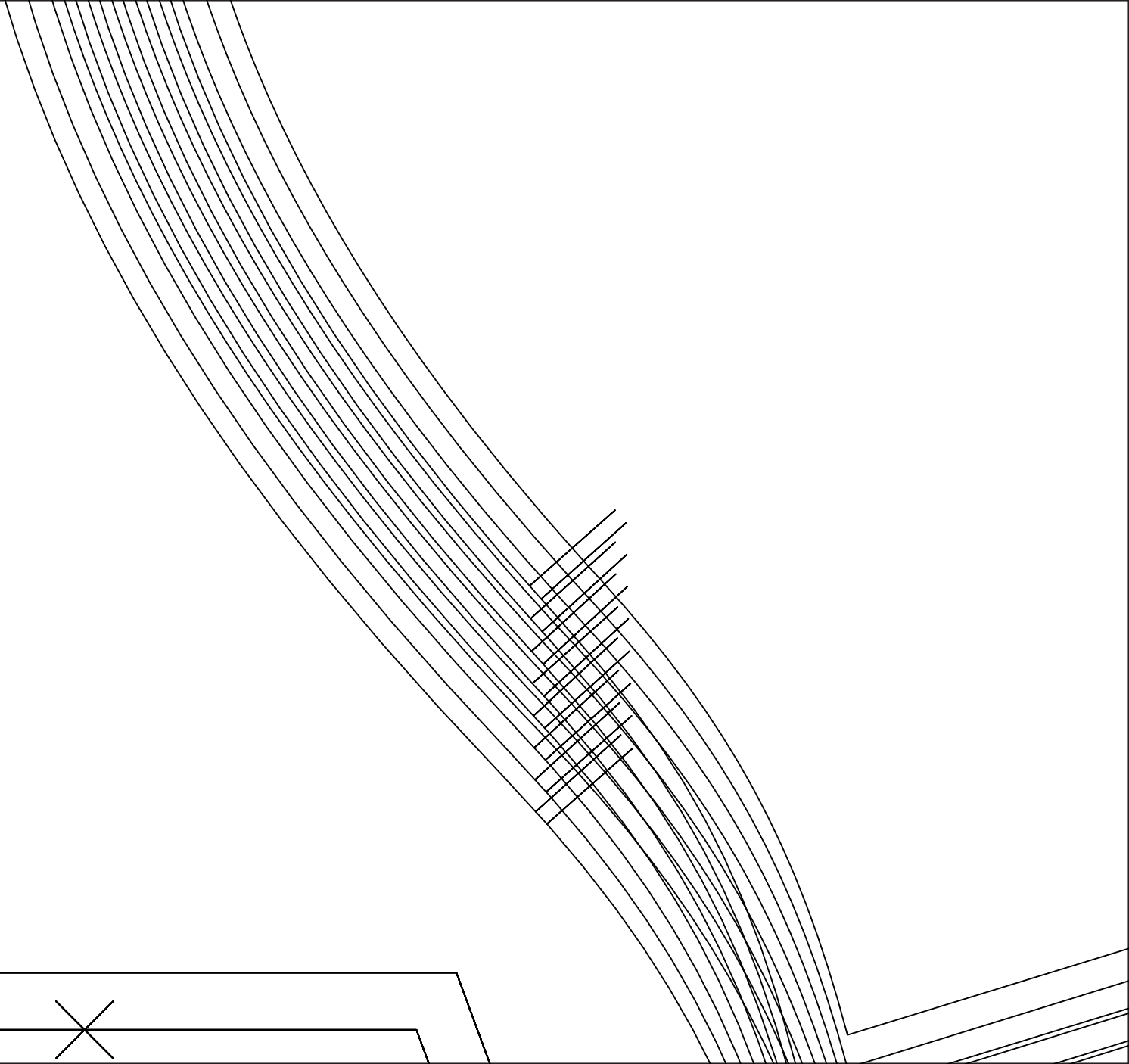

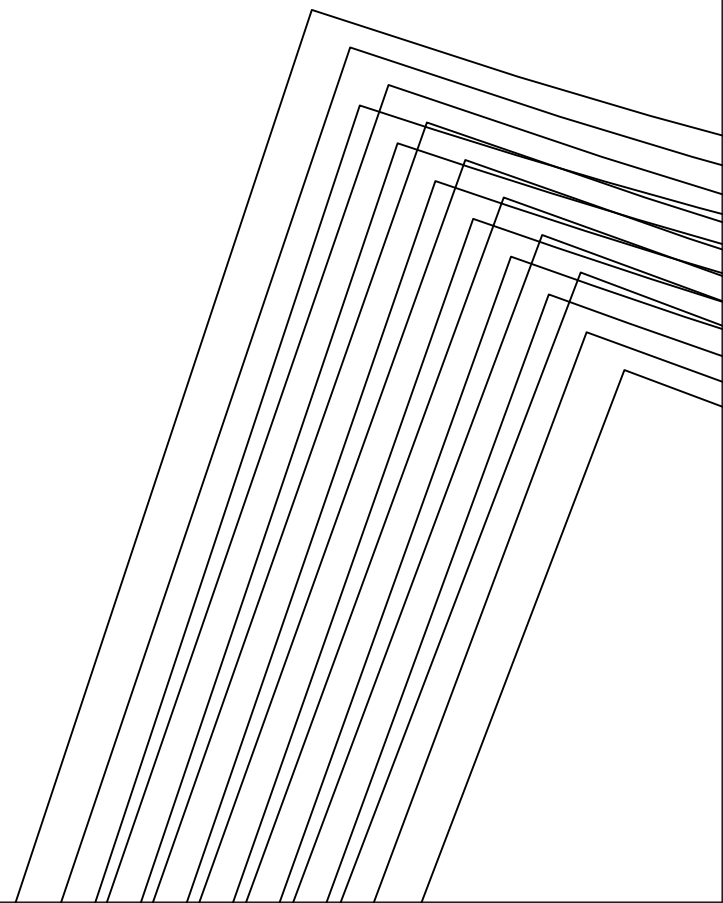
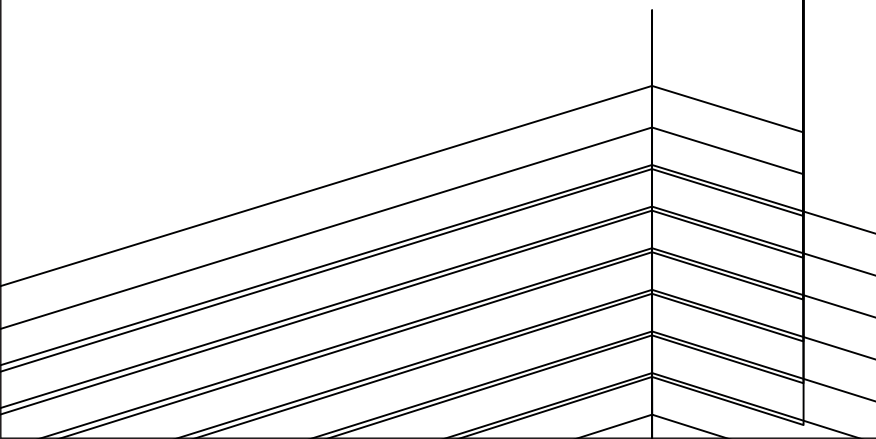

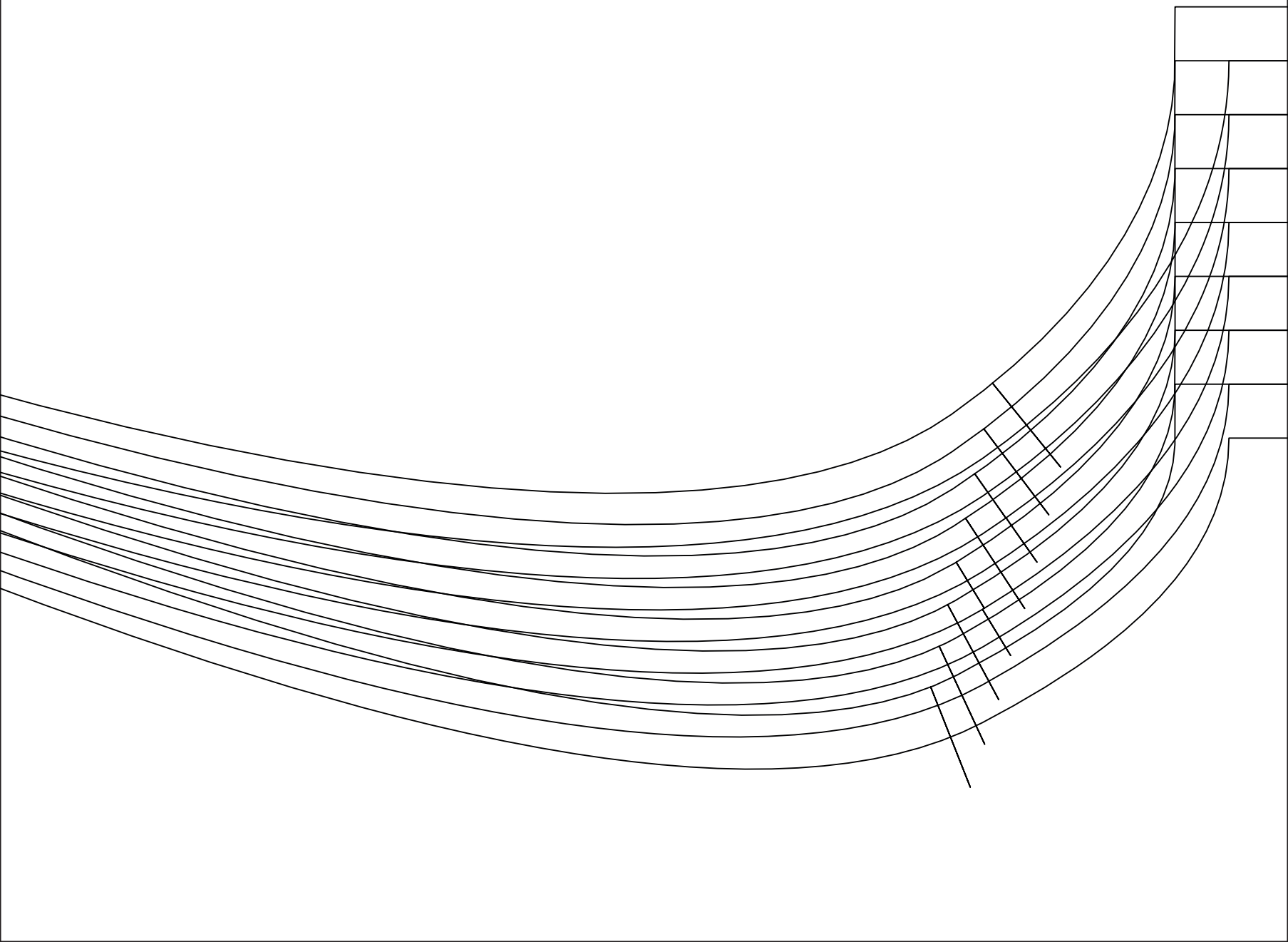

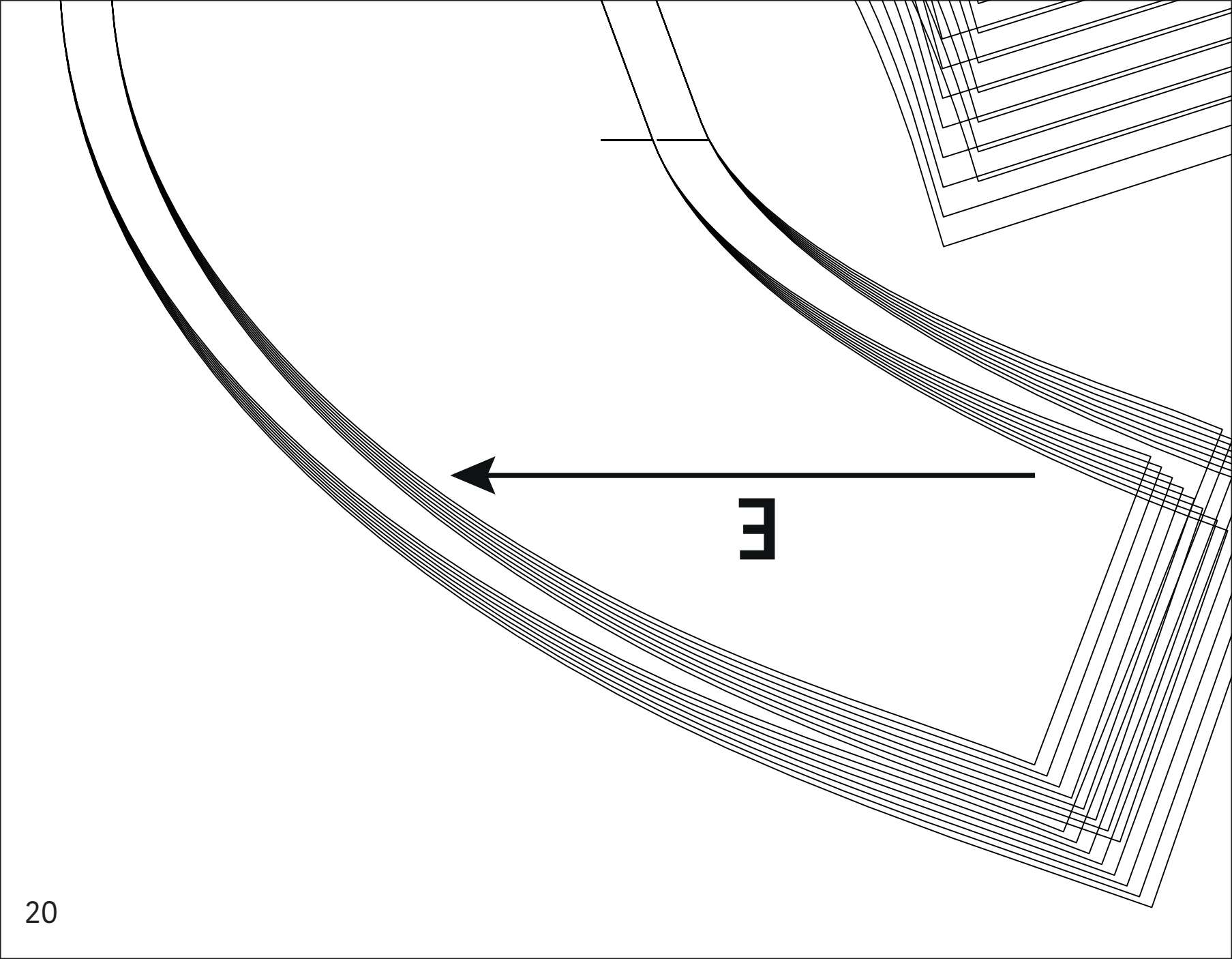

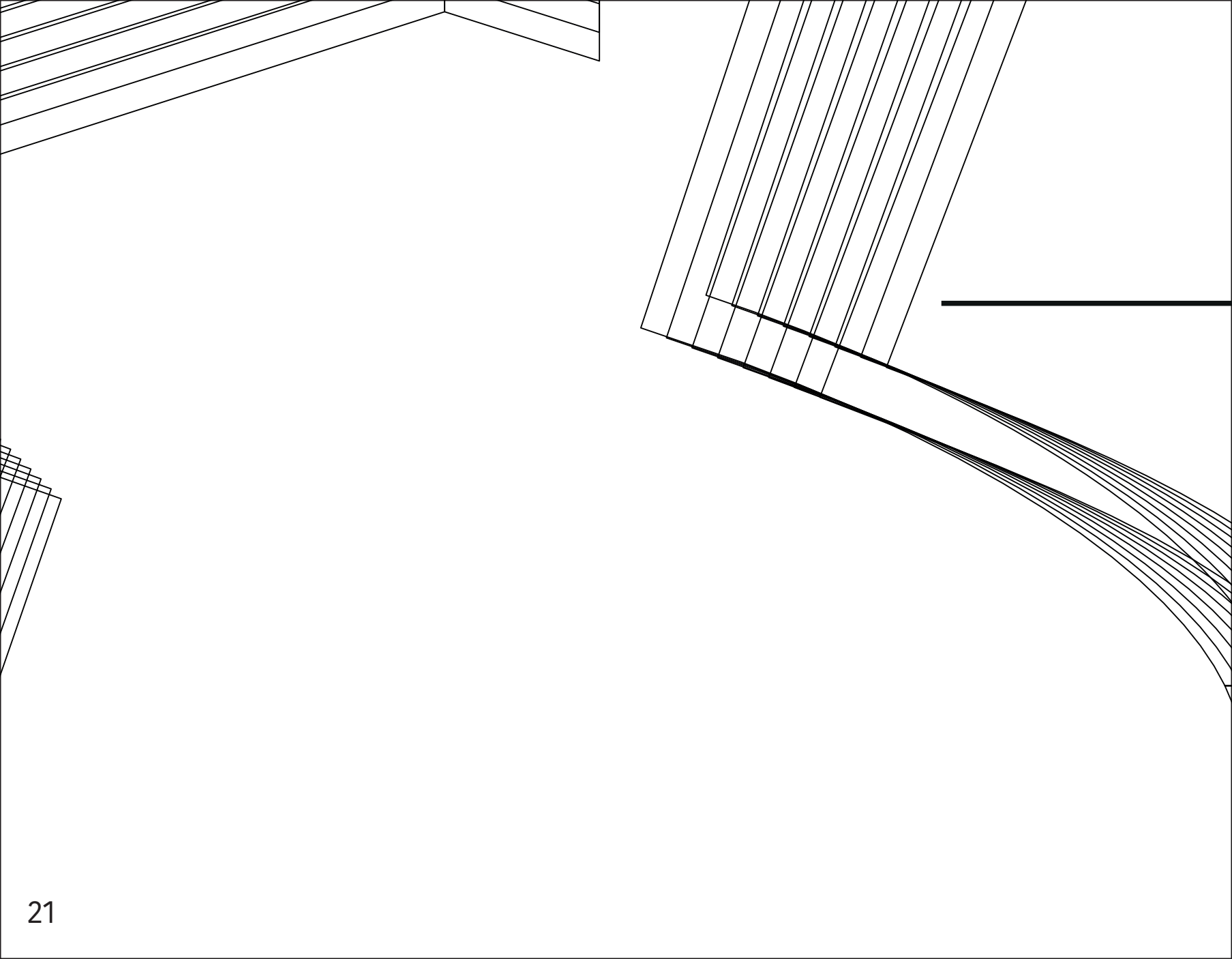

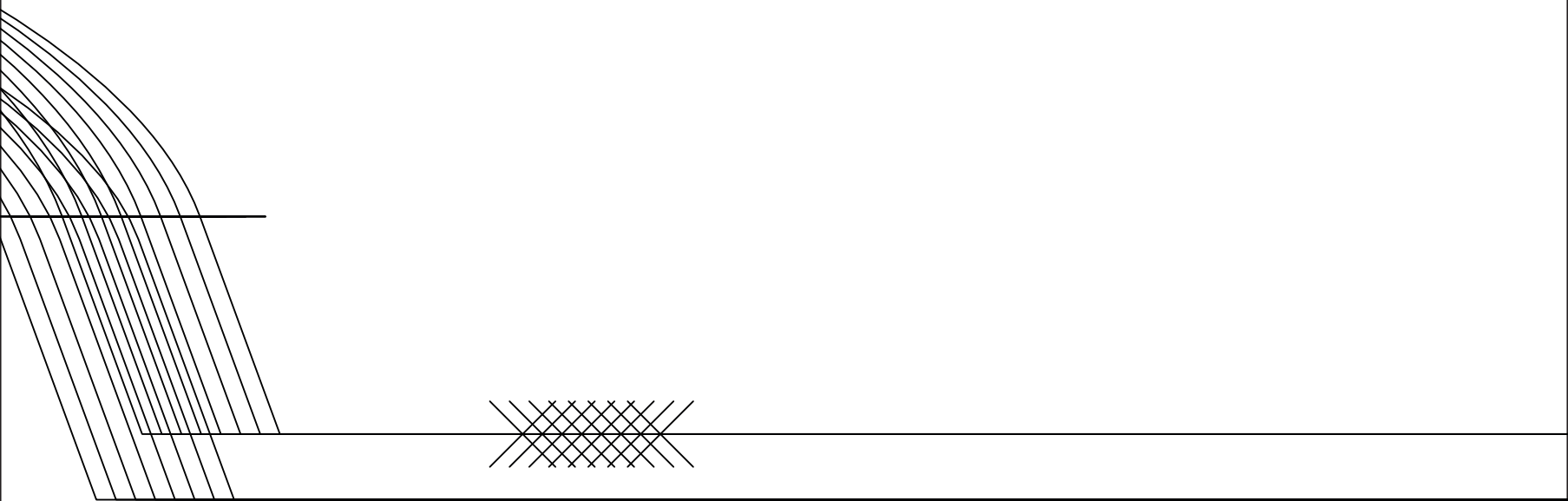

A

