

Harper

Broek / Pantalon / Trousers / Hose

Maten / Tailles / Sizes / Größen:

.....	30
-----	32
-----	34
-----	36
-----	38
-----	40
-----	42
-----	44
-----	46
-----	48

Patroondelen / Pièces du patron / Pattern pieces / Schnittteile:

- A** voorpand / devant / front panel /
Vorderteil
- B** rugpand / dos / back panel /
Rückenteil
- C** zak / poche / pocket / Tasche
- D** inkijk / ouverture / pocket mouth /
Tascheneingriff
- E** tailleband RVP / ceinture DVD /
waistband RFP / Bund RVT
- F** tailleband lvp / ceinture DVG /
waistband LFP / Bund LVT
- G** tailleband RP / ceinture DS /
waistband BP / Bund RT
- H** gulpstuk / braguette / Eingriff
- I** riemlussen / passants /
fly / Gürtelschlaufen
- J** riem / ceinture / belt / Gürtel

Patroonschema / Schéma du Patron / Pattern Diagram / Übersichtsplan zum Zusammenkleben

1	2	3	4	5	6
7	8	9	10	11	12
13	14	15	16	17	18
19	20	21	22	23	24
25	26	27	28	29	30

Controlevierkant / Carré de controle / Test square / Kontrollquadrat

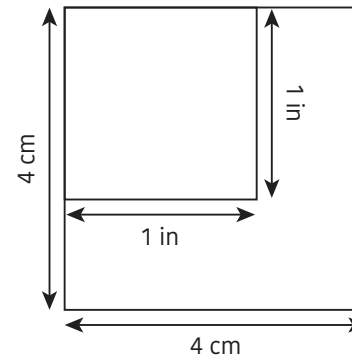

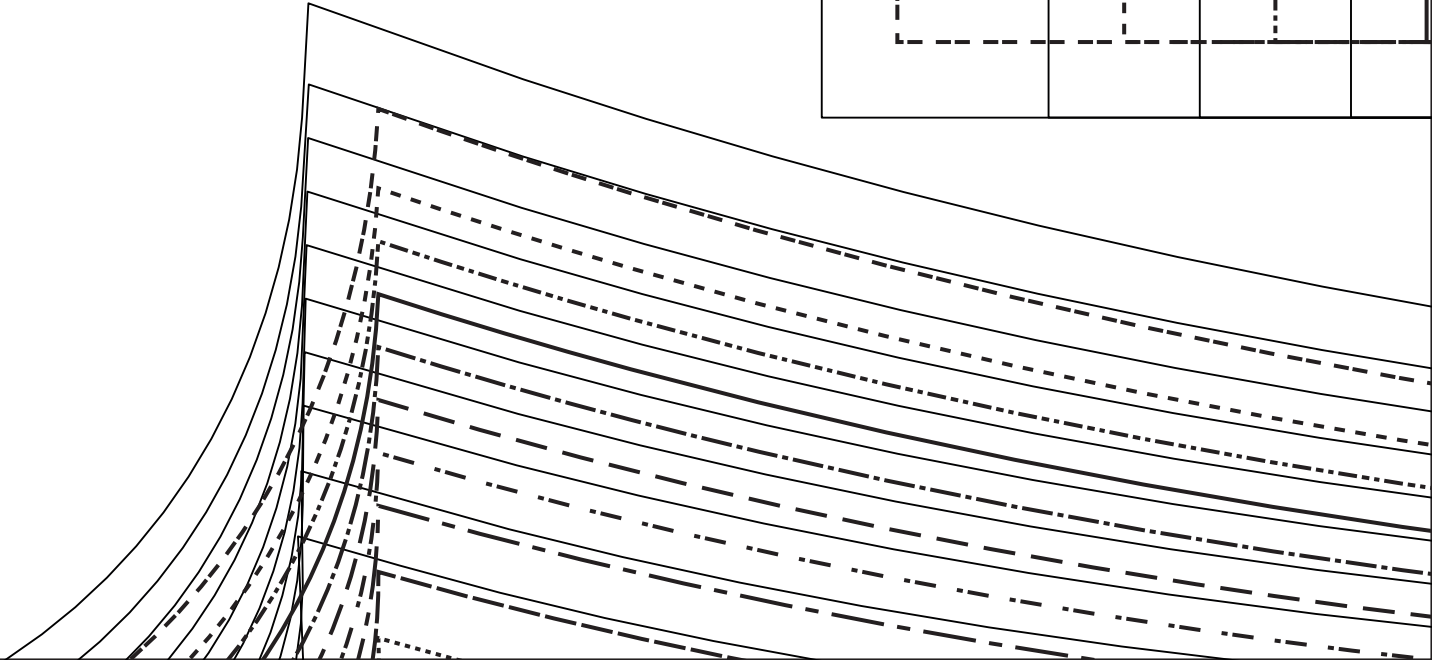
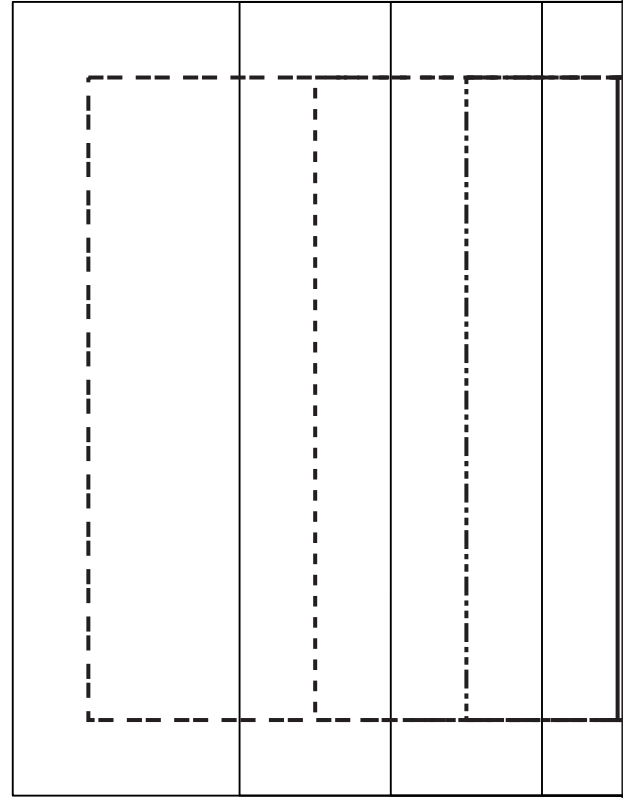

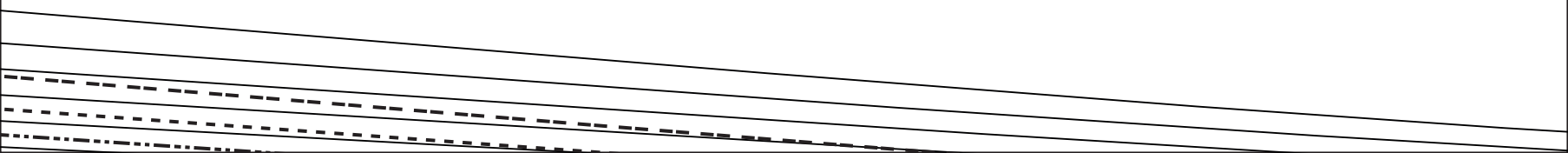

J

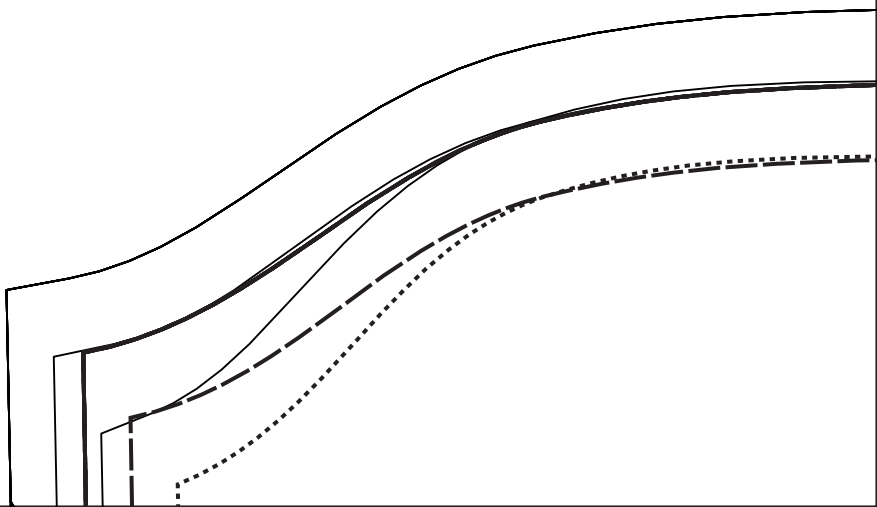

6

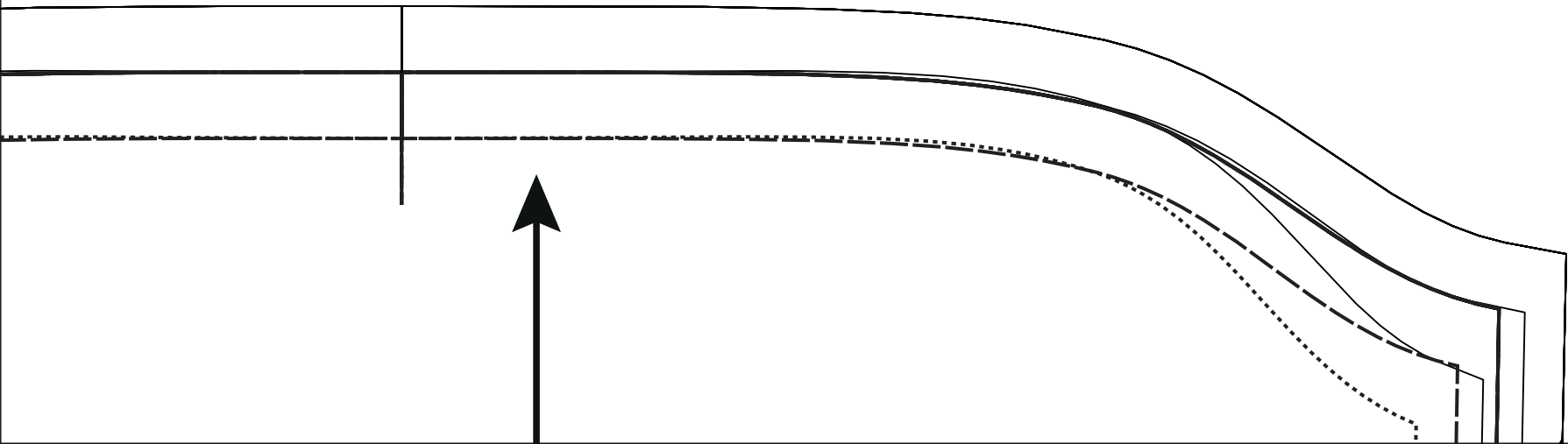
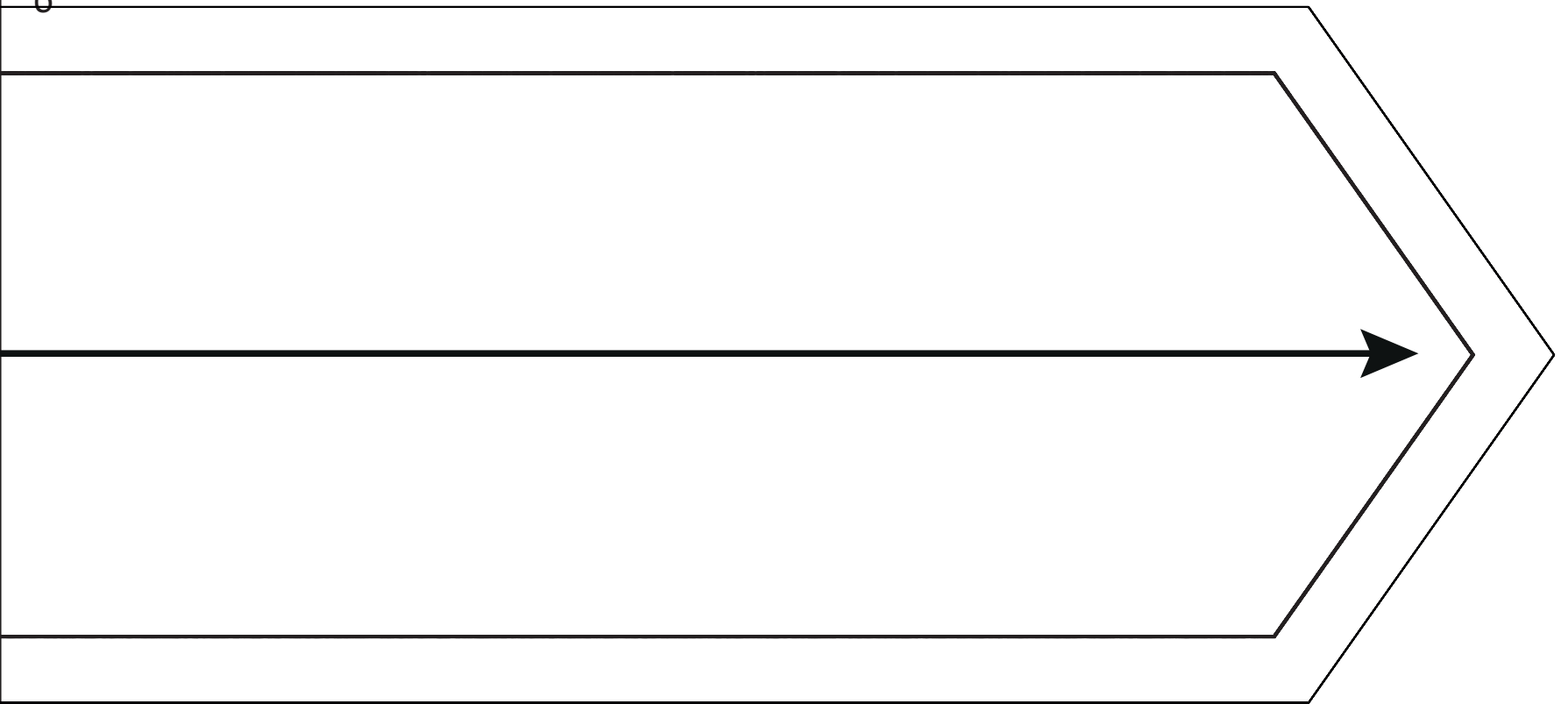

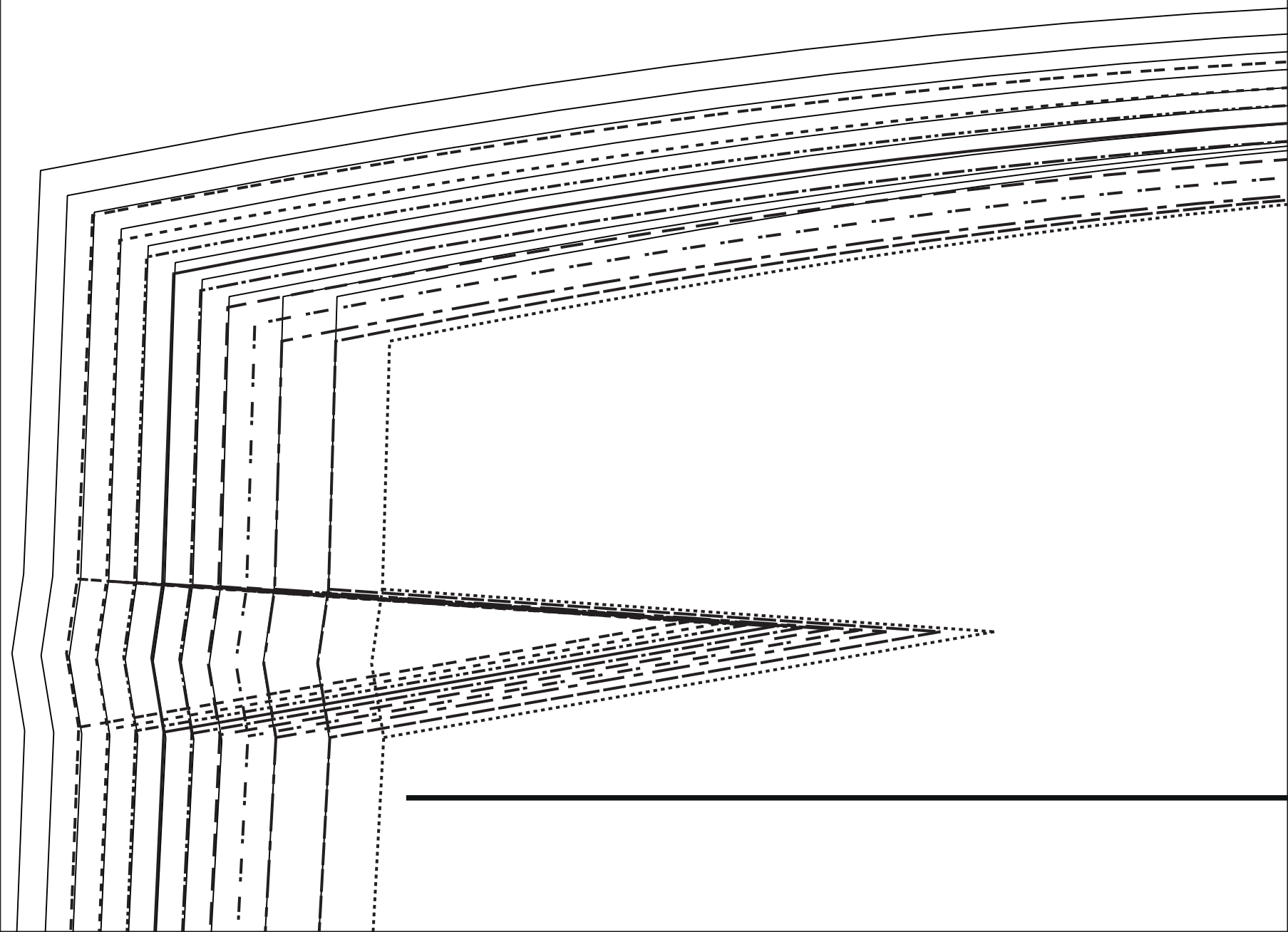

8

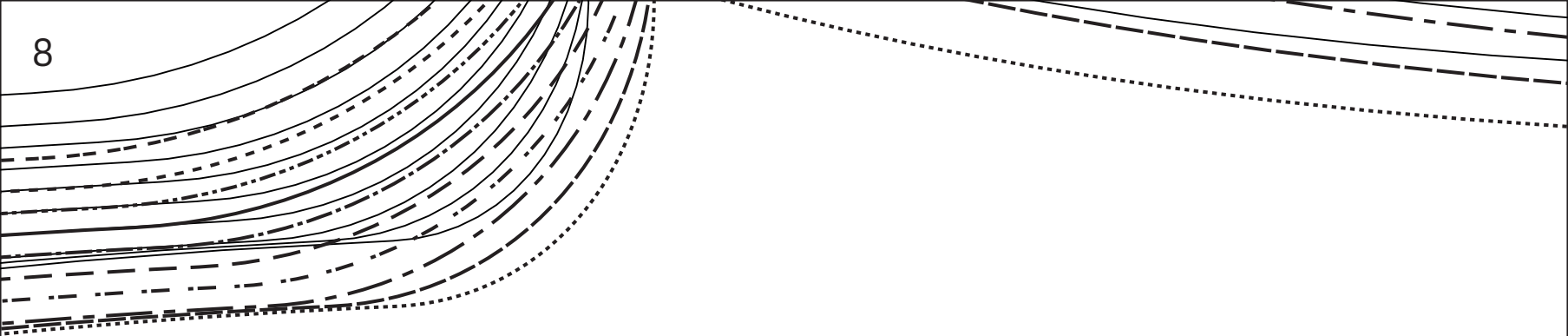

B

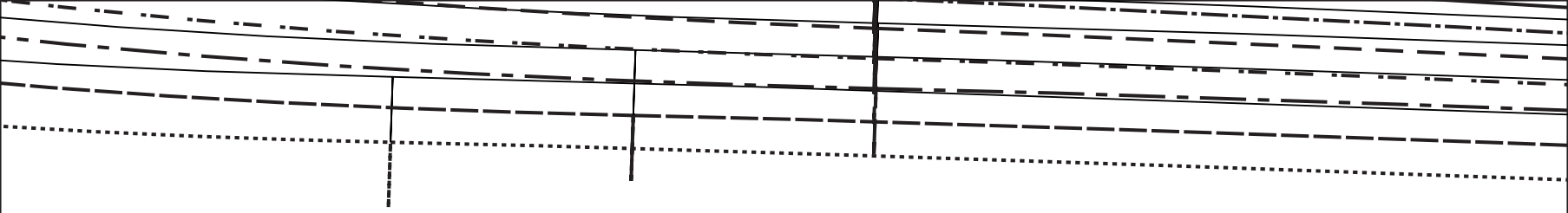

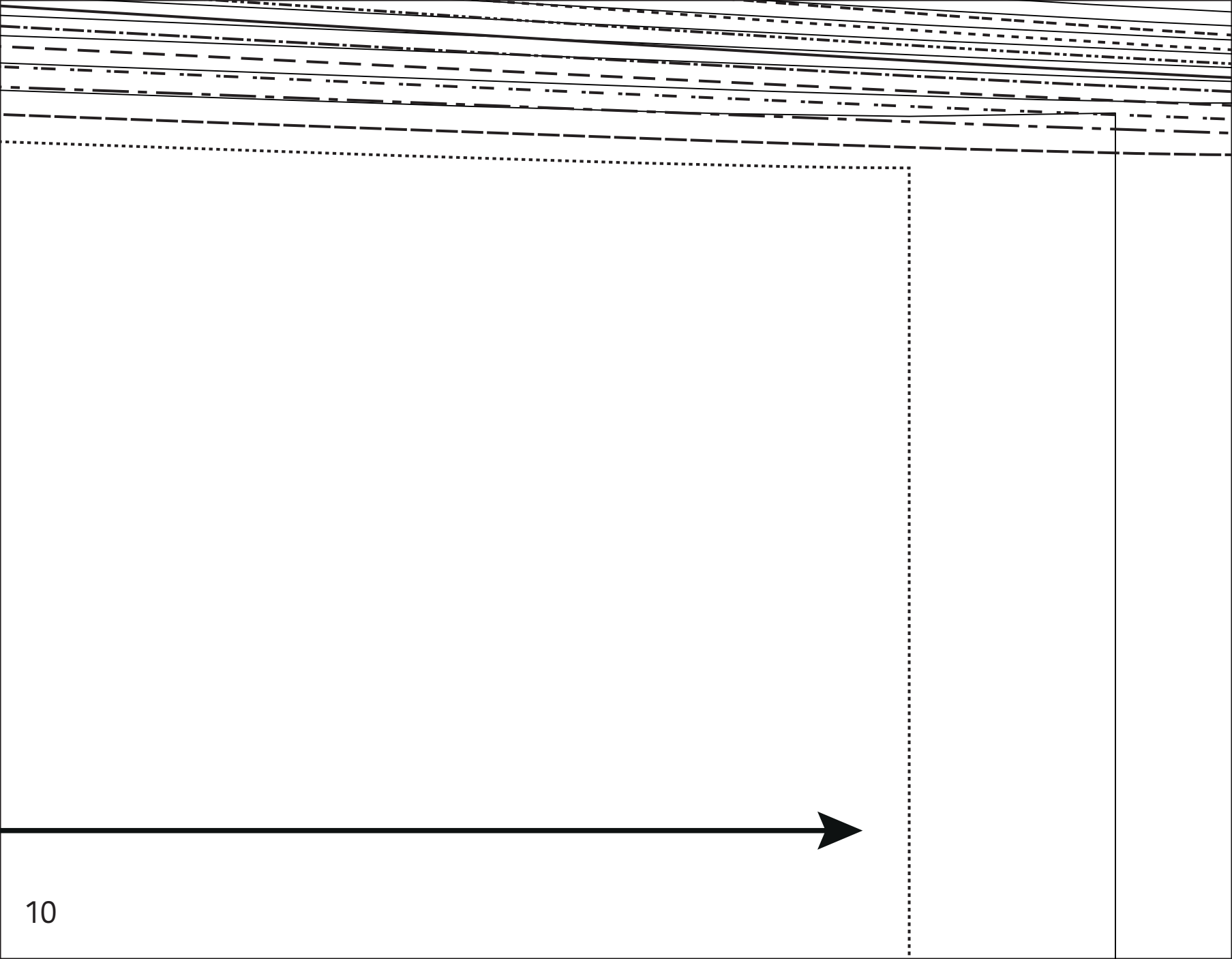

10

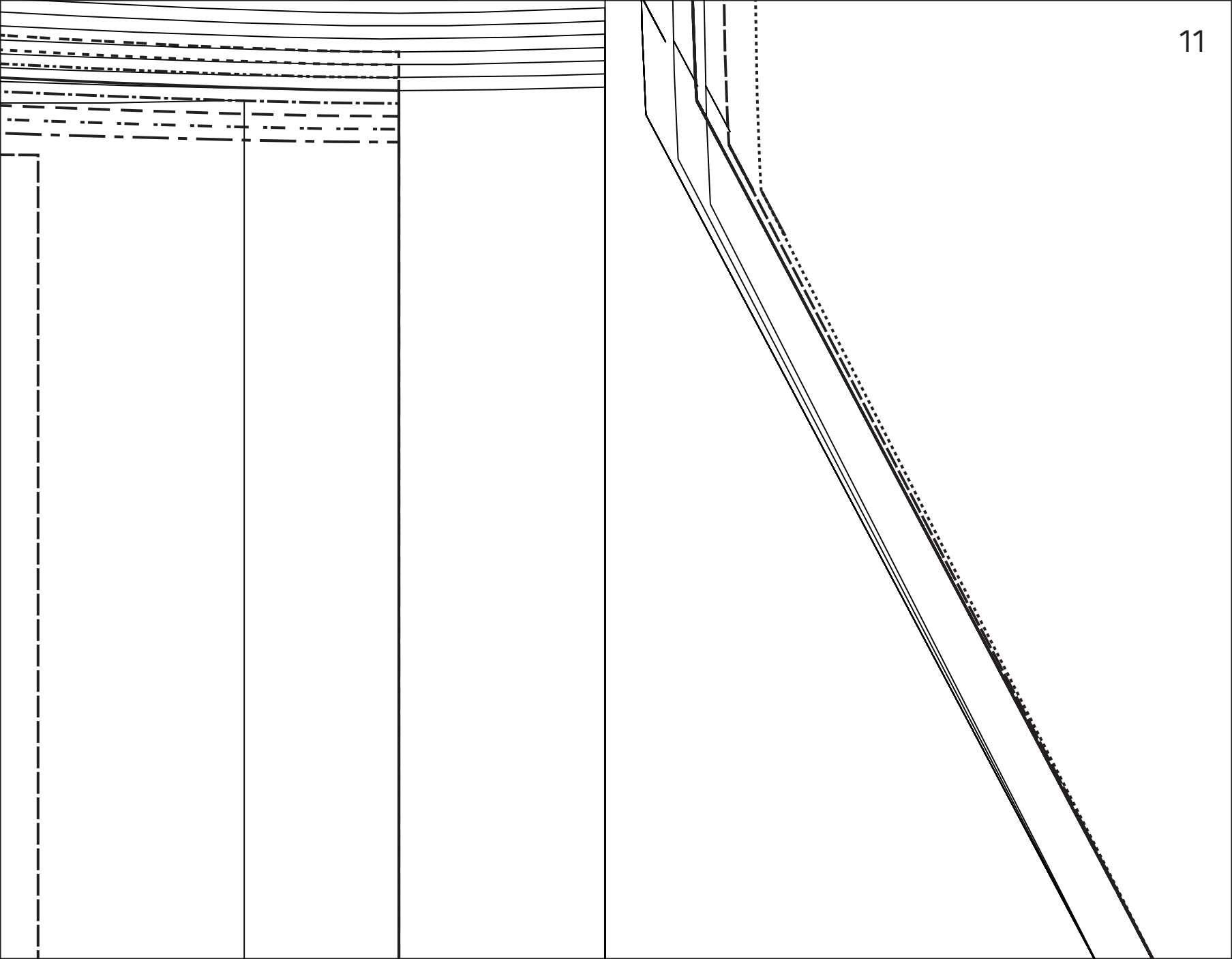

C

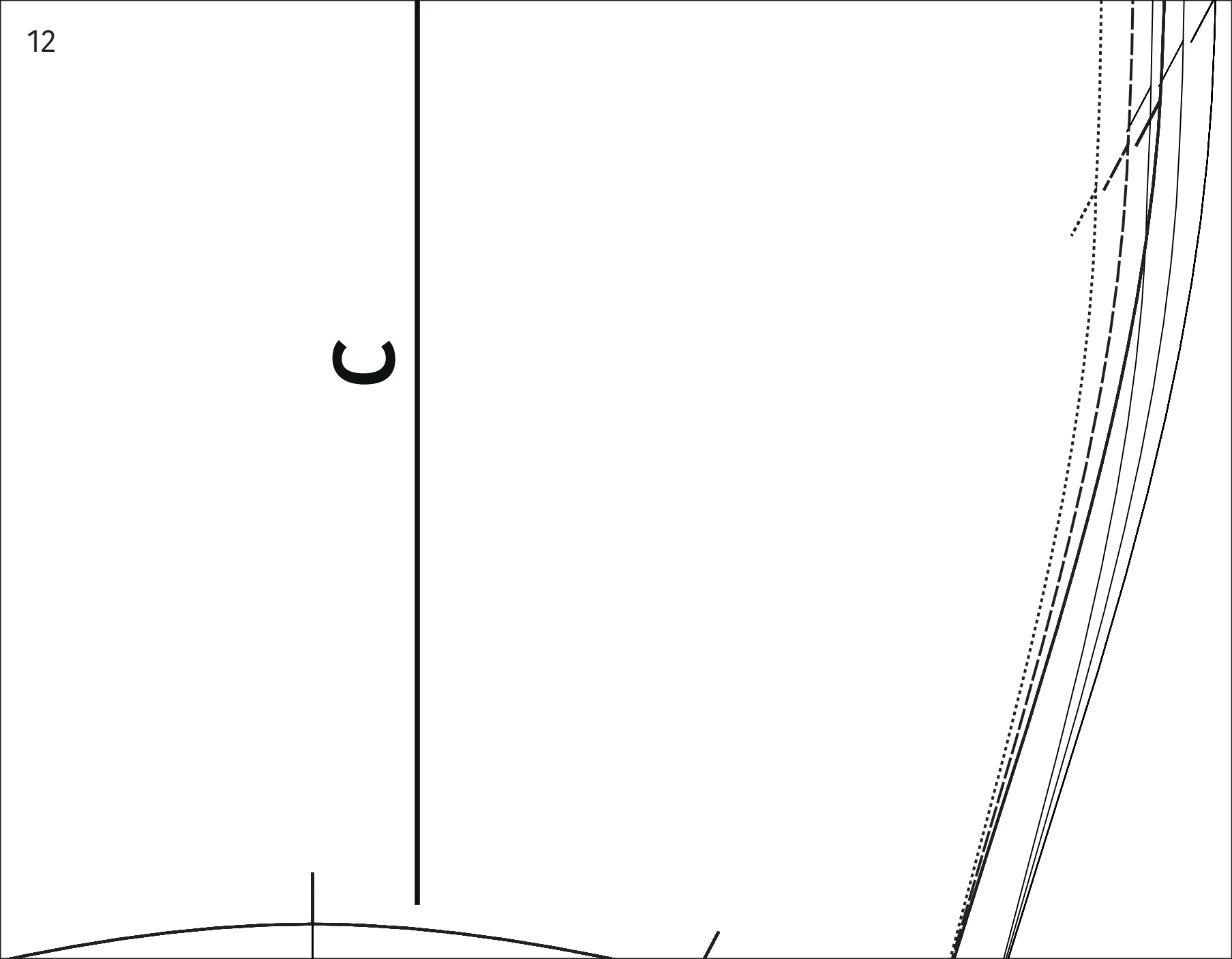

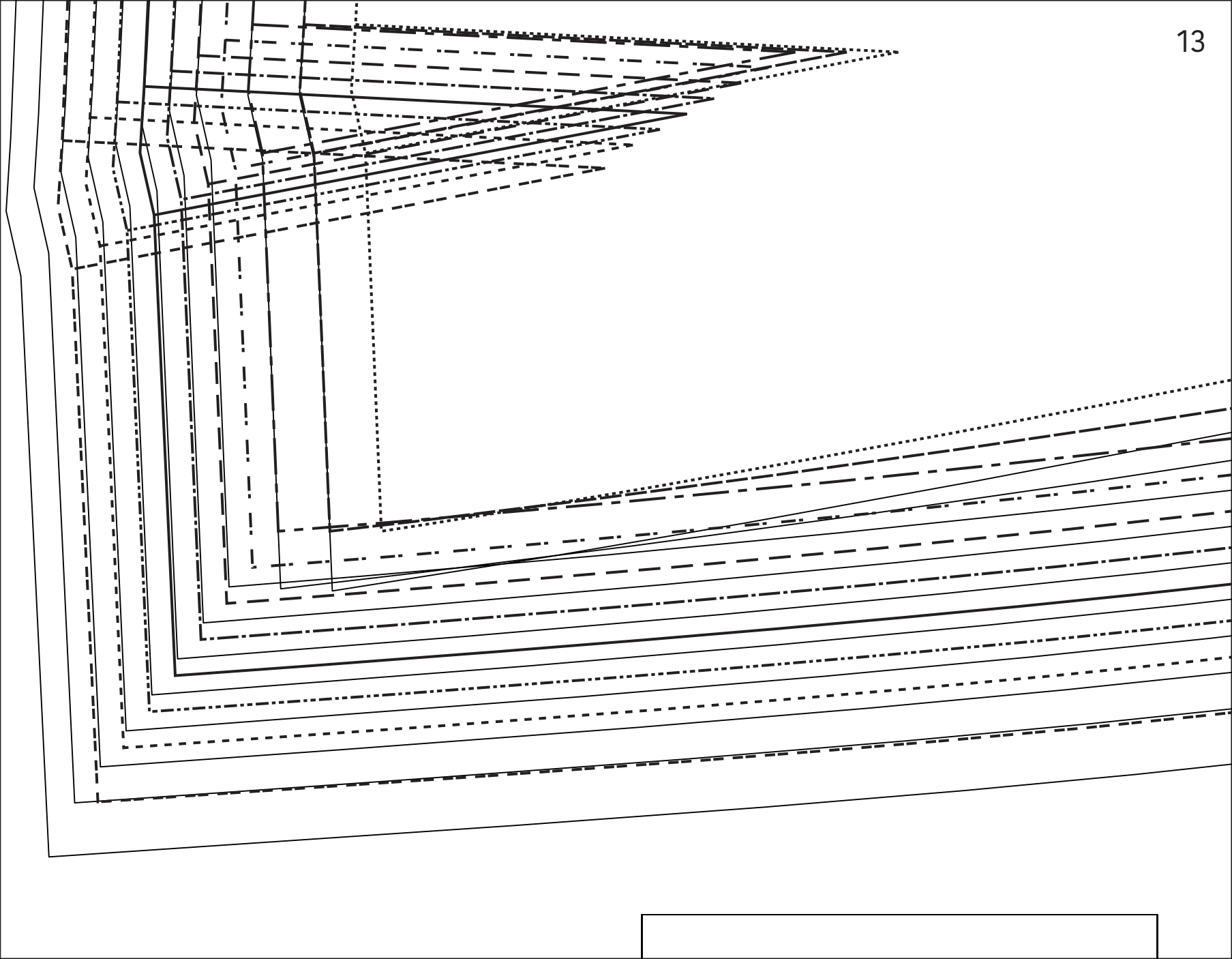

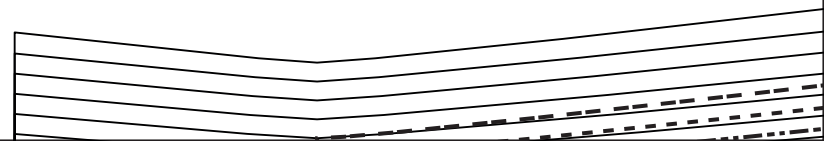
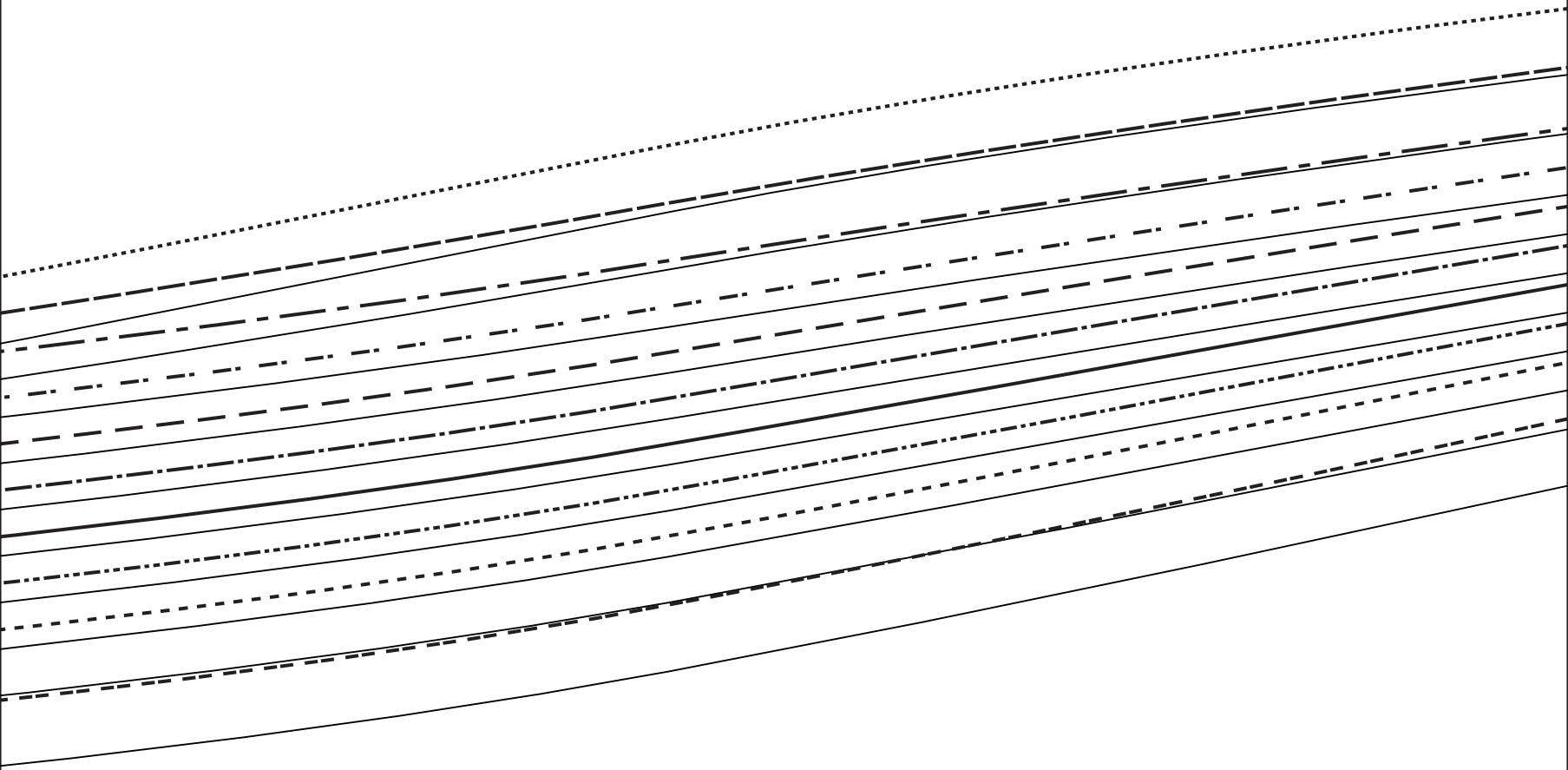

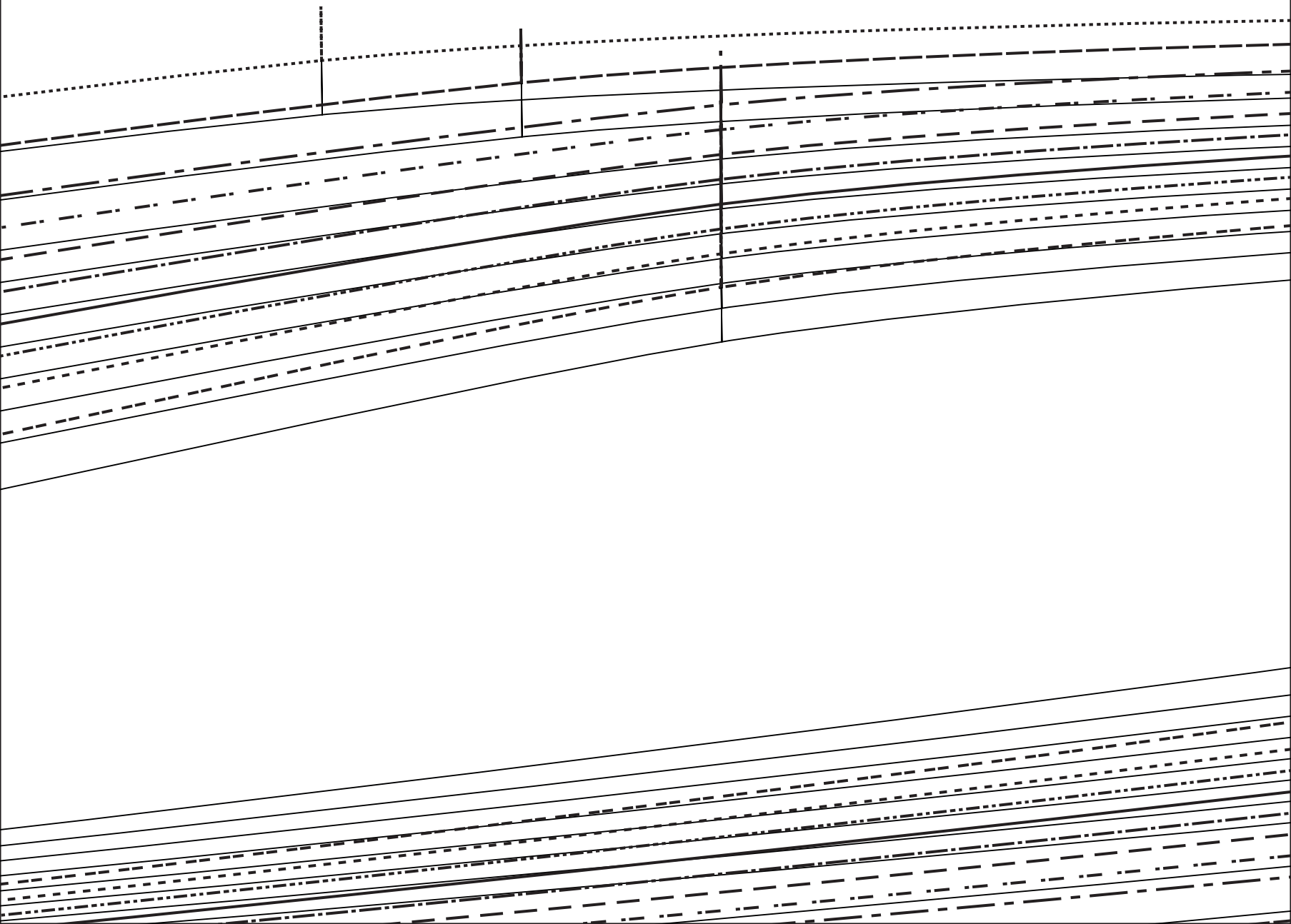

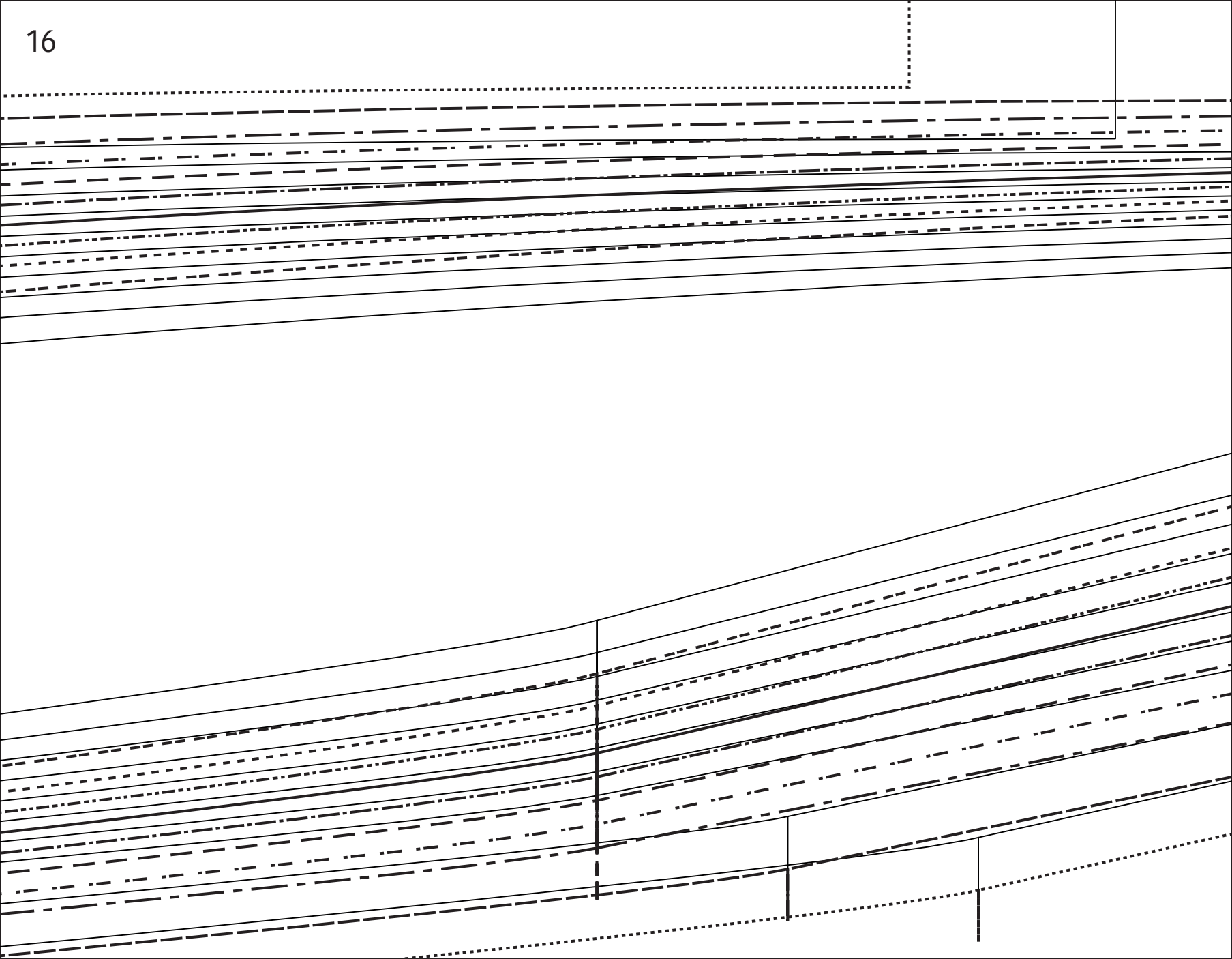

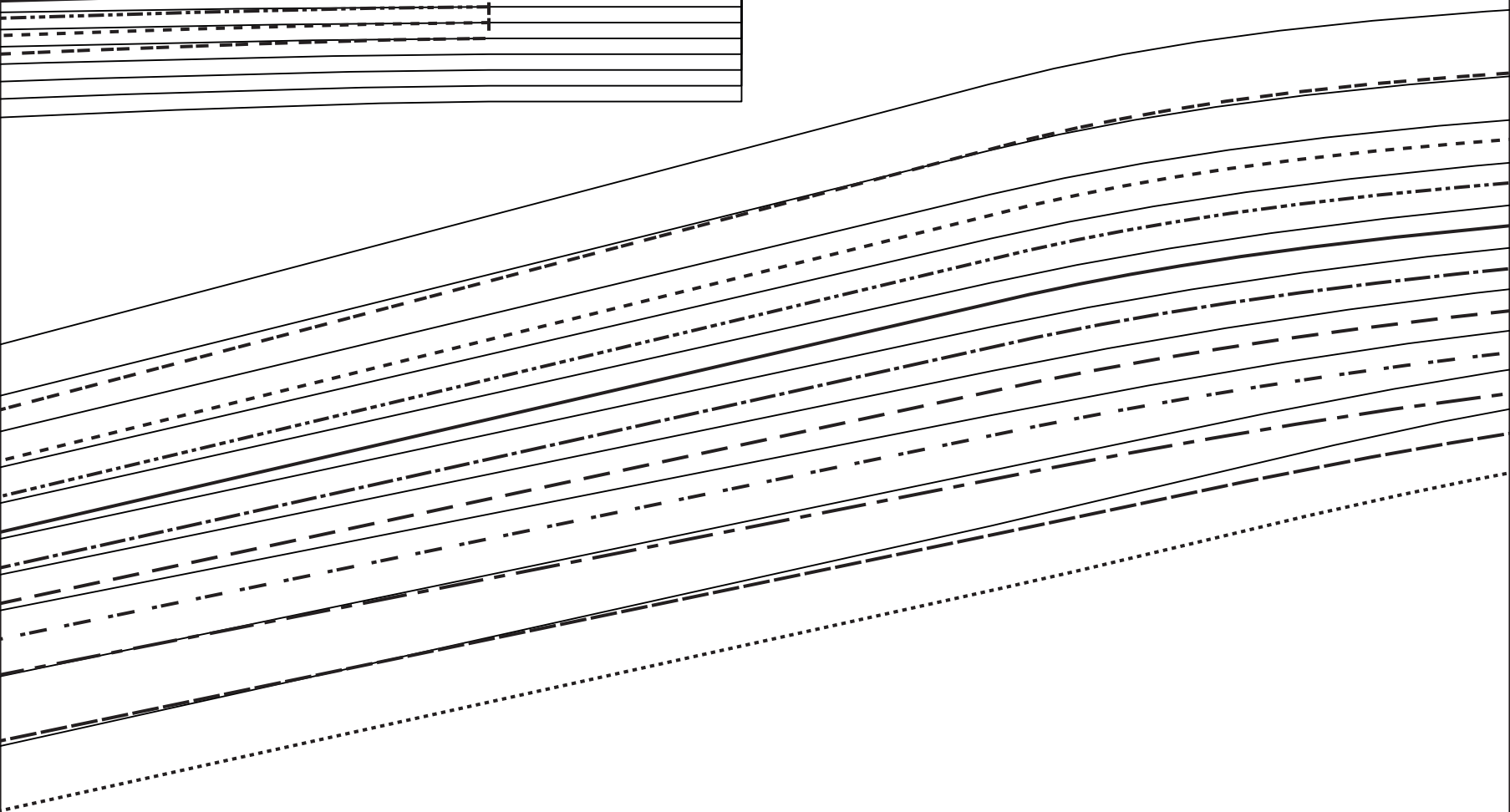
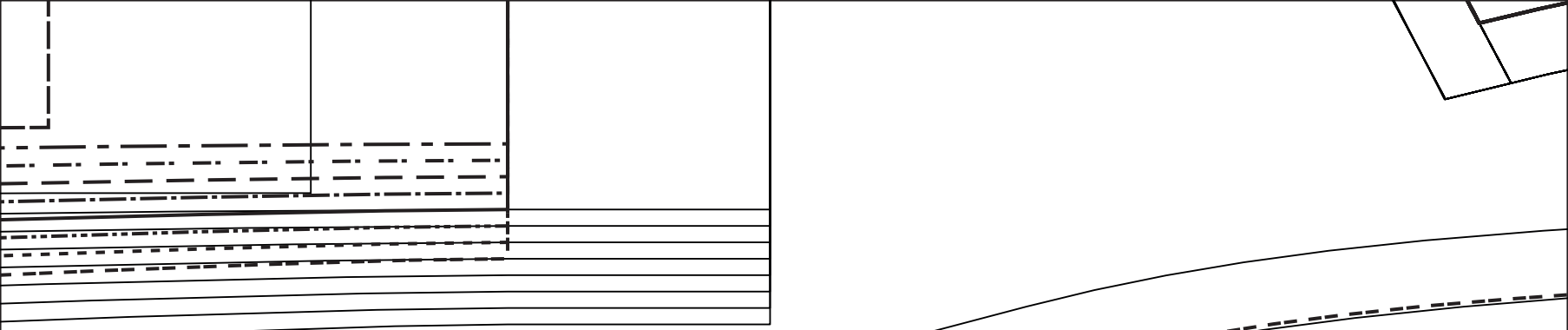

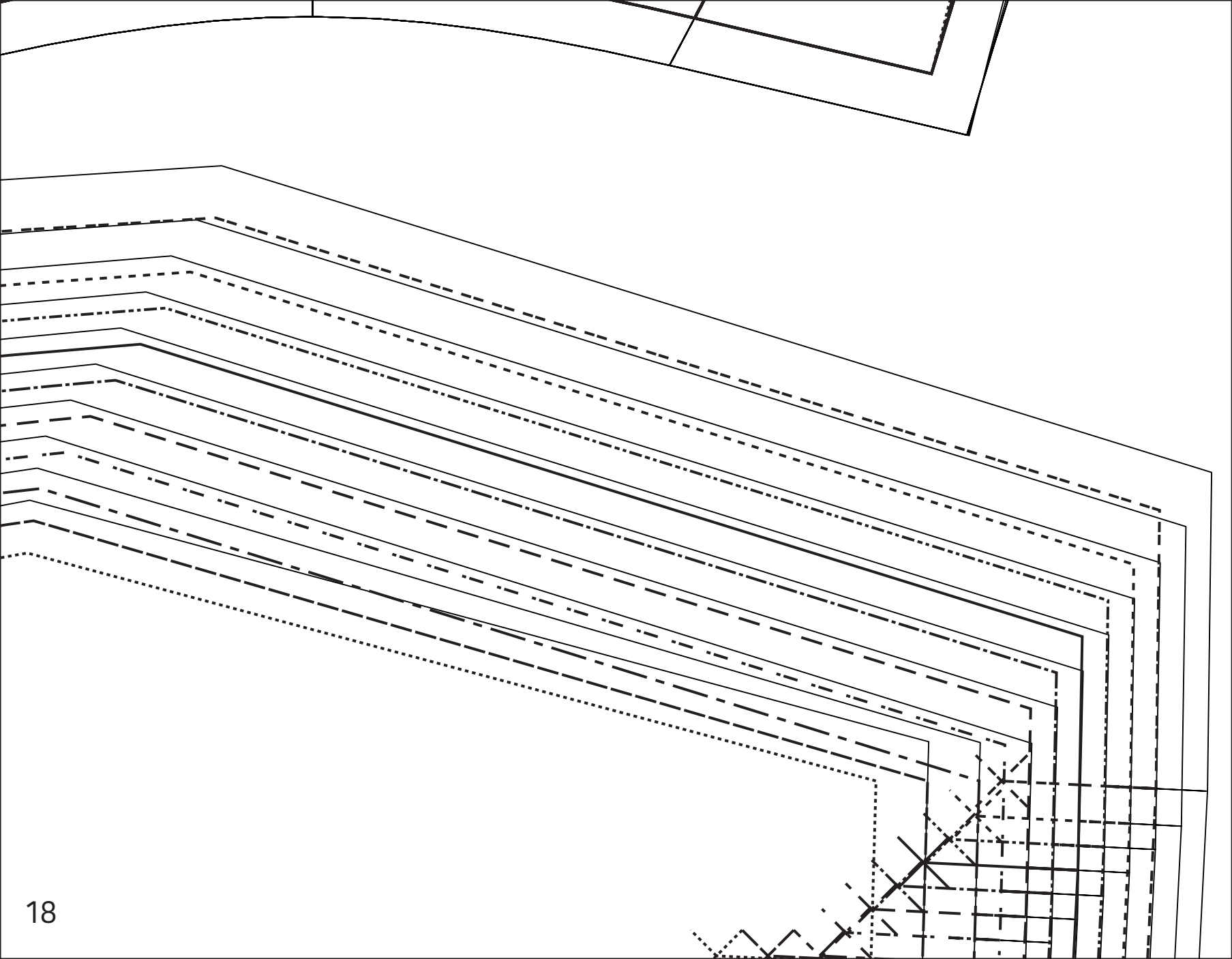

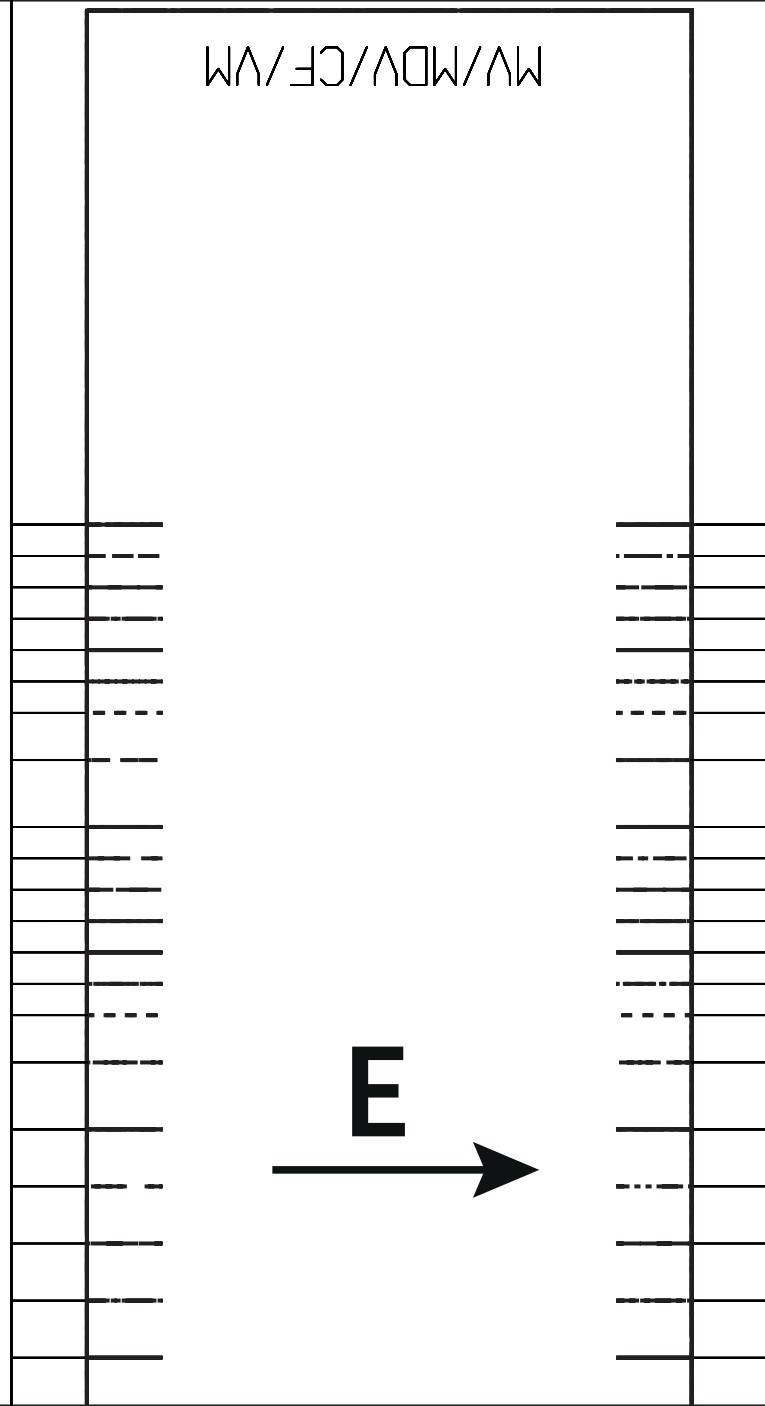
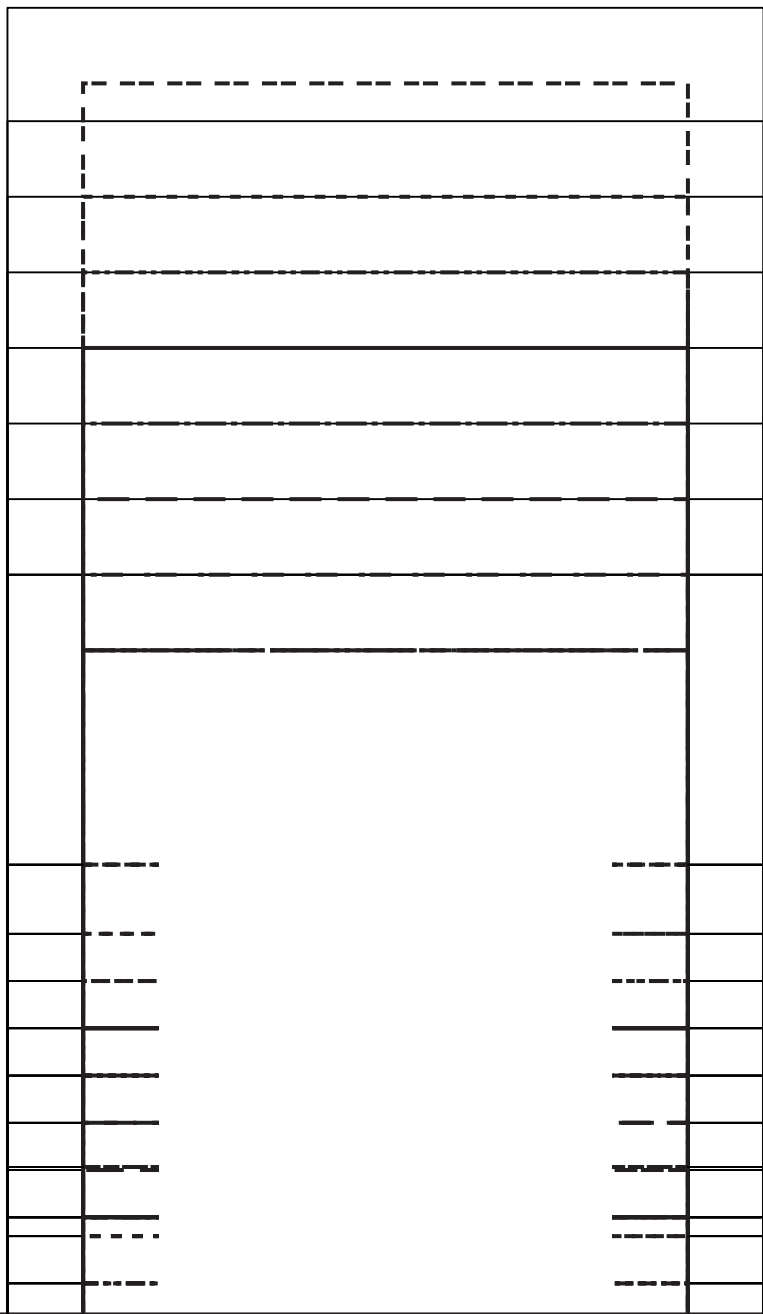

MV/MDV/CF/YM

20

NS/SS/CC/NZ

NS/SS/CC/NZ

NS/SS/CC/NZ

NS/SS/CC/NZ

NS/SS/CC/NZ

NS/SS/CC/NZ

NS/SS/CC/NZ

NS/SS/CC/NZ

NS/SS/CC/NZ

NS/SS/CC/NZ

NS/SS/CC/NZ

NS/SS/CC/NZ

NS/SS/CC/NZ

NS/SS/CC/NZ

NS/SS/CC/NZ

NS/SS/CC/NZ

NS/SS/CC/NZ

NS/SS/CC/NZ

NS/SS/CC/NZ

NS/SS/CC/NZ

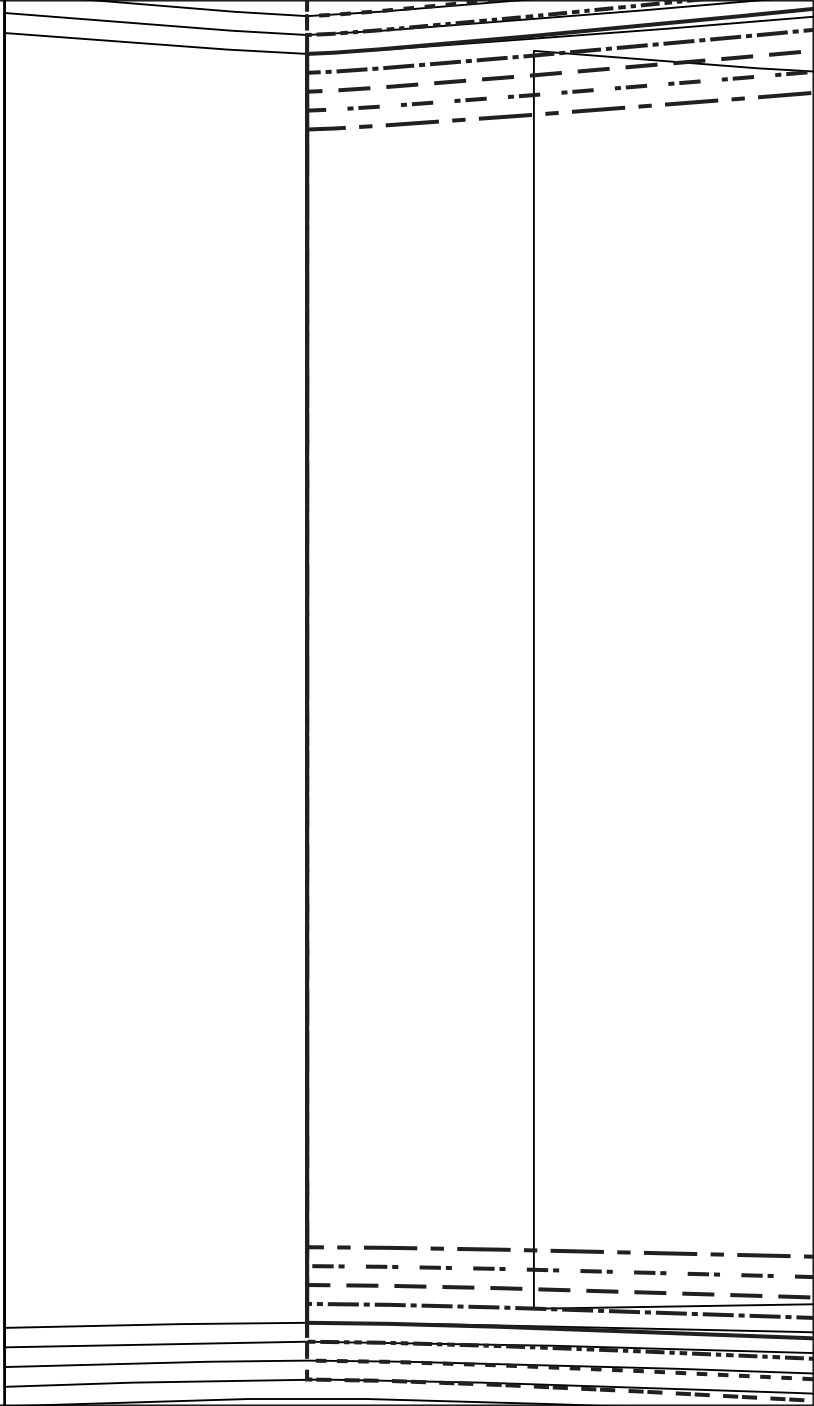

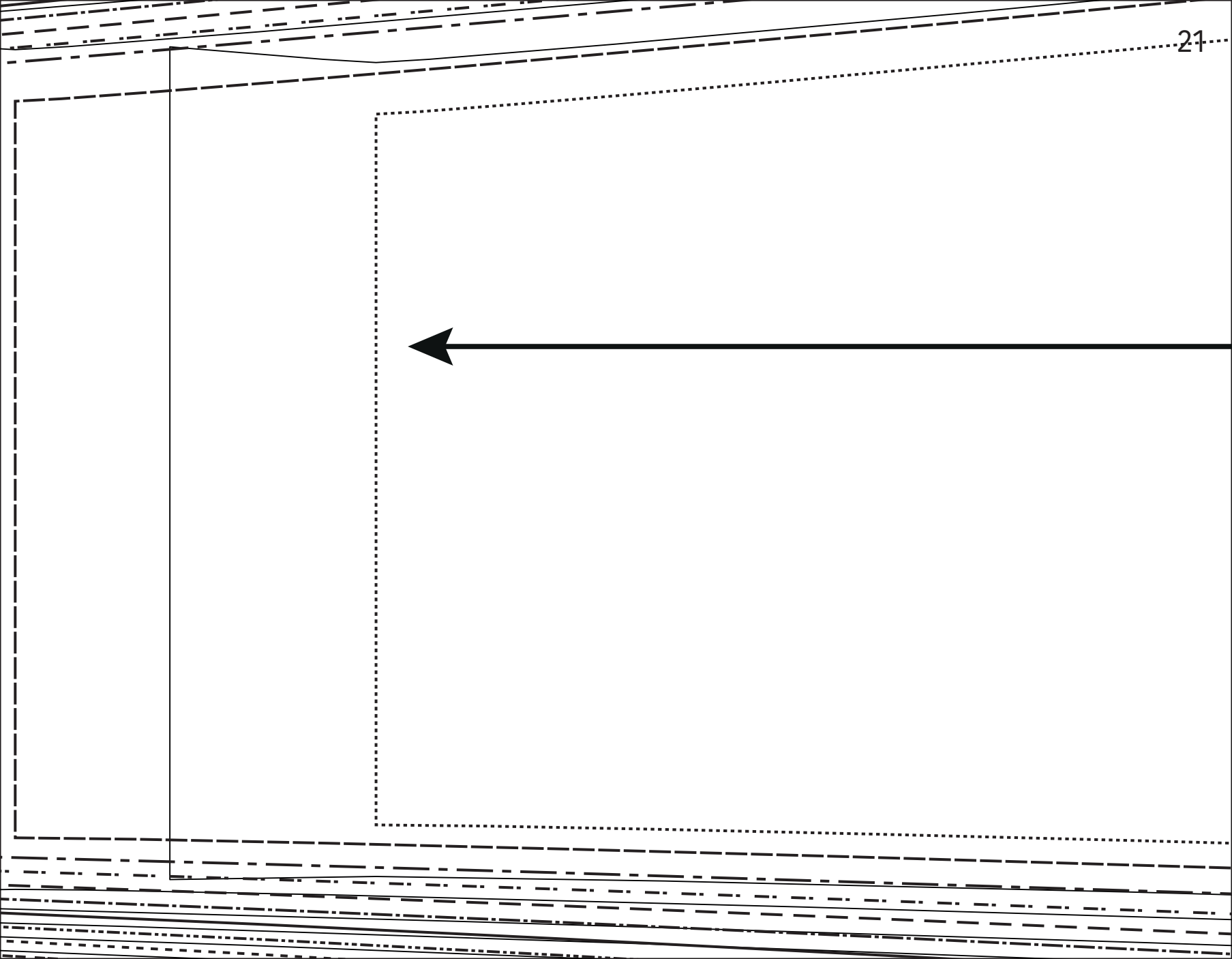

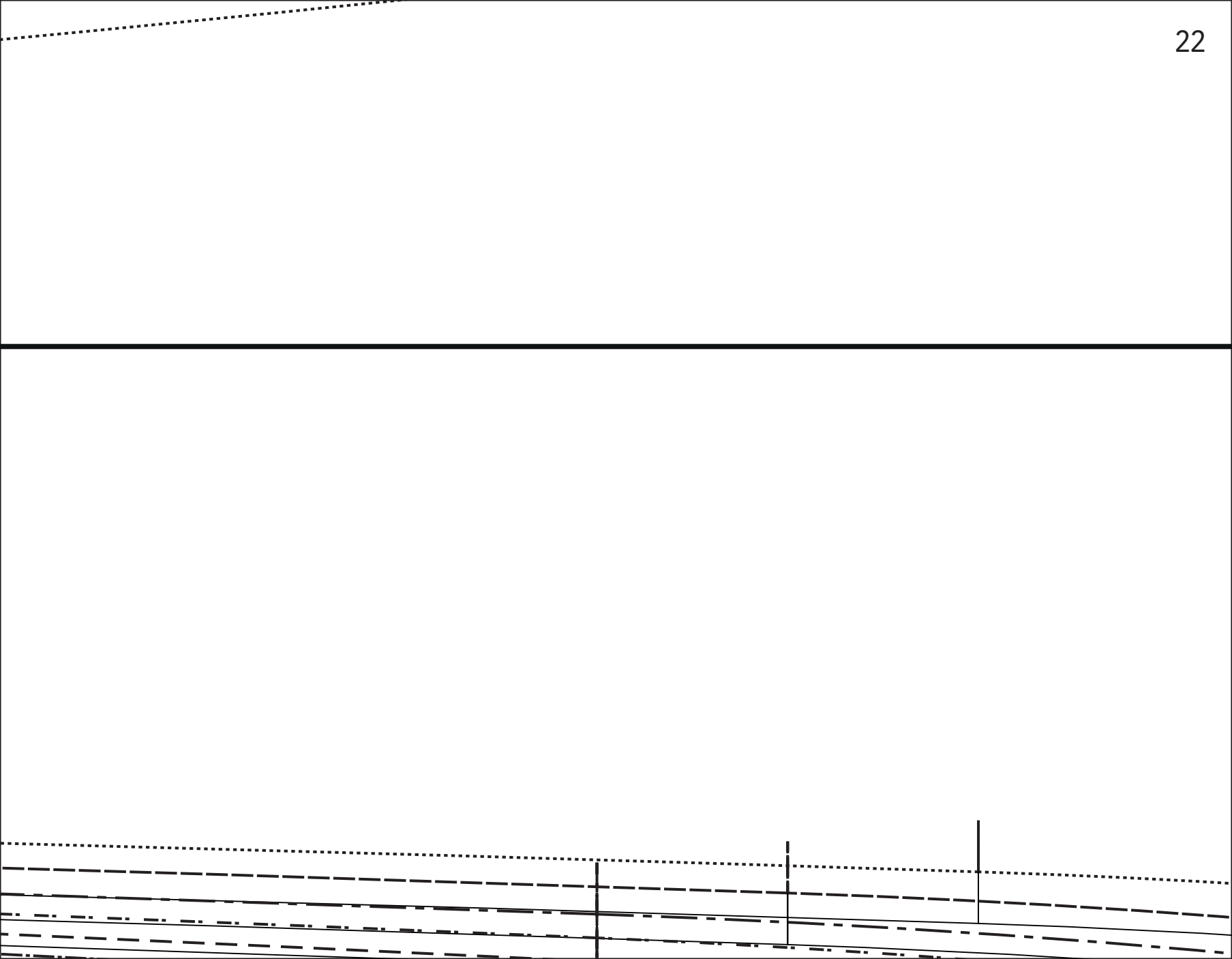

V



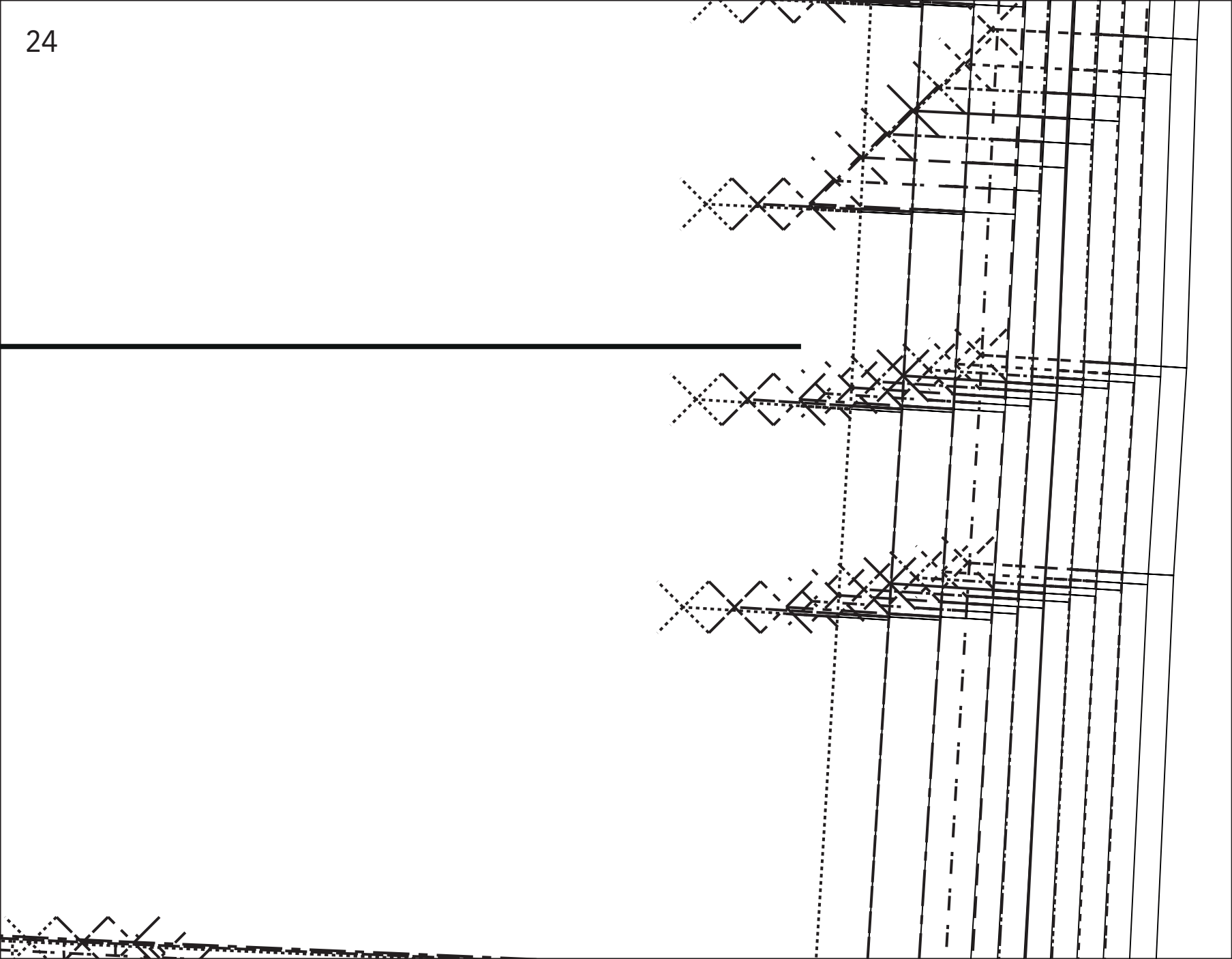

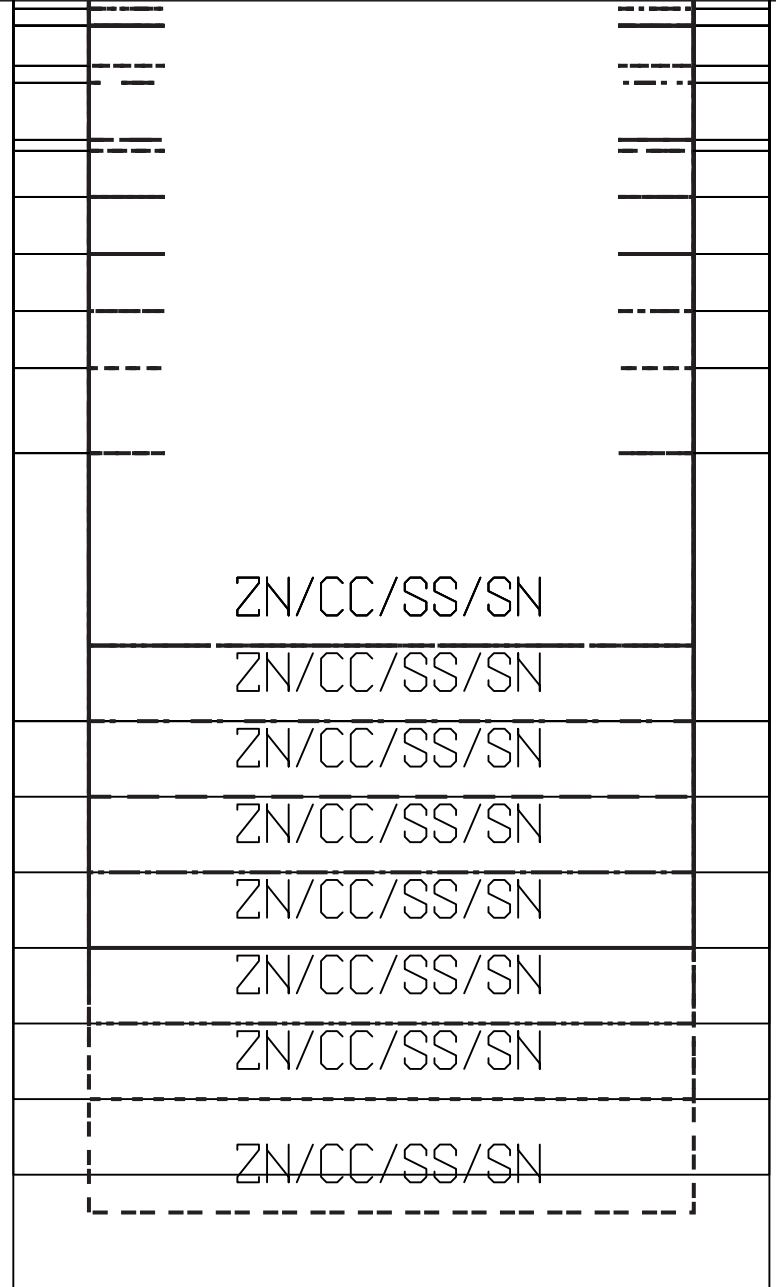
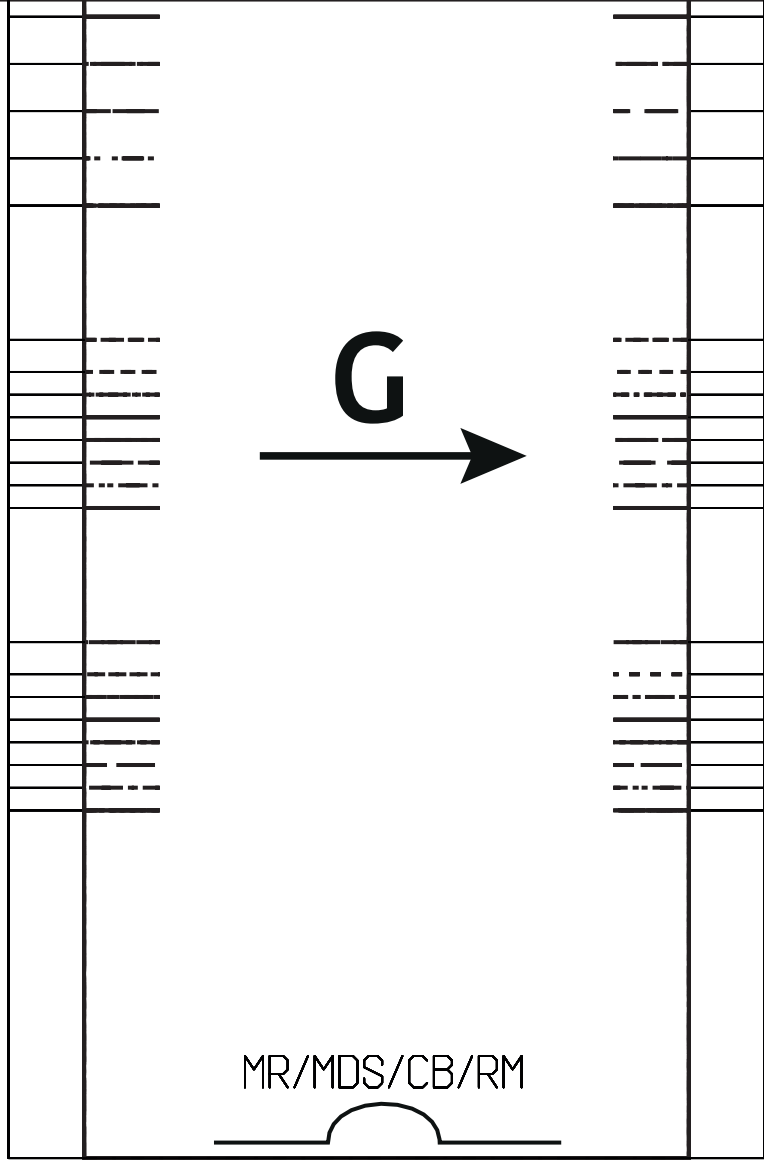

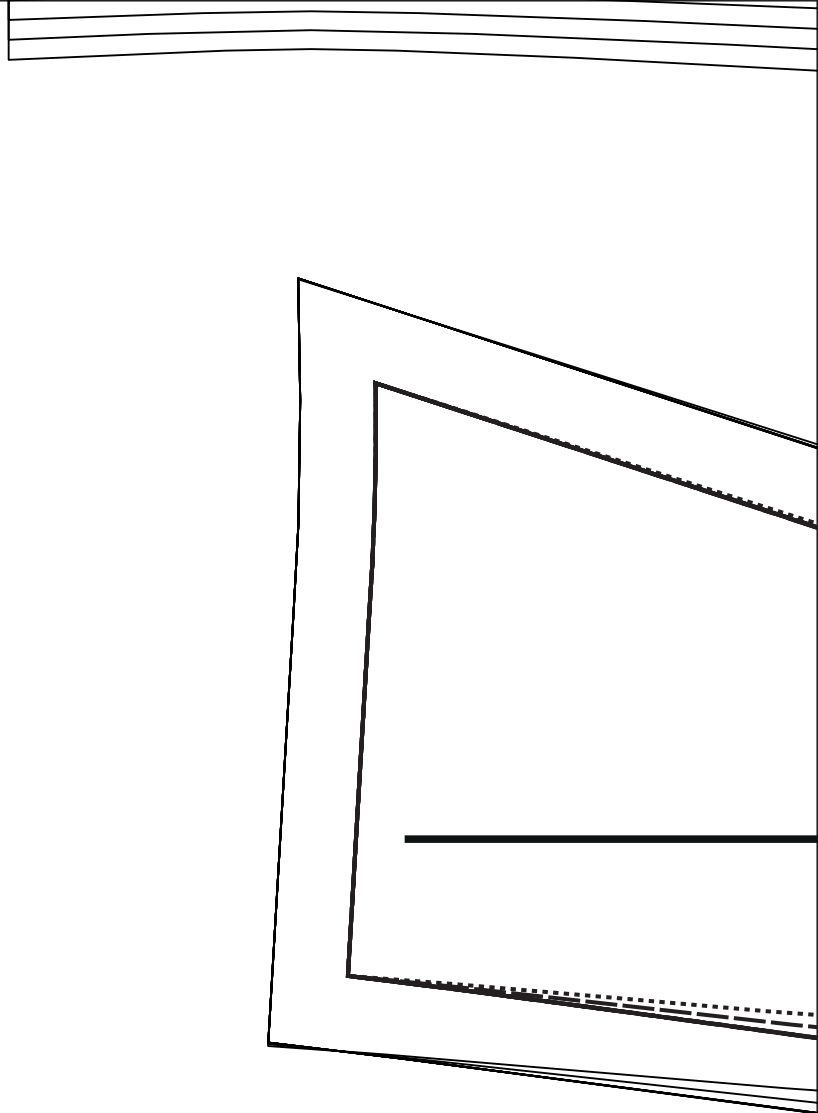
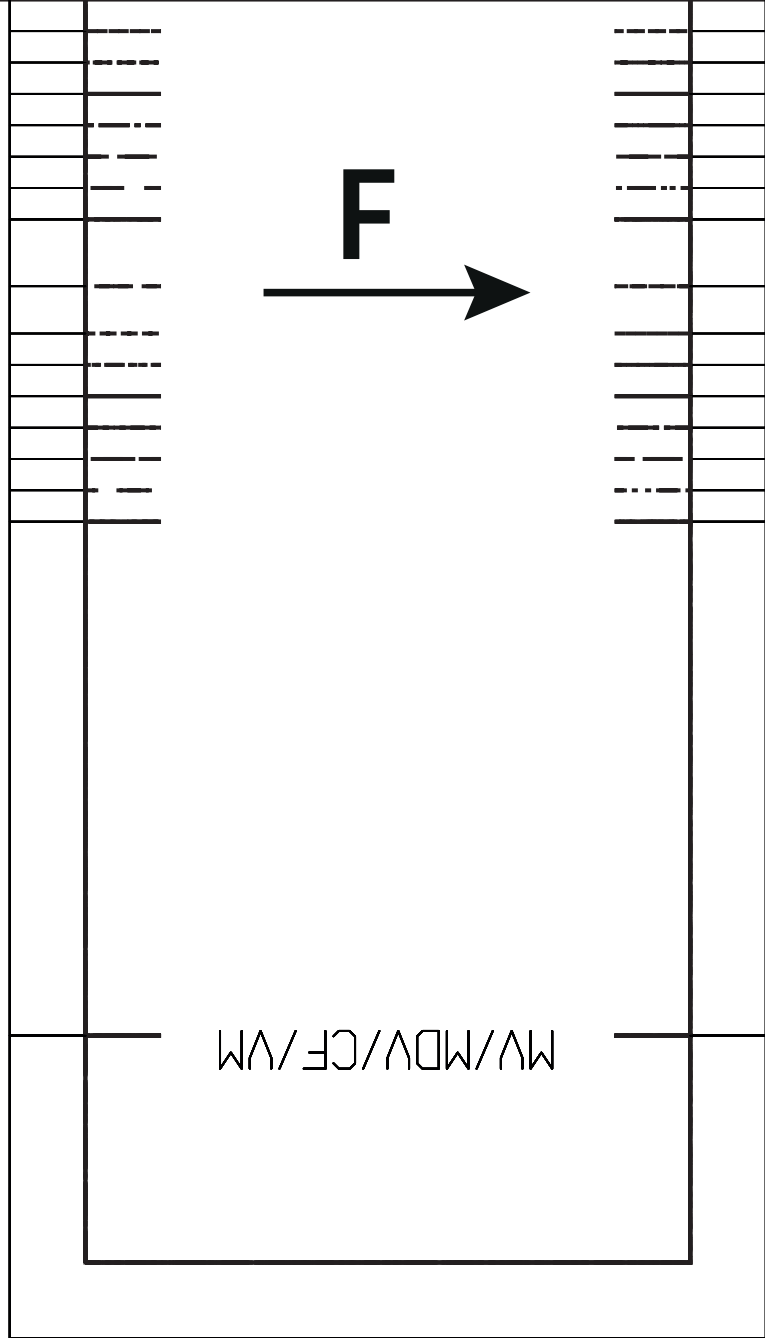

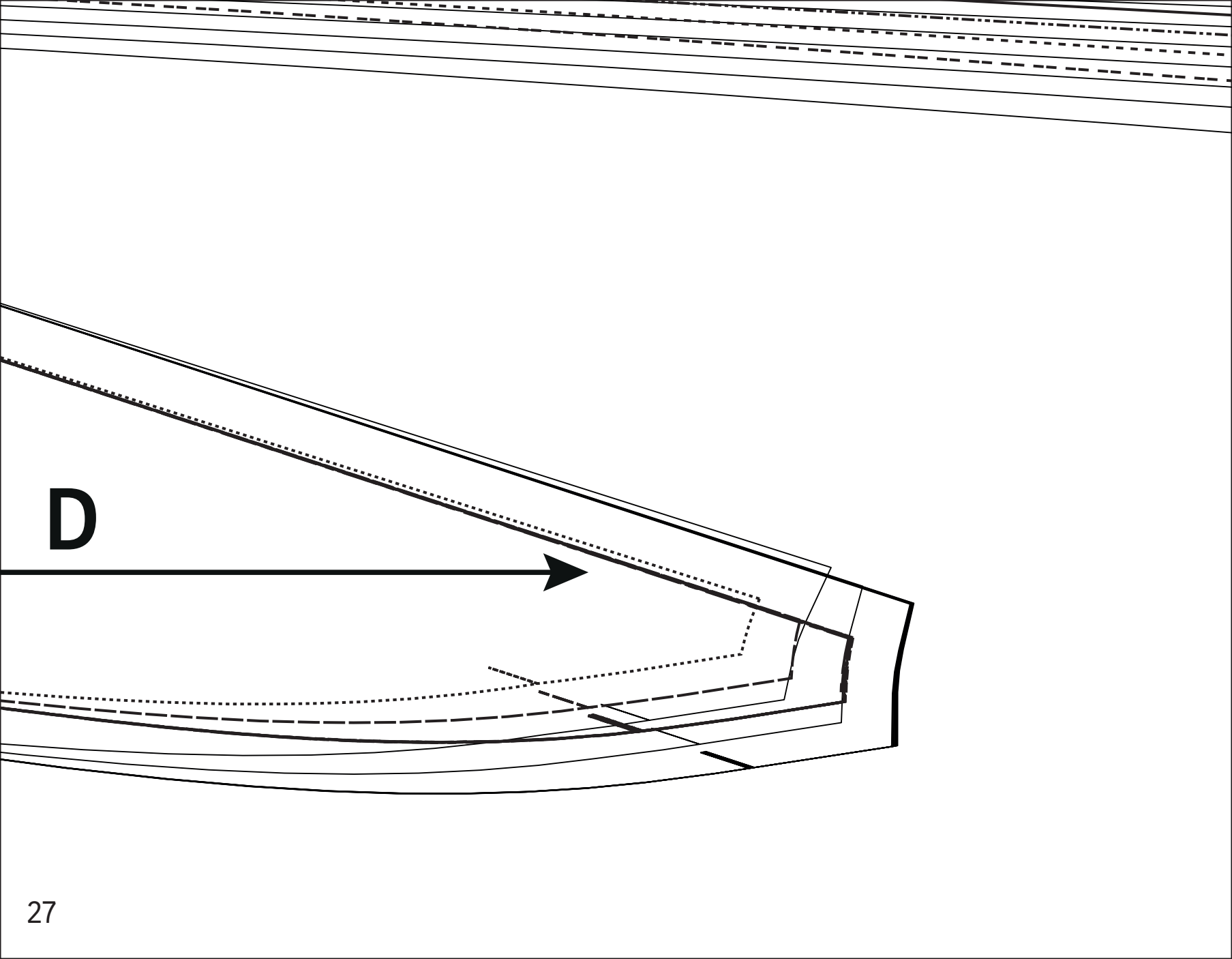

D

