

Patroonschema / Schéma du Patron / Pattern Diagram /
Übersichtsplan zum Zusammenkleben

1	2	3	4	5	6	7
8	9	10	11	12	13	14
15	16	17	18	19	20	21
22	23	24	25	26	27	28
29	30	31	32	33	34	35
36	37	38	39	40	41	

Lize

Jurk / Robe /
Dress / Kleid

Patroondelen / Pièces du patron /
Pattern pieces / Schnittteile:

A voorpand / devant / front panel /
Vorderteil

B rugpand / dos / back panel /
Rückenteil

C mouw / manche / sleeve / Ärmel

D halsboord / bord encolure / collar /
Halsbündchen

Controlevierkant / Carré de controle
/ Test square / Kontrollquadrat

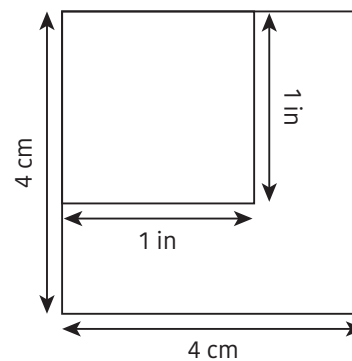

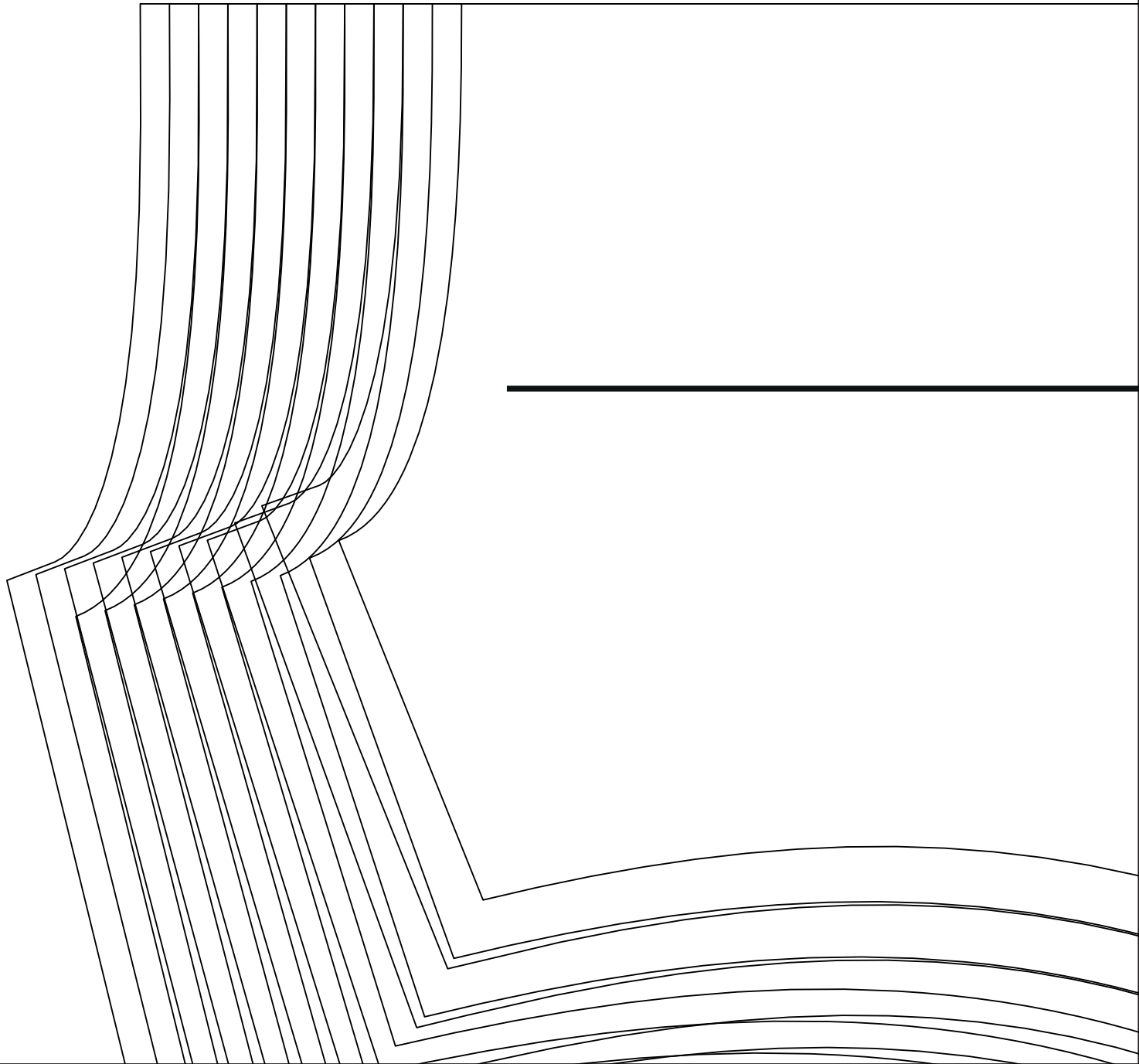

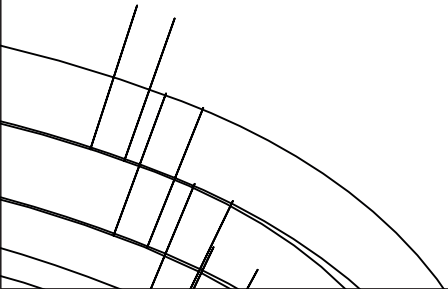



B

6



--	--	--	--	--	--

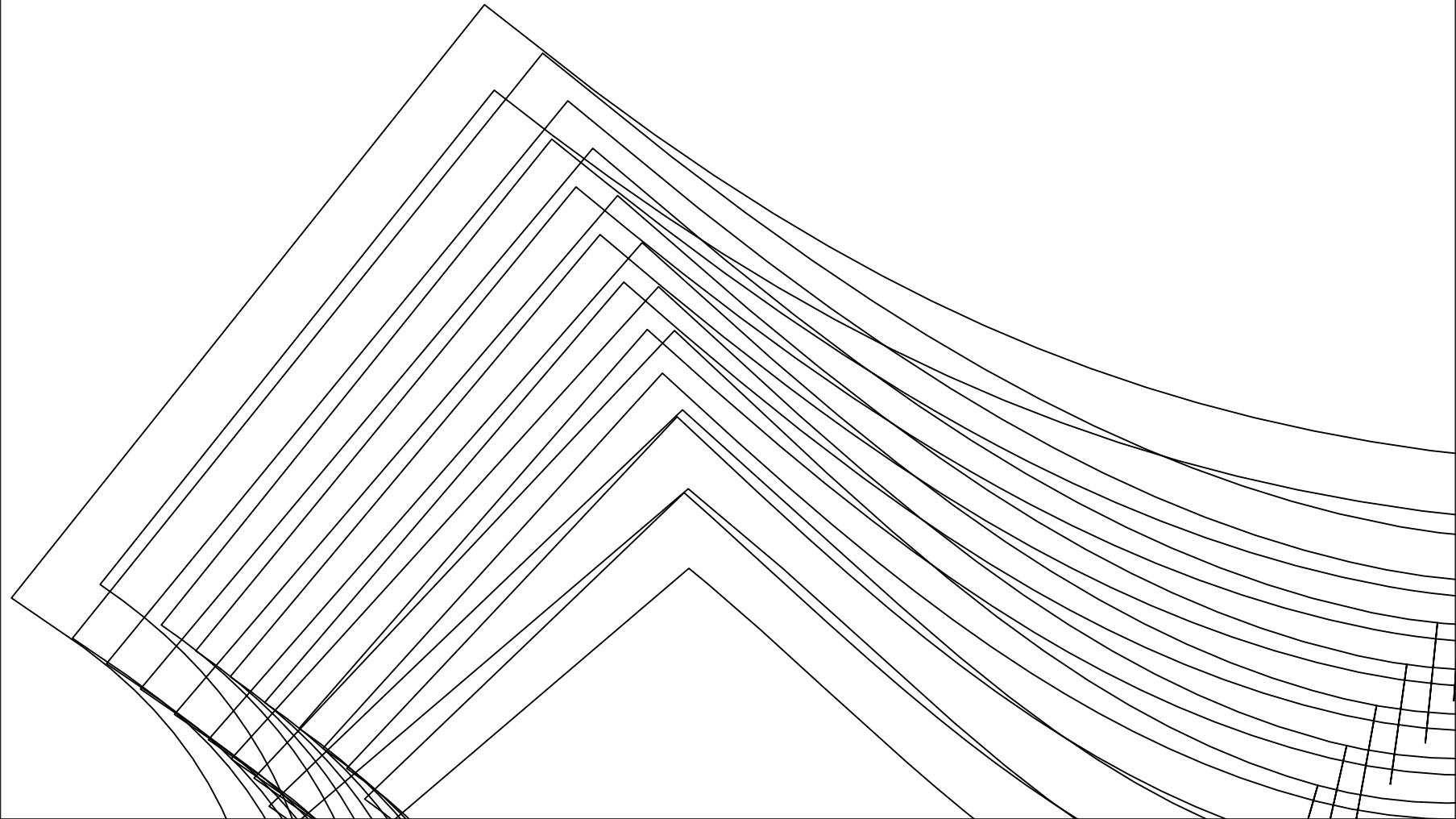

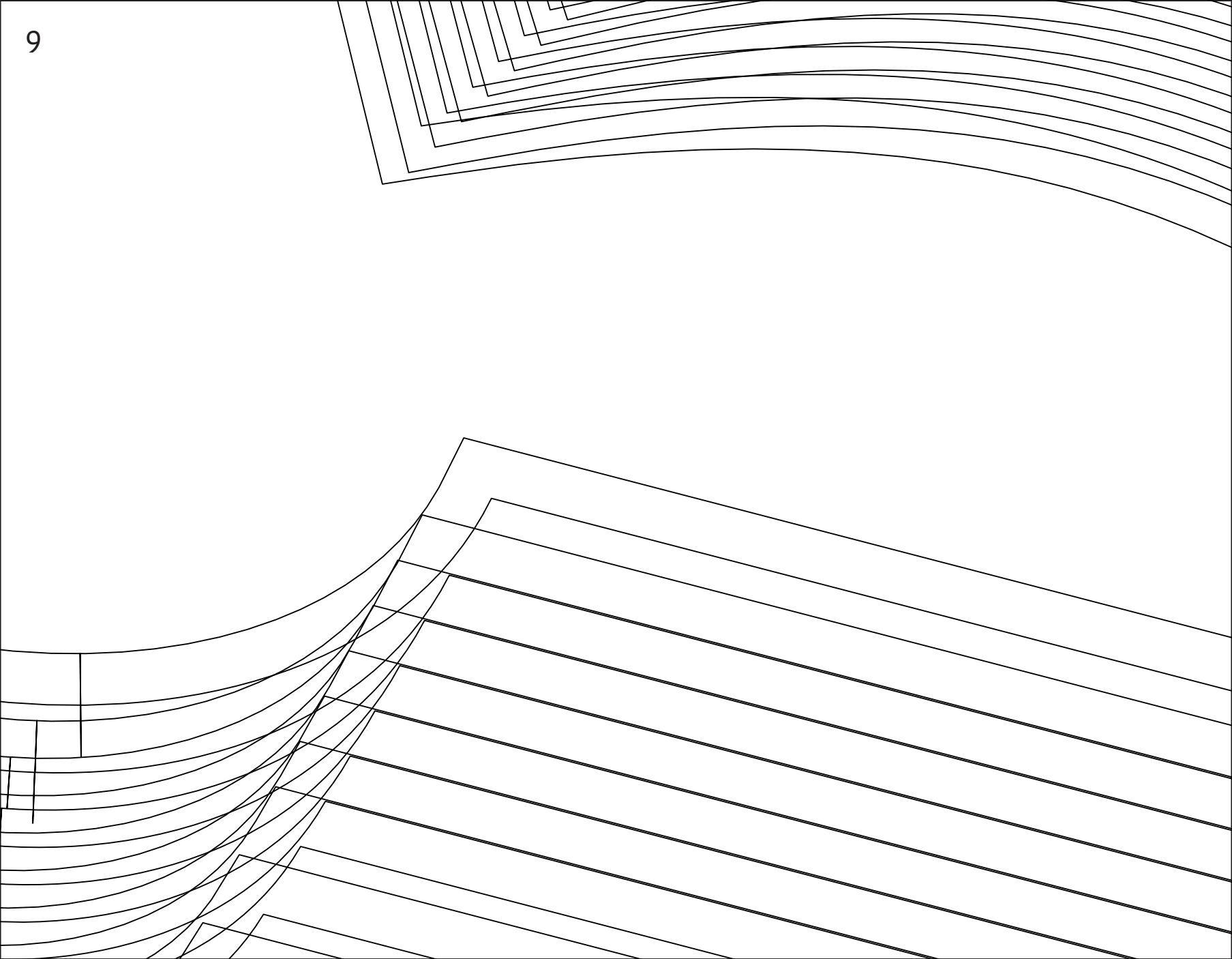

10

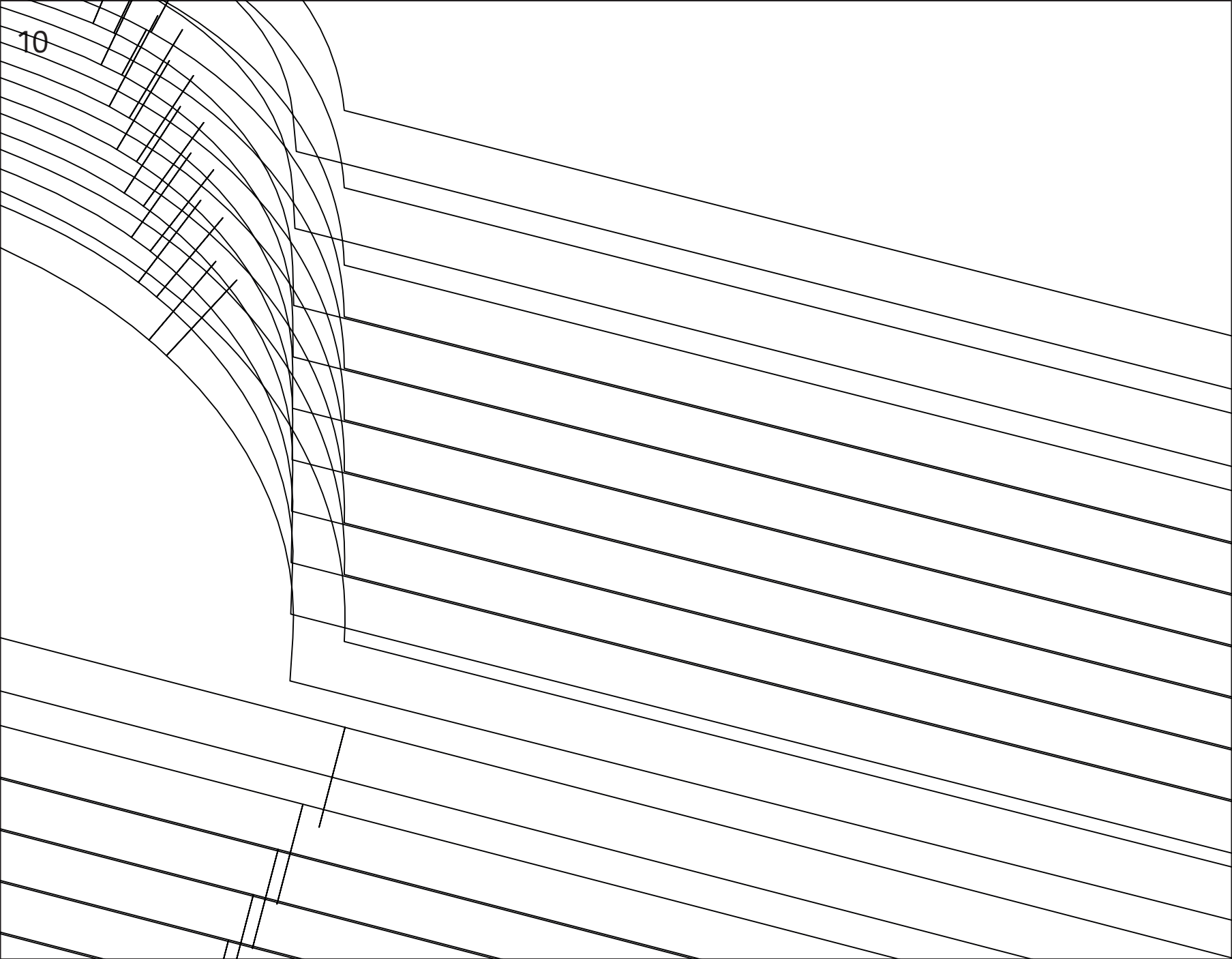

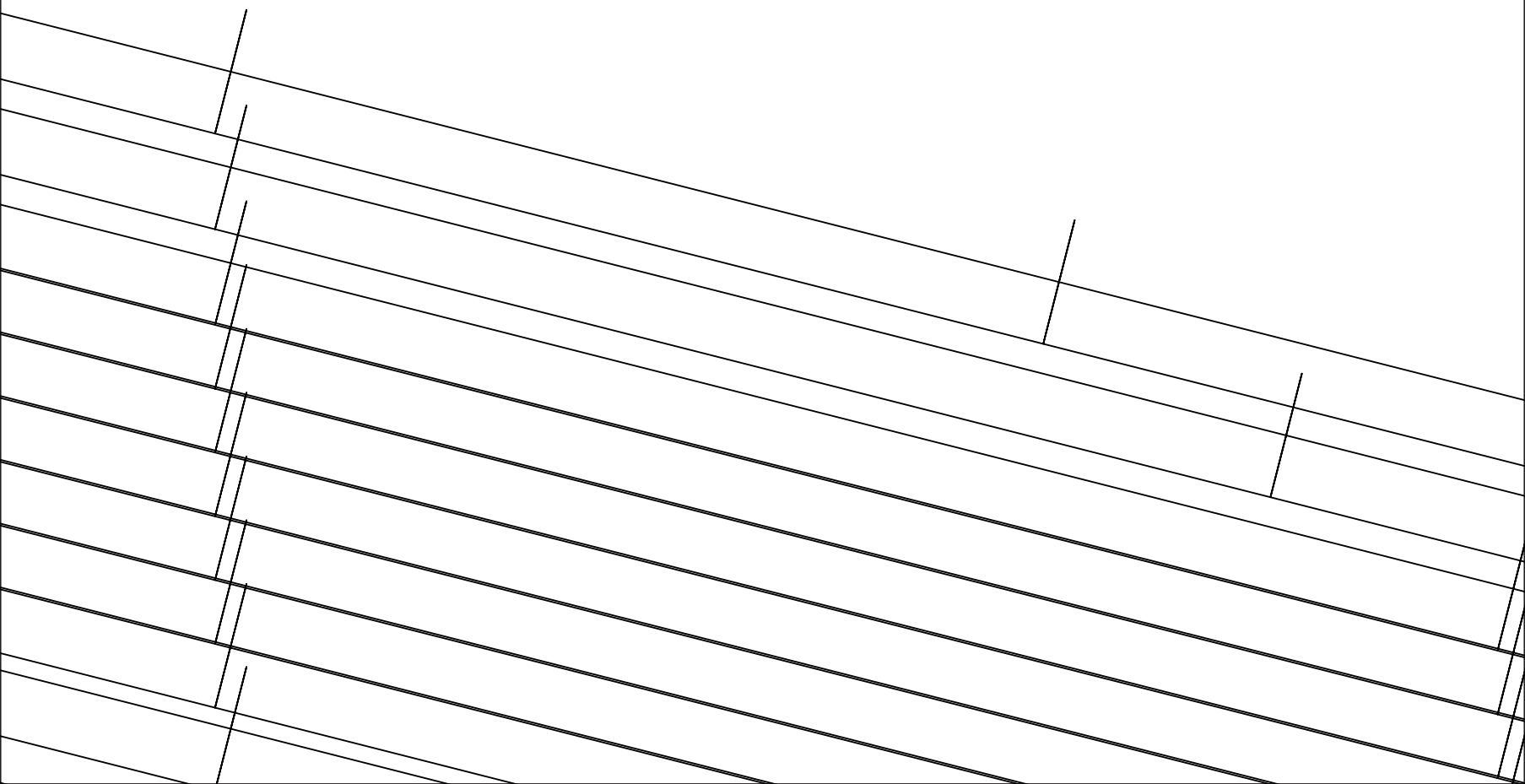

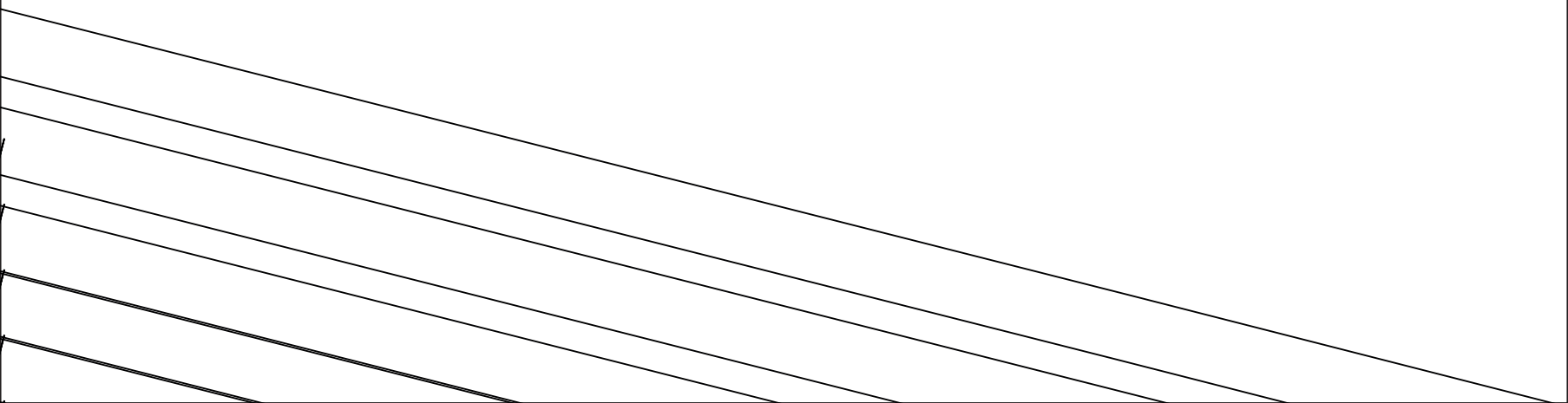

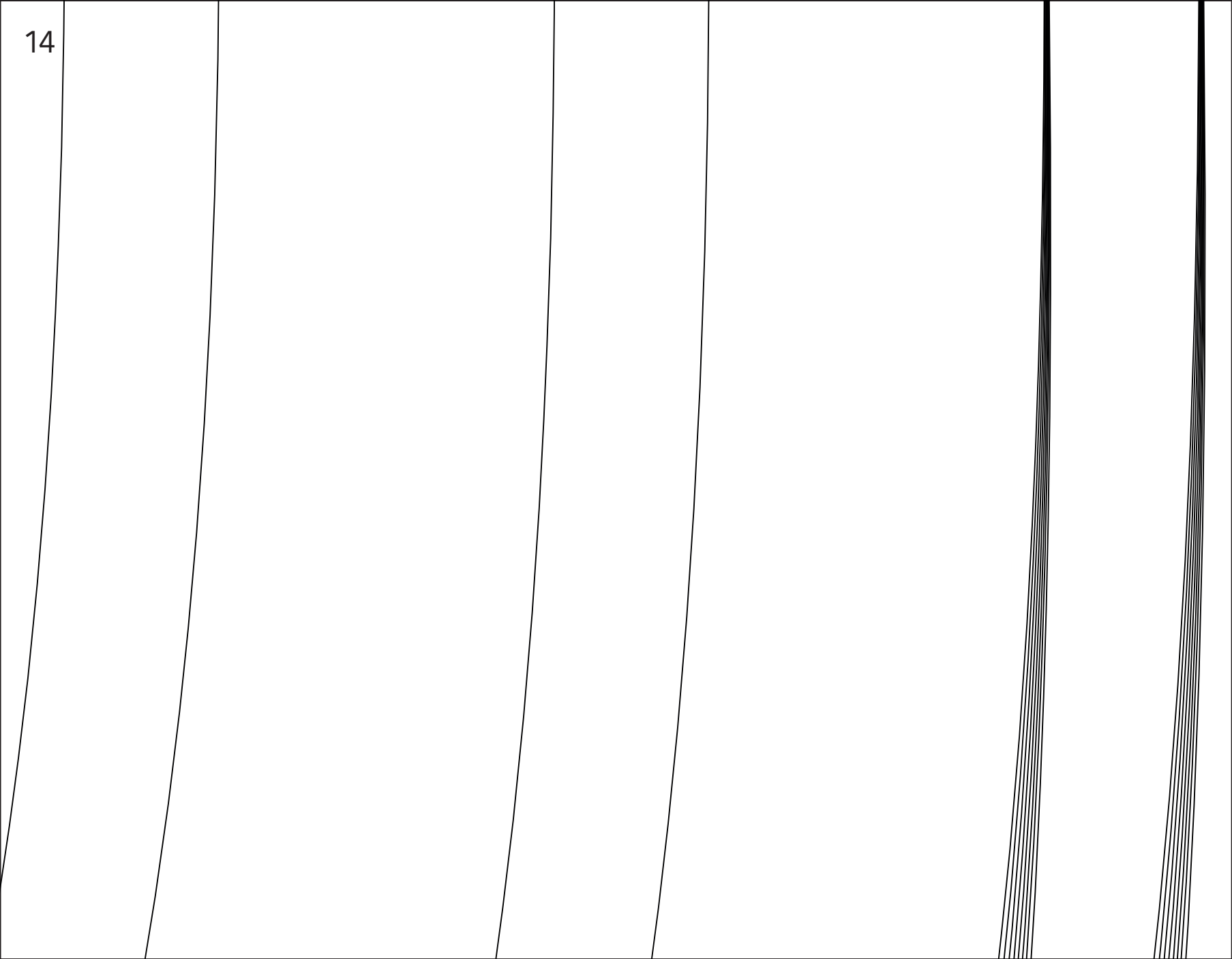

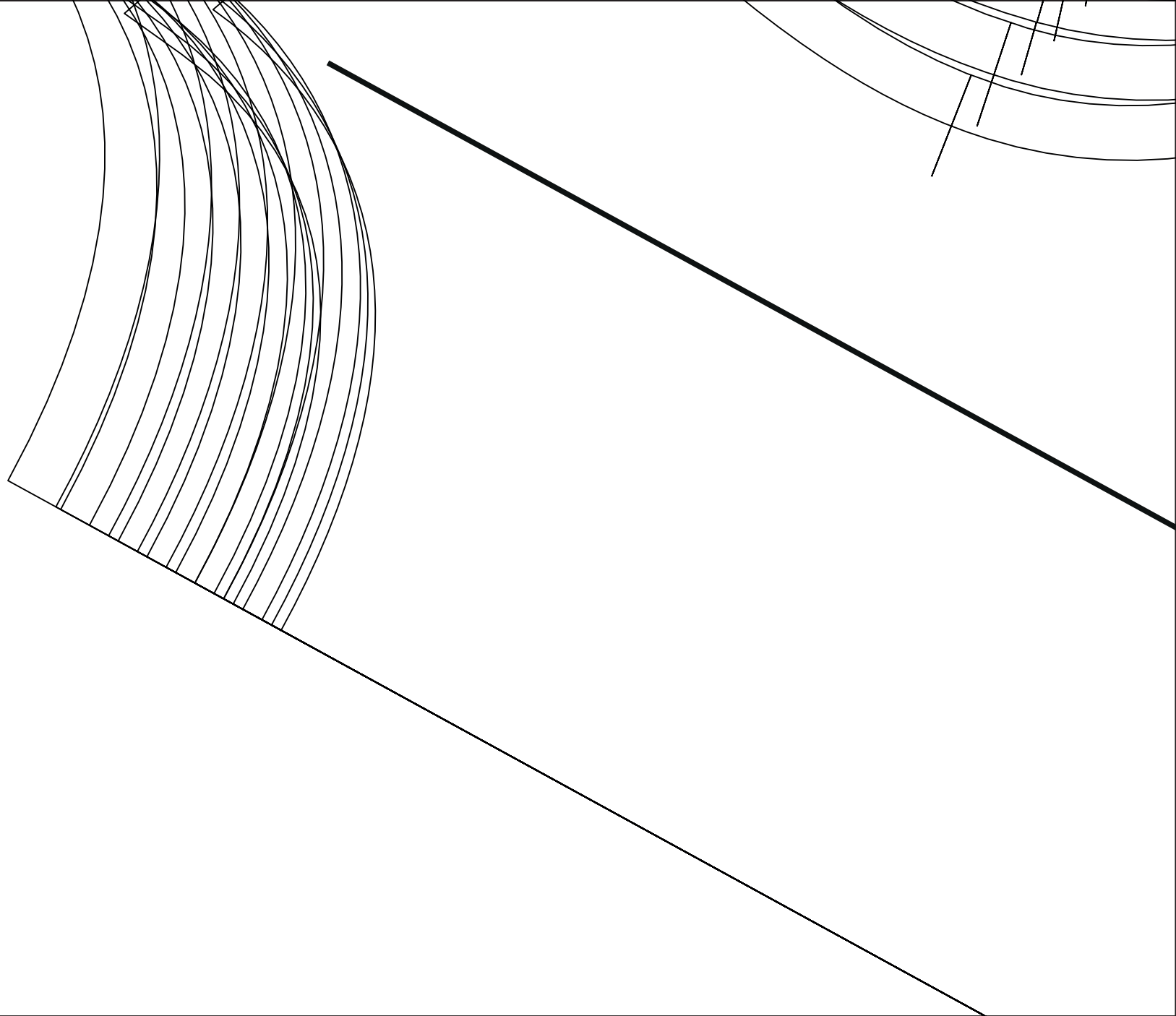

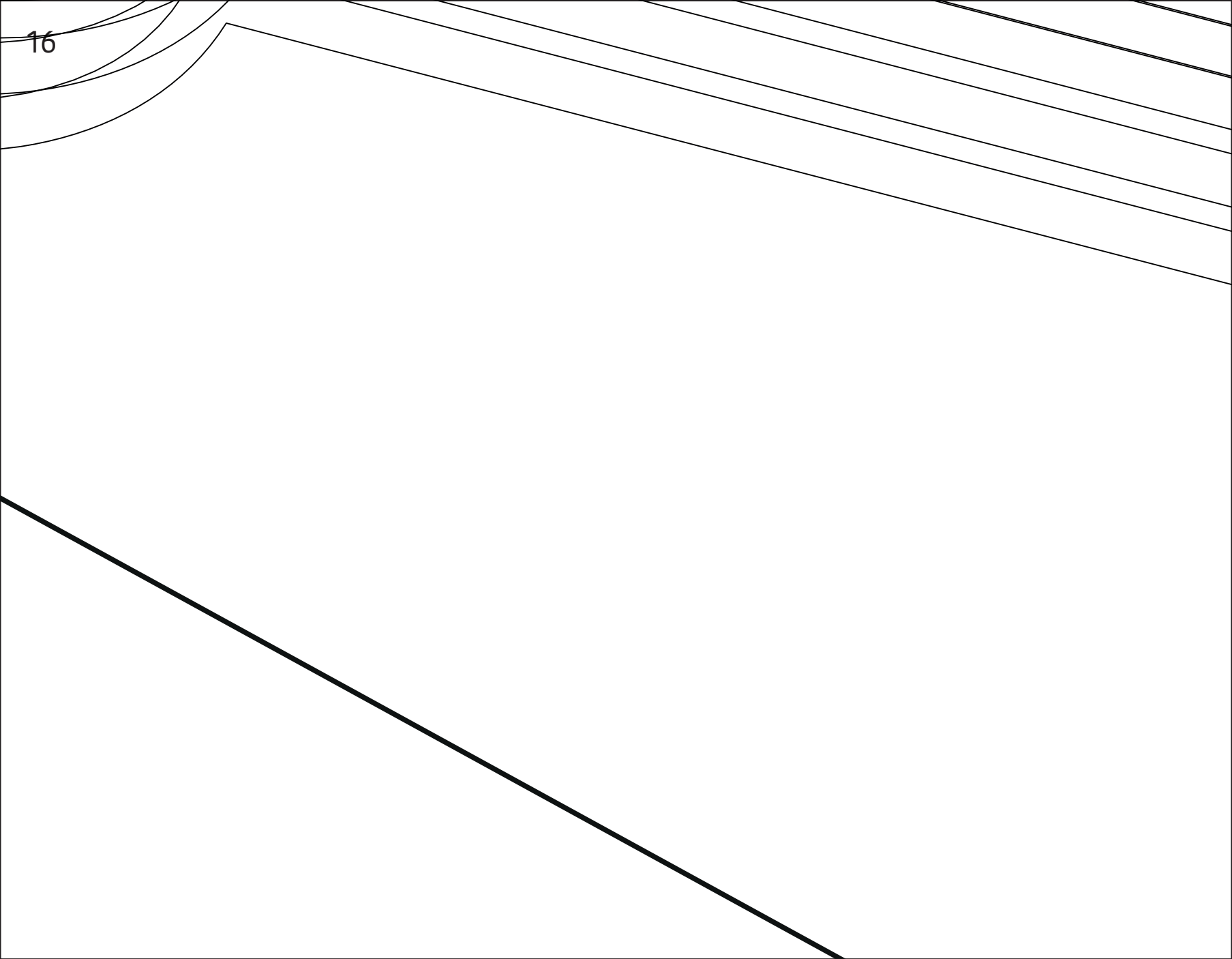

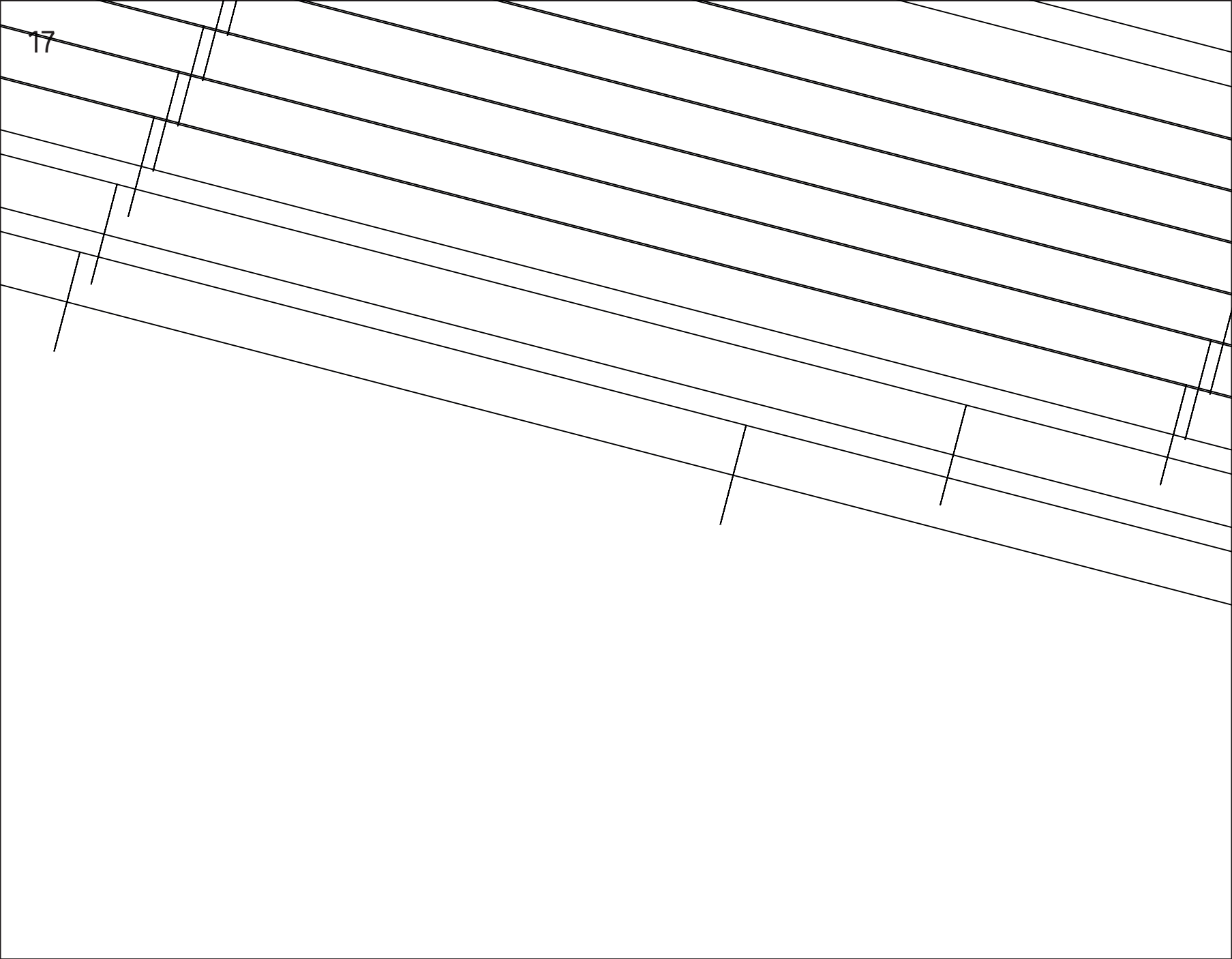

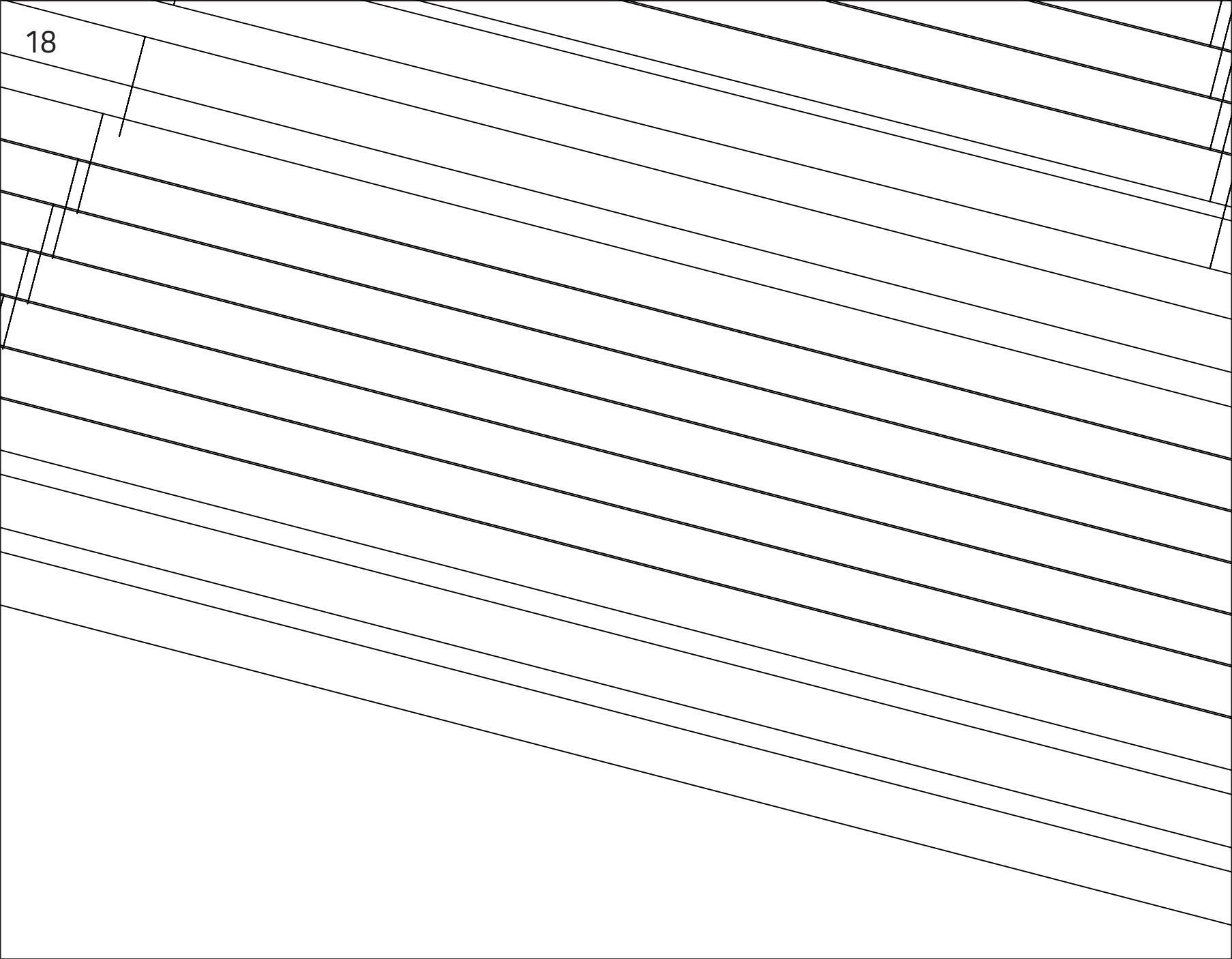

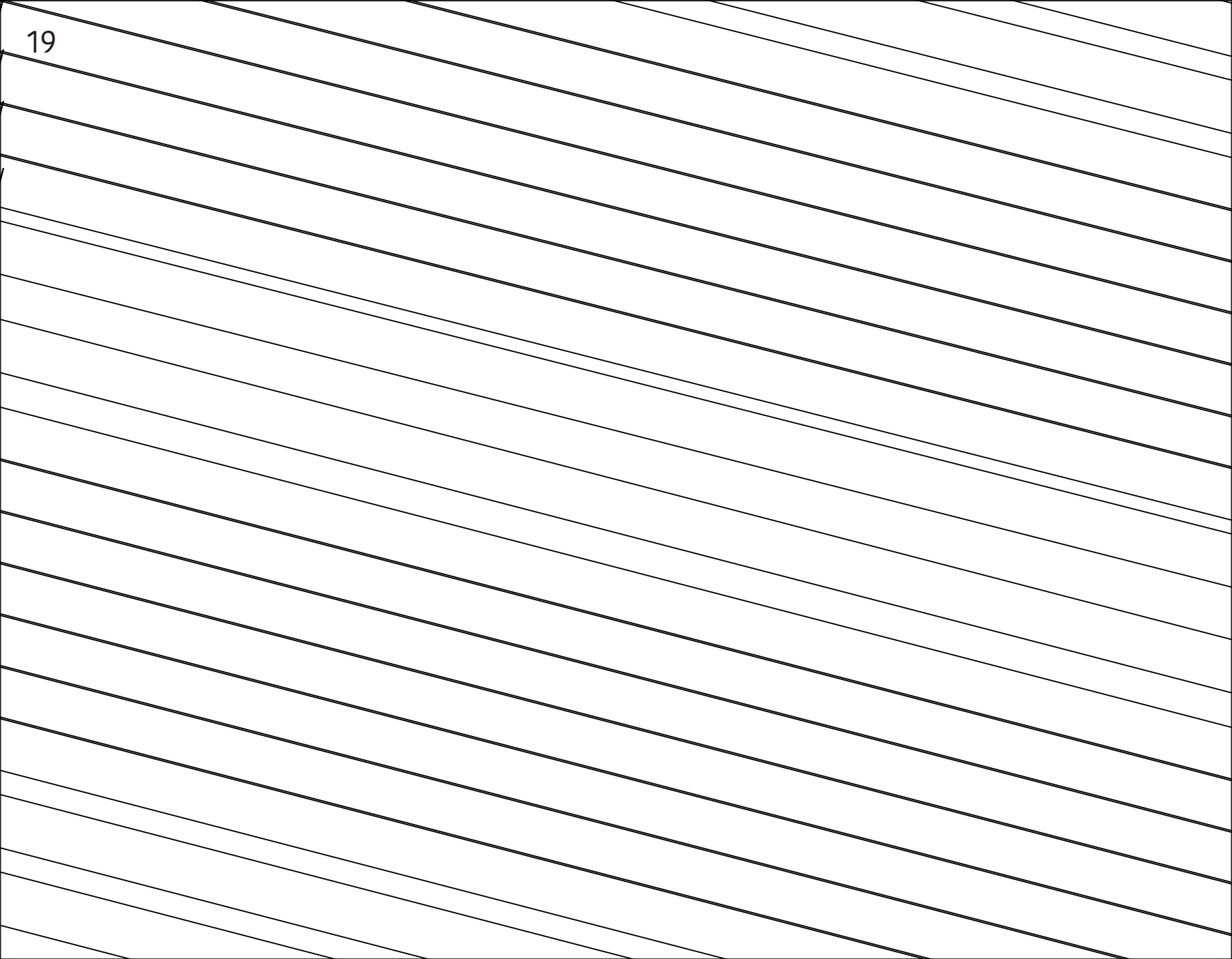

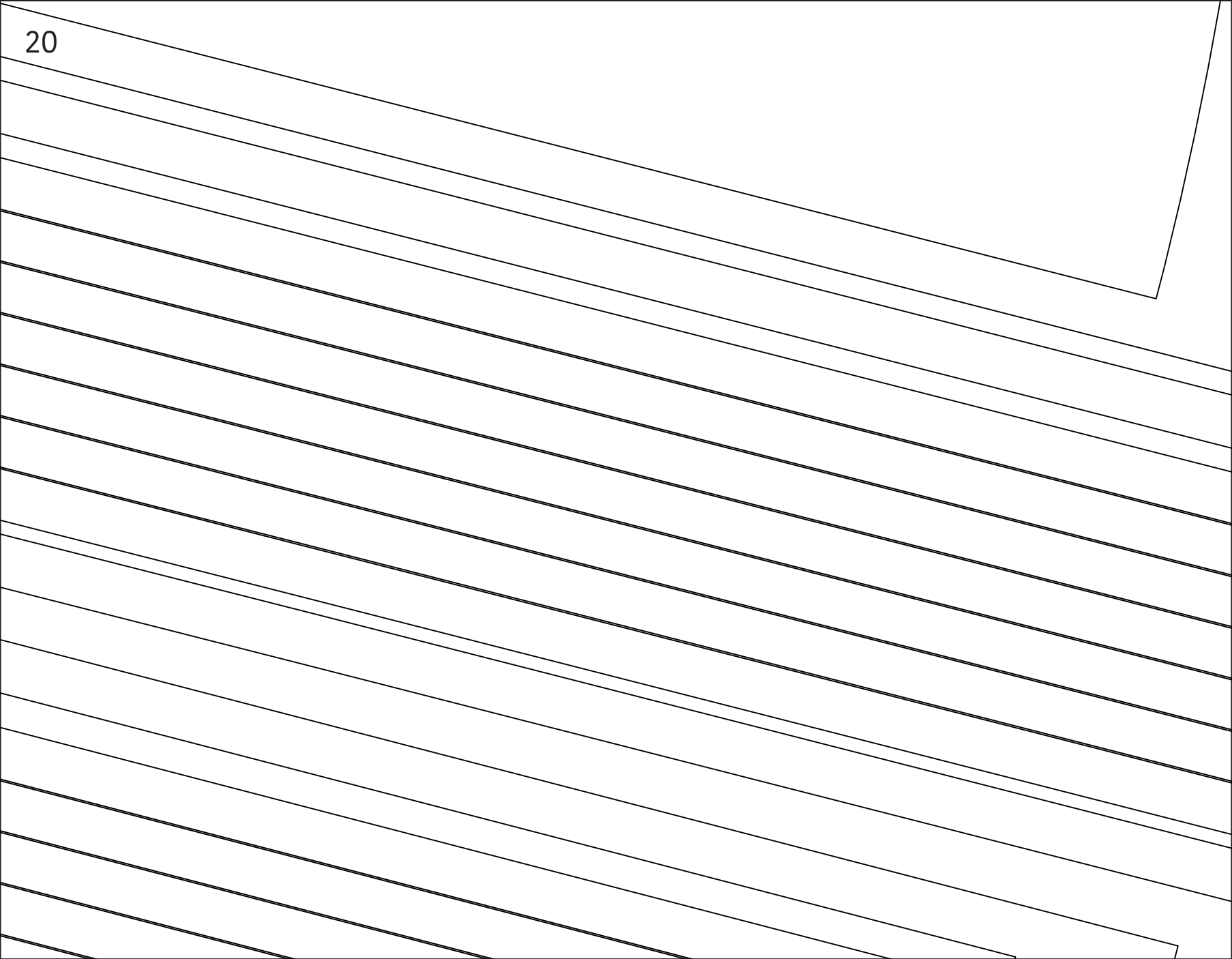

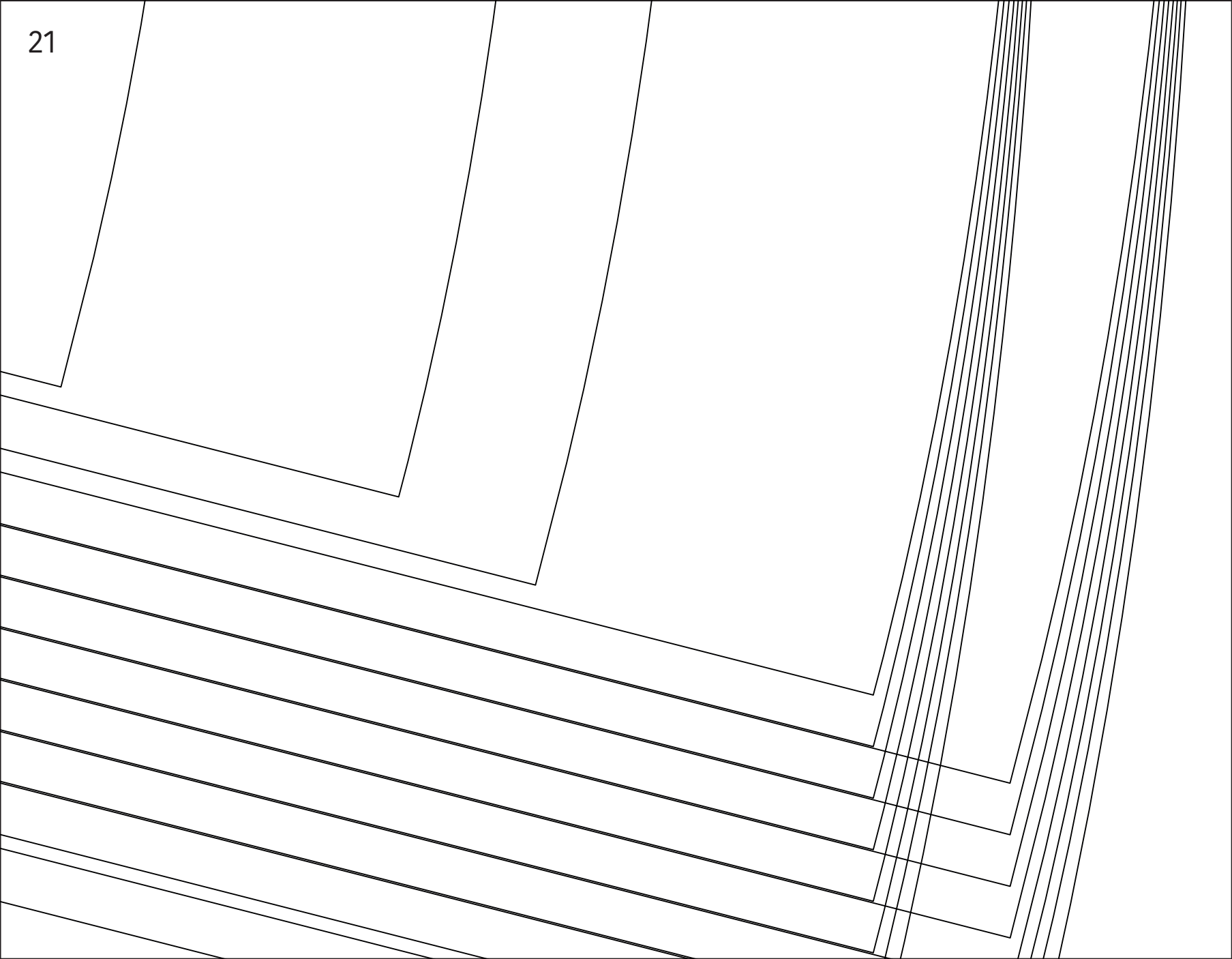

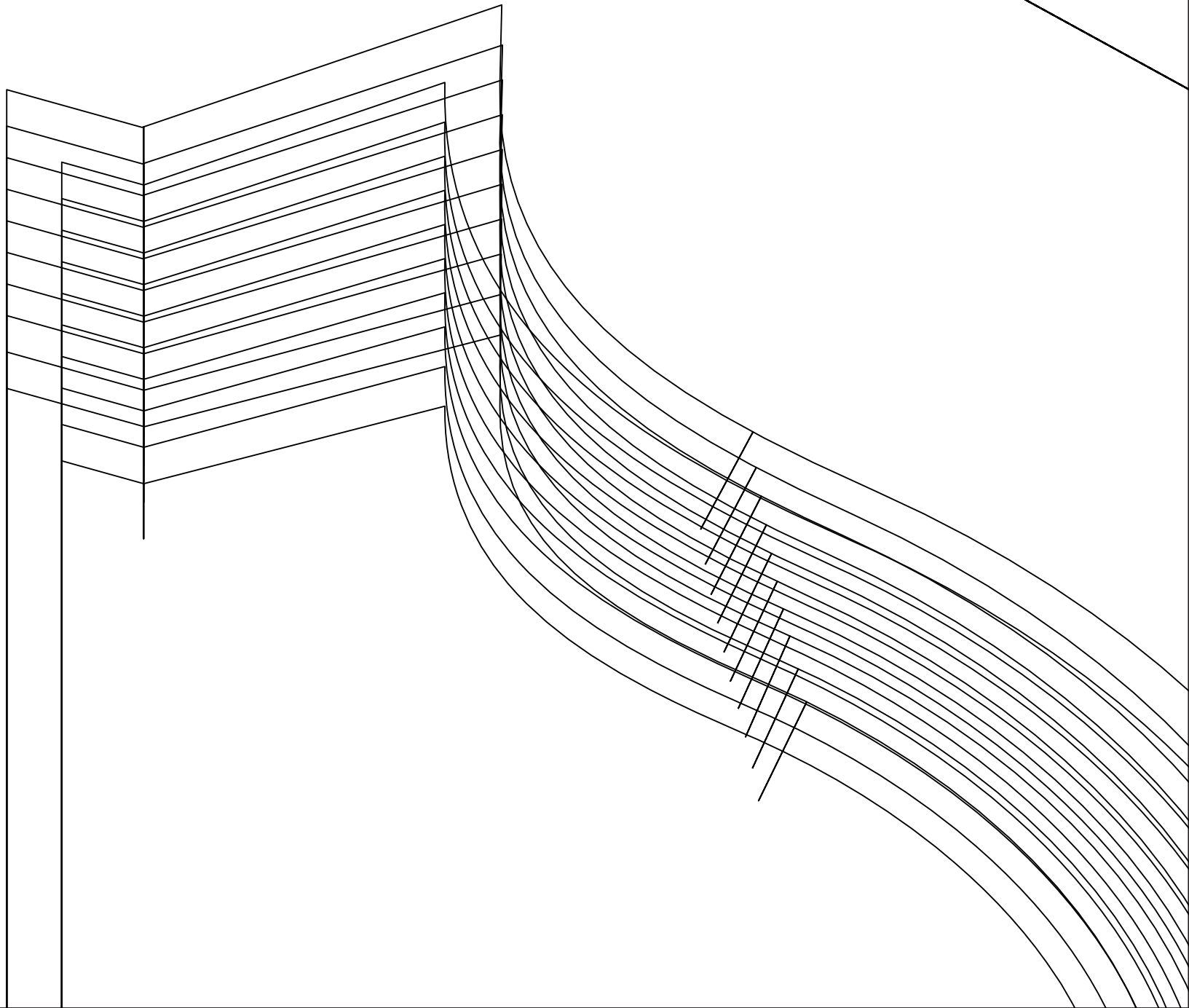



A

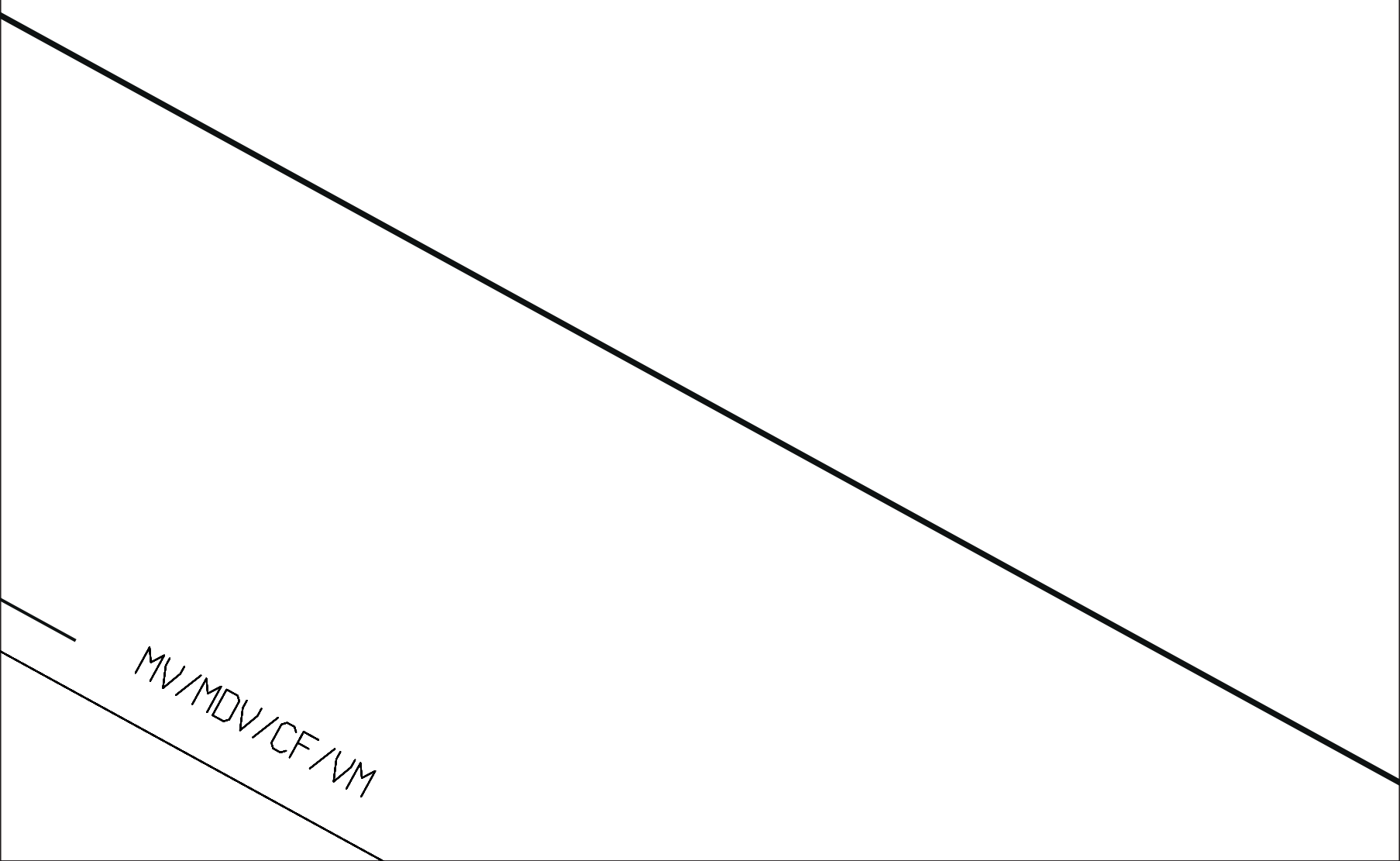

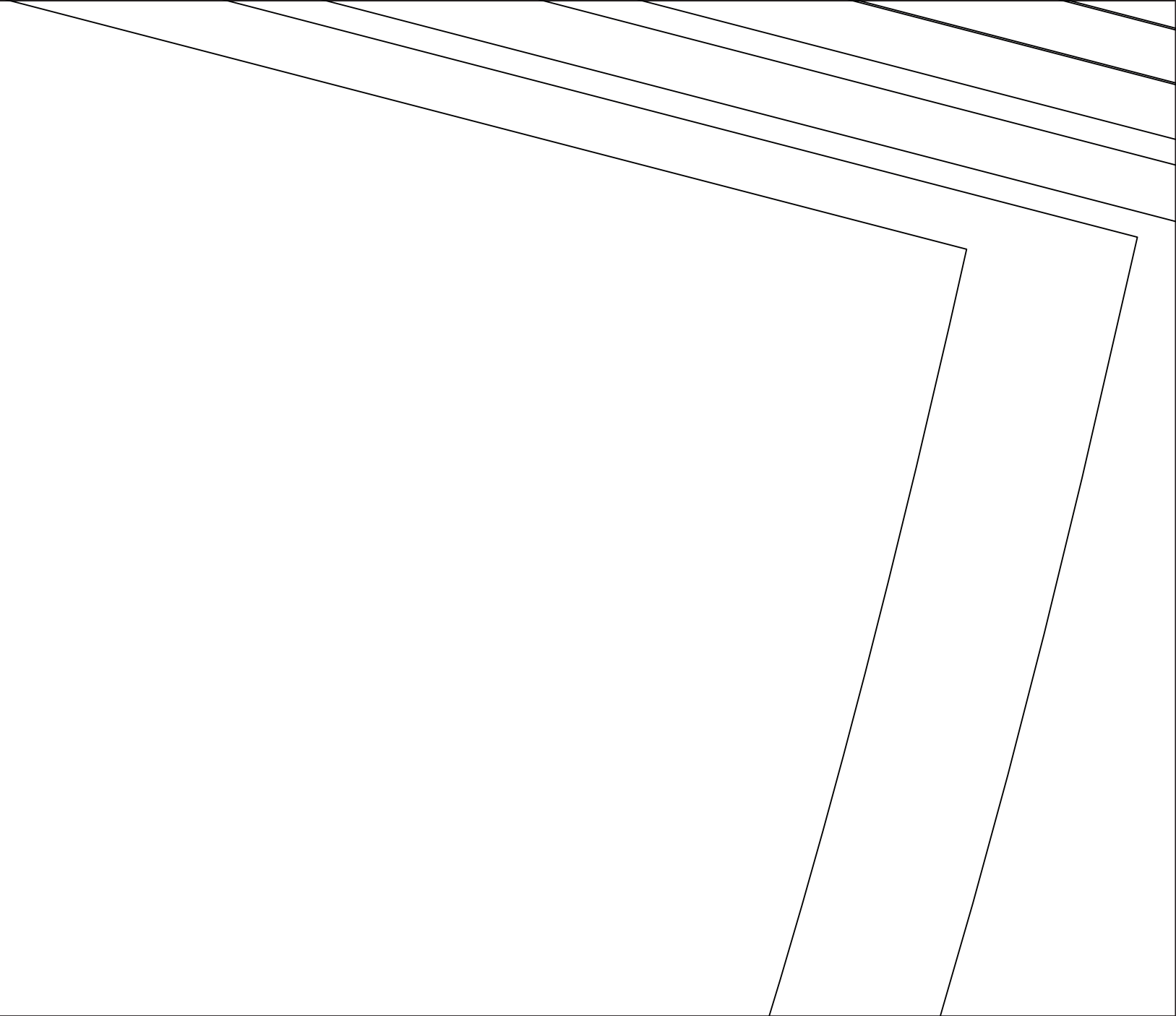

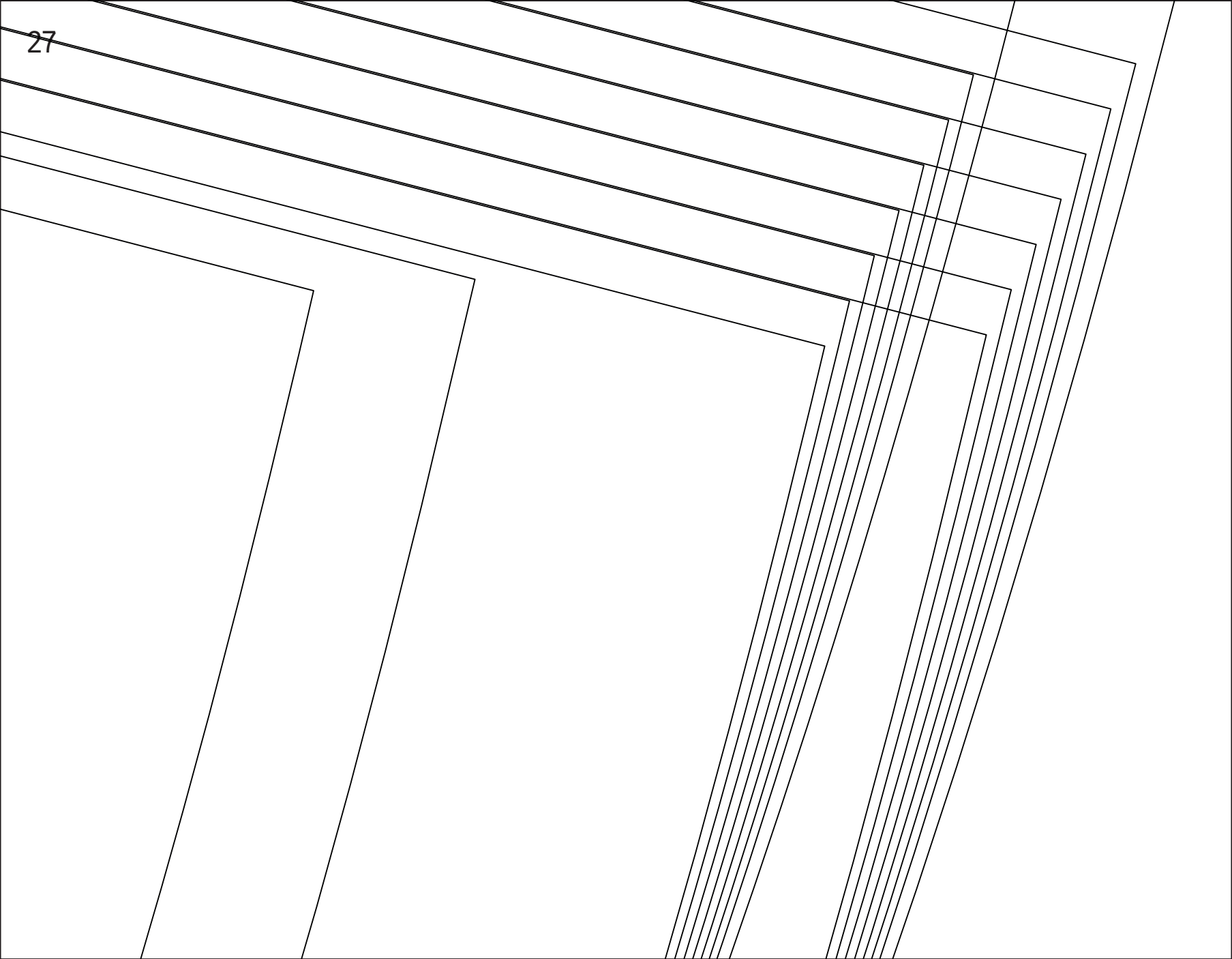

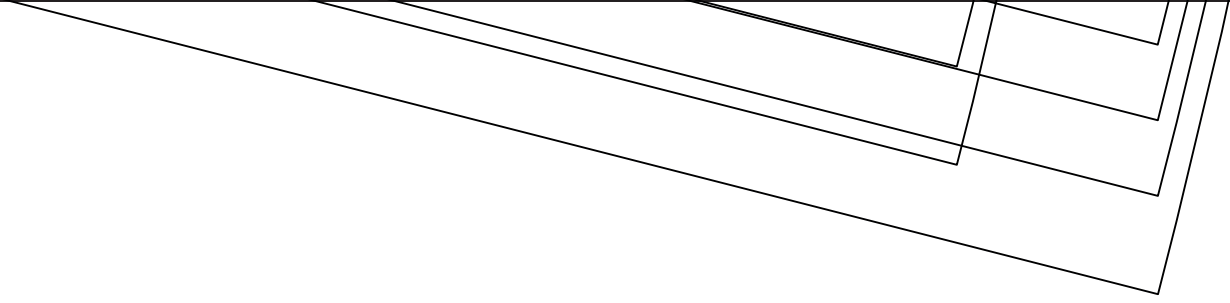



3

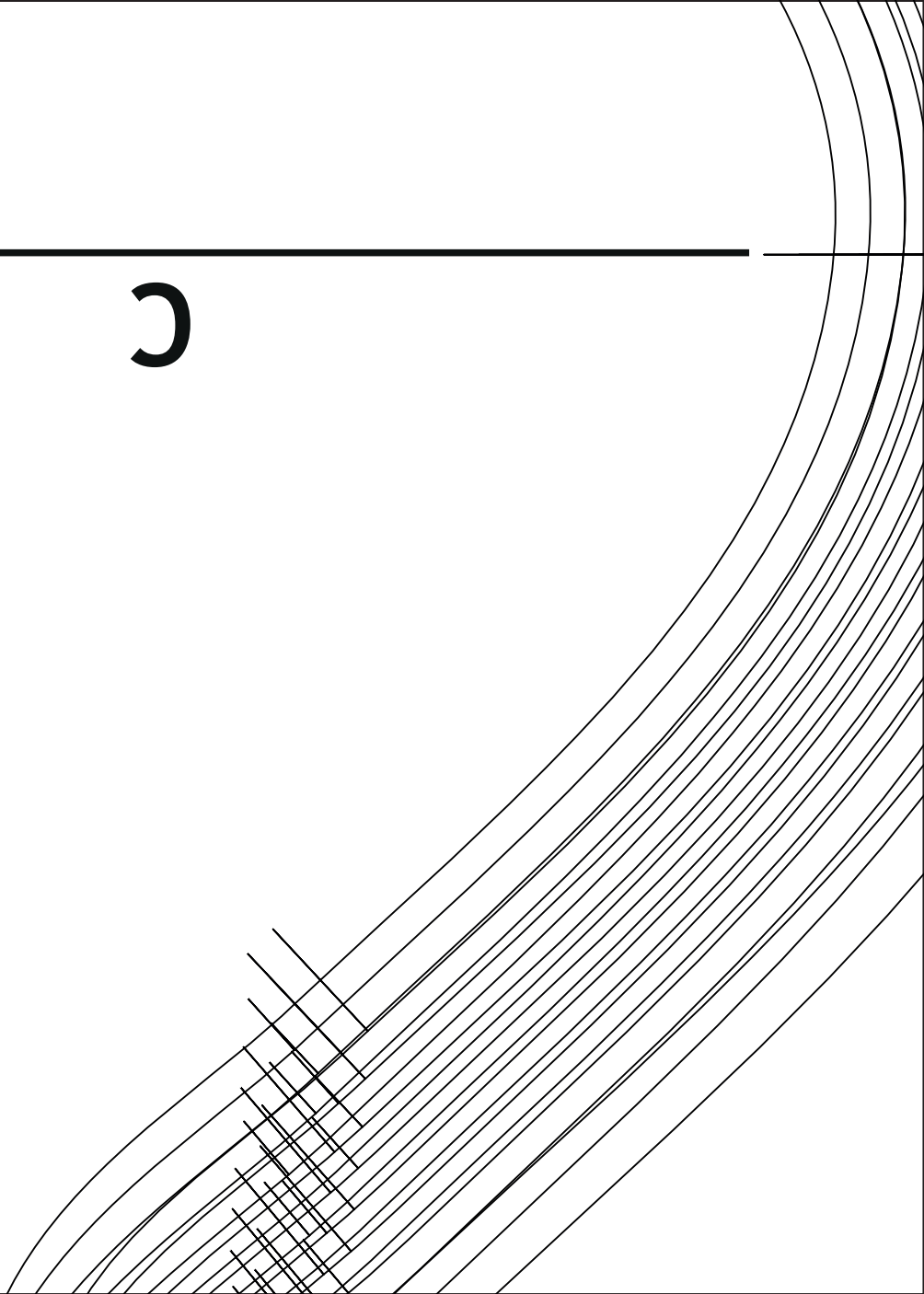

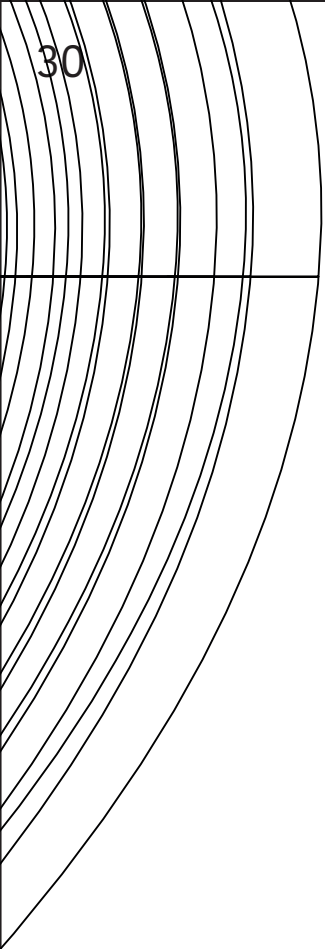

30

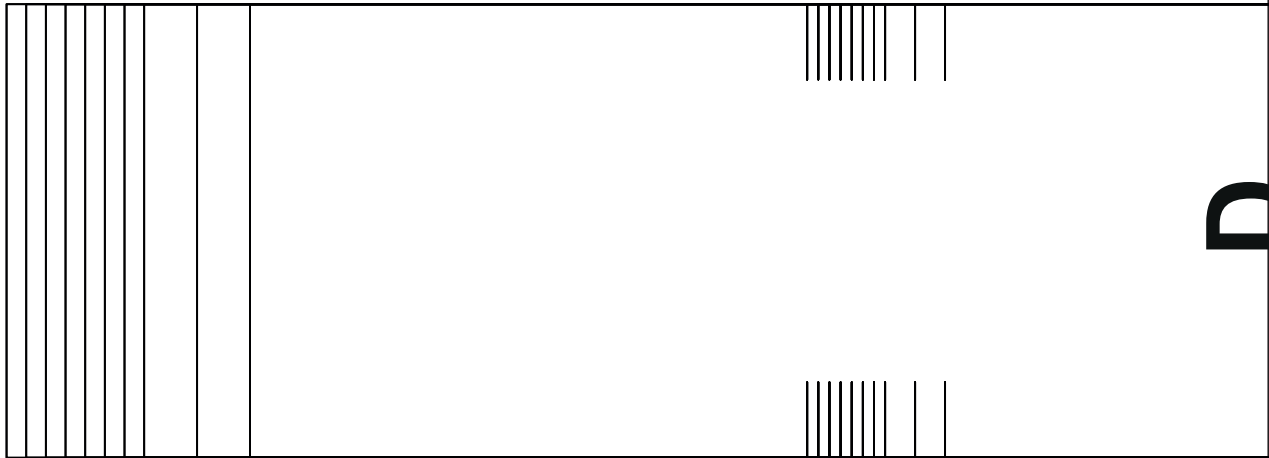

D

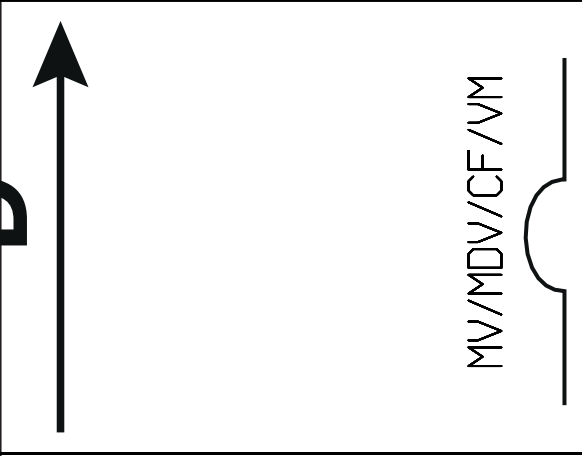

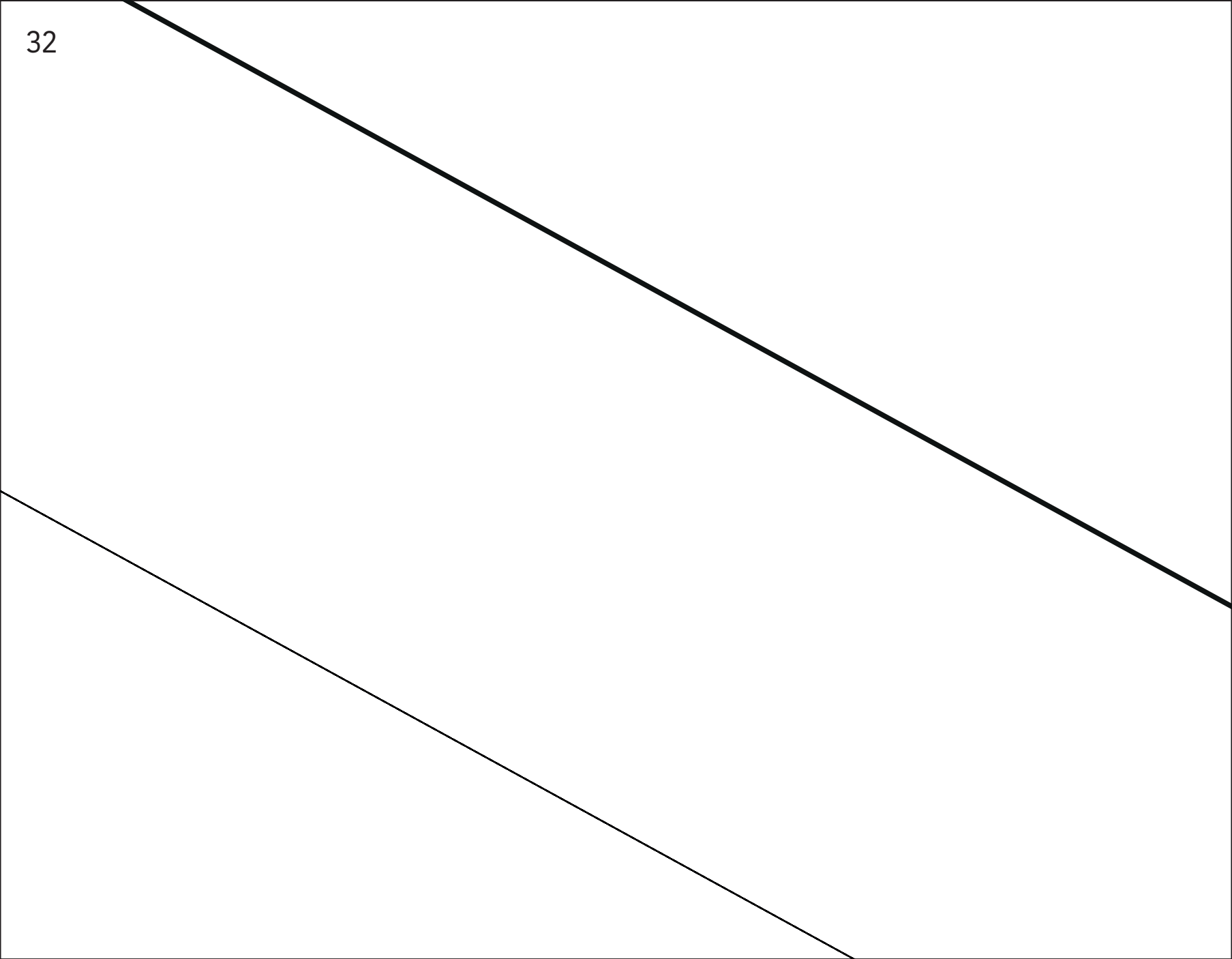

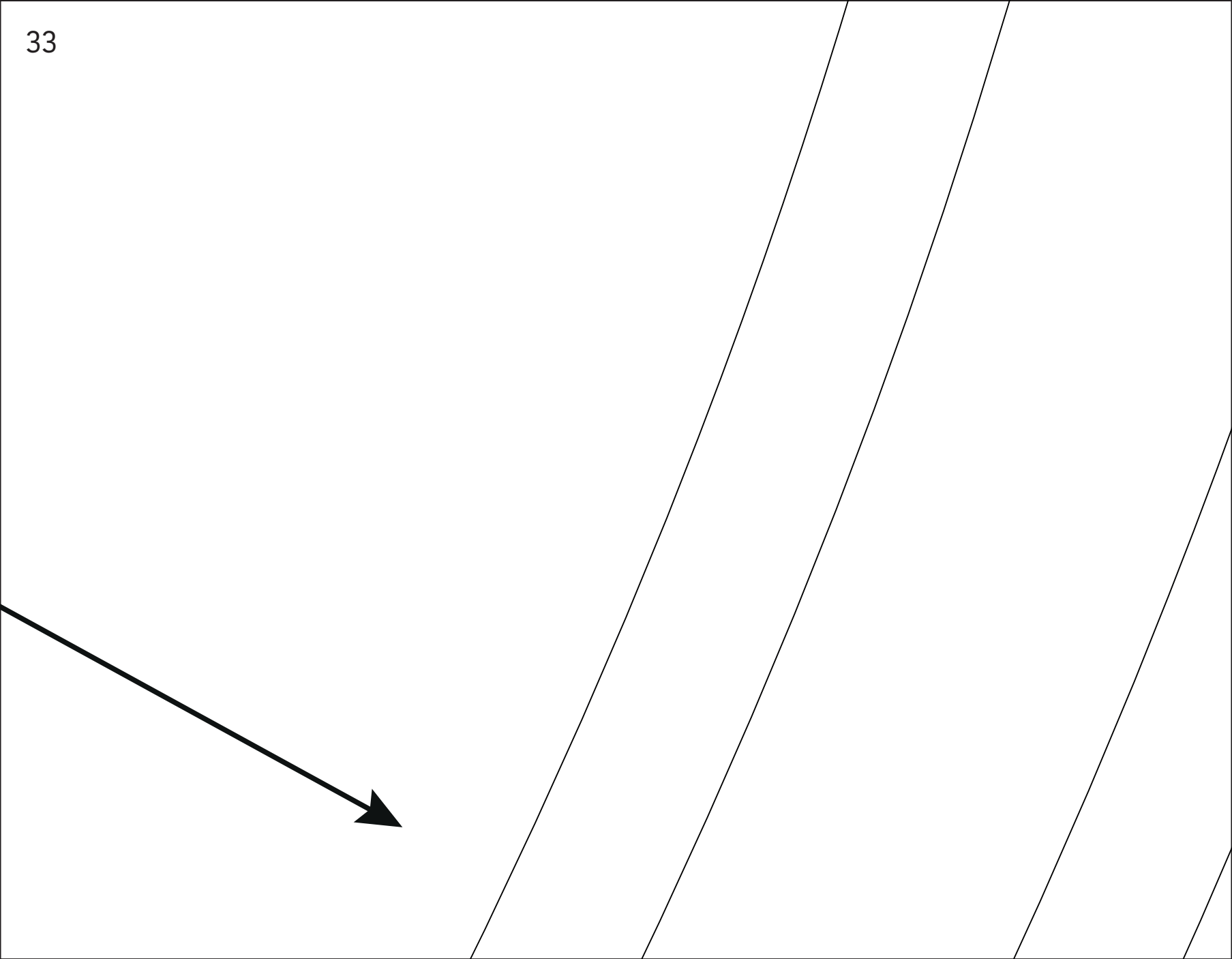



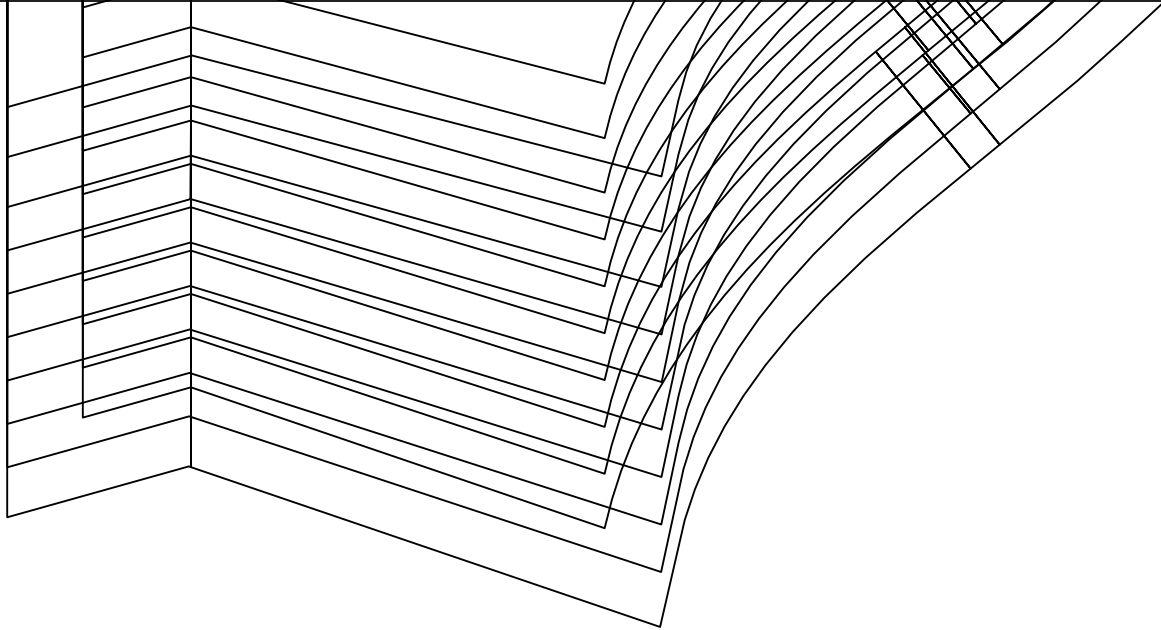

40

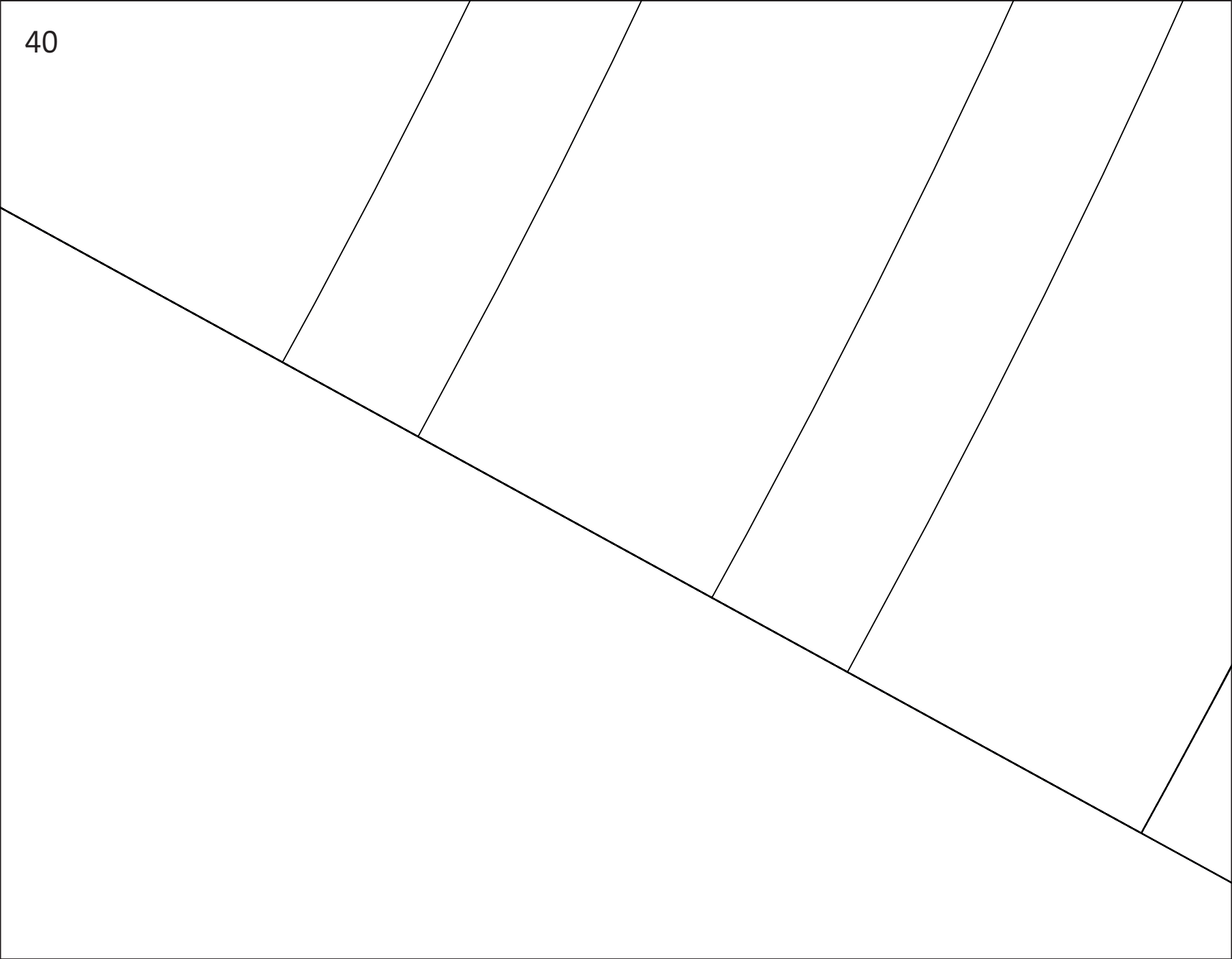

41

