

Patroonschema / Schéma du Patron / Pattern Diagram /  
Übersichtsplan zum Zusammenkleben

1	<del>2</del>	3	4	5	6	7
8	9	10	11	12	13	14
15	16	17	18	19	20	21
22	23	24	25	26	27	28
29	30	31	32	33	34	35
<del>36</del>	<del>37</del>	38	39	40	41	

Controlevierkant / Carré de controle  
/ Test square / Kontrollquadrat

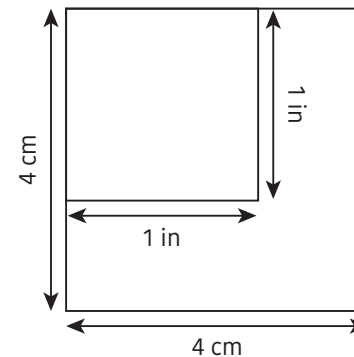

## Baya

Jurk / Robe /  
Dress / Kleid

Patroondelen / Pièces du patron  
/ Pattern pieces / Schnittteile:

- A** voorpand / devant / front panel /  
Vorderteil
- B** rugpand / dos / back panel /  
Rückenteil
- C** mouw / manche / sleeve / Ärmel
- D** beleg VP / parementure DV /  
facing FP / Besatz VT
- E** beleg RP / parementure du dos /  
facing BP / Besatz RT
- F** lint / ruban / ribbon / band



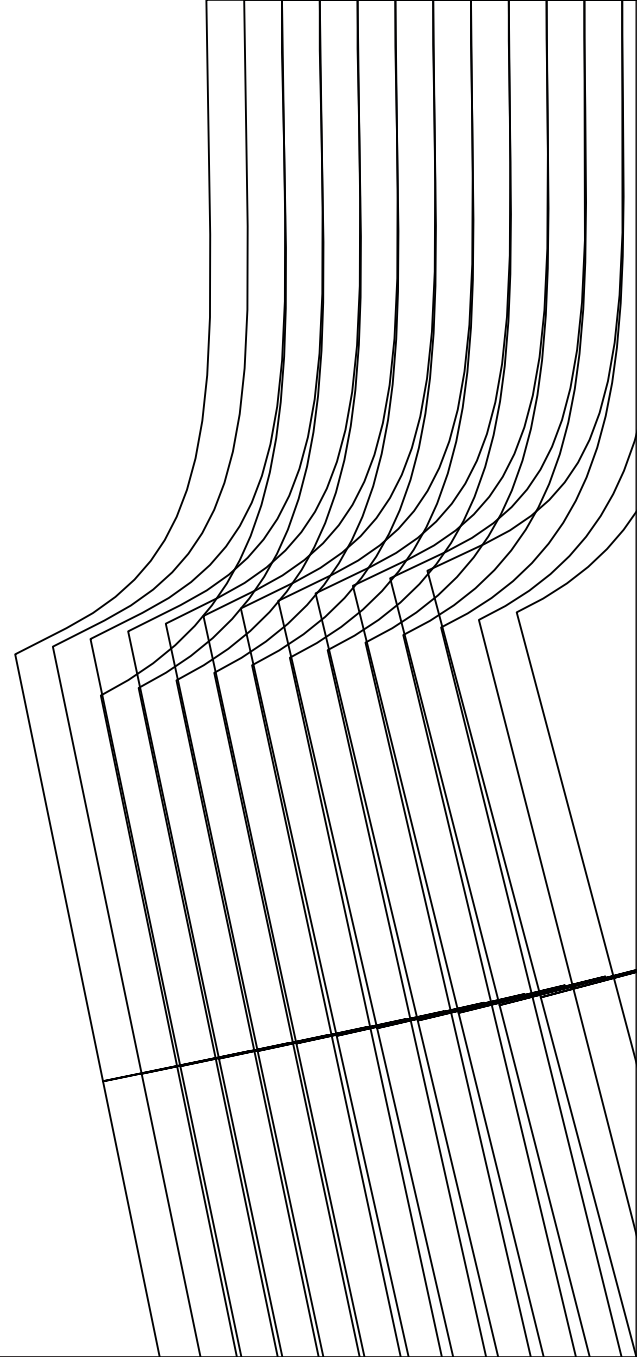
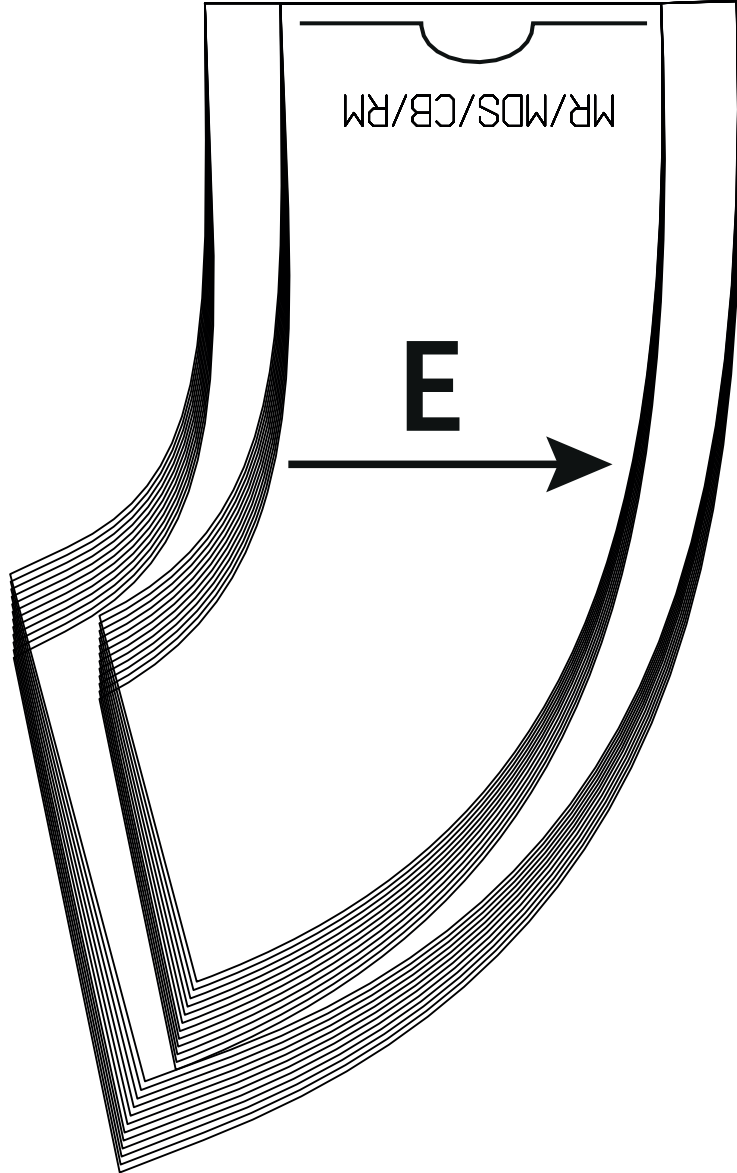



**B**



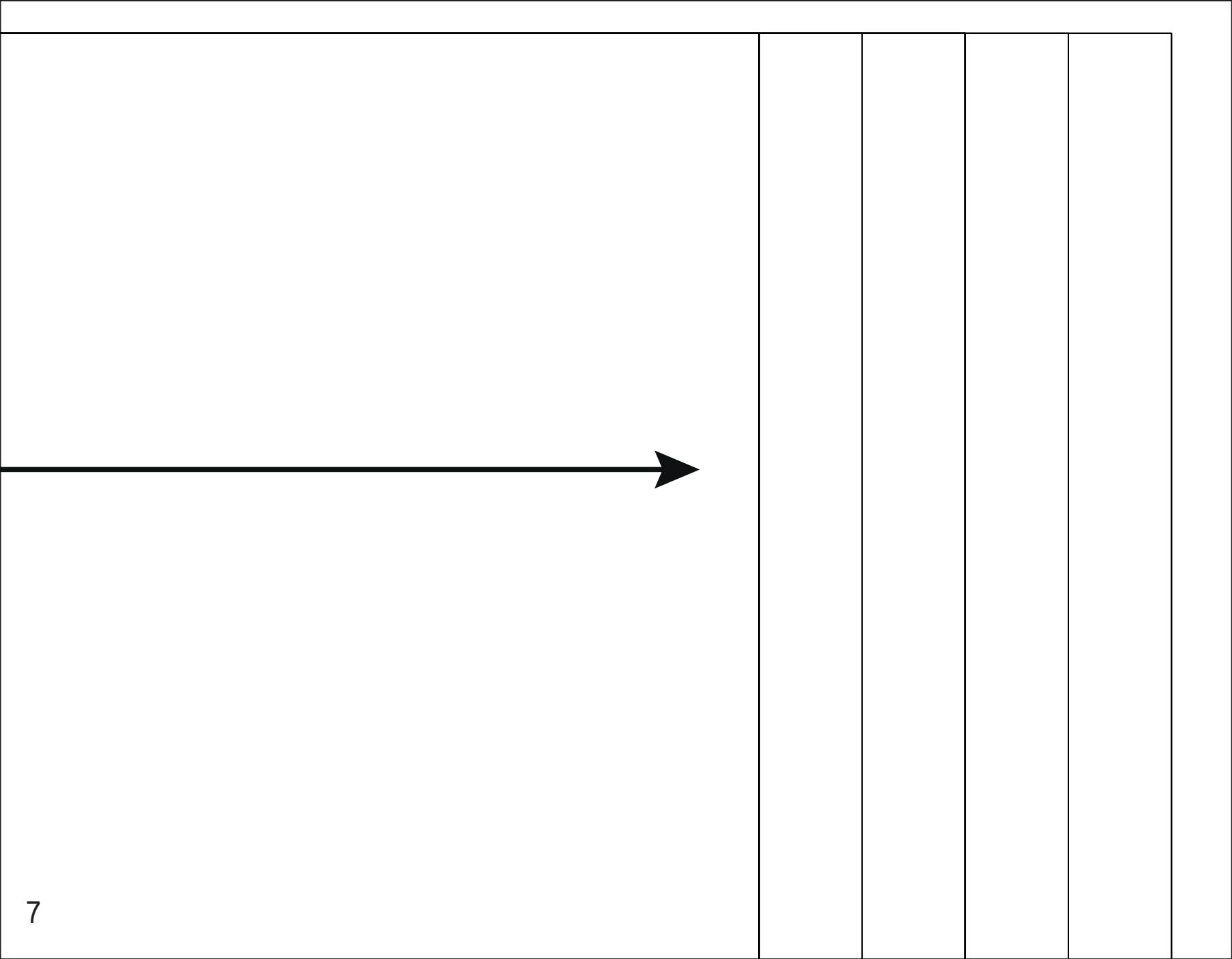

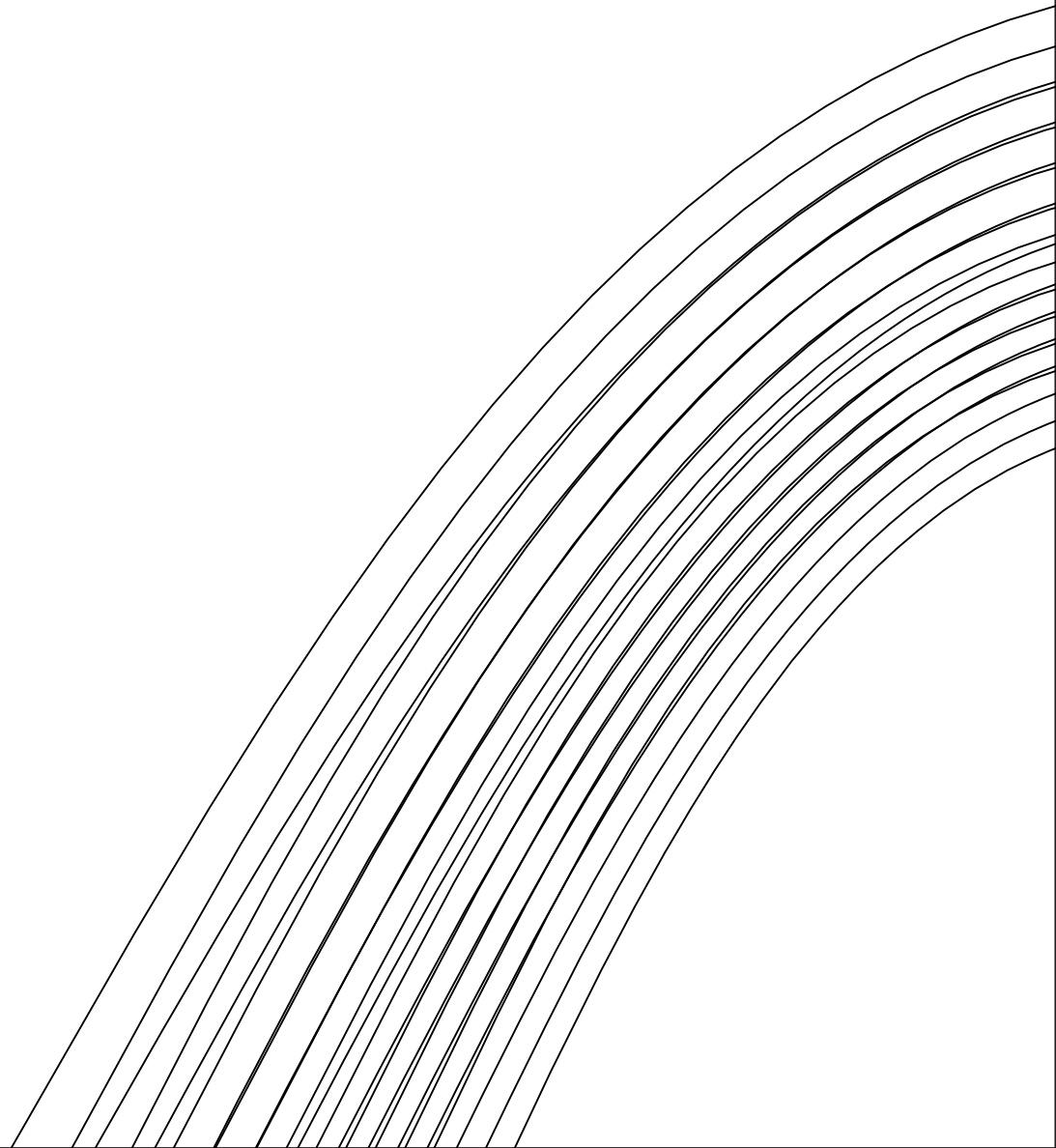



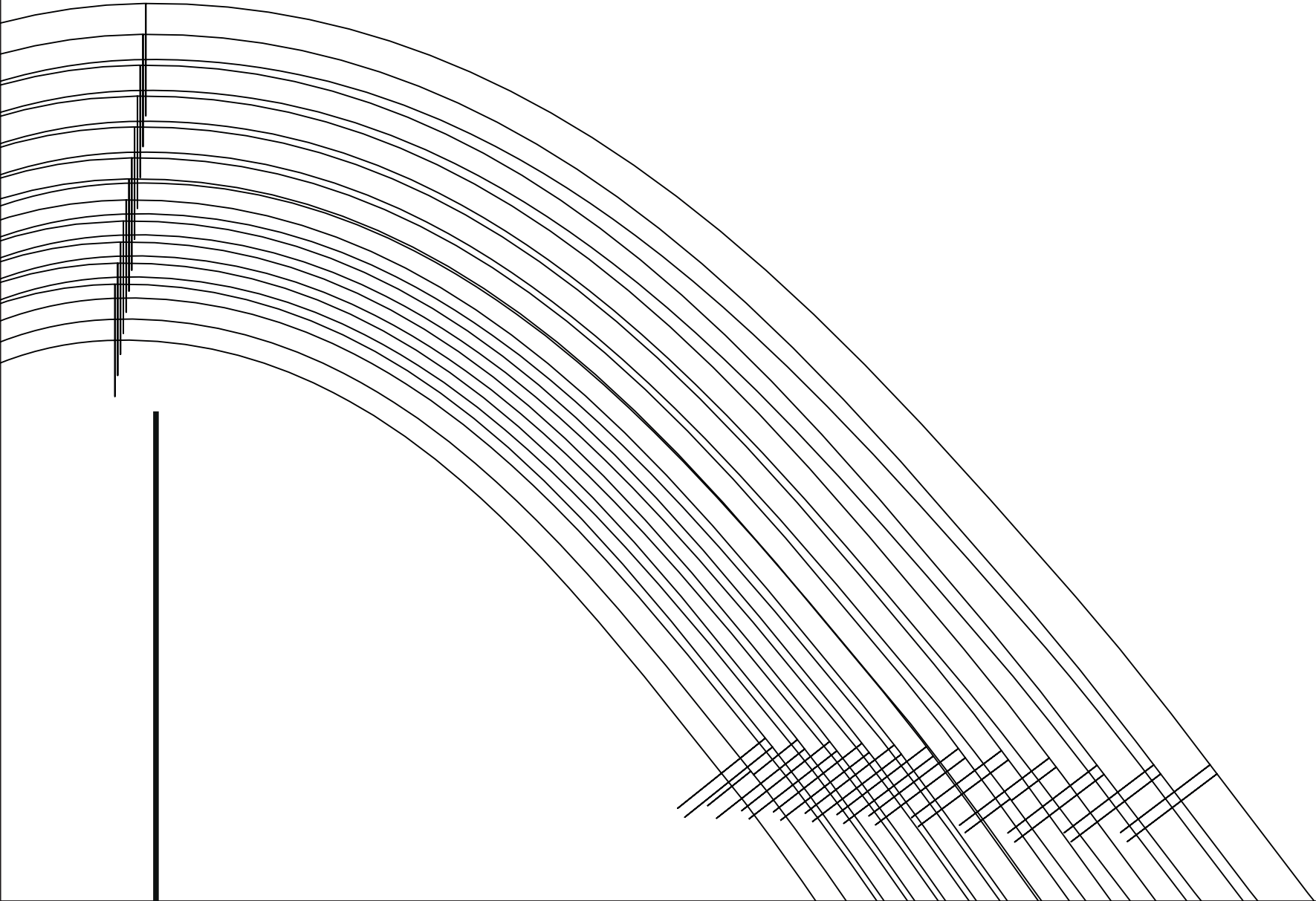

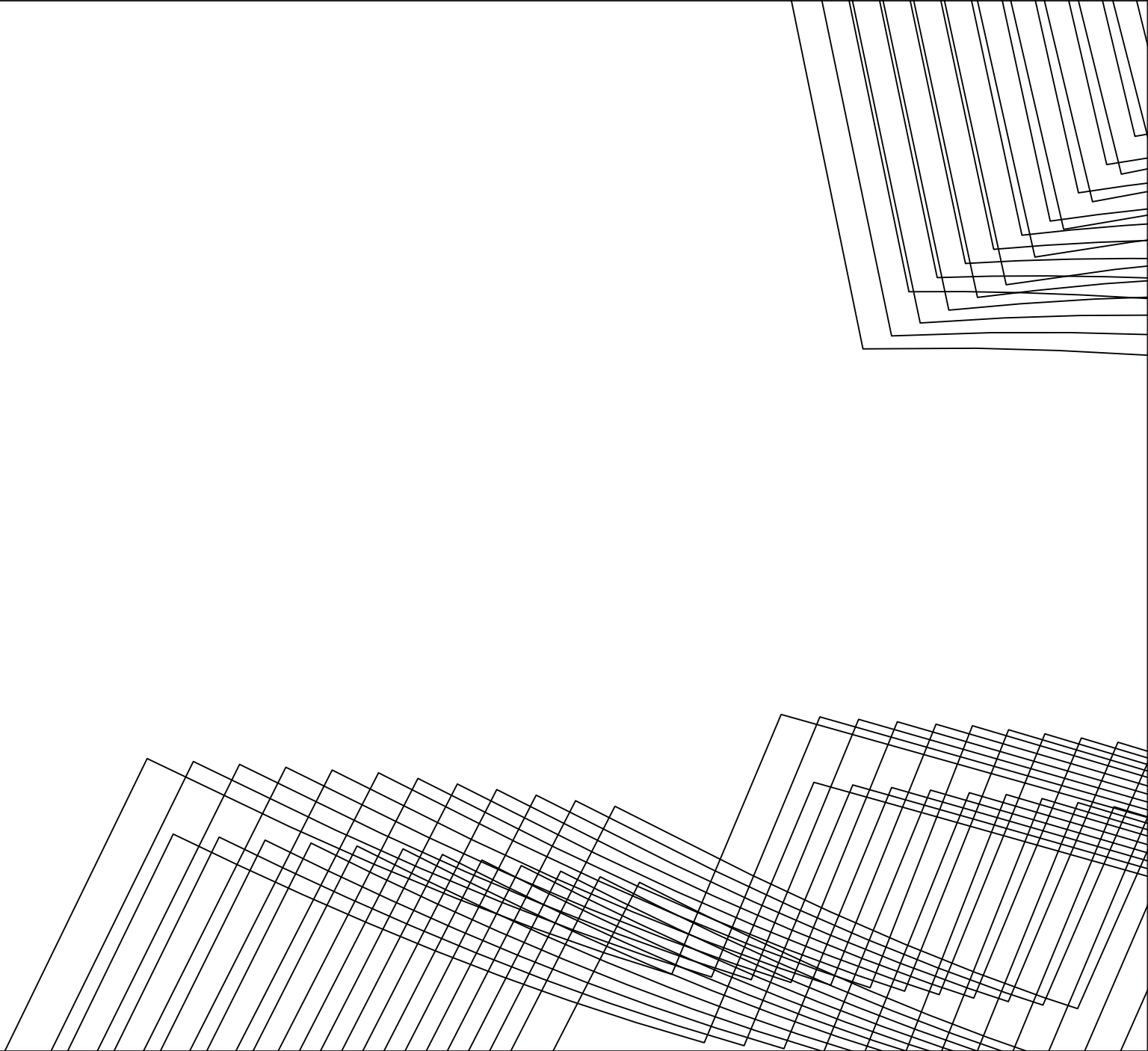

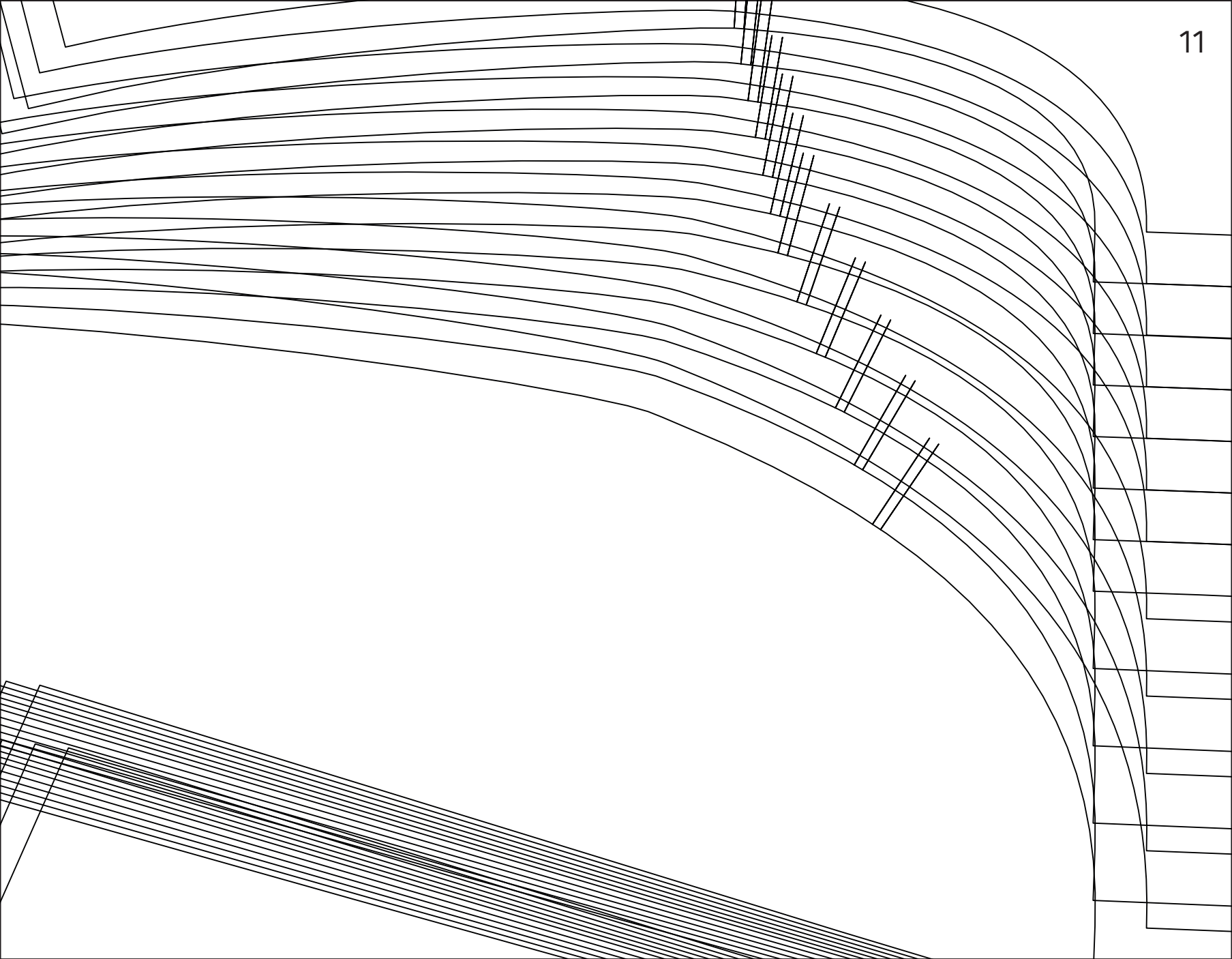





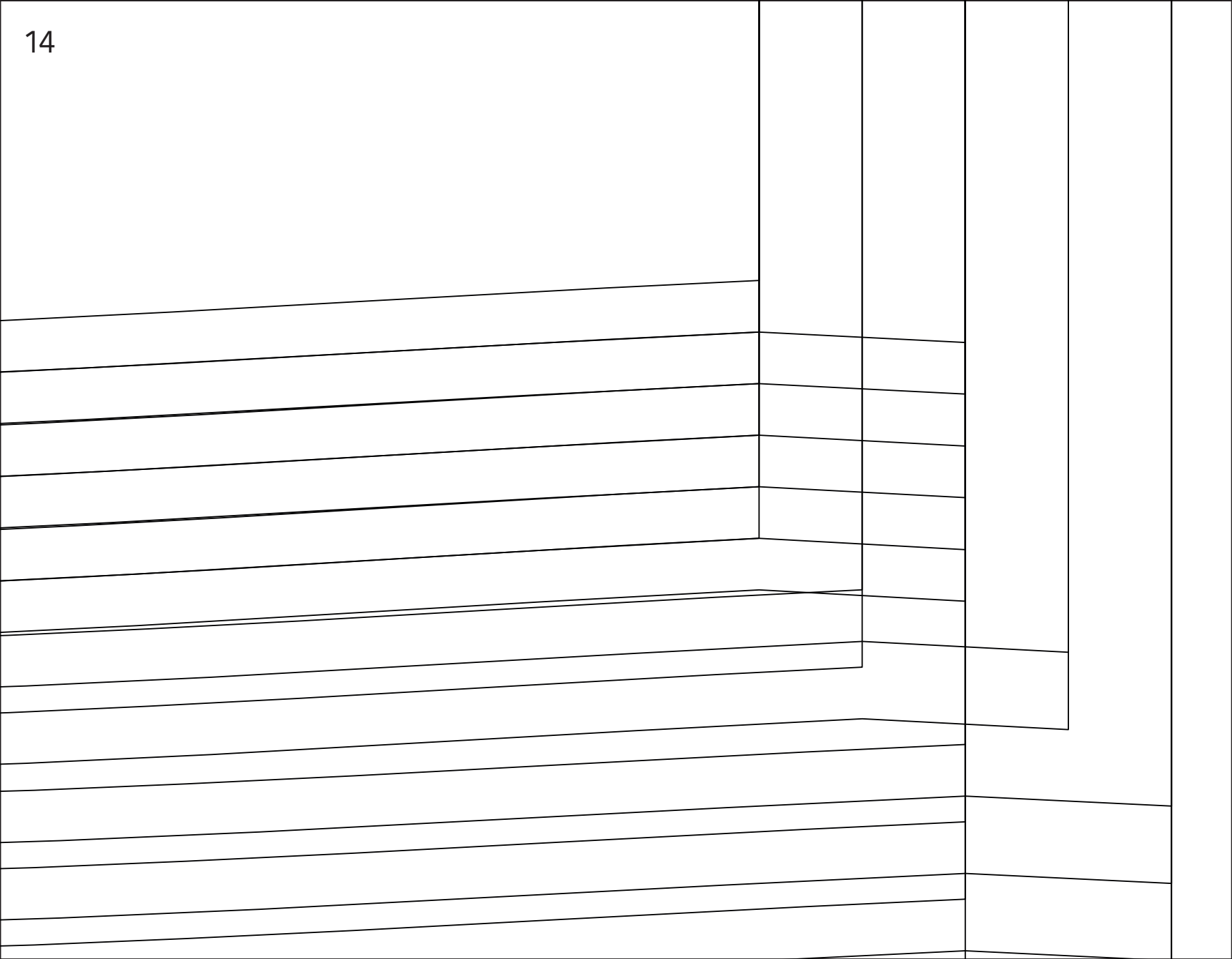

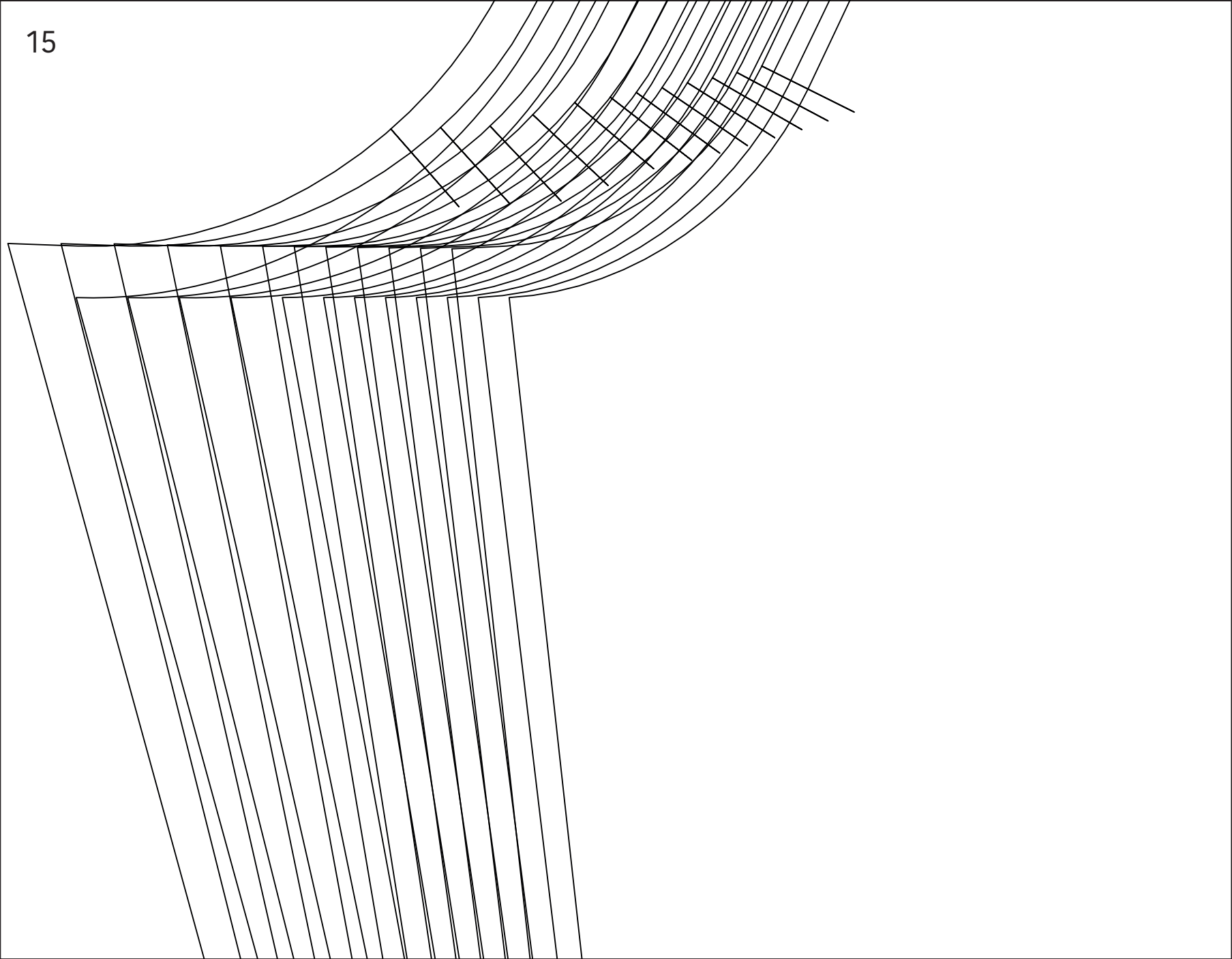

C

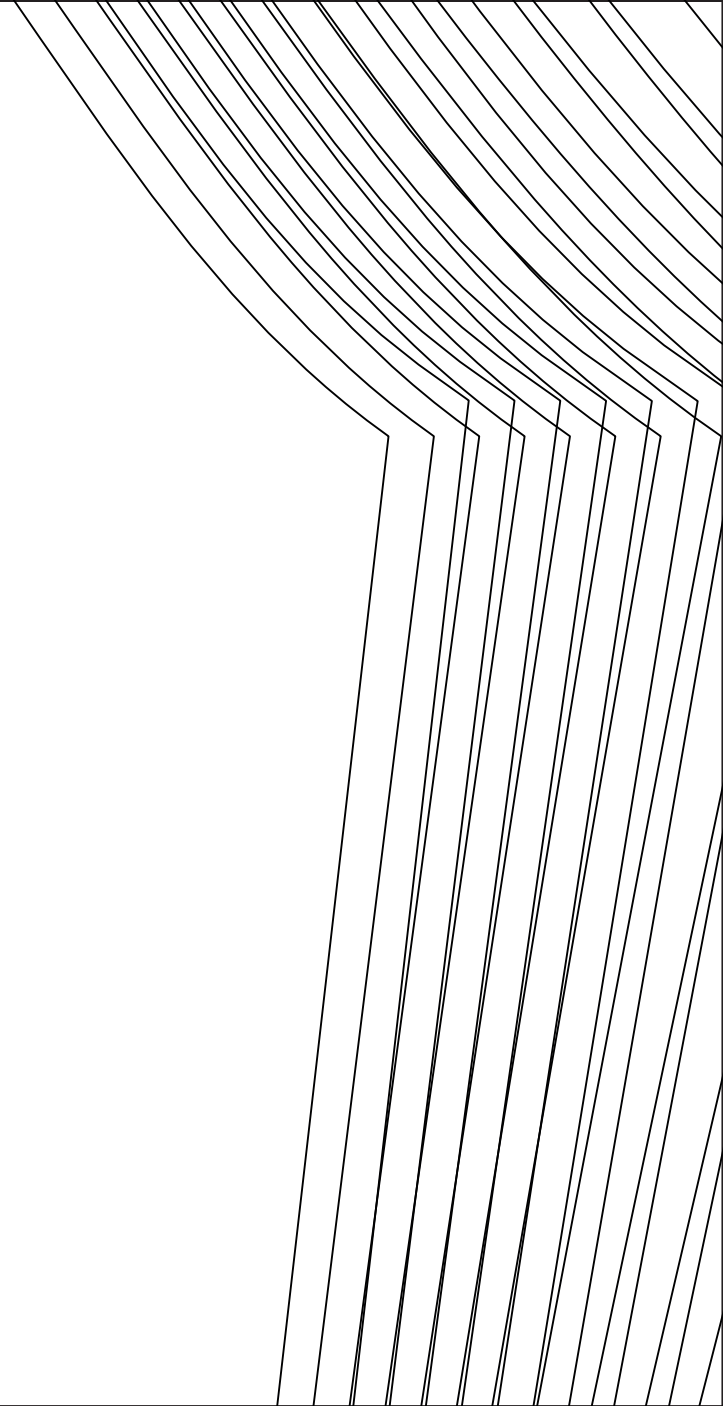



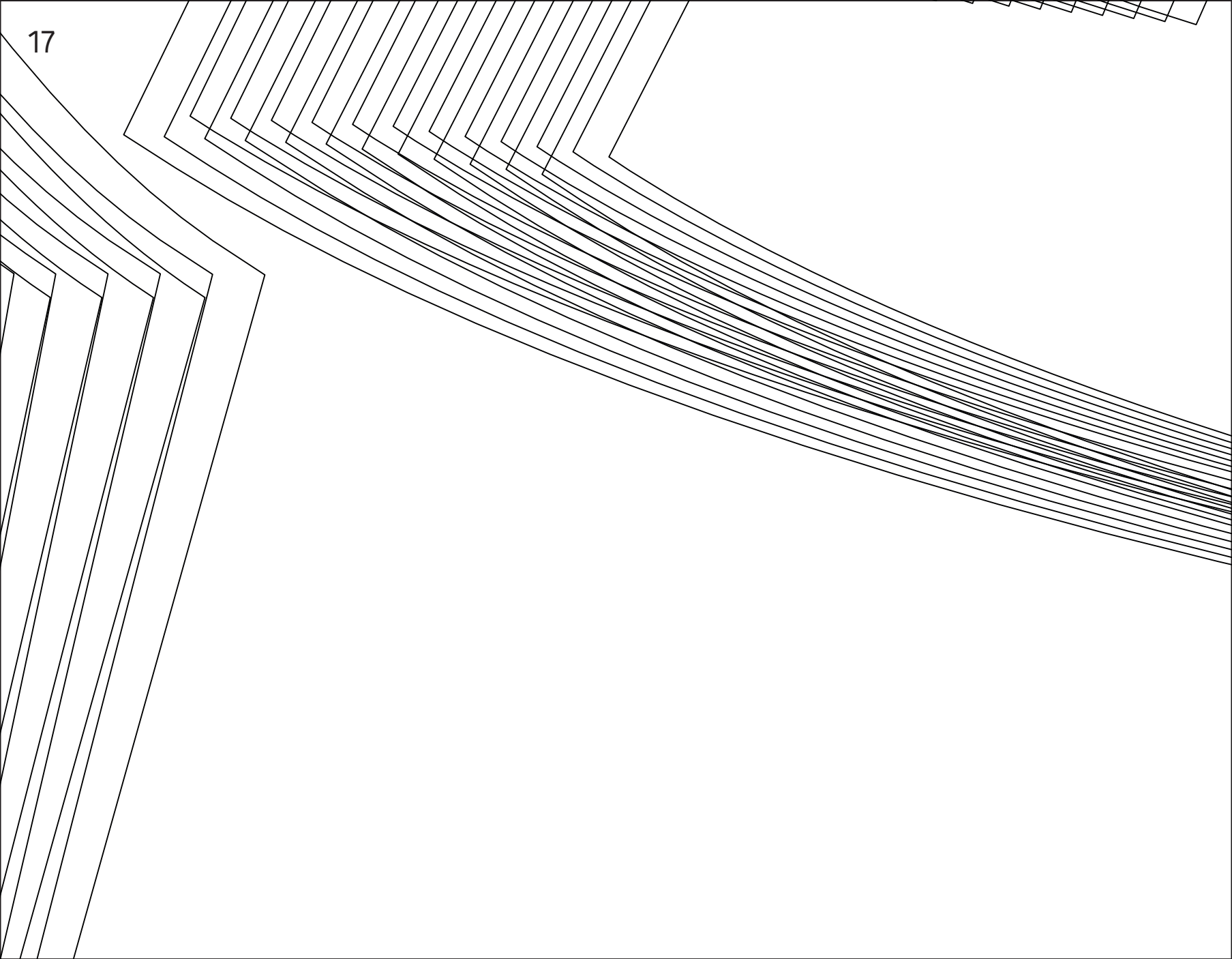

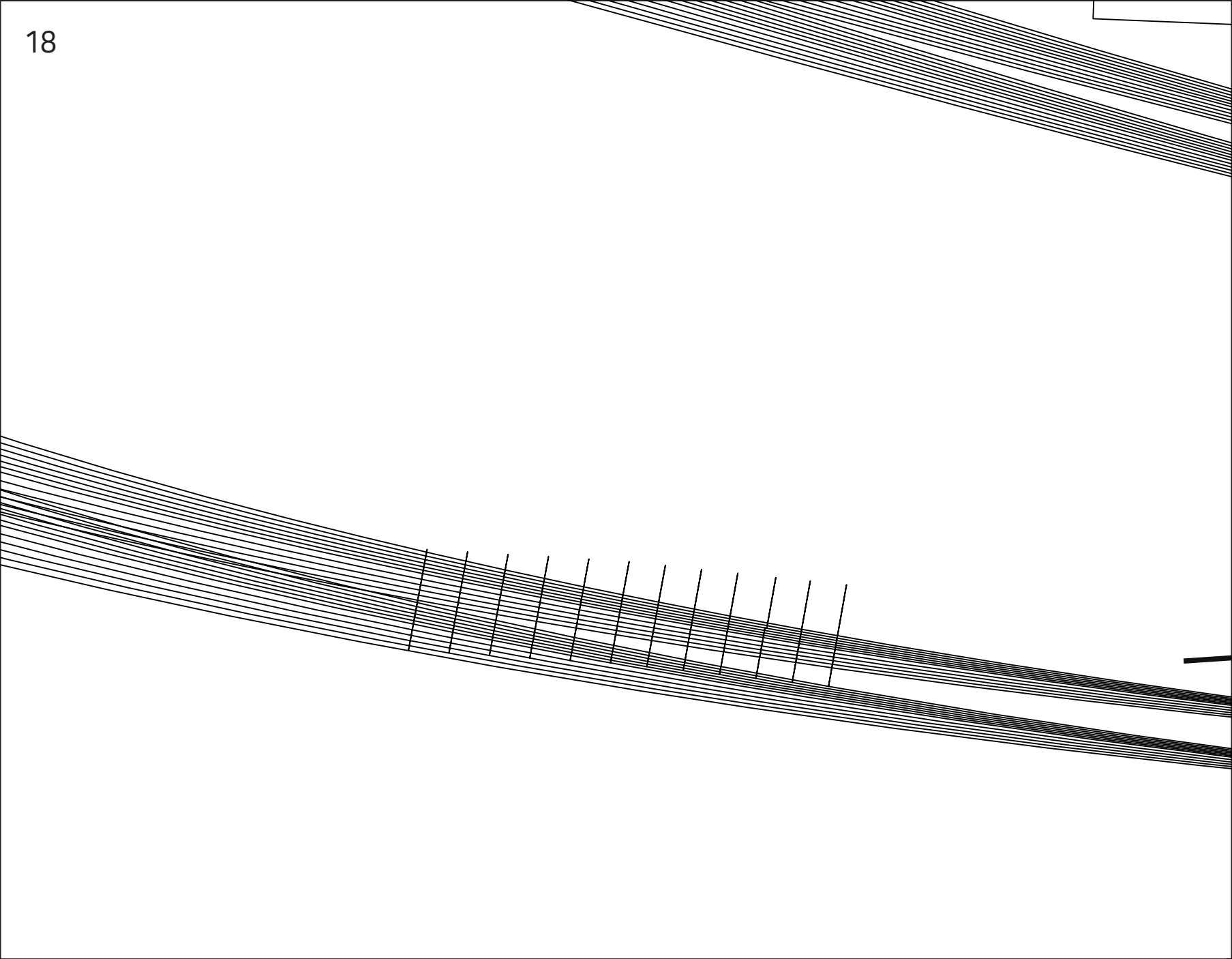

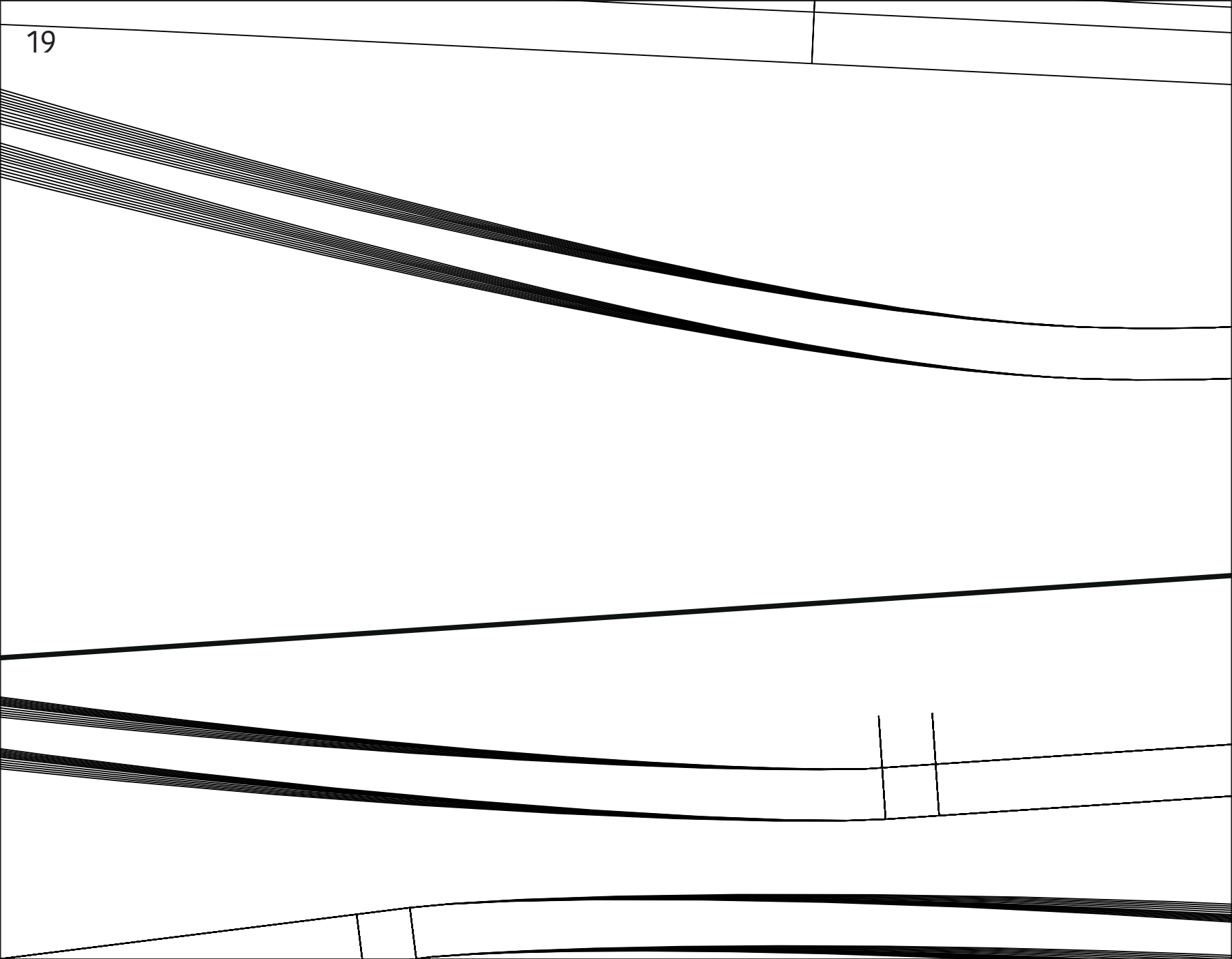

**D**

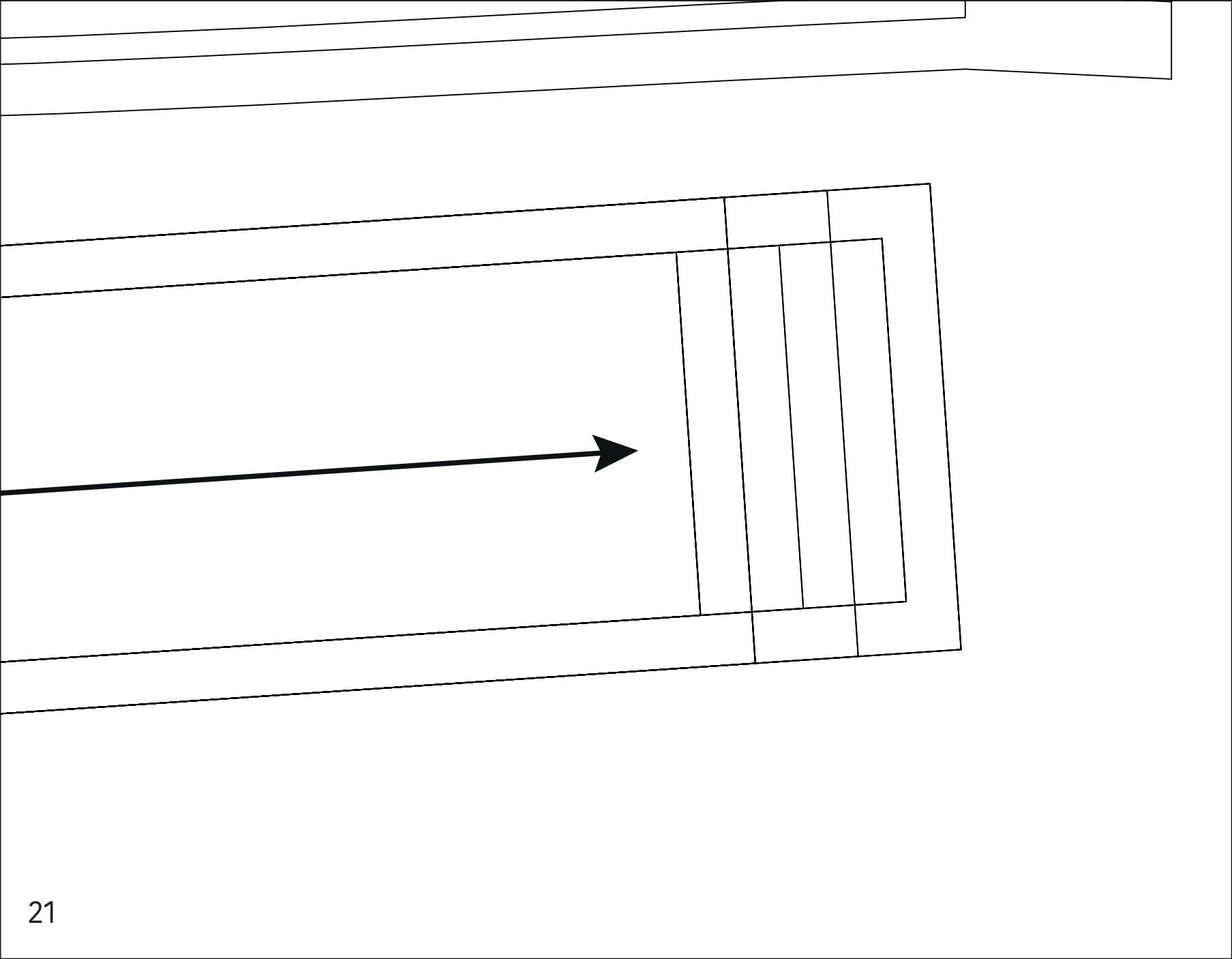

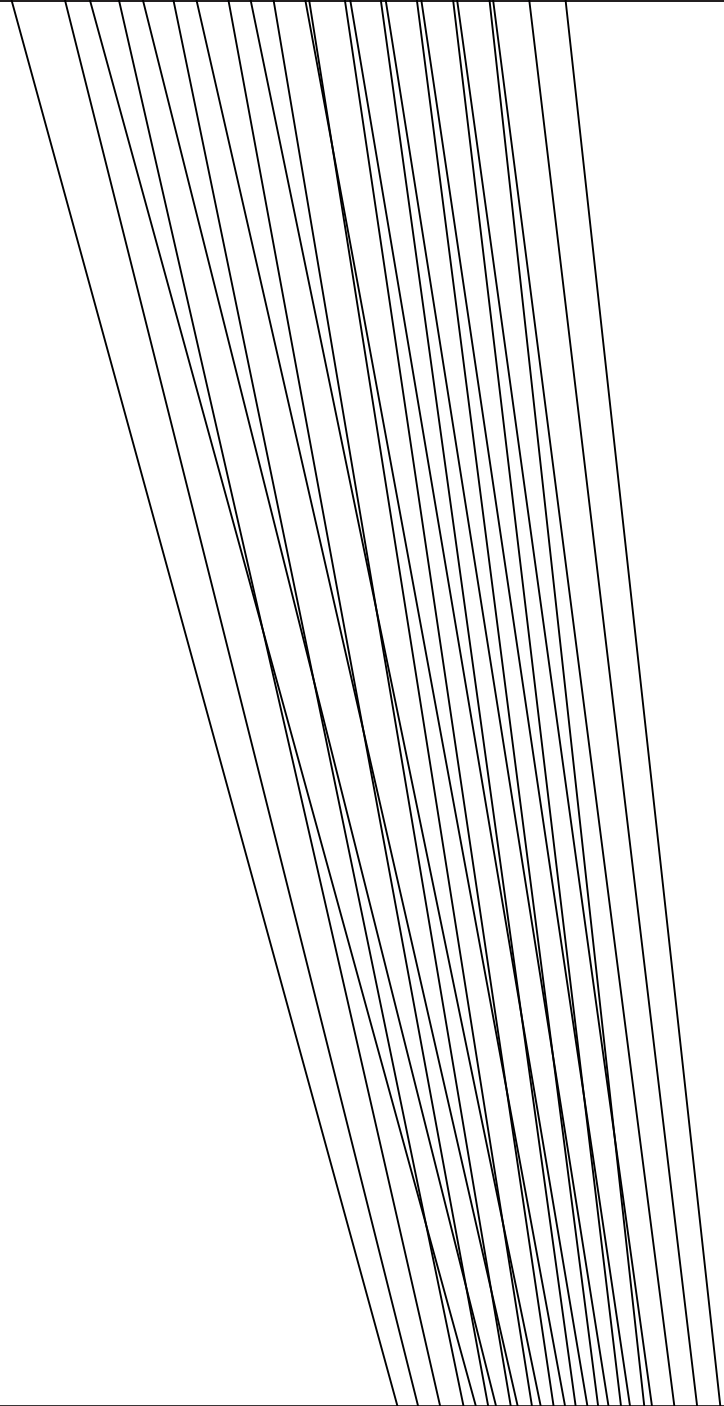

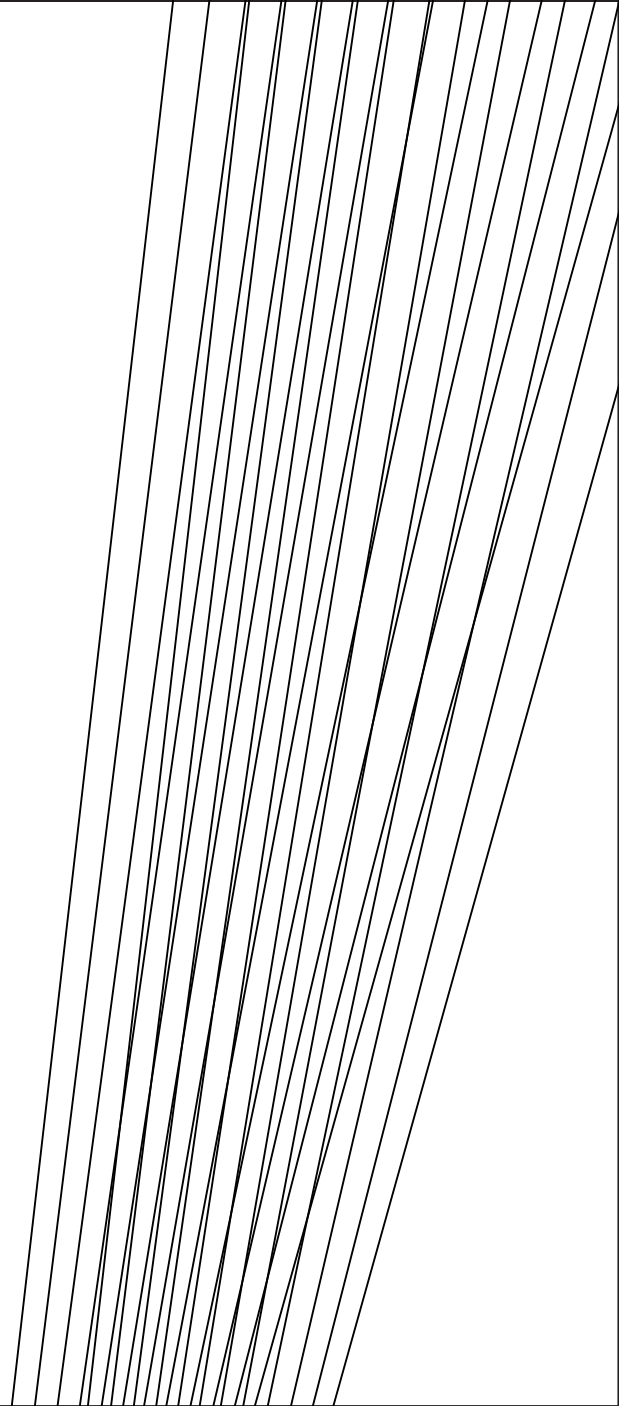

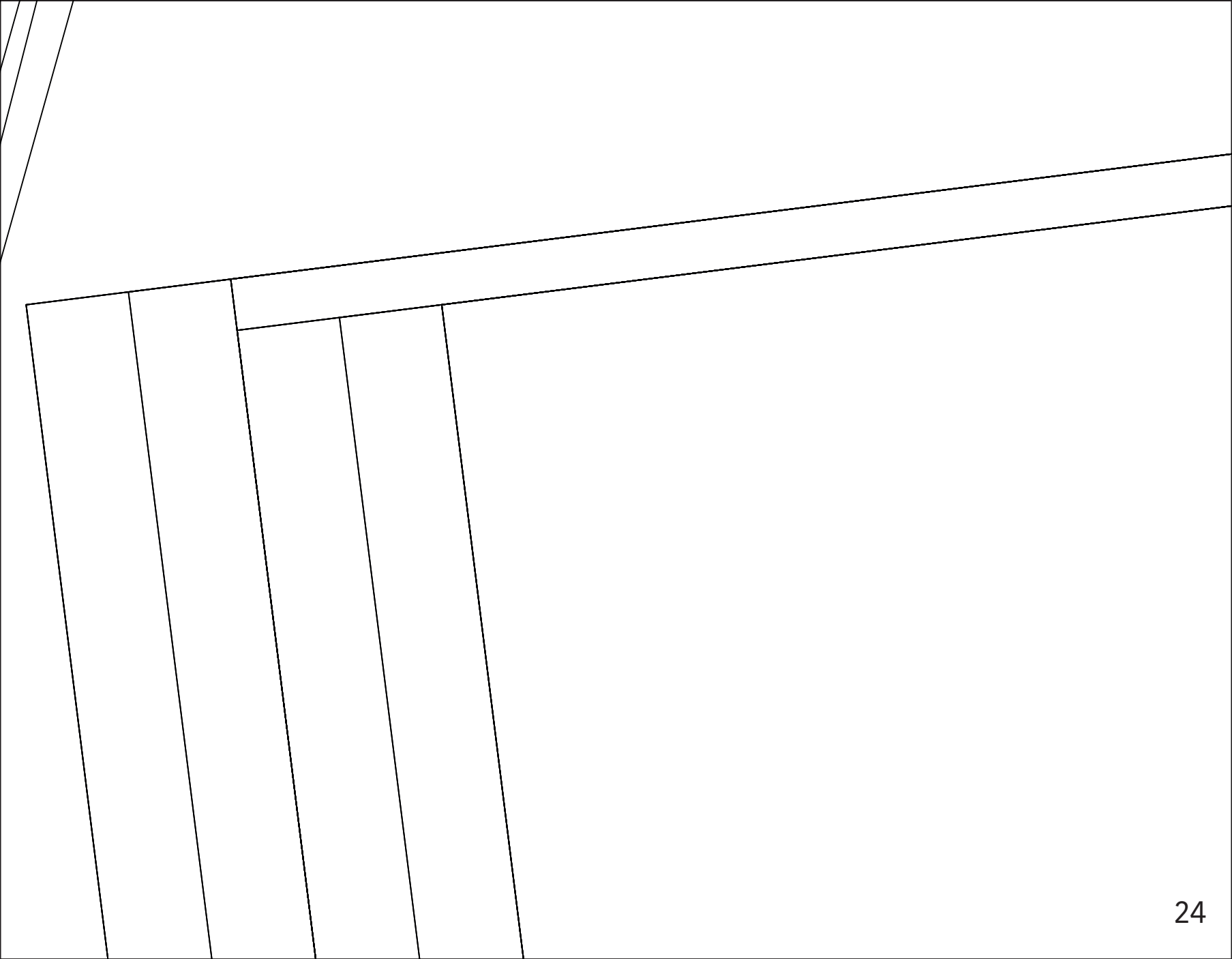



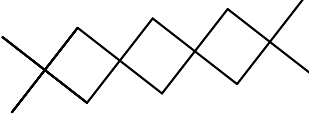
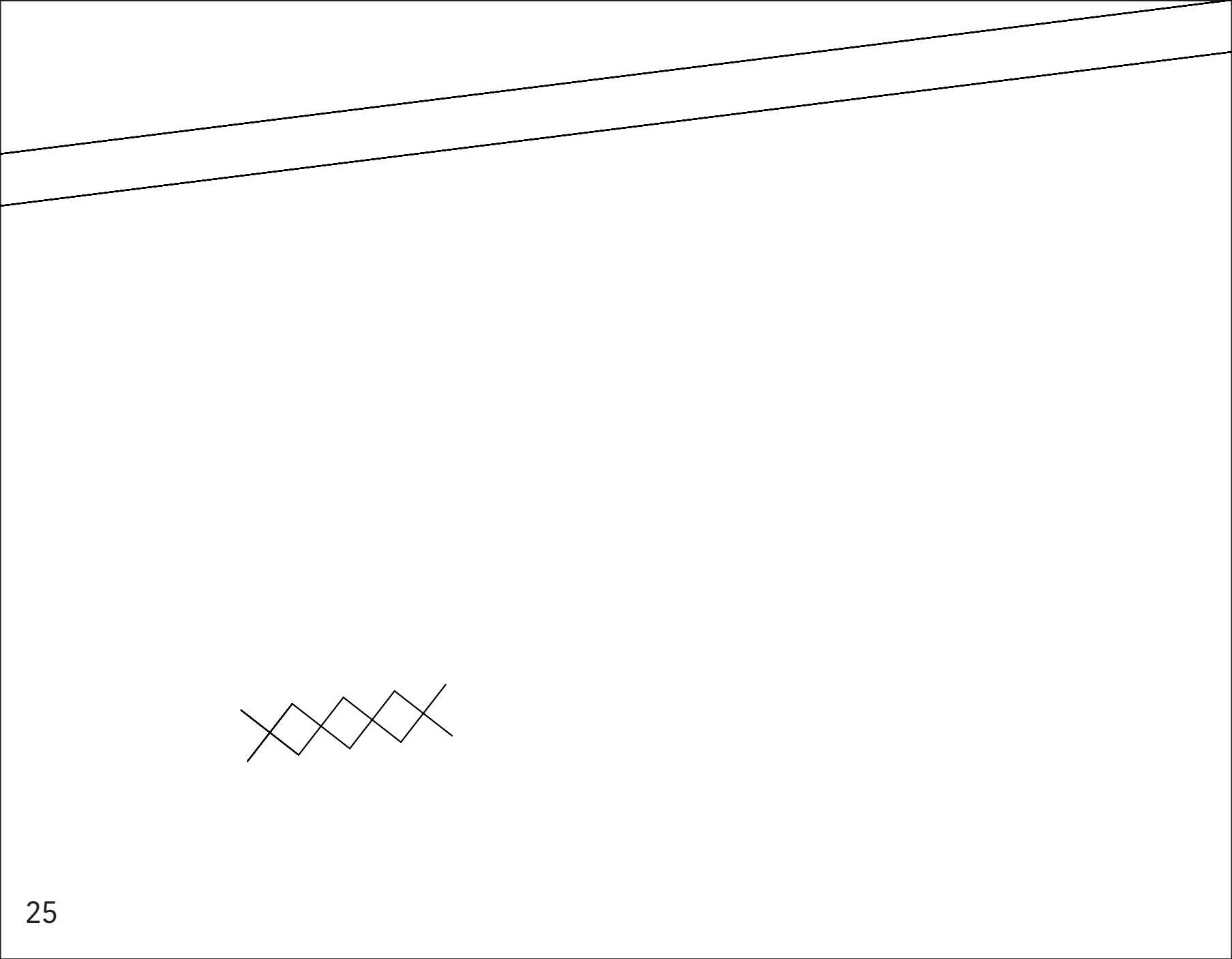



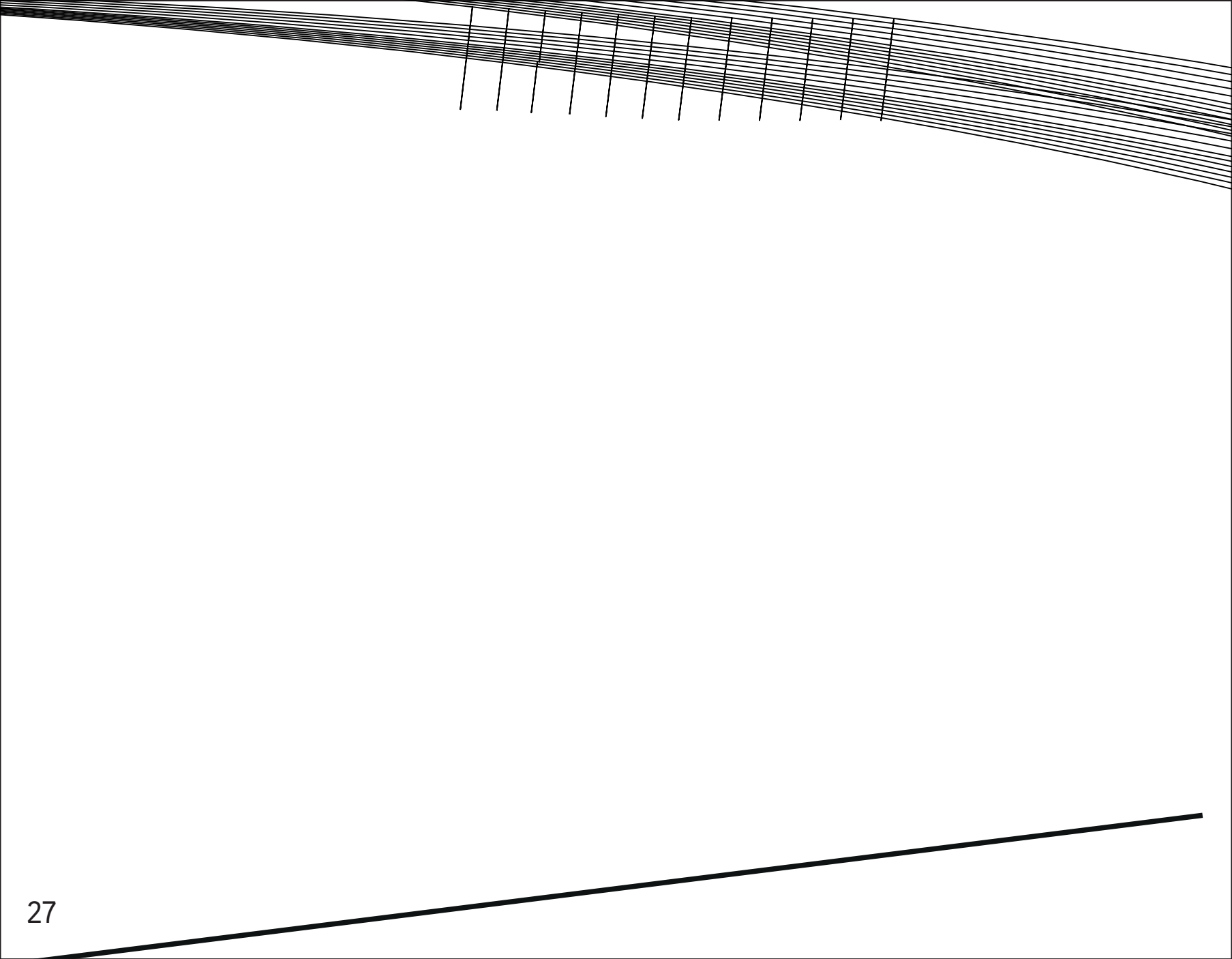

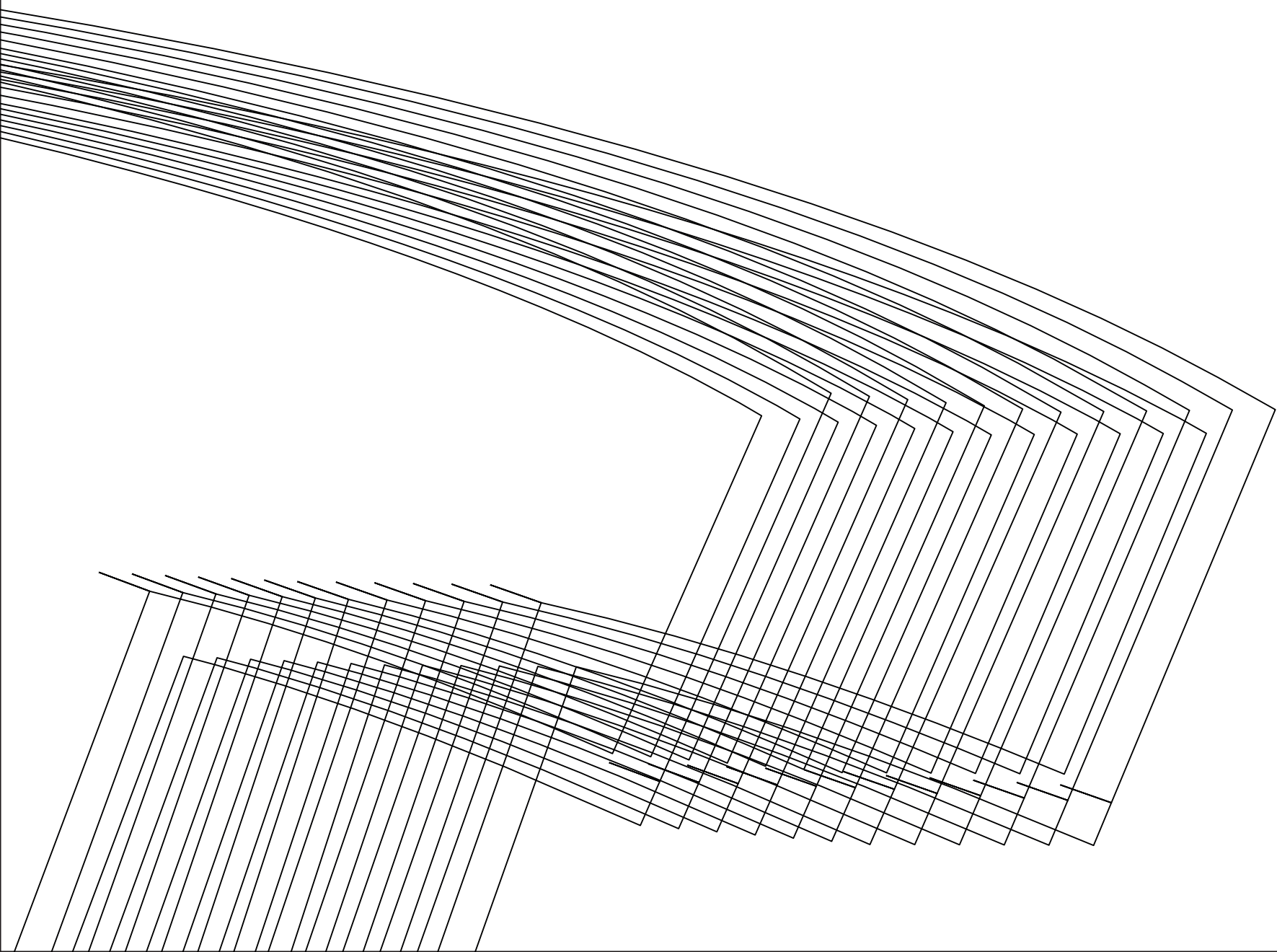

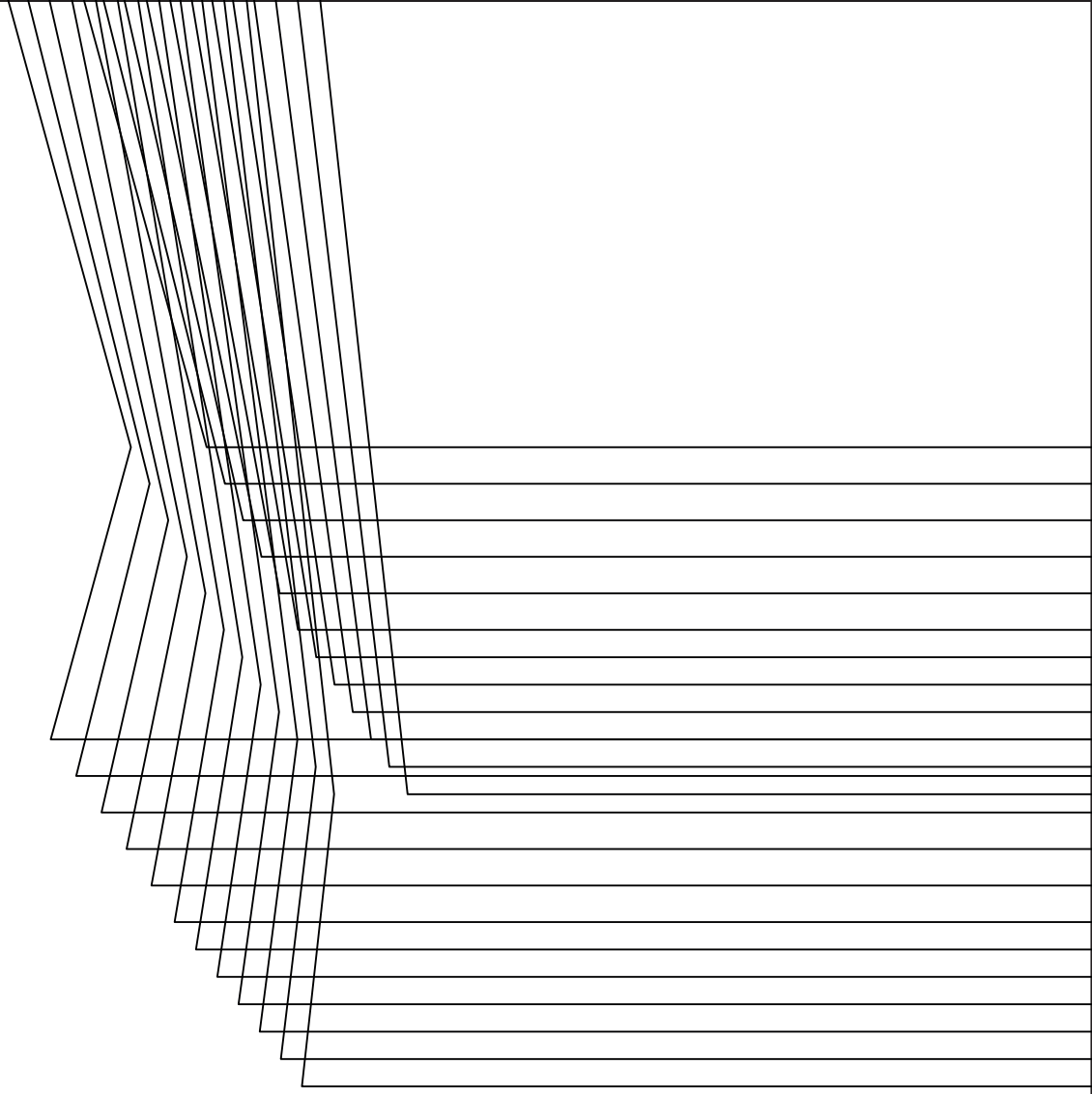

30

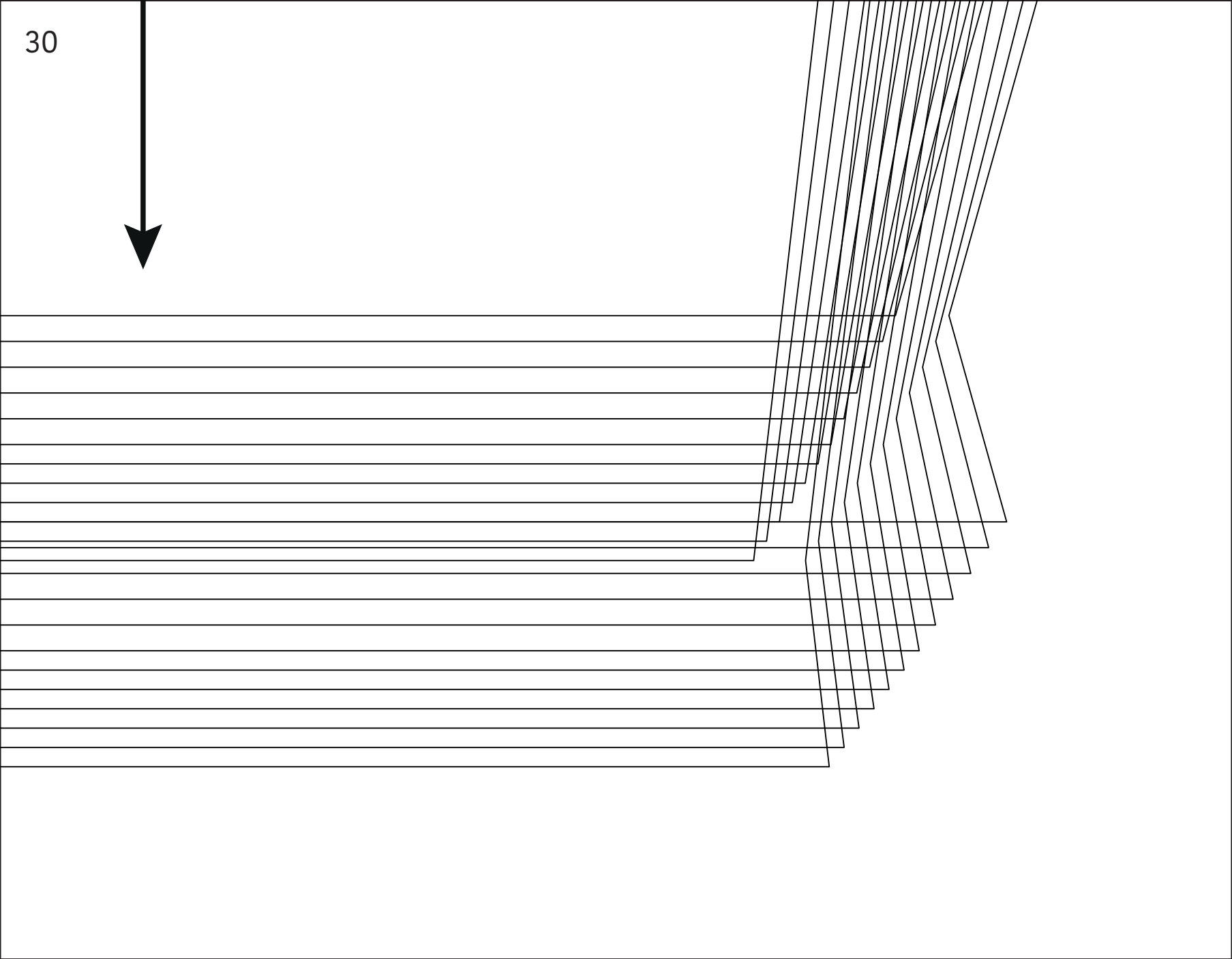

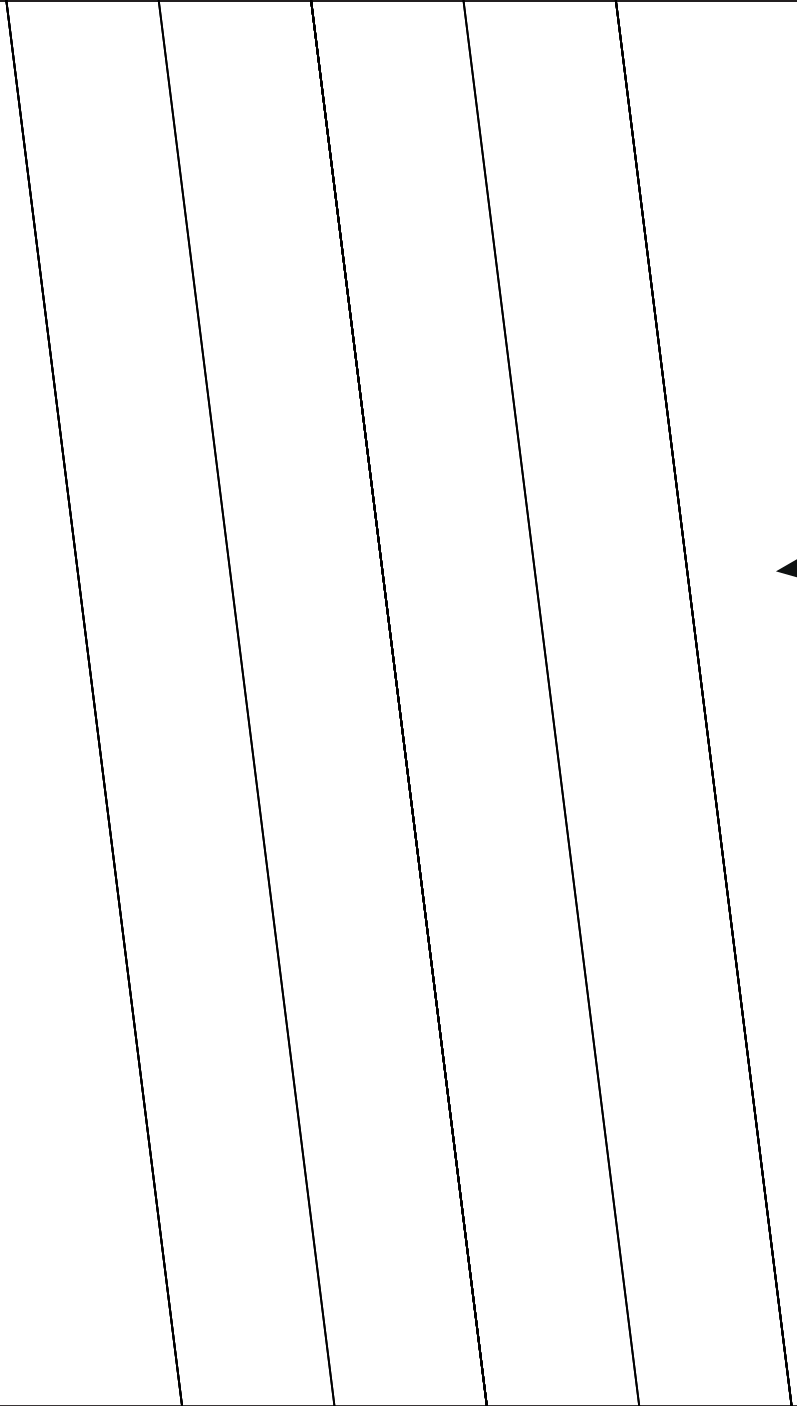

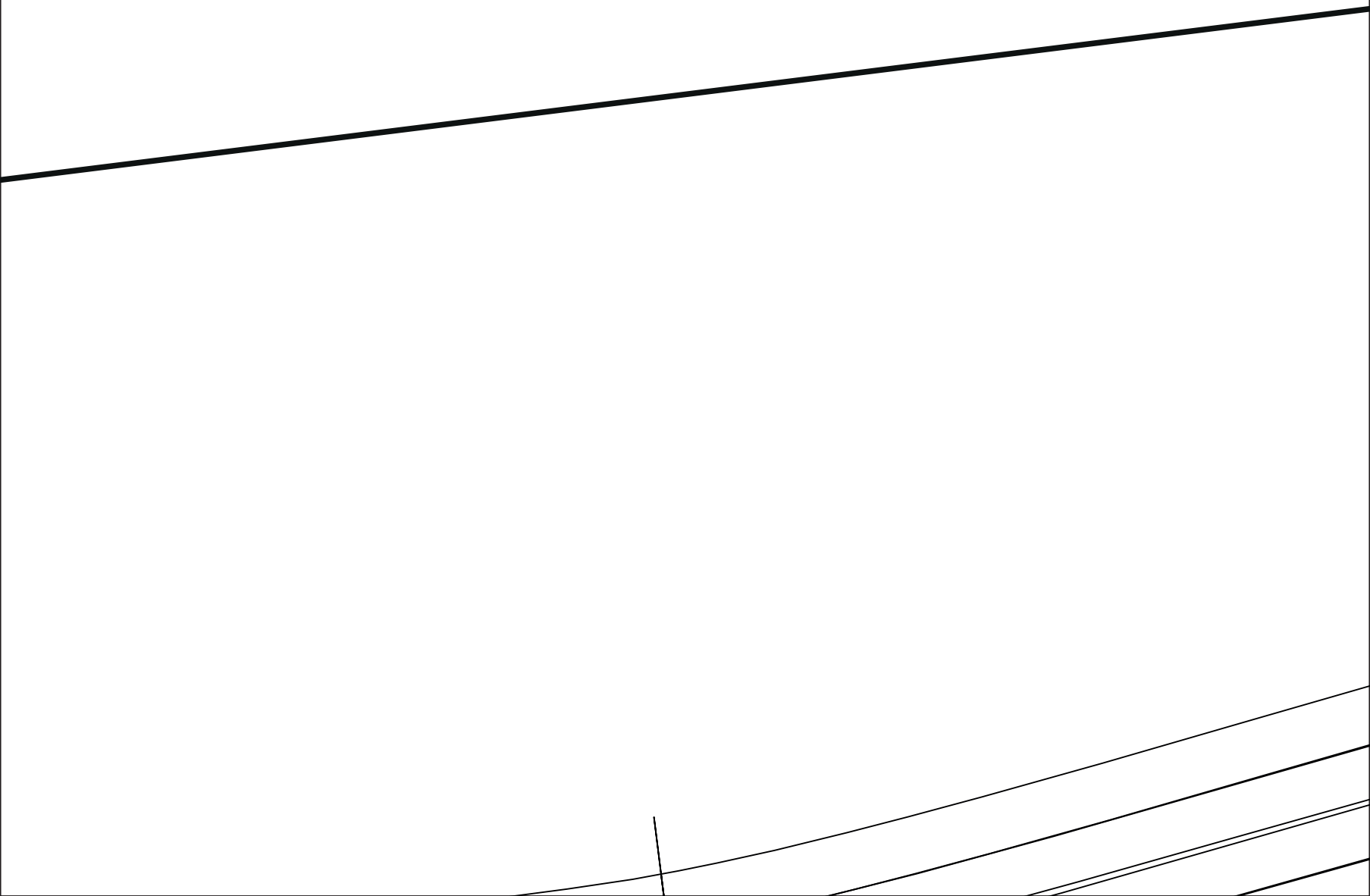



A

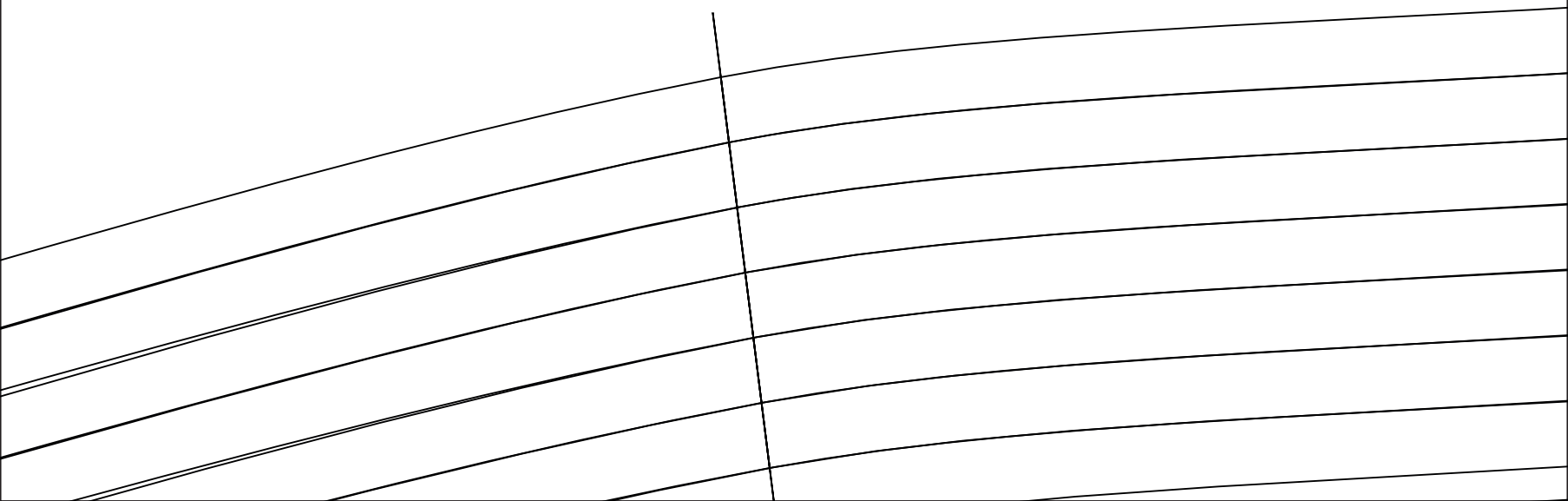

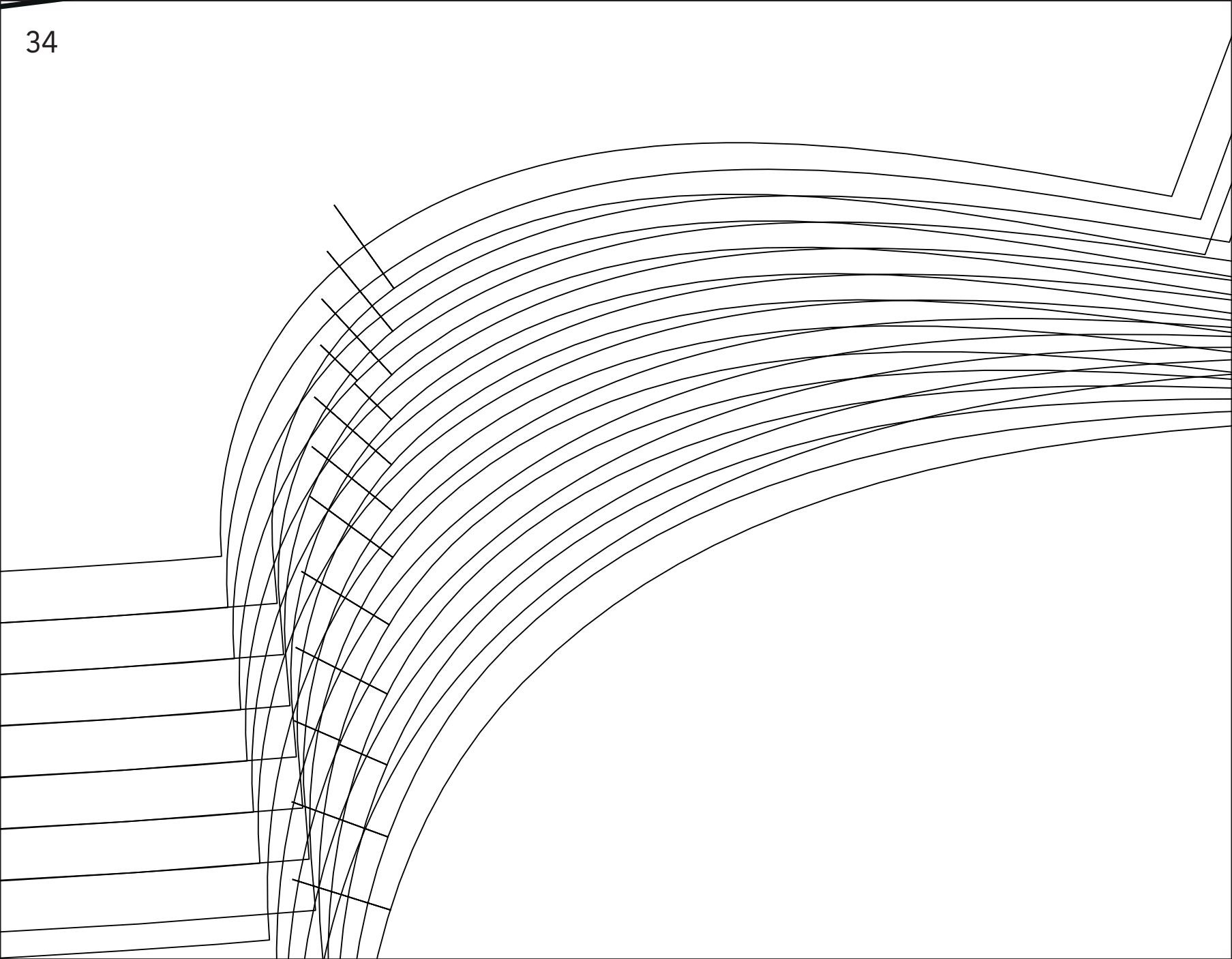

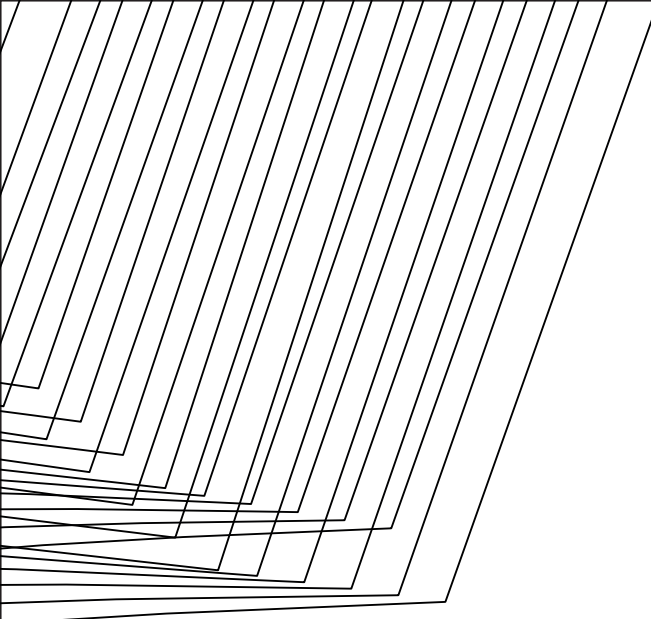







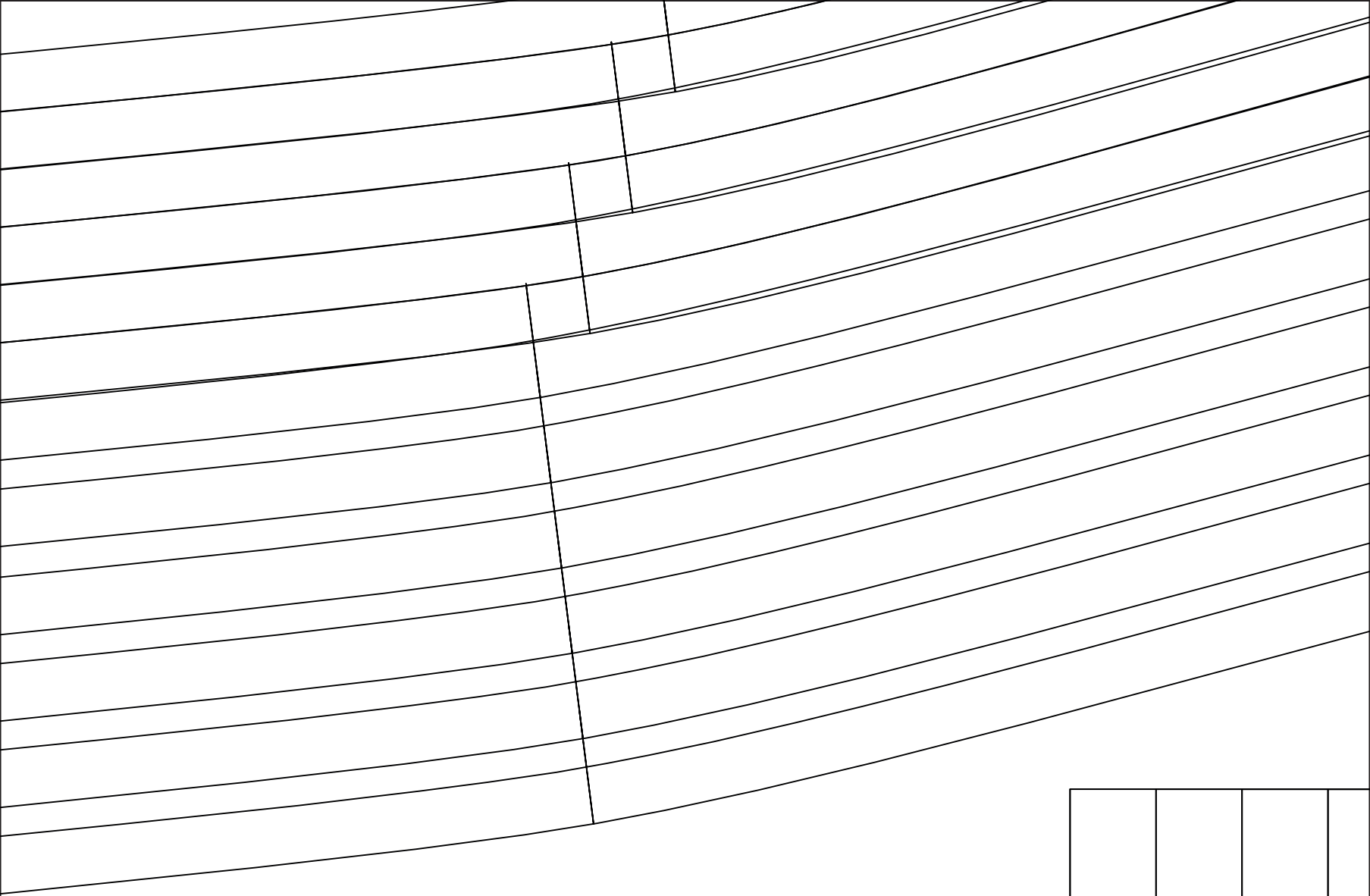

--	--	--	--

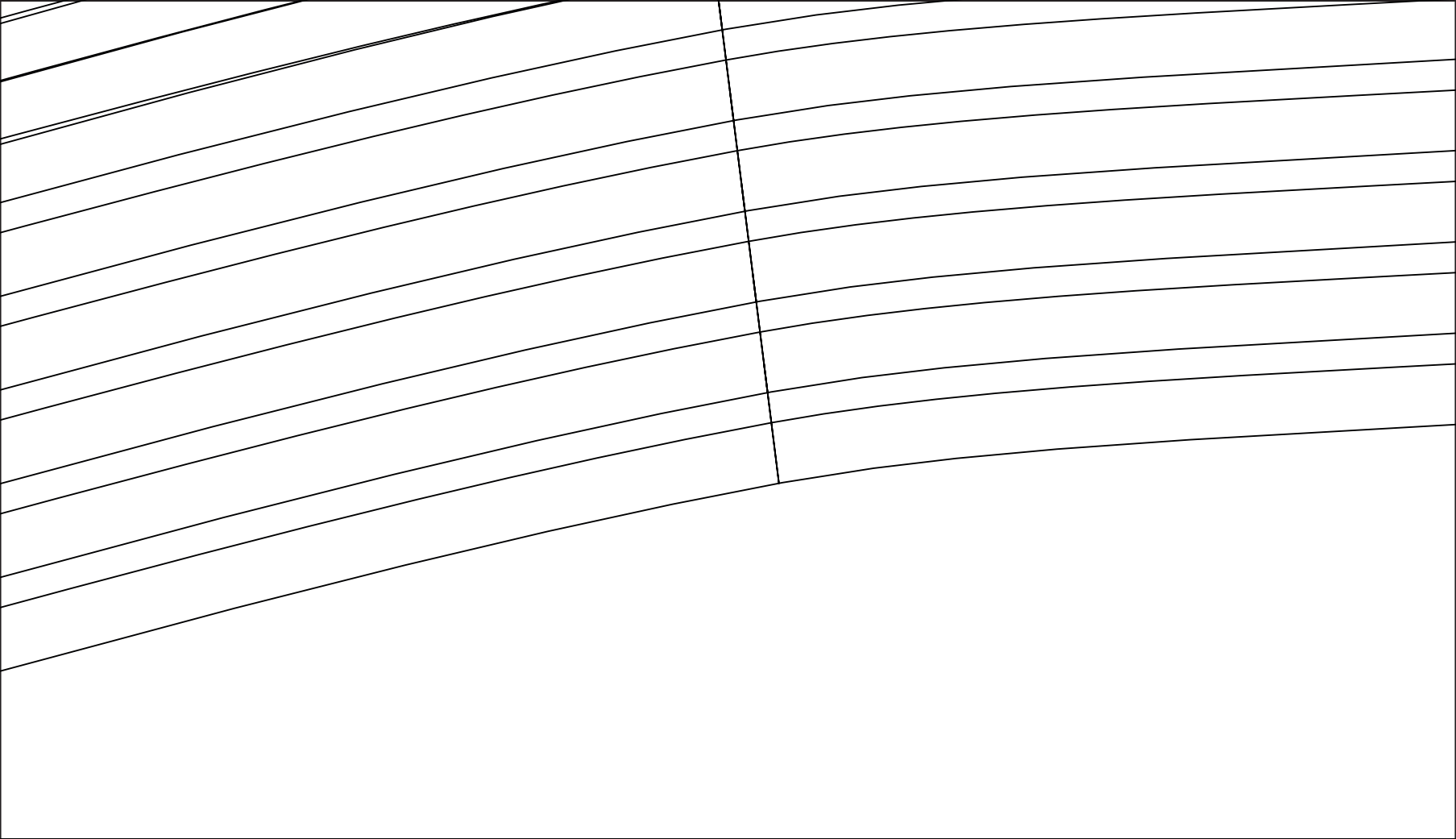

--	--	--	--	--	--	--	--	--

\_\_\_\_\_ **F**



