

Patroonschema / Schéma du Patron / Pattern Diagram /  
Übersichtsplan zum Zusammenkleben

## Camilla

Jurk / Robe /  
Dress / Kleid

Patroondelen / Pièces du patron /  
Pattern pieces / Schnittteile:

- A** voorpand bovenstuk / devant haut /  
front top piece / oberes Vorderteil
- A'** voorpand bovenstuk voering / devant  
haut doublure / front top piece  
lining / Futter oberes Vorderteil
- B** voorpand rok / devant jupe /  
skirt front / Vorderteil Rock
- C** rugpand bovenstuk / dos haut /  
back top piece / oberes Rückenteil
- C'** Rugpand bovenstuk voering / Dos  
haut doublure / back top piece lining /  
Futter oberes Rückenteil
- D** rugpand rok / dos jupe / skirt back  
Rückenteil Rock

1	2	3	4	5	6	7
8	9	10	11	12	13	14
15	16	17	18	19	20	21
22	23	24	25	26	27	28
29	30	31	32	33	34	35
36	37	38	39	40	41	42

Controlevierkant / Carré de controle  
/ Test square / Kontrollquadrat

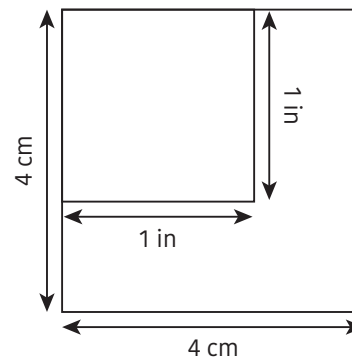

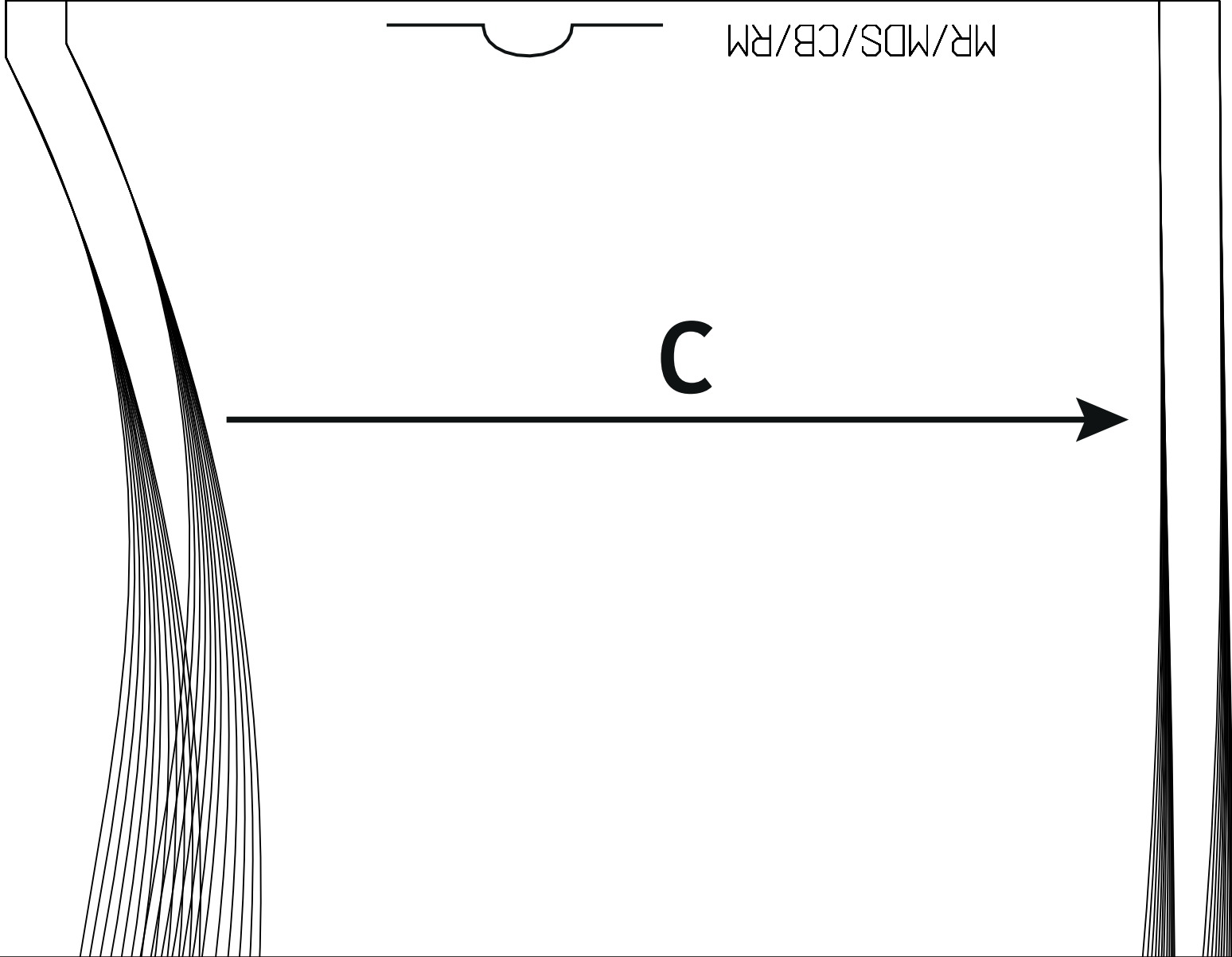

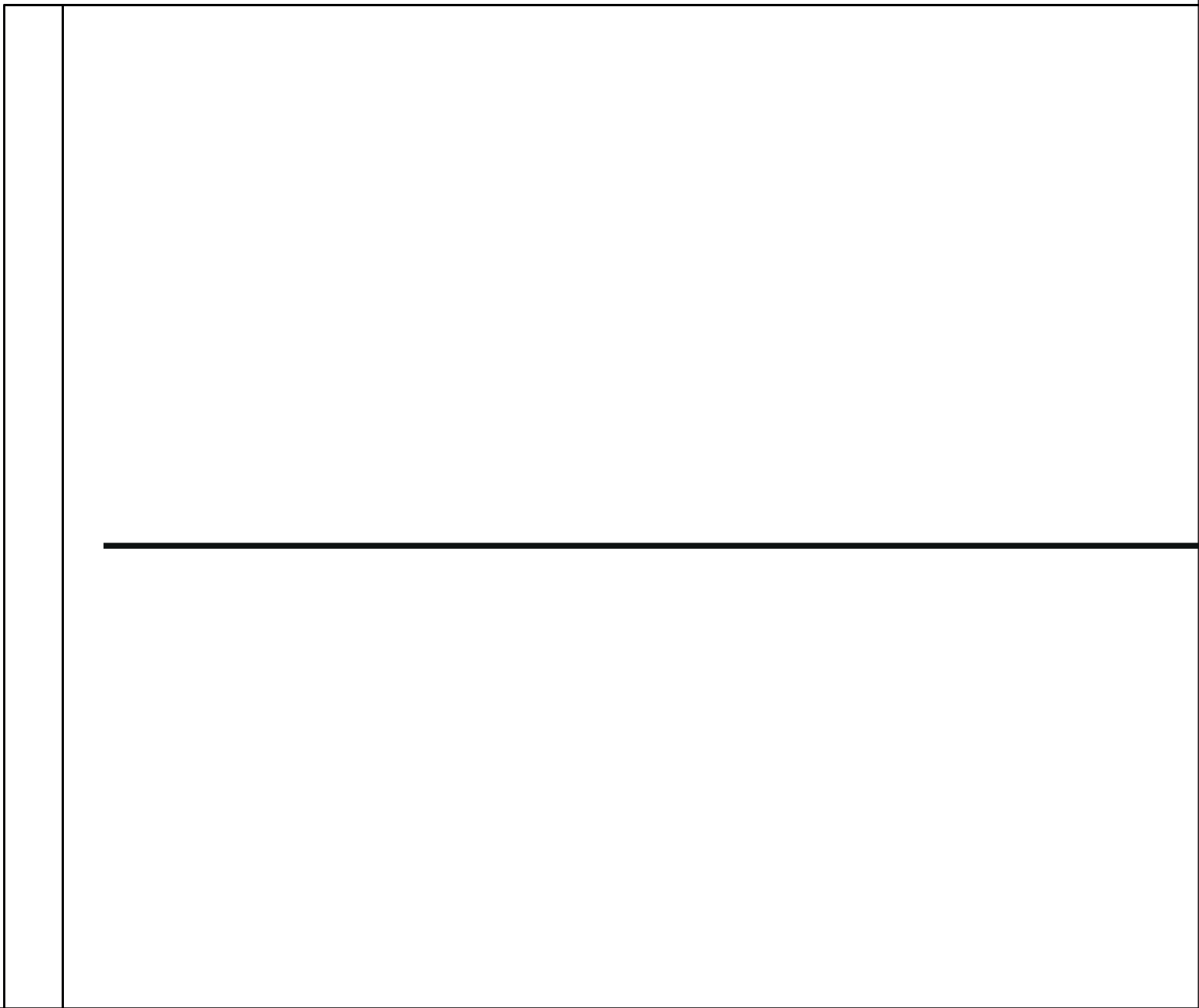



MR/MDS

**D**



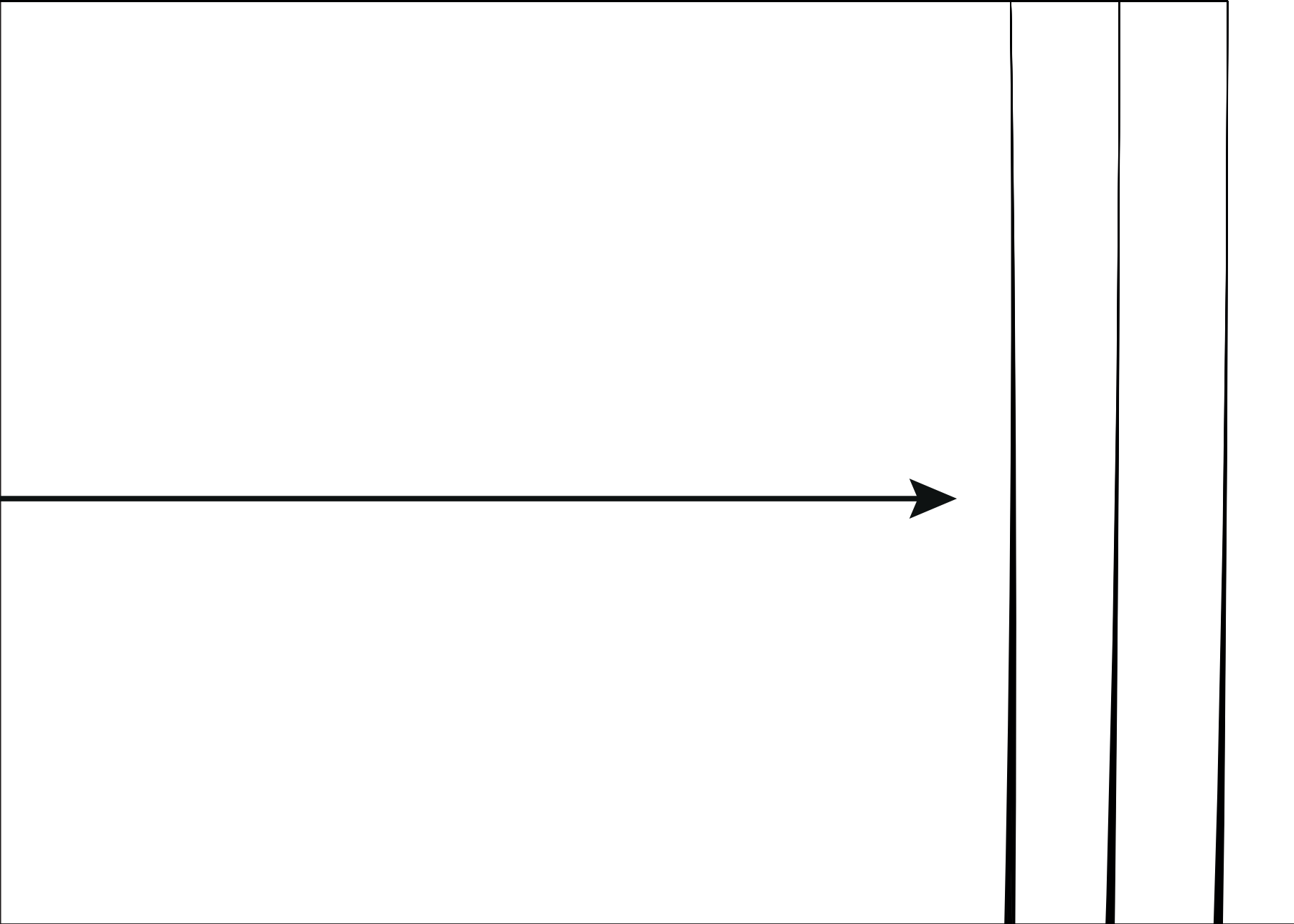

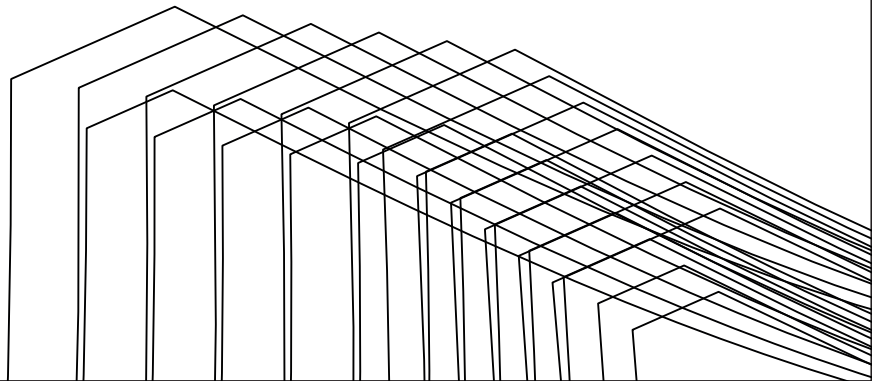



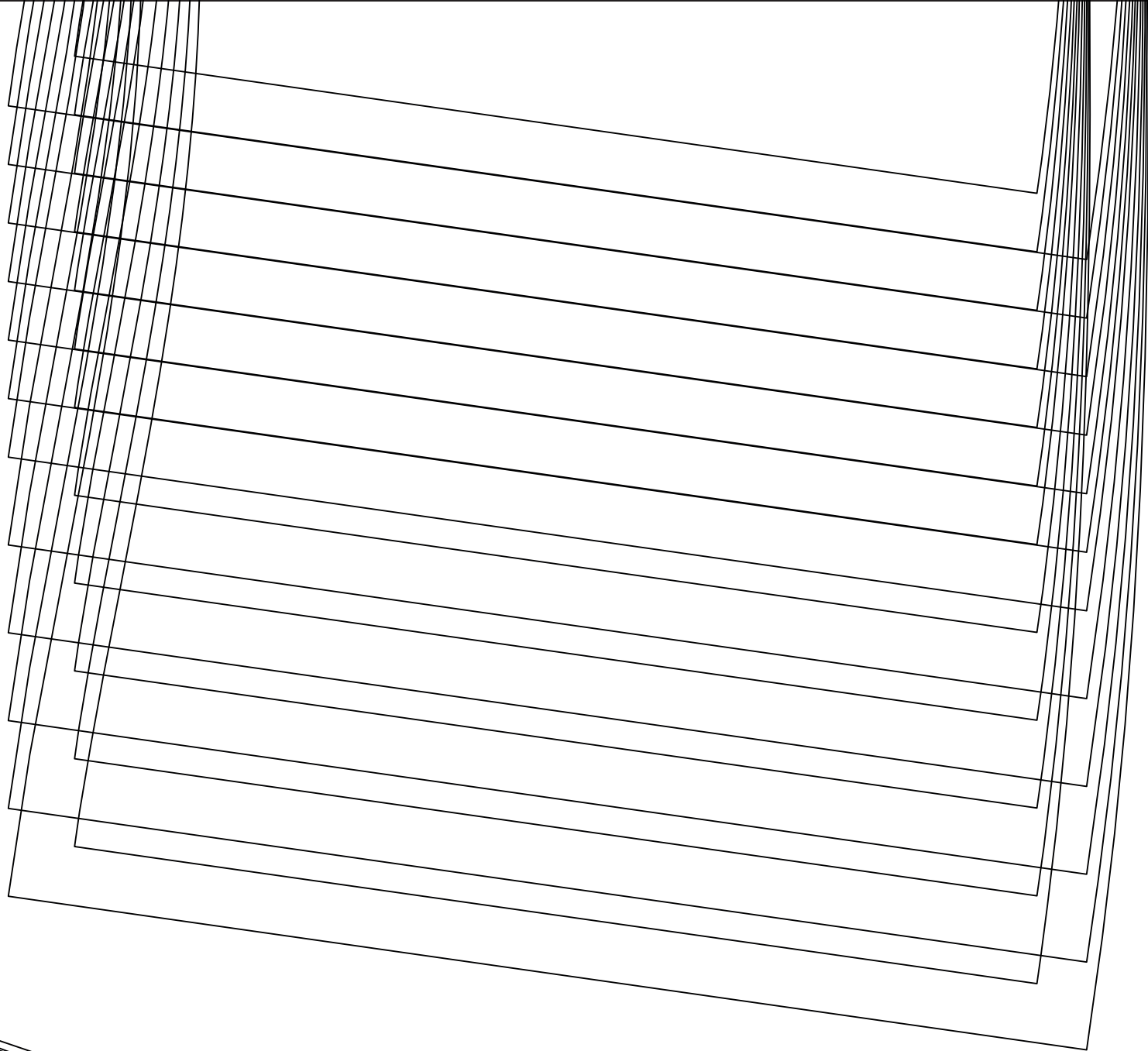

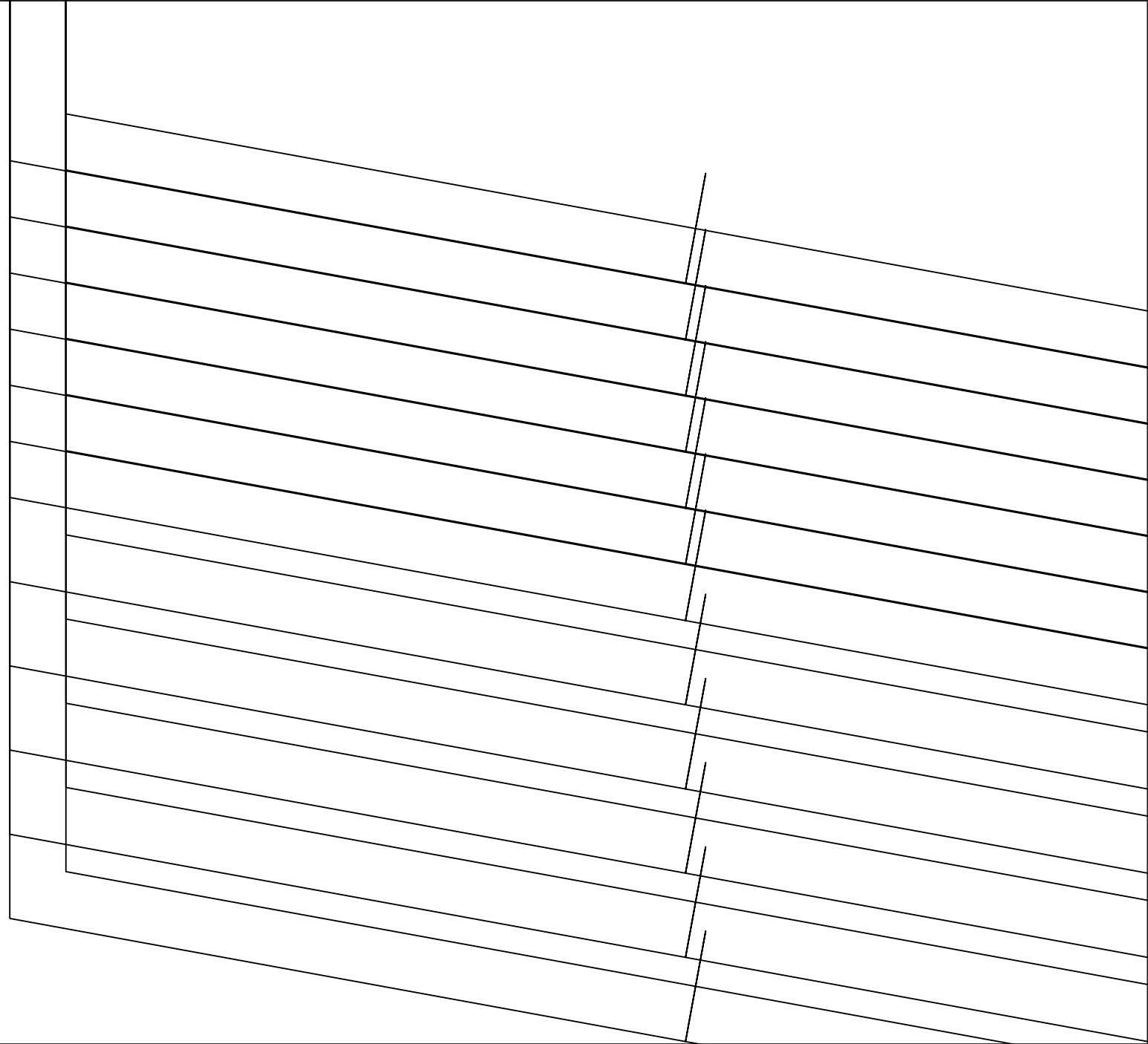

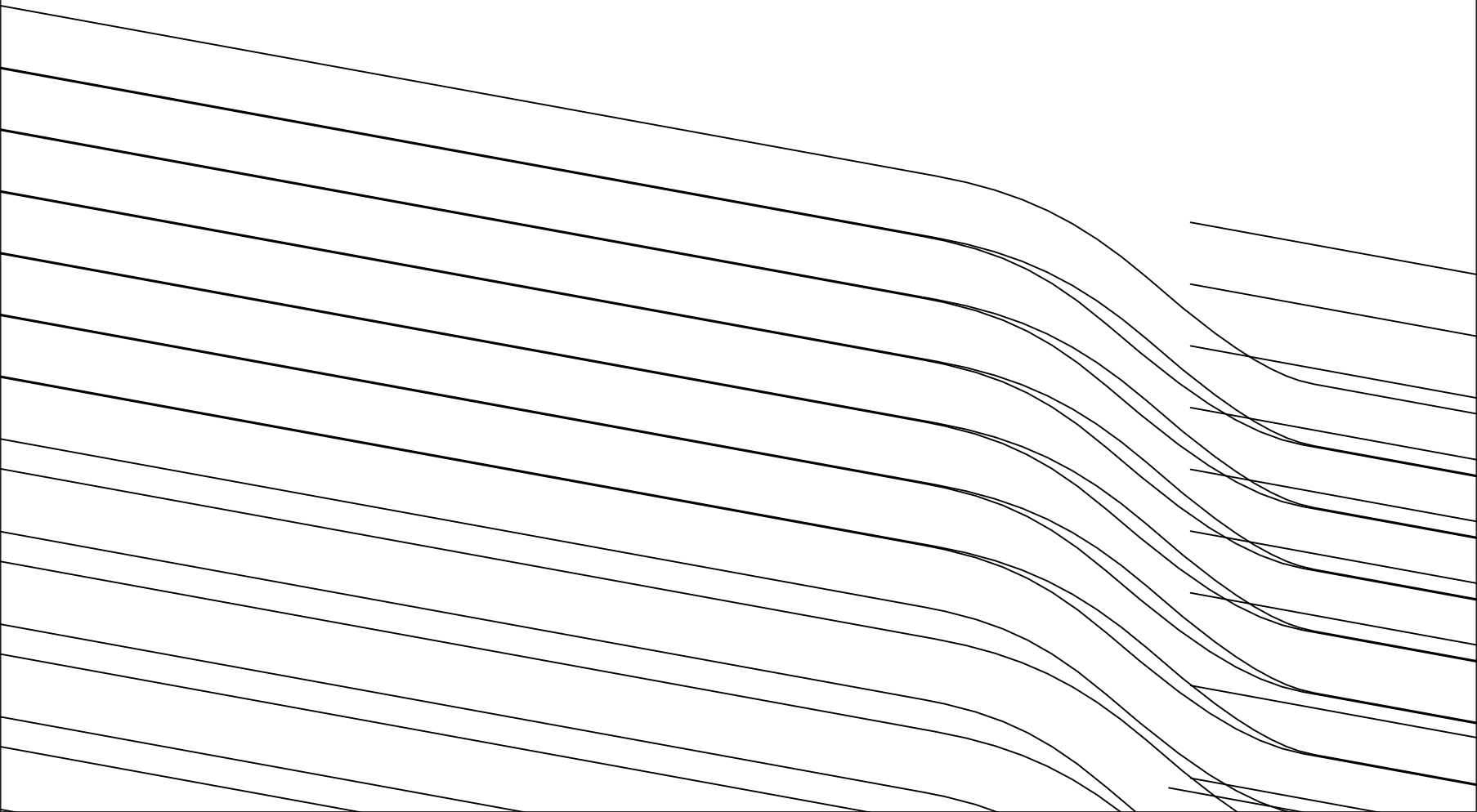

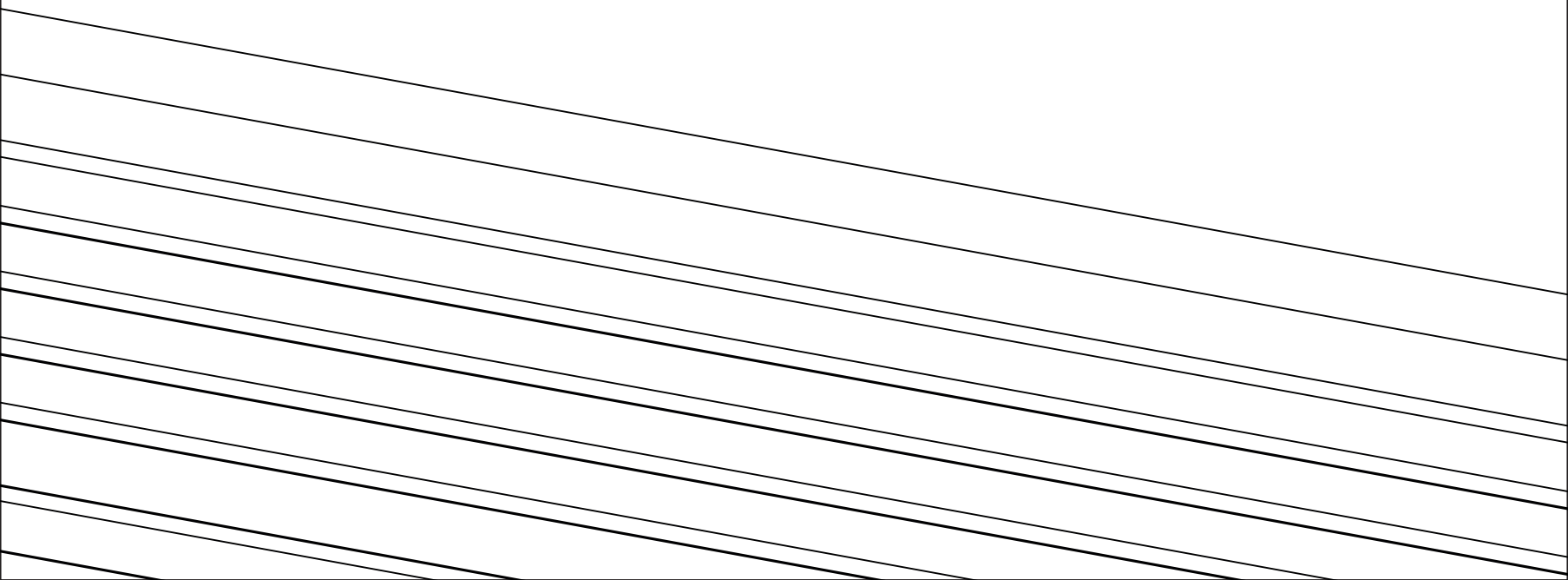

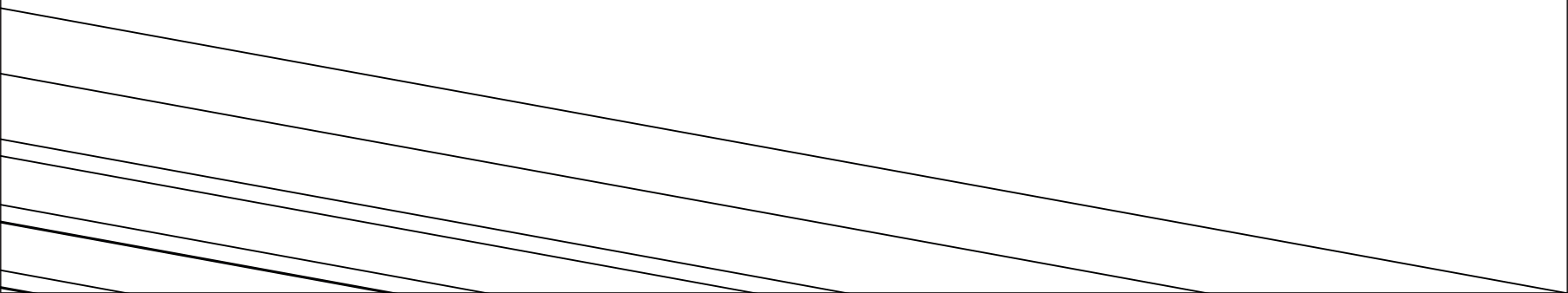



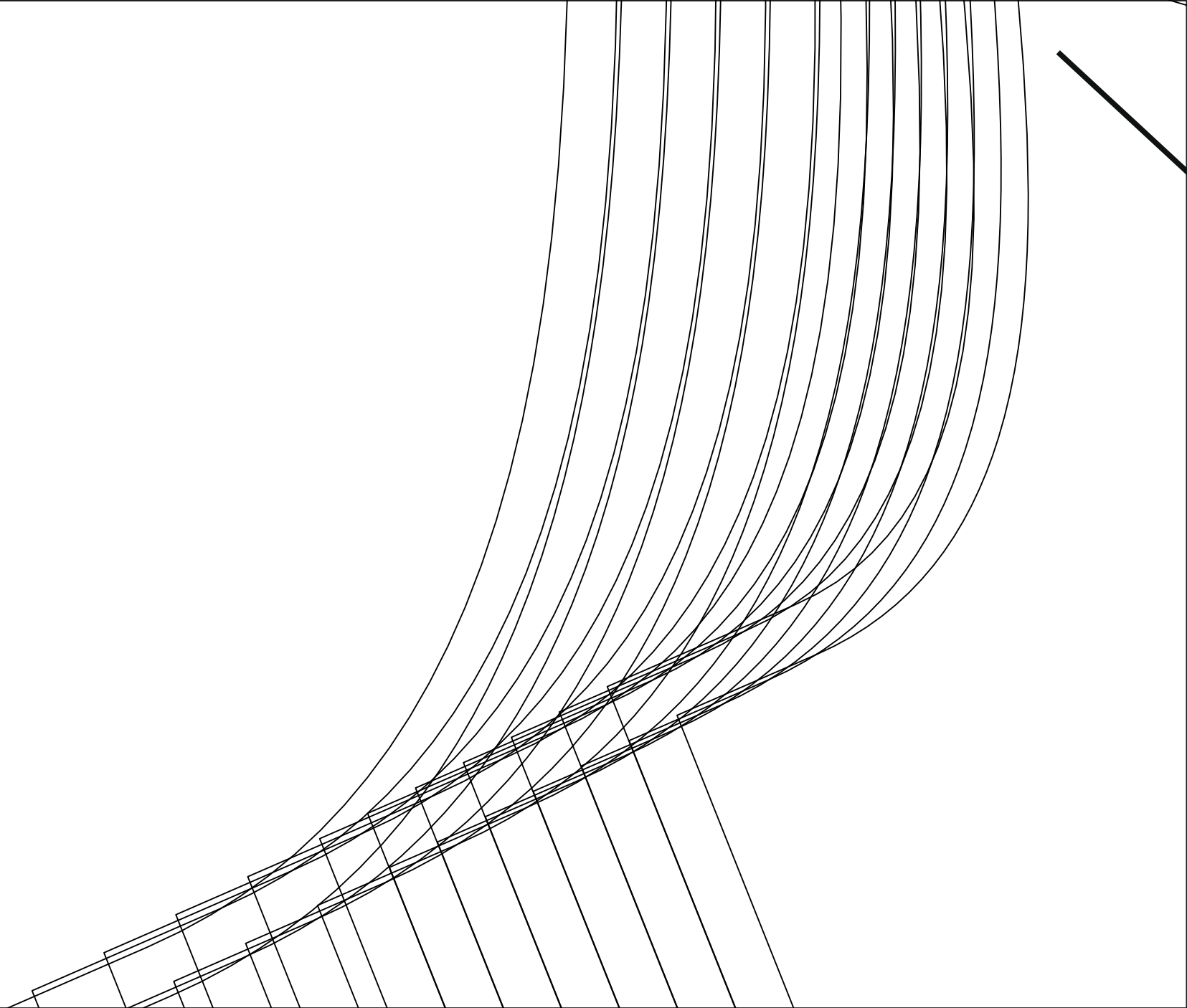

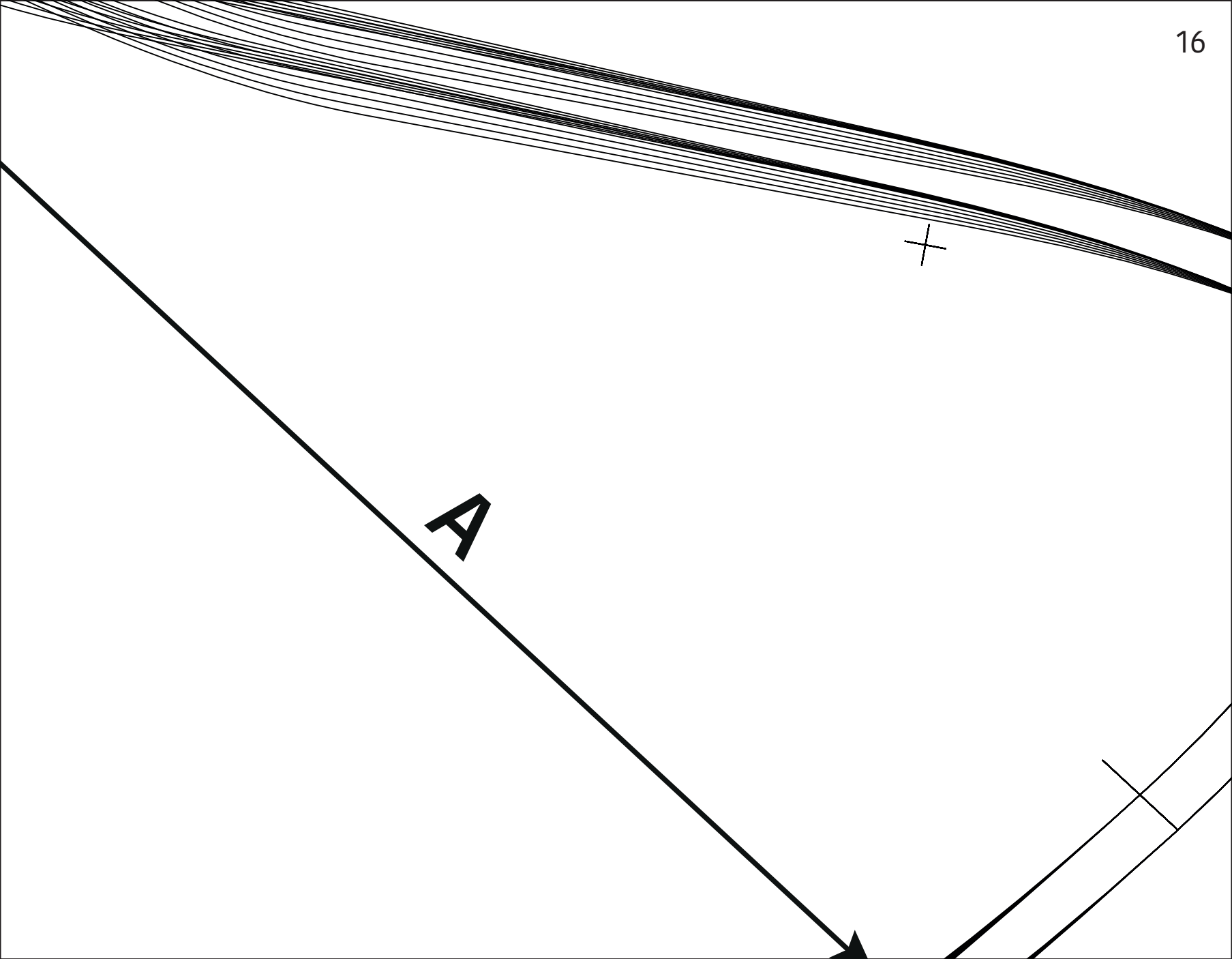



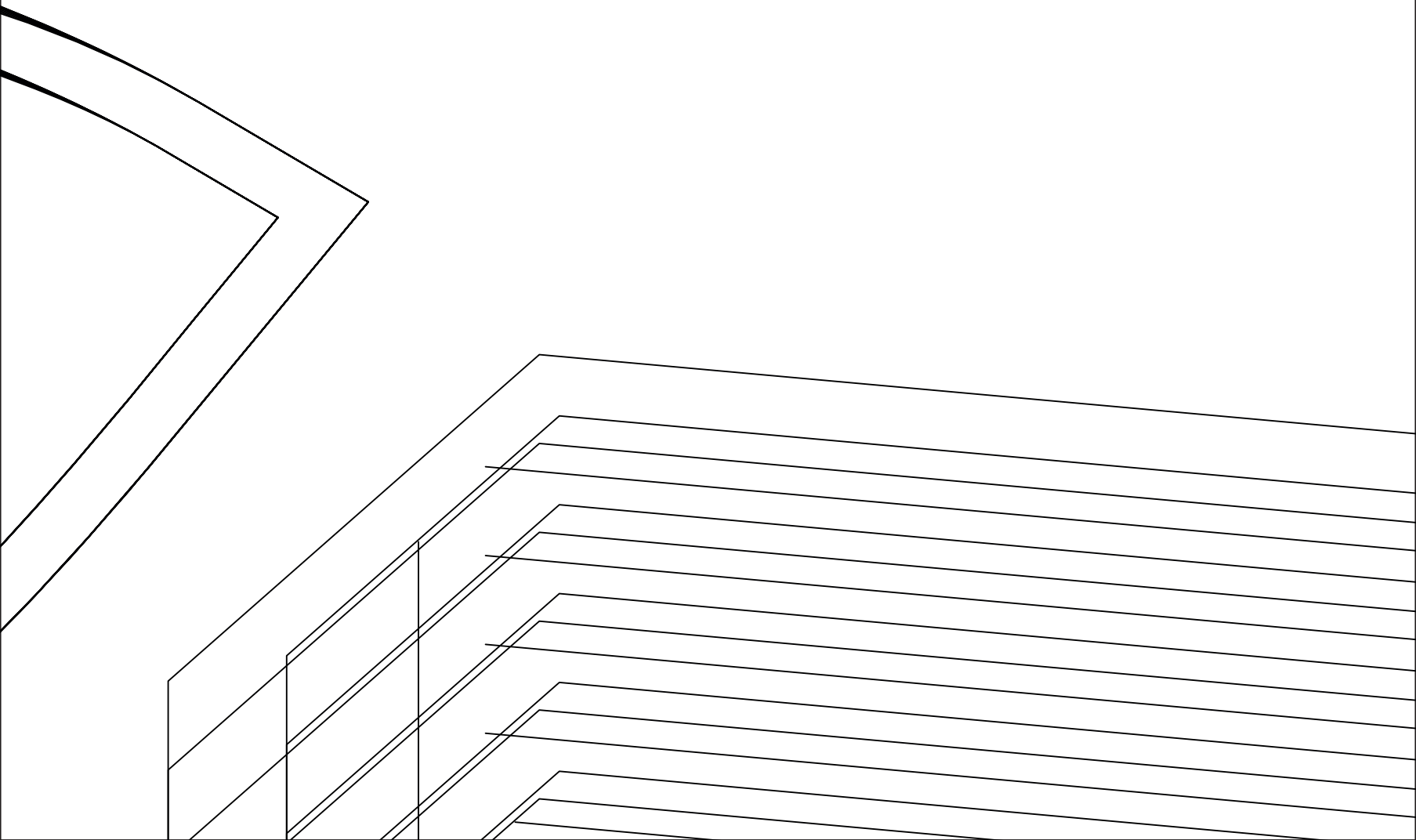

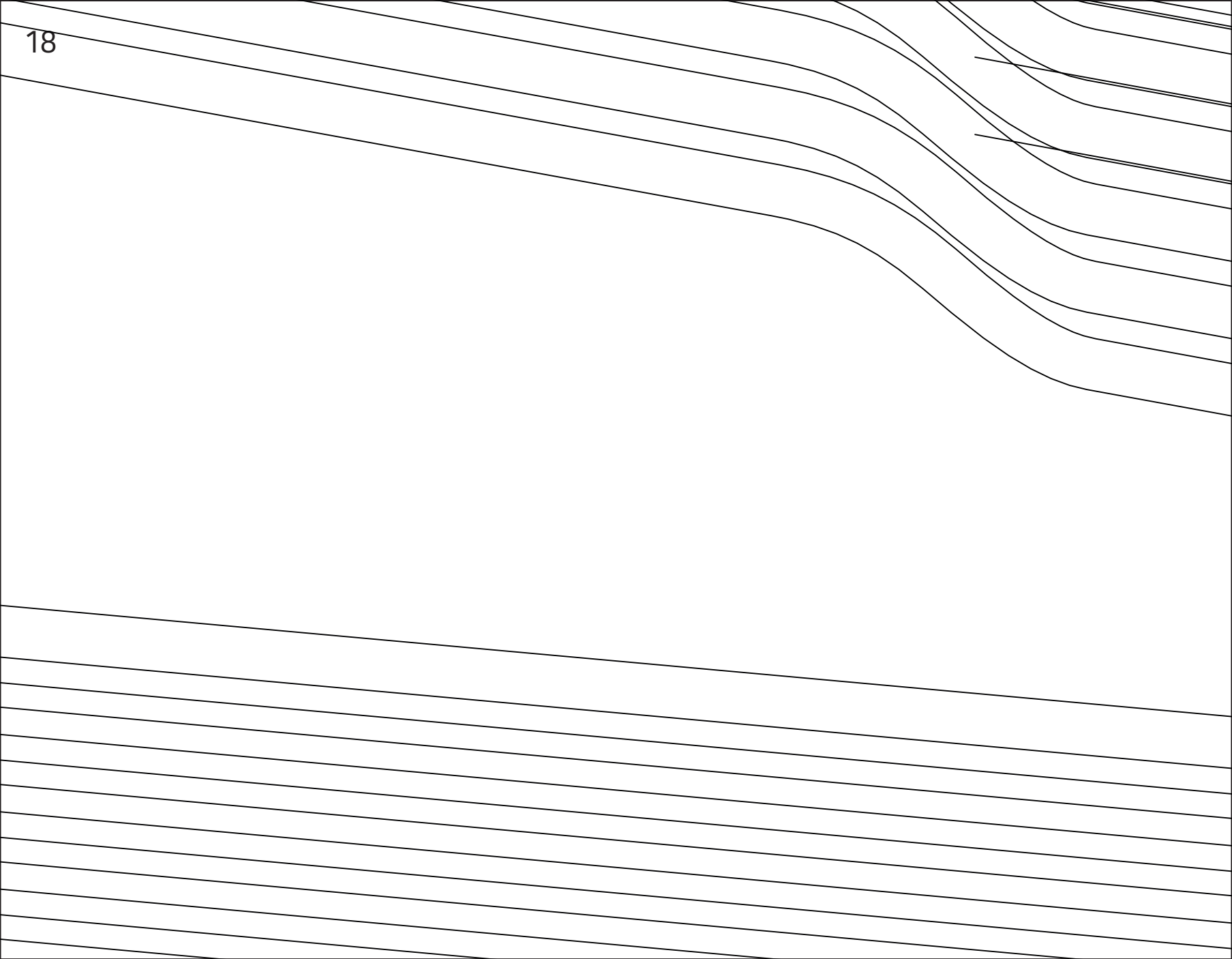

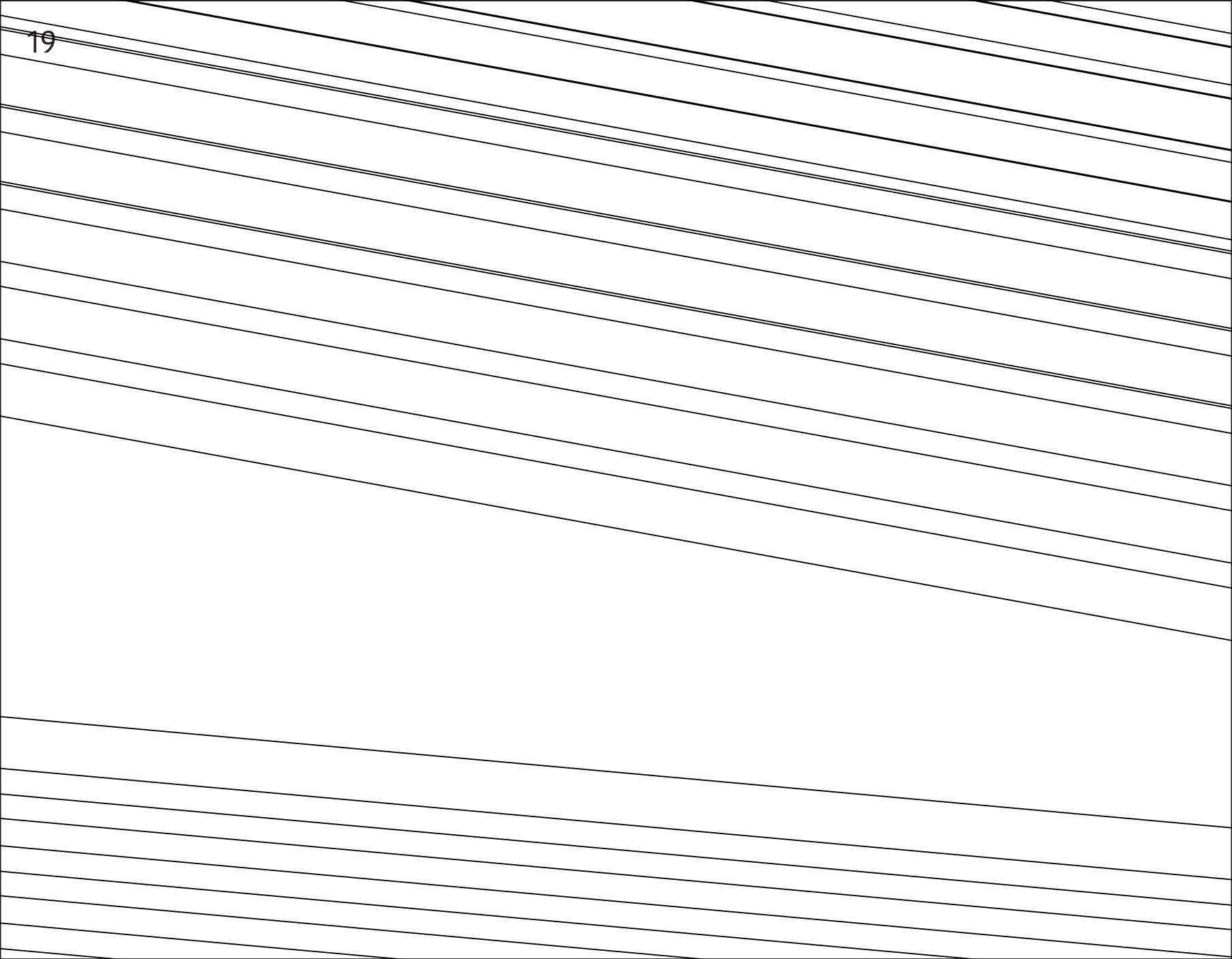

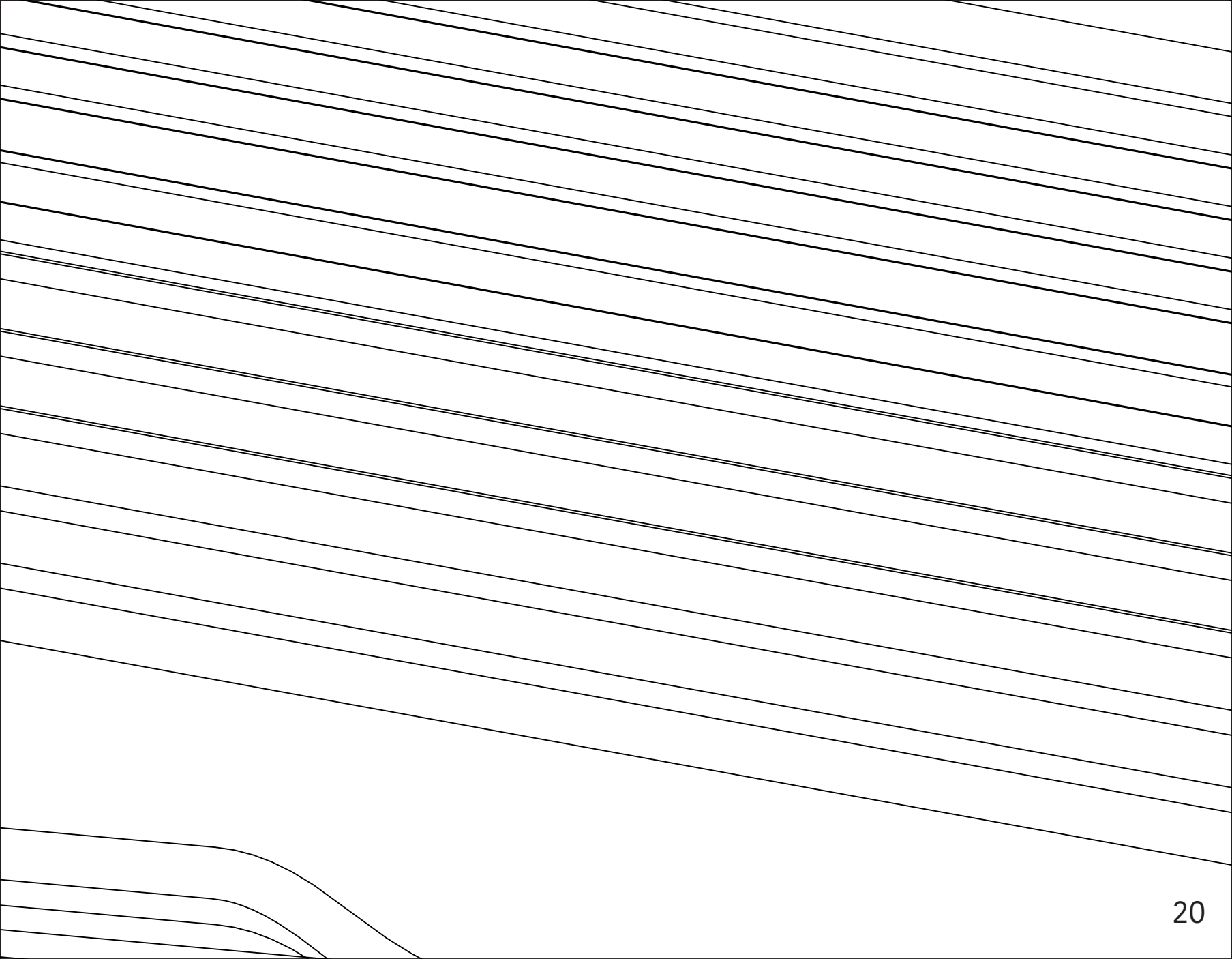

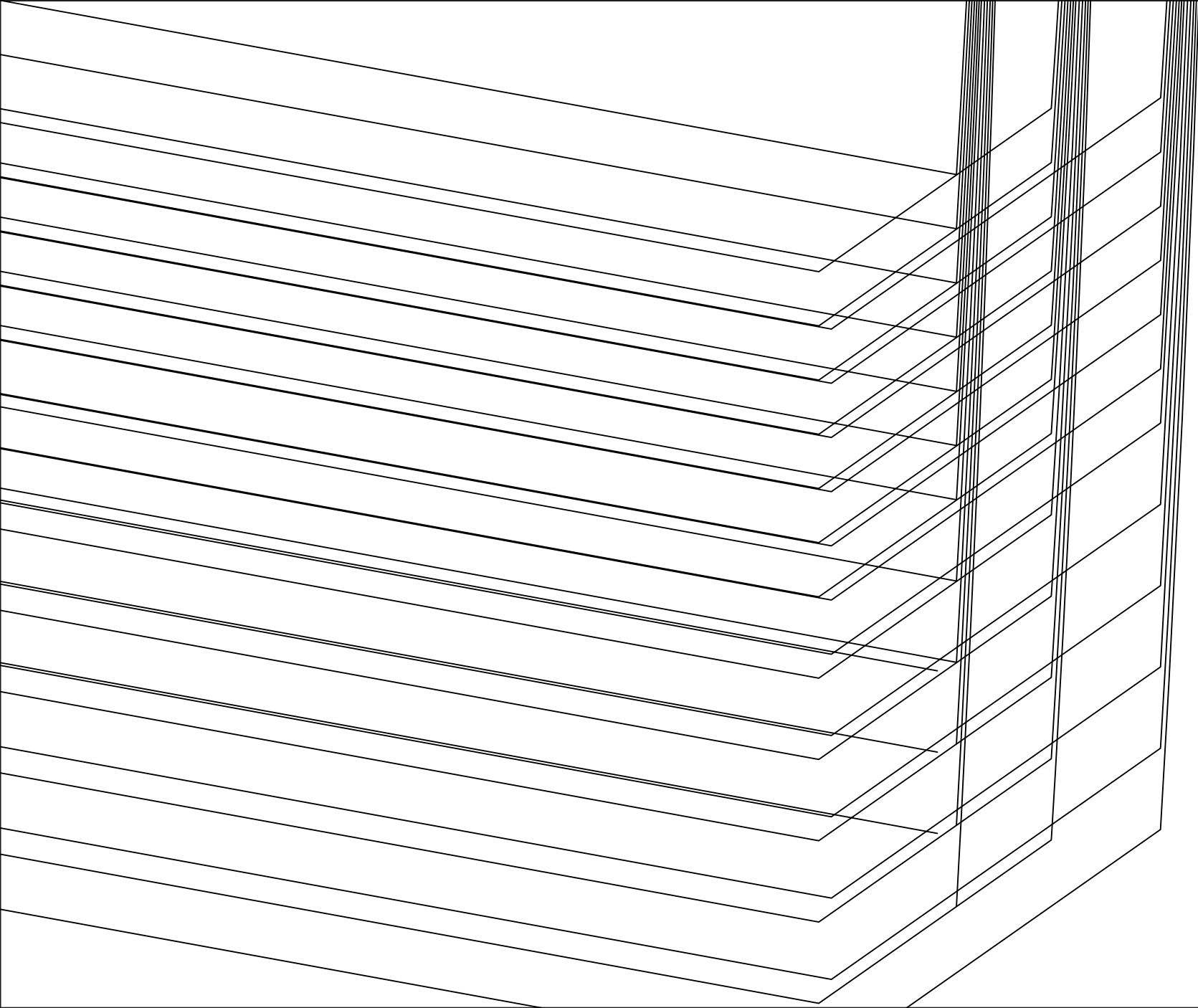

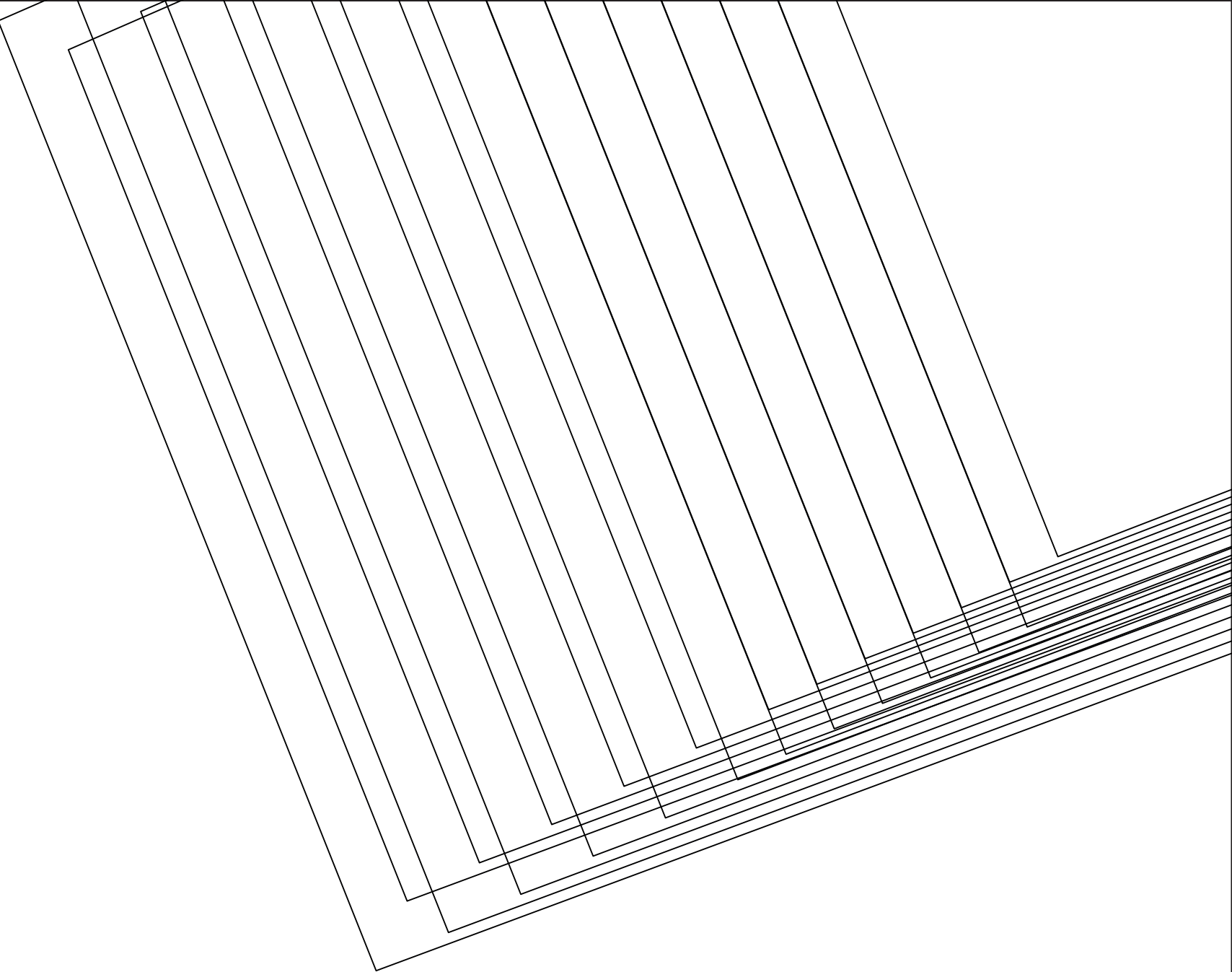

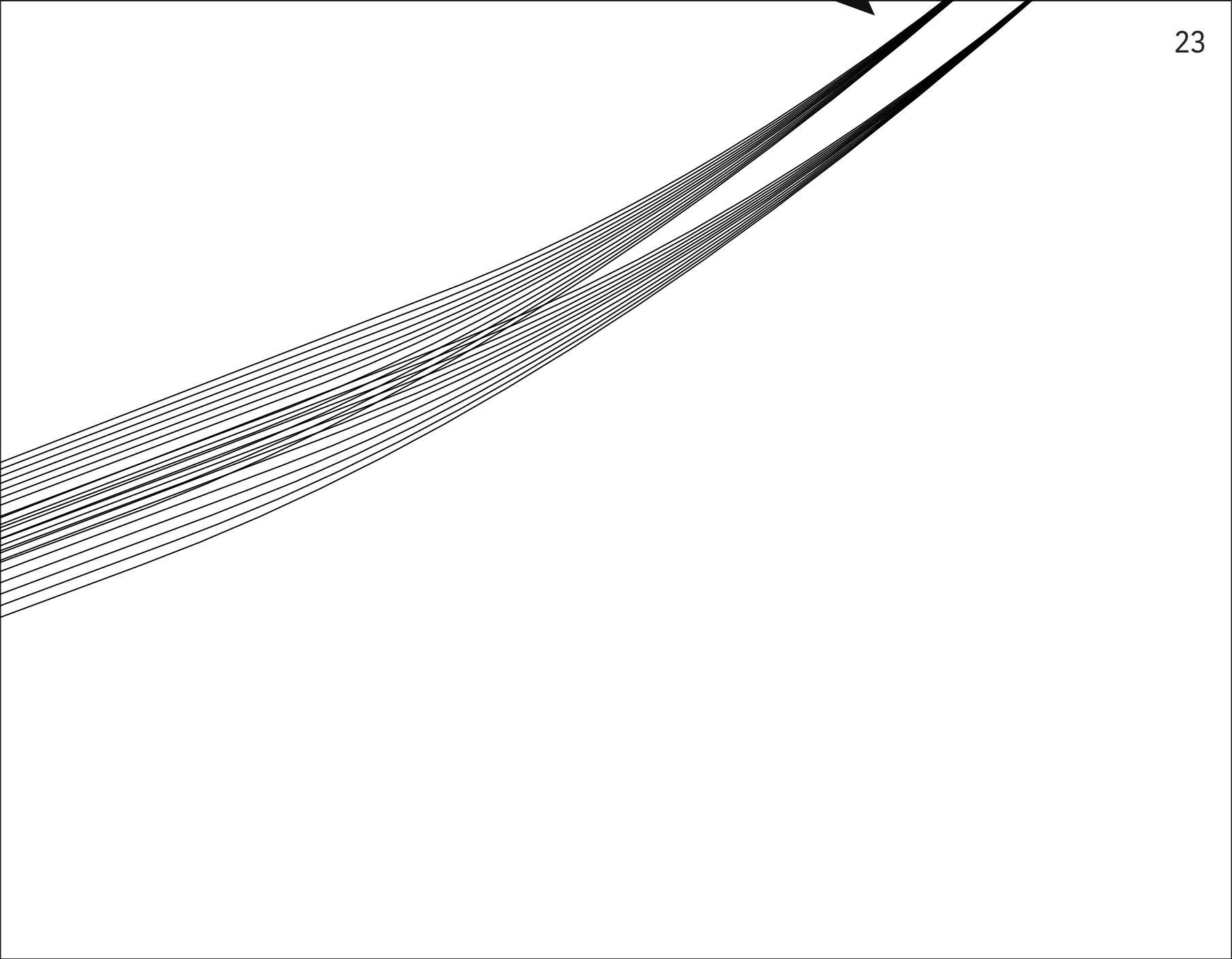

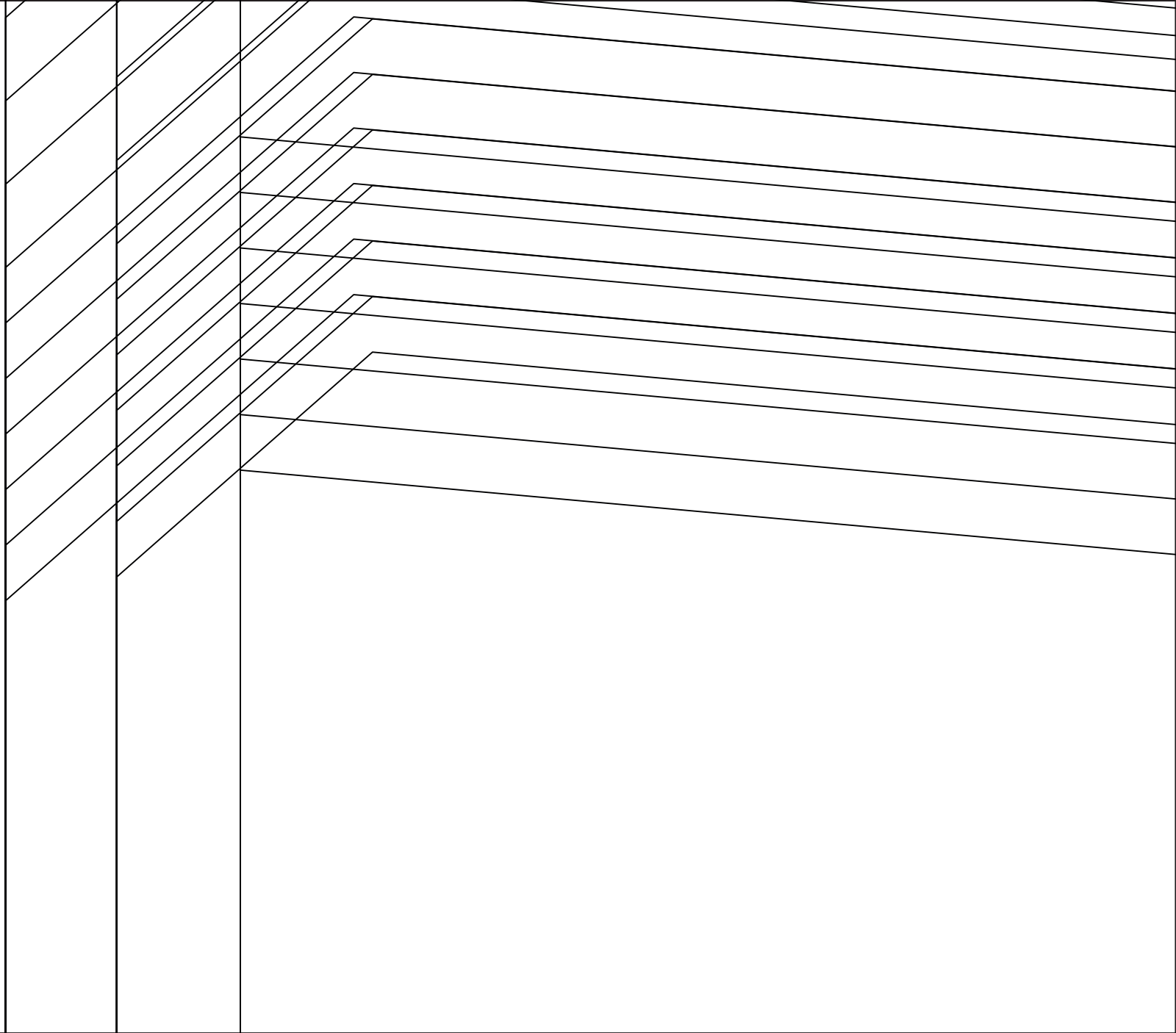



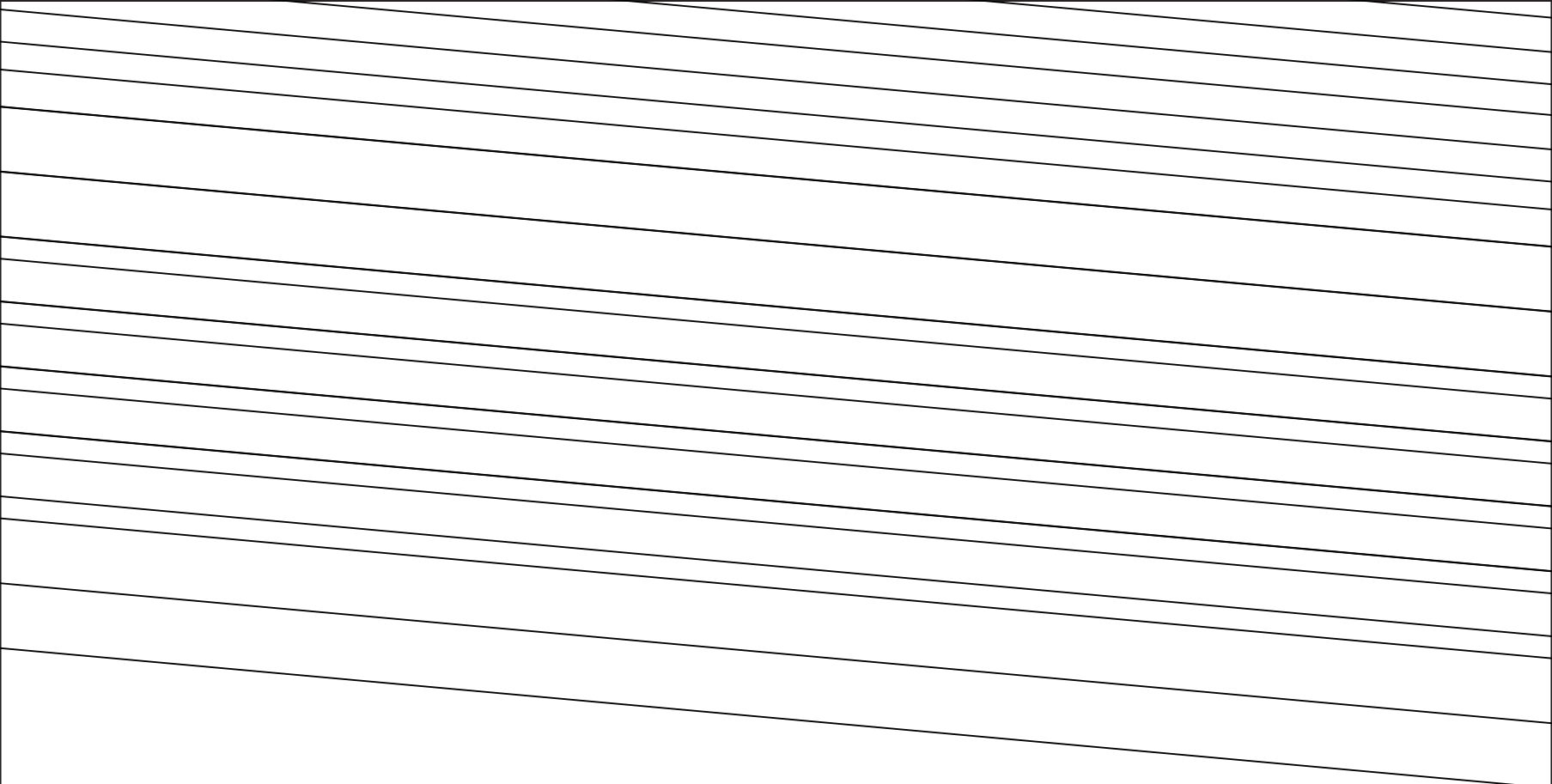

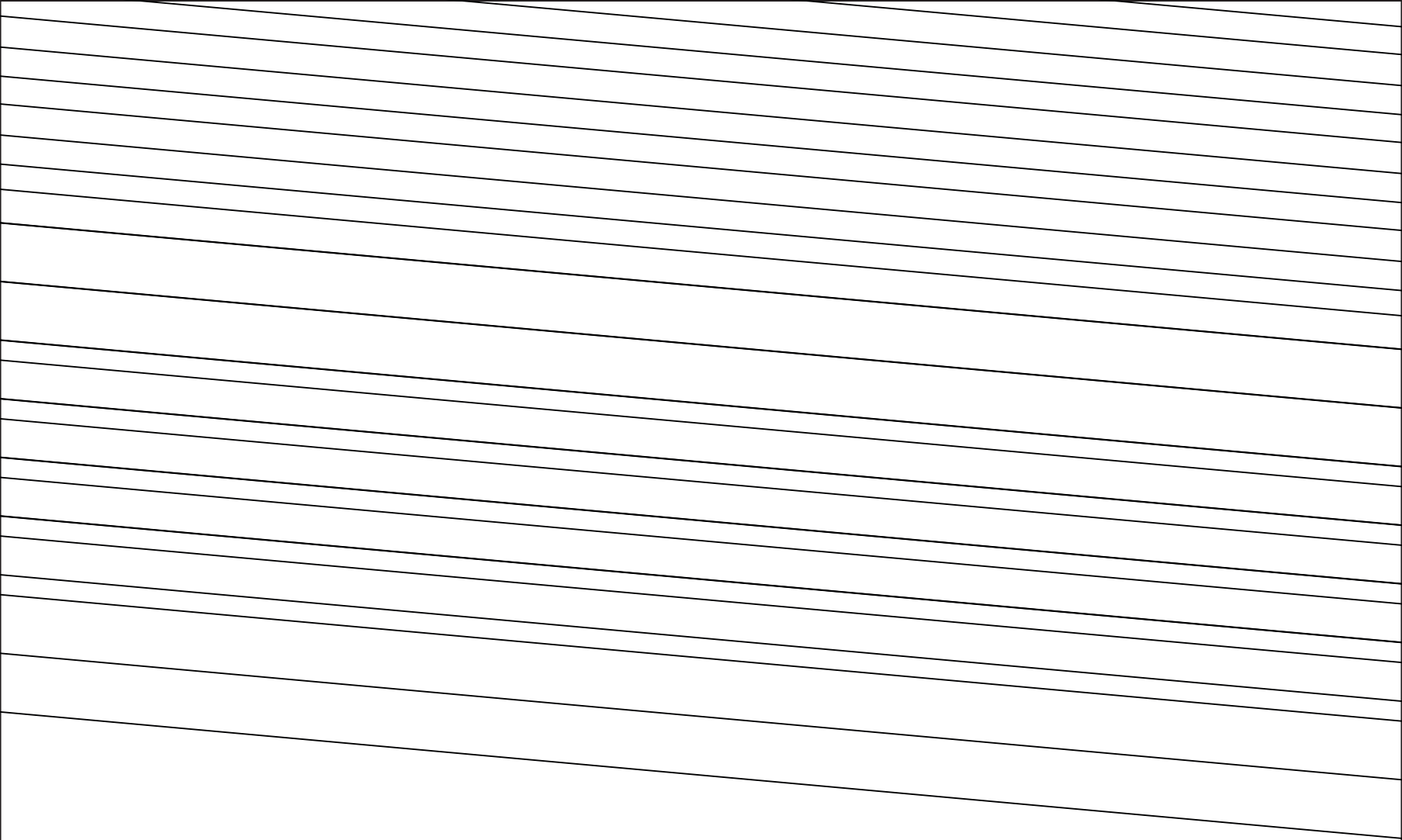

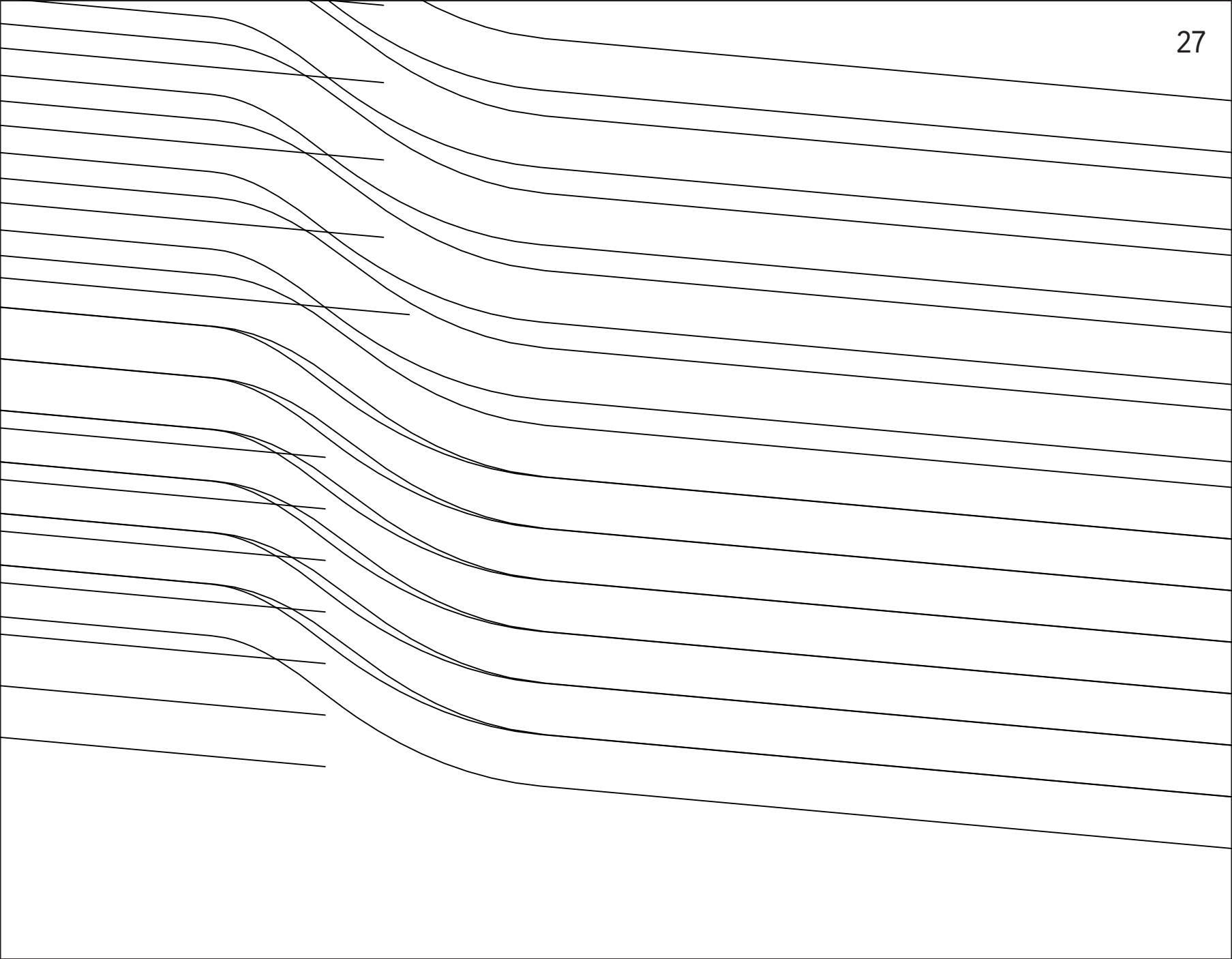

The image shows a large, empty table with a grid of approximately 15 columns and 15 rows. A prominent vertical line runs down the center of the table, dividing it into two main sections. The table is mostly blank, with only a few faint horizontal lines visible in the rightmost column, possibly indicating data points or markers. The overall appearance is that of a blank ledger or data sheet.





31











---





--	--	--	--







MV/MDV/CF/VM 

