

Patroonschema / Schéma du Patron / Pattern Diagram /
Übersichtsplan zum Zusammenkleben

Cecile

Jurk / Robe /
Dress / Kleid

Patroondelen / Pièces du patron /
Pattern pieces / Schnittteile:

- A** voorpand / devant / front panel /
Vorderteil
- B** rugpand / dos / back panel /
Rückenteil
- C** mouw / manche / sleeves / Ärmel
- D** halsbeleg VP /
parementure encolure DV /
neckline facing FP / Halsbesatz VT
- E** halsbelg RP /
parementure encolure DV /
neckline facing BP / Halsbesatz RT
- F** armsgatbeleg VP / parementure
emmanchure DV / armhole facing FP /
Besatz Armausschnitt VT
- G** armsgatbeleg RP / parementure
emmanchure DS / armhole facing BP /
Besatz Armausschnitt RT

1	2	3	4	5	6
7	8	9	10	11	12
13	14	15	16	17	18
19	20	21	22	23	24
25					

Controlevierkant / Carré de controle
/ Test square / Kontrollquadrat

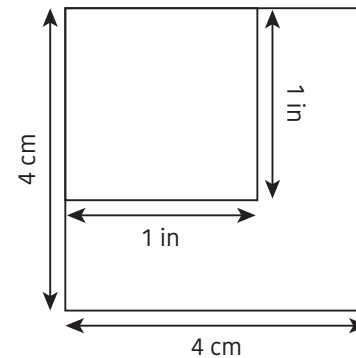

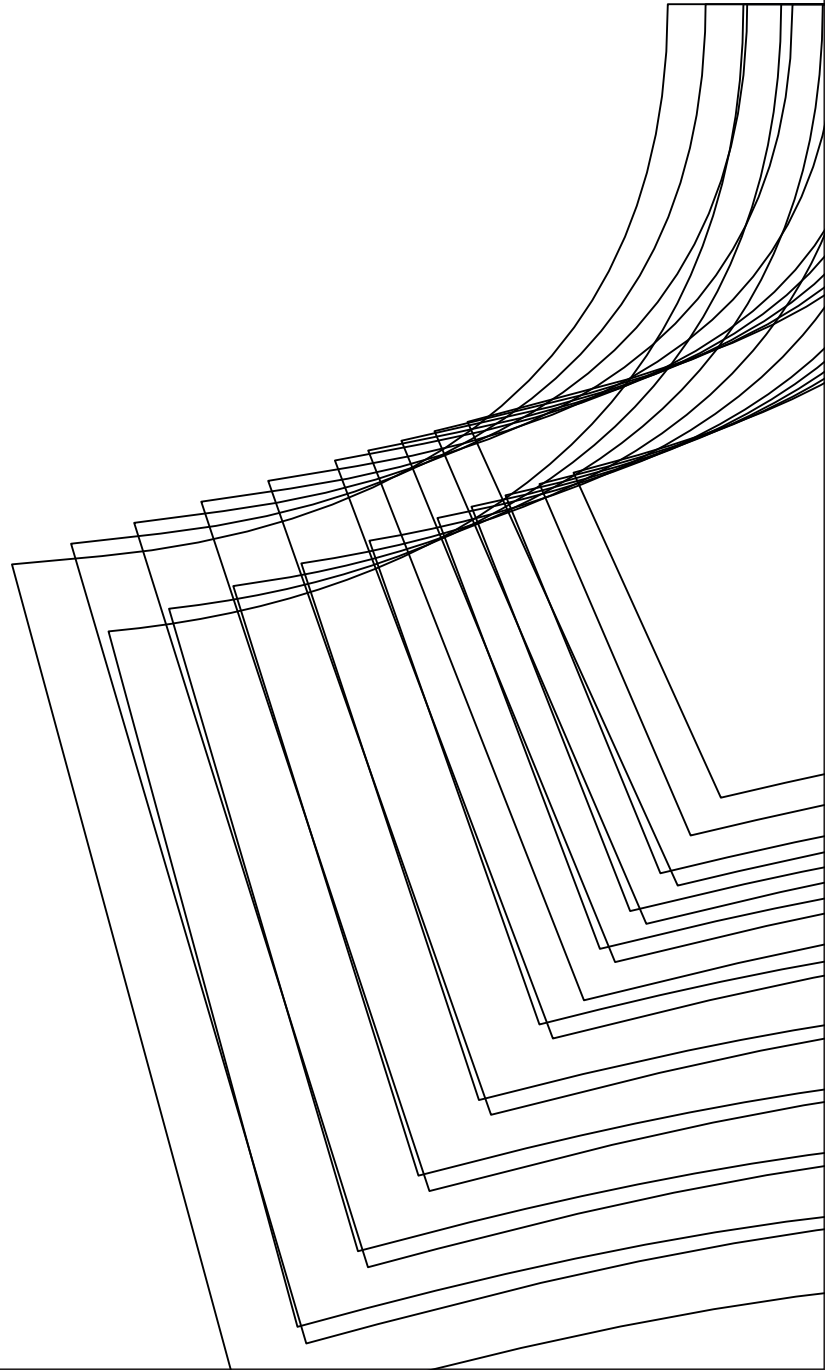
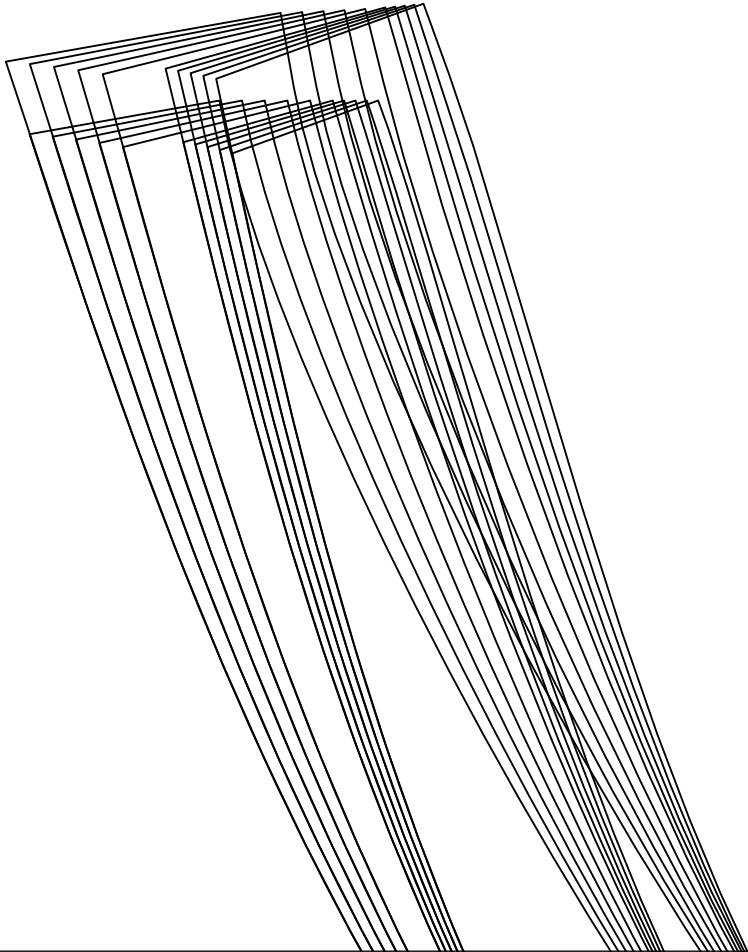

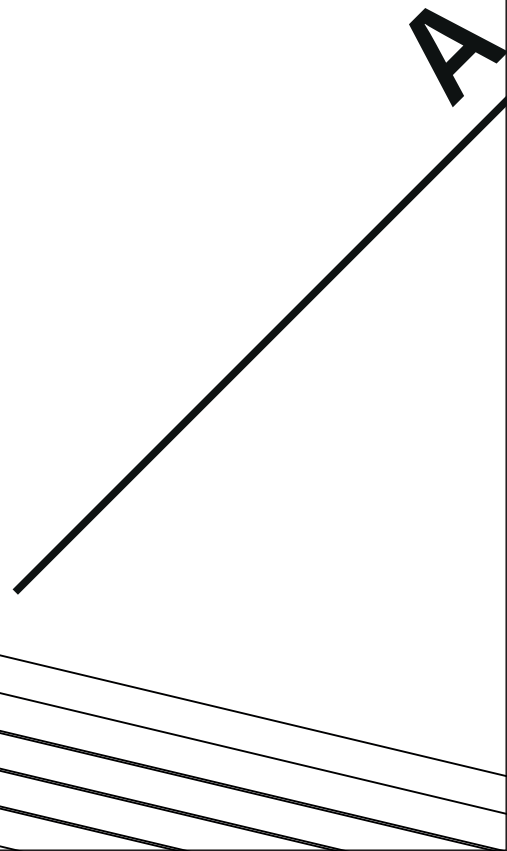
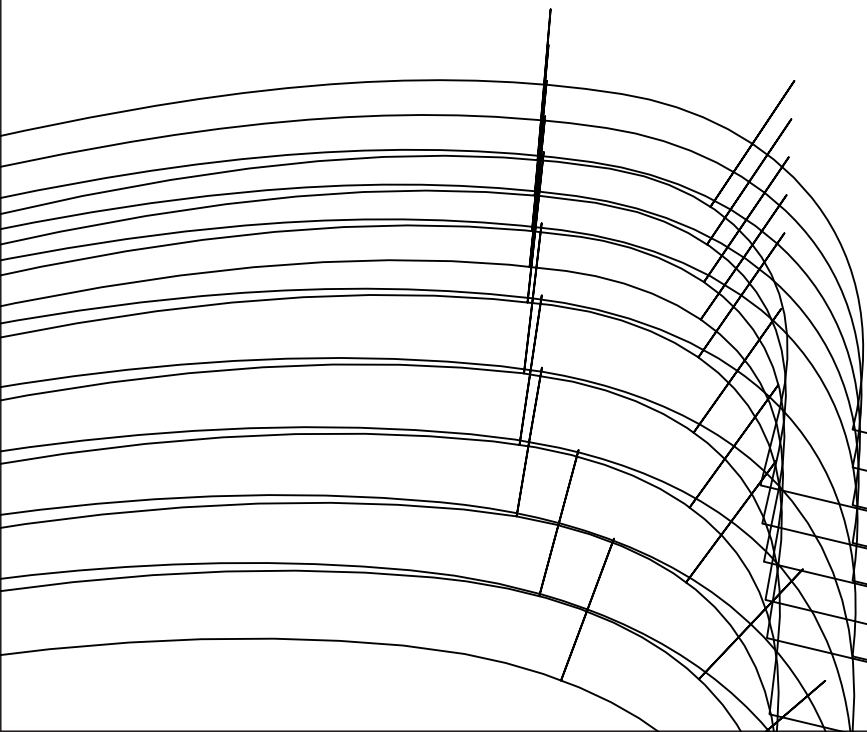
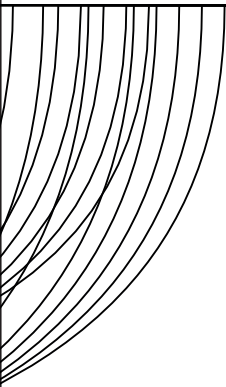

4

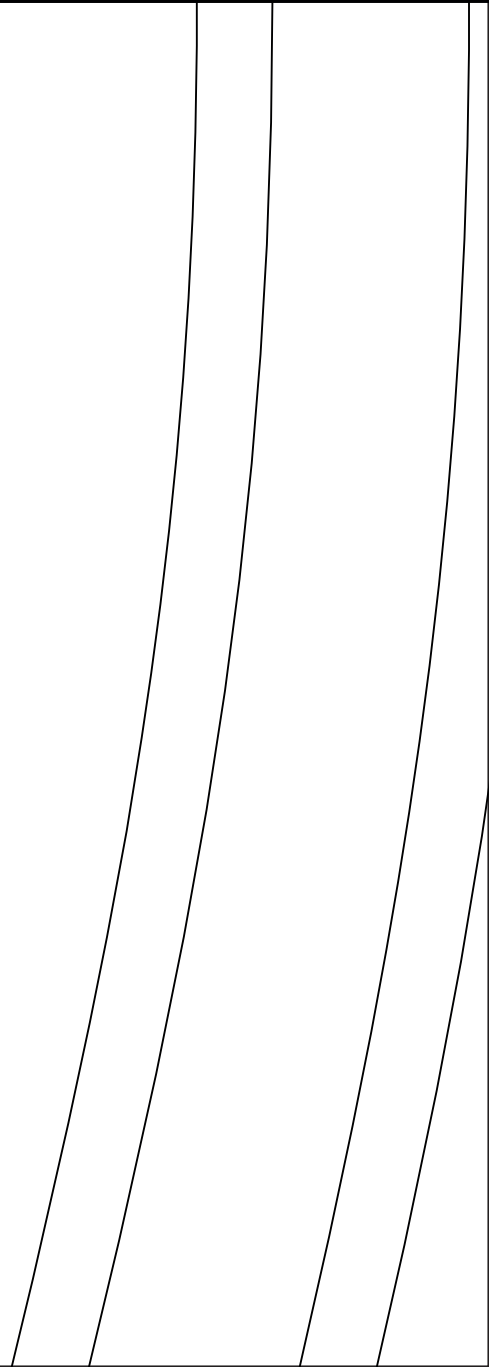
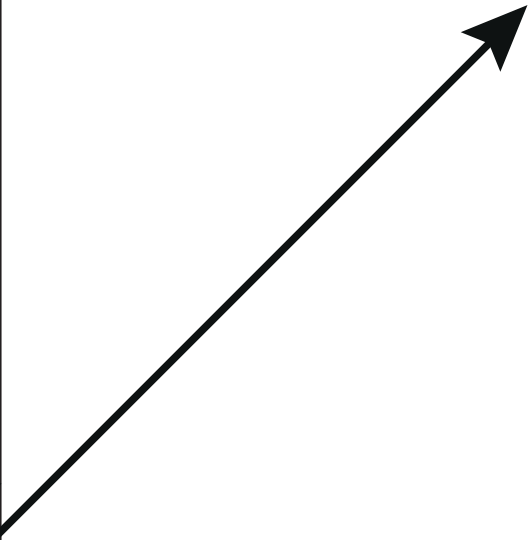

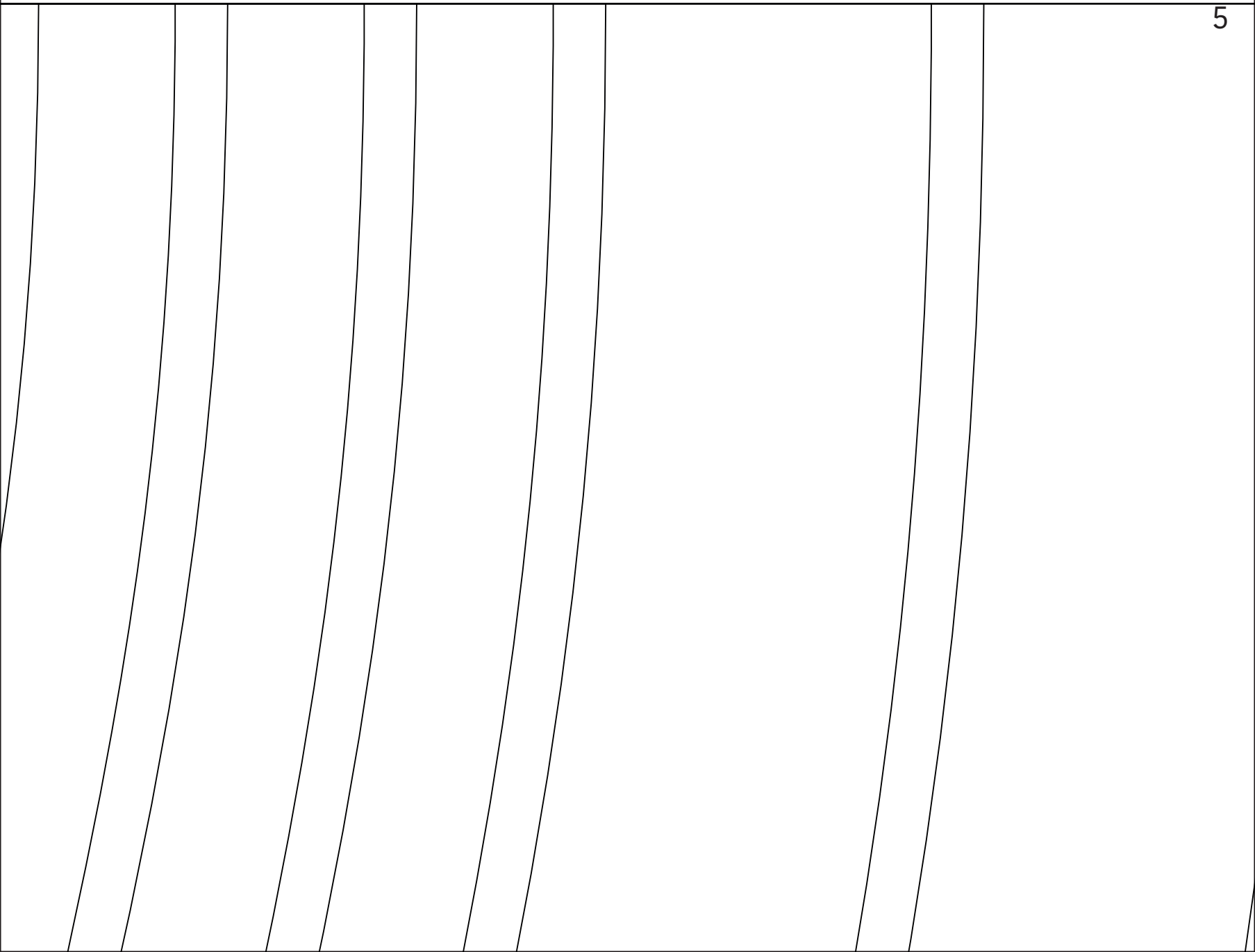

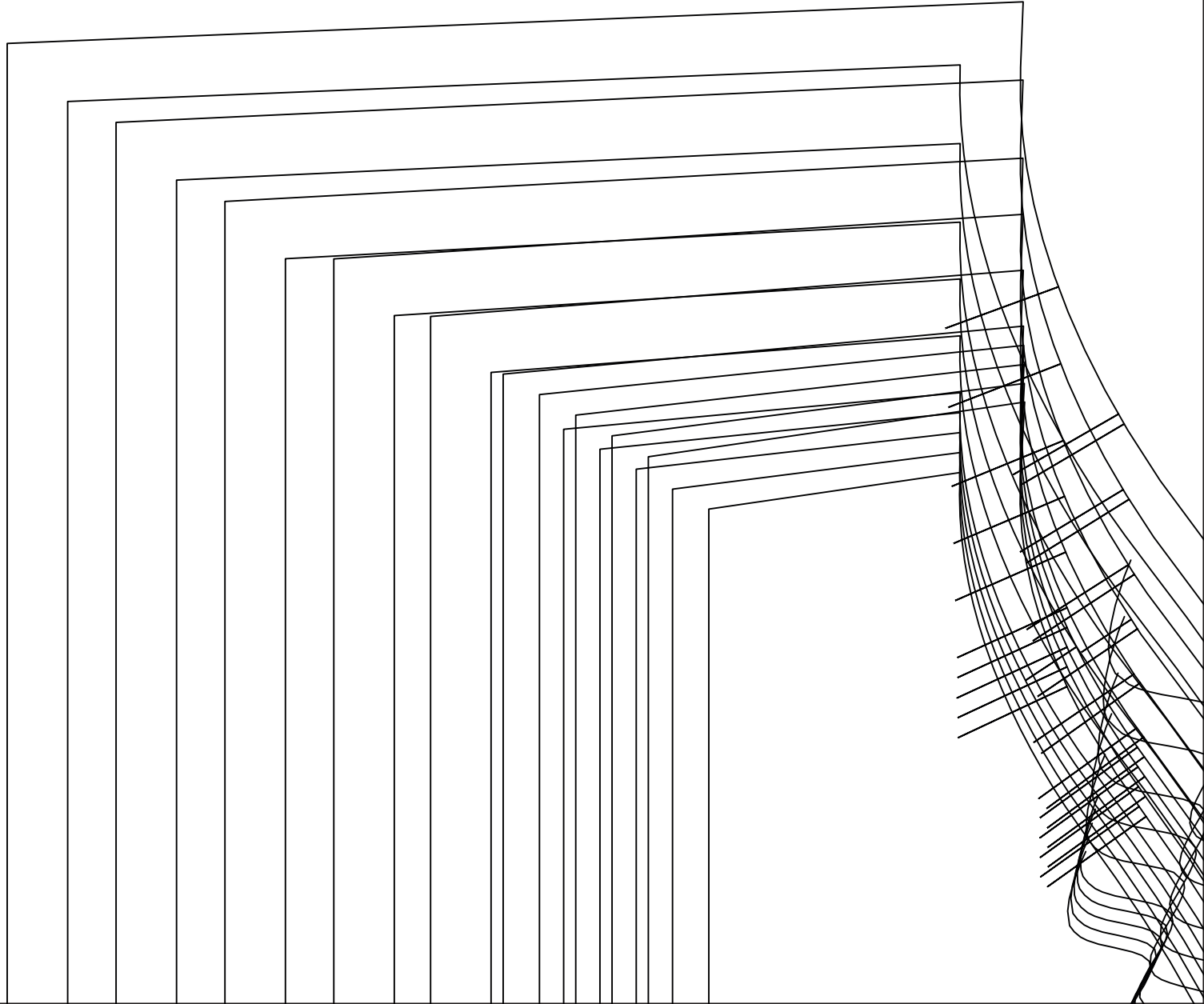

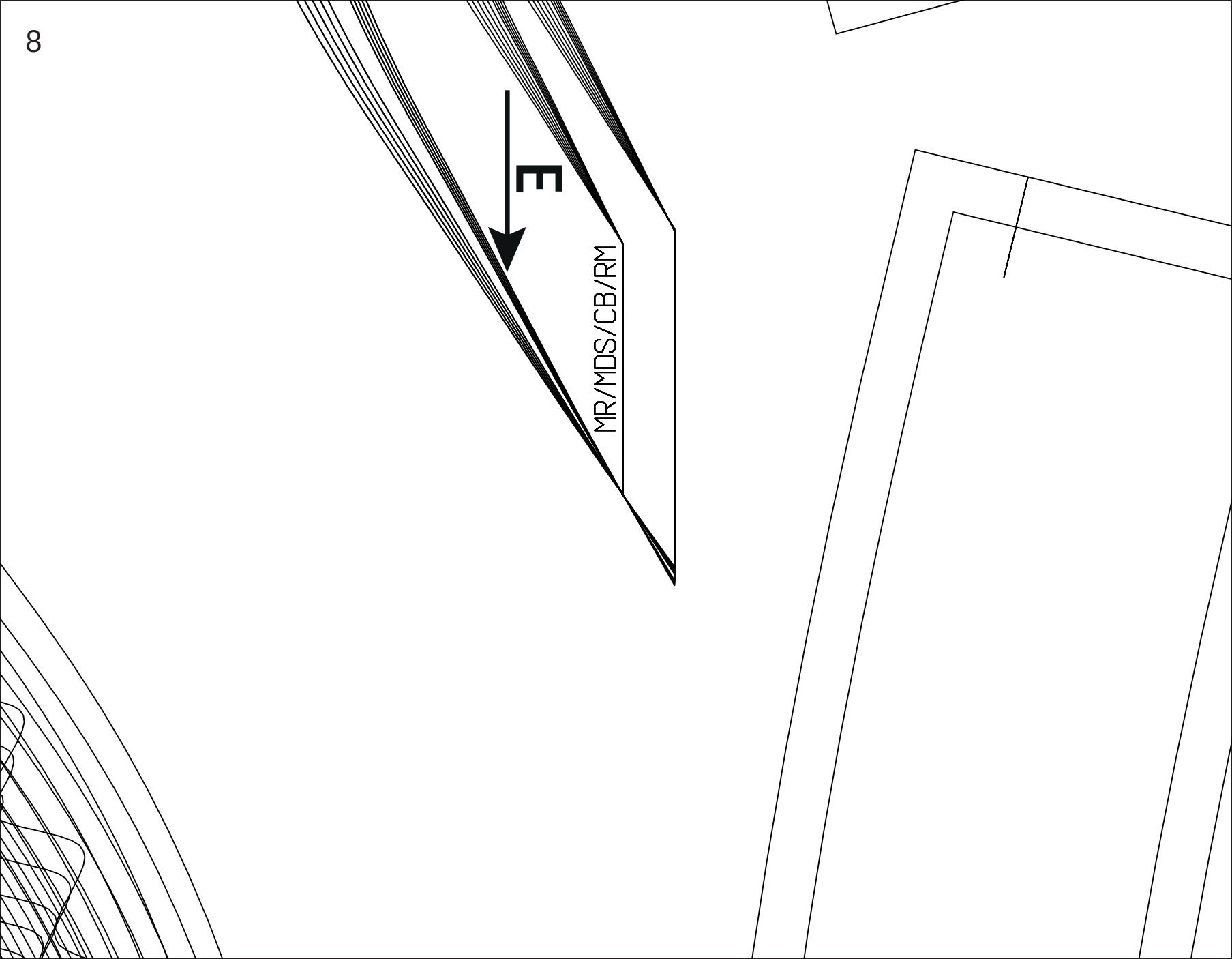

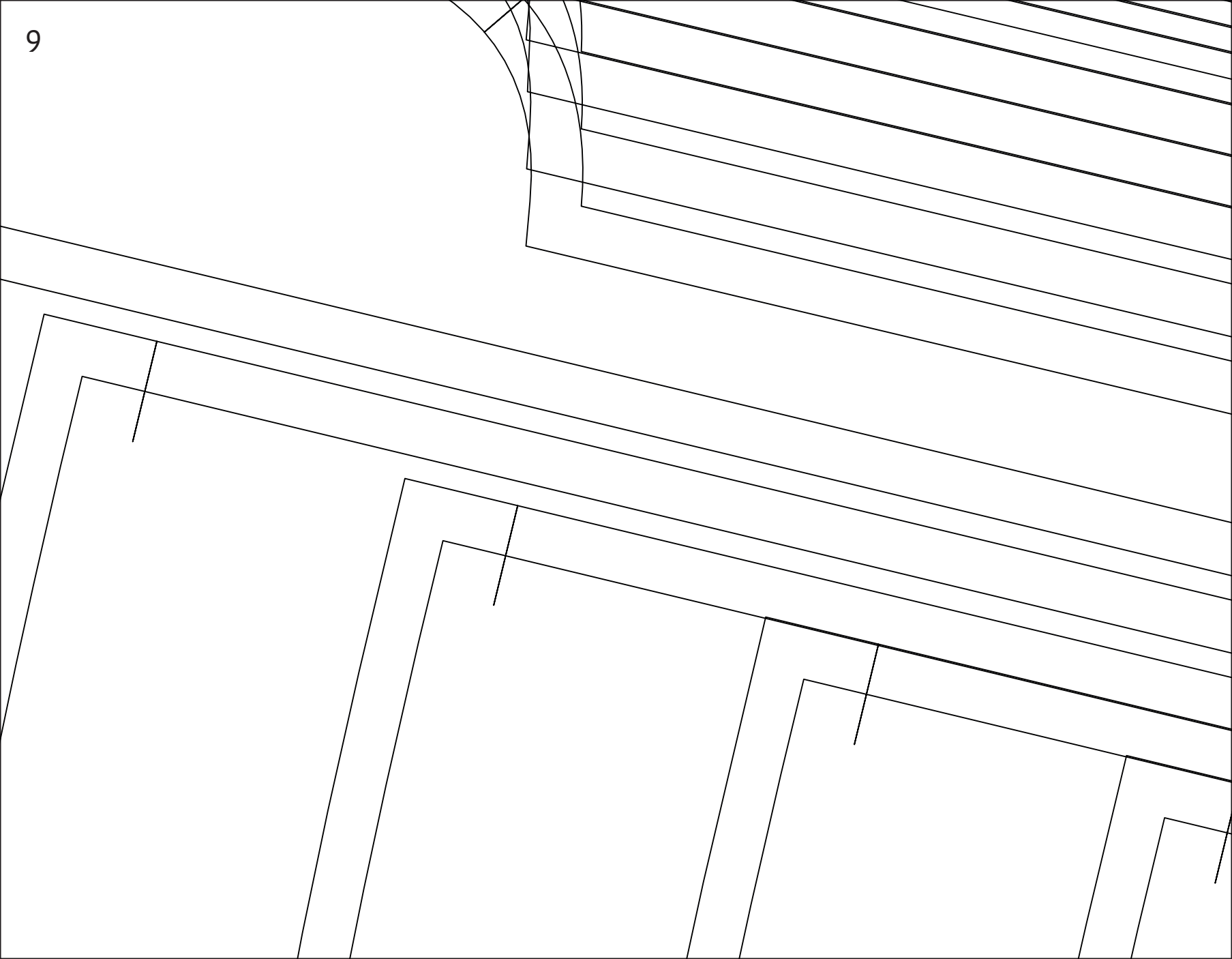

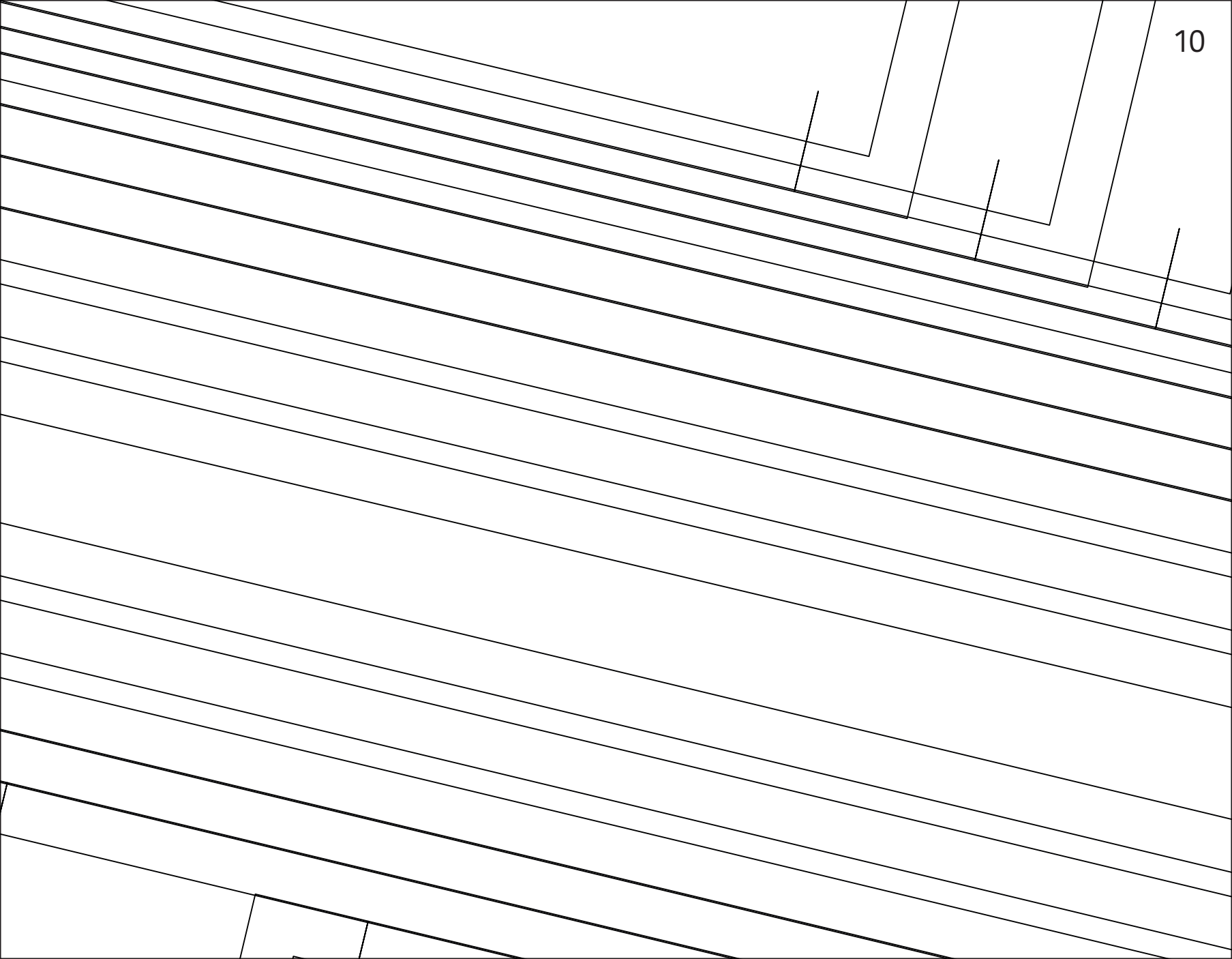

11

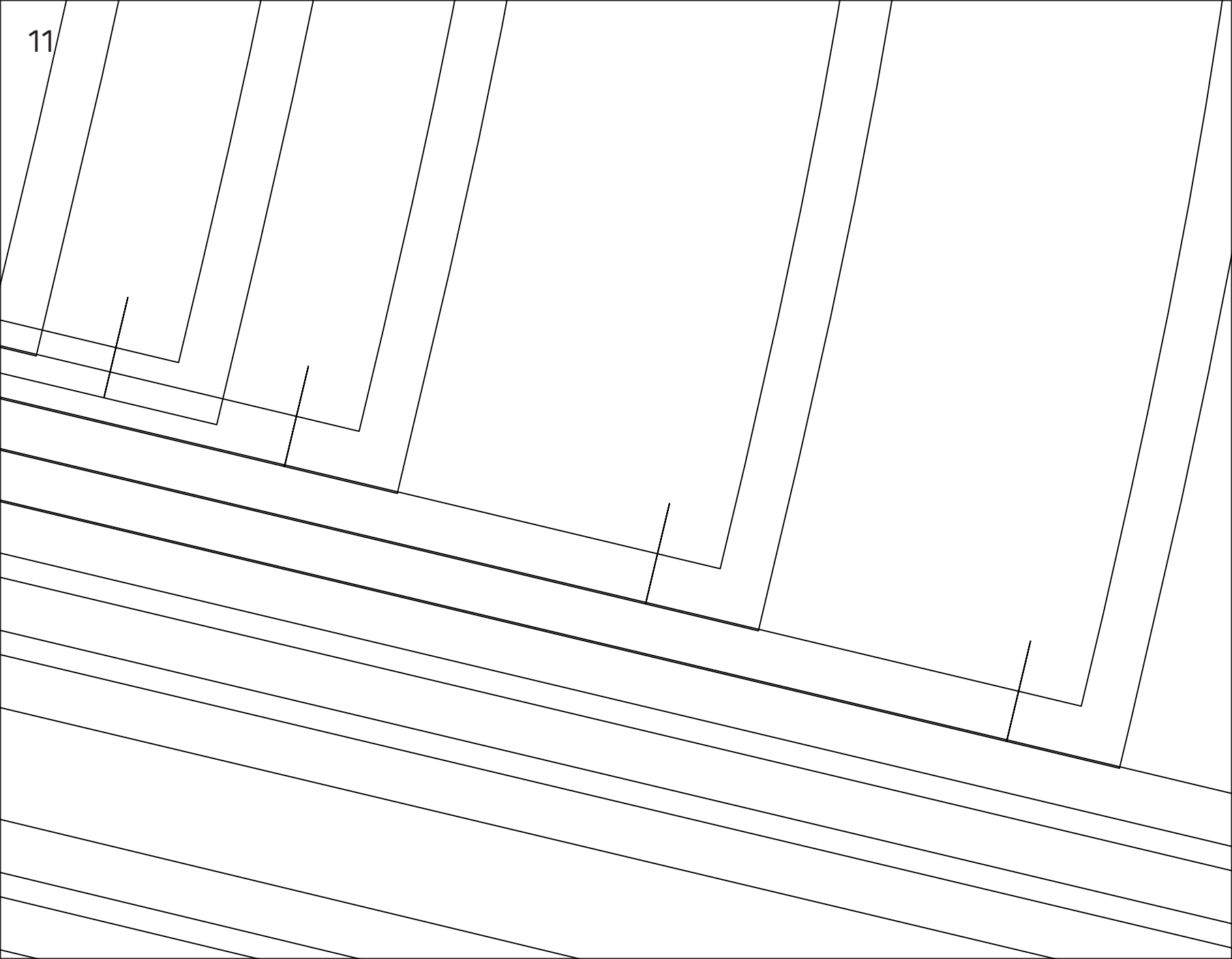

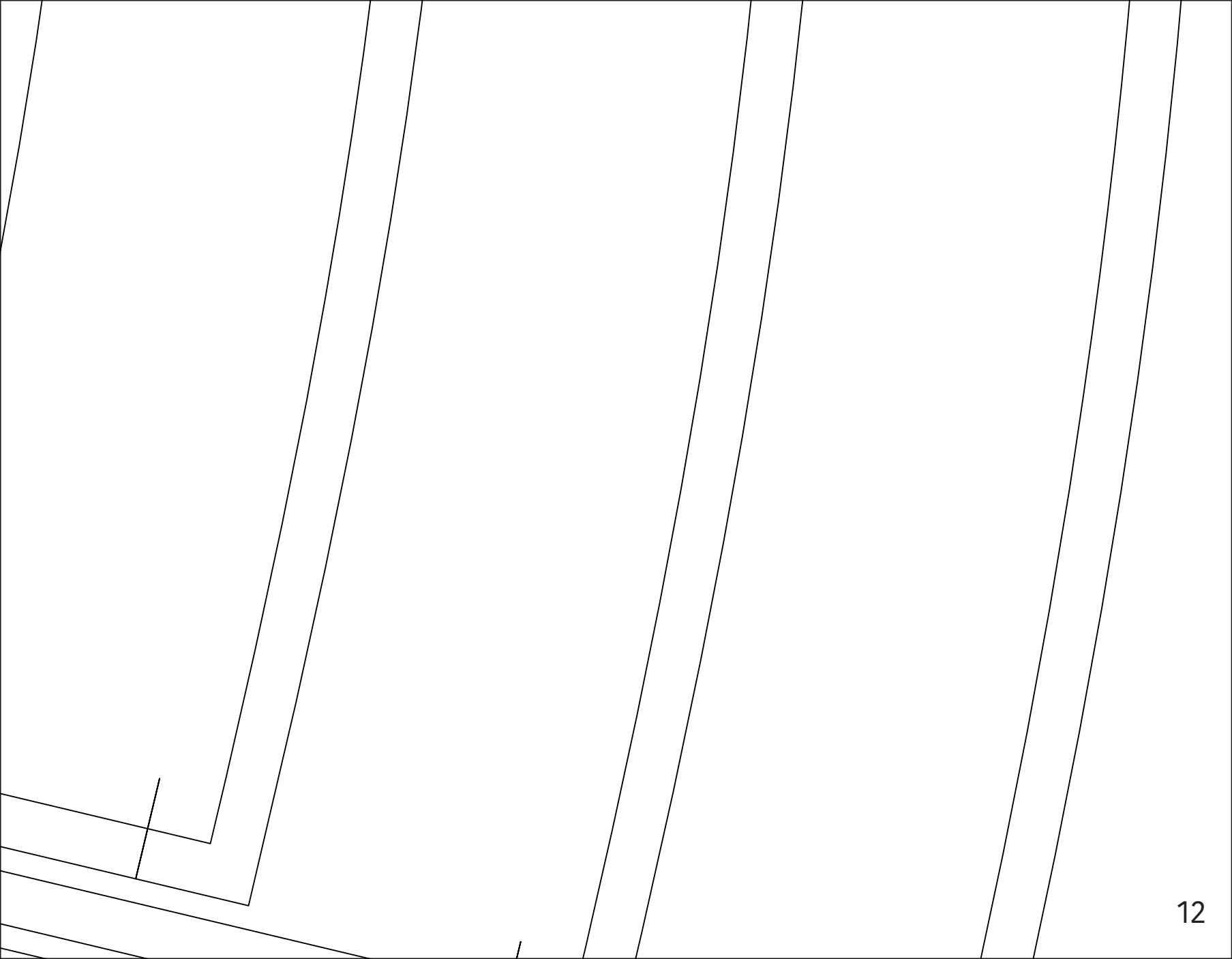



--	--	--	--	--	--	--	--	--	--	--	--	--	--	--	--	--	--	--	--	--	--	--	--

←)

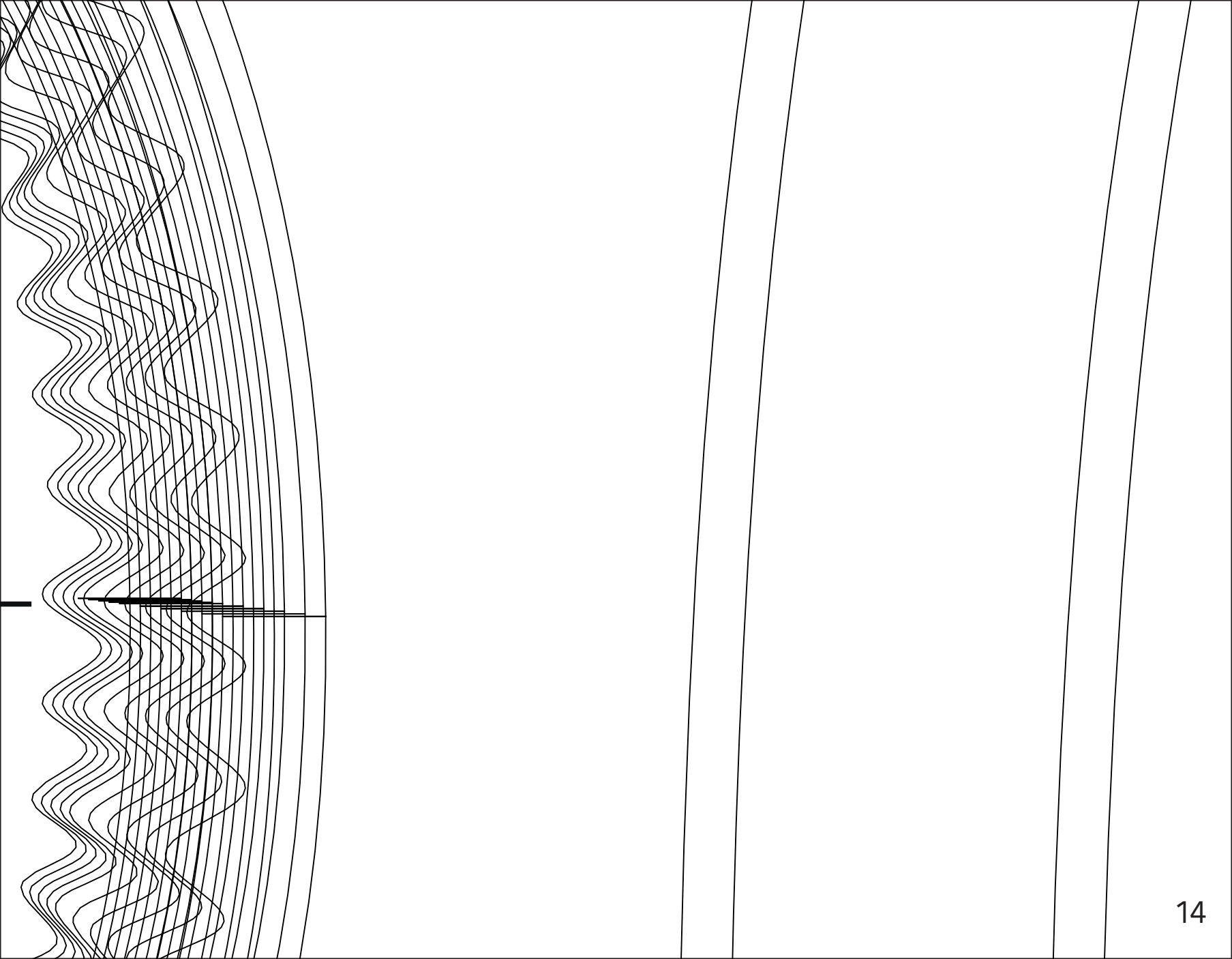

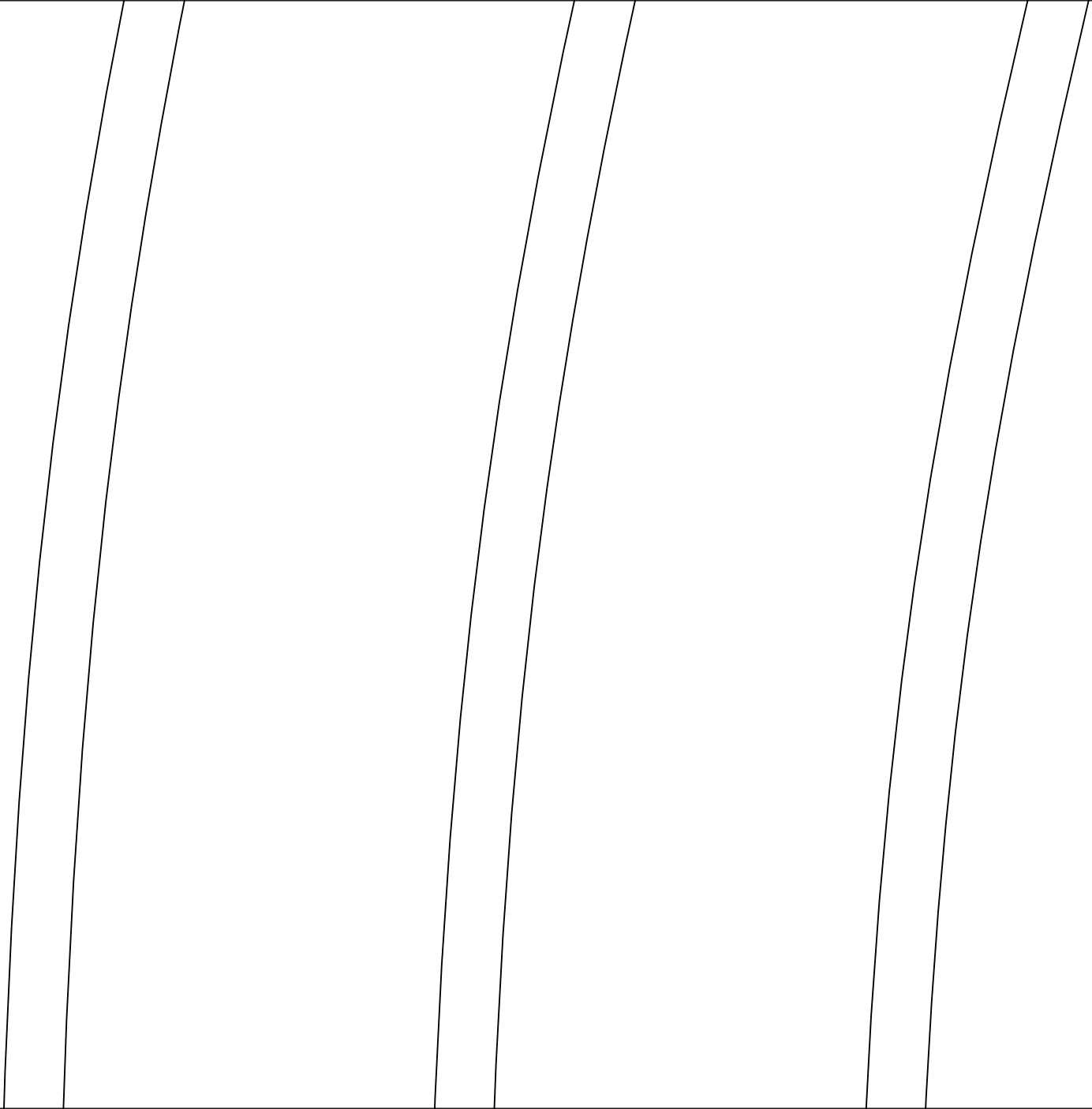

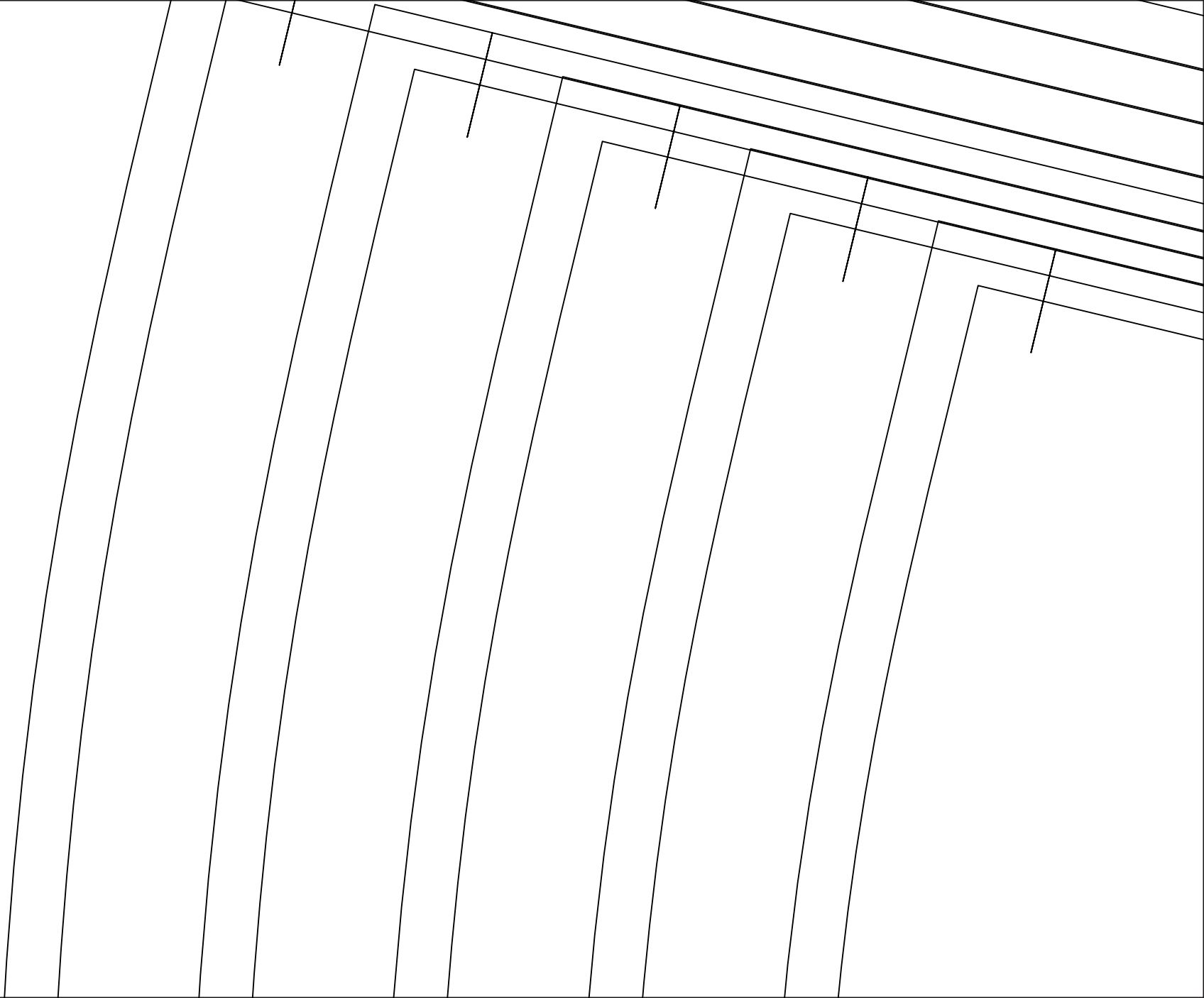

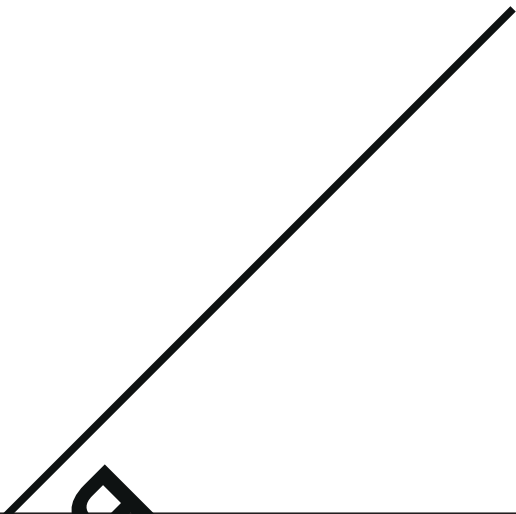
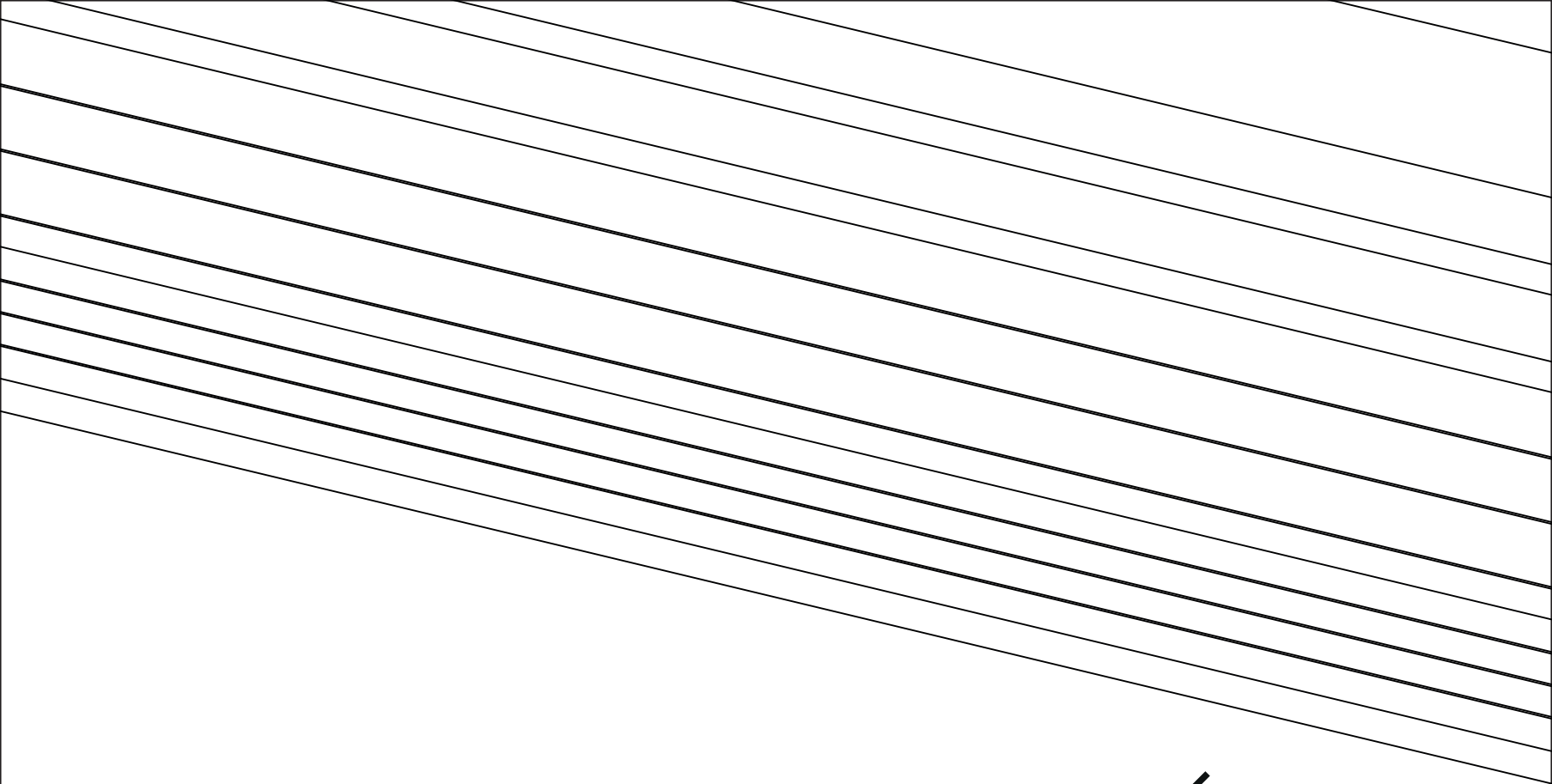

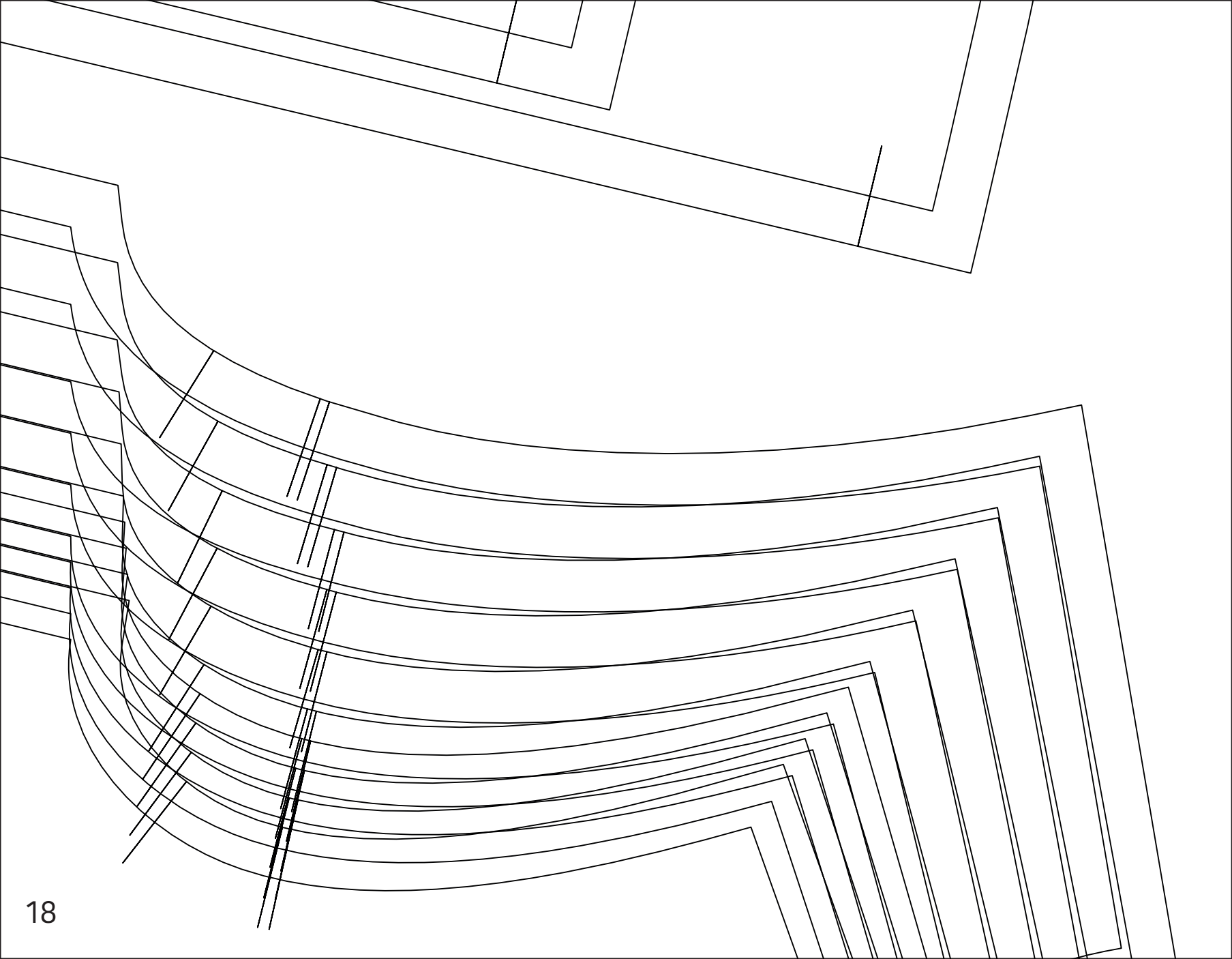

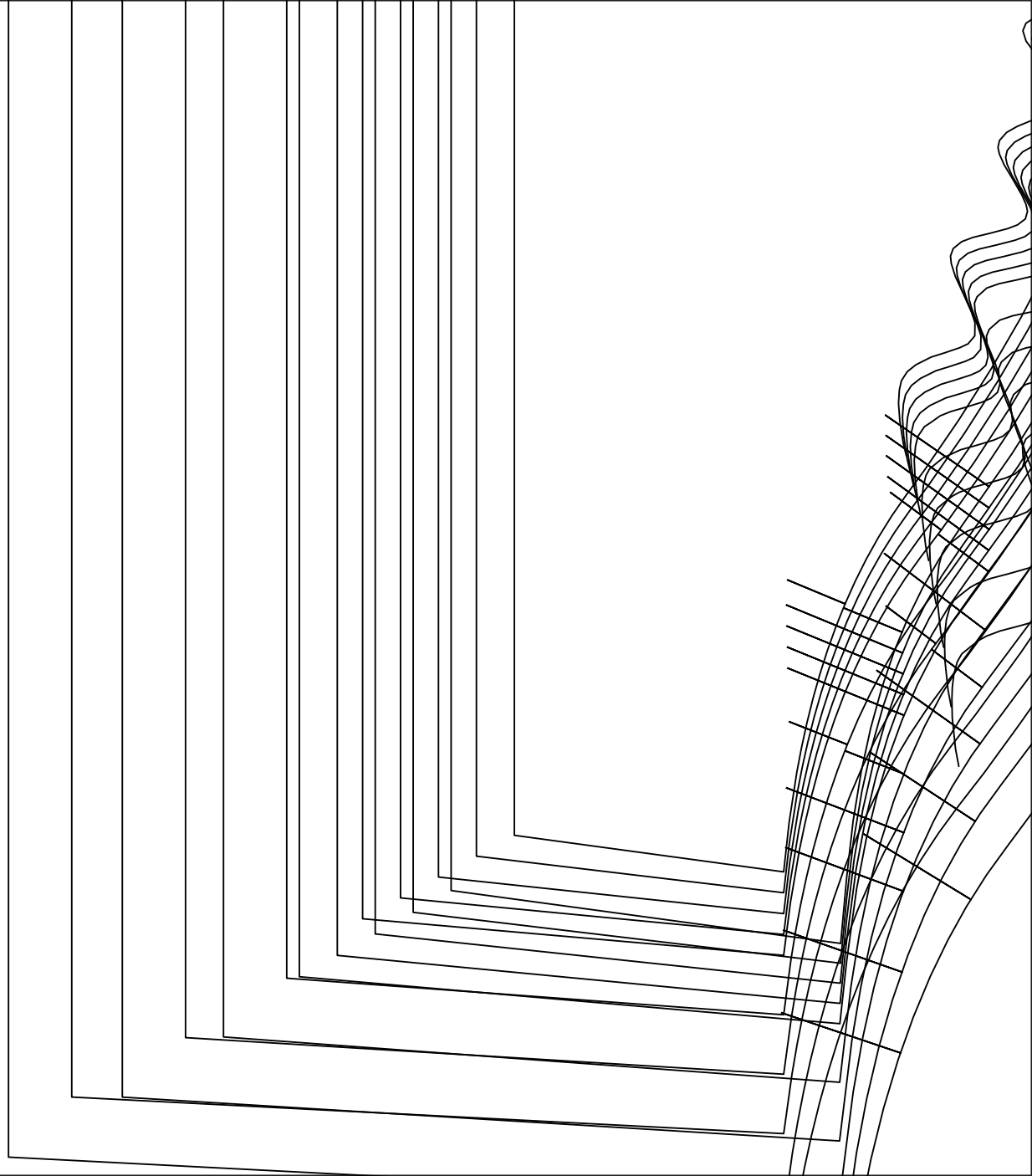

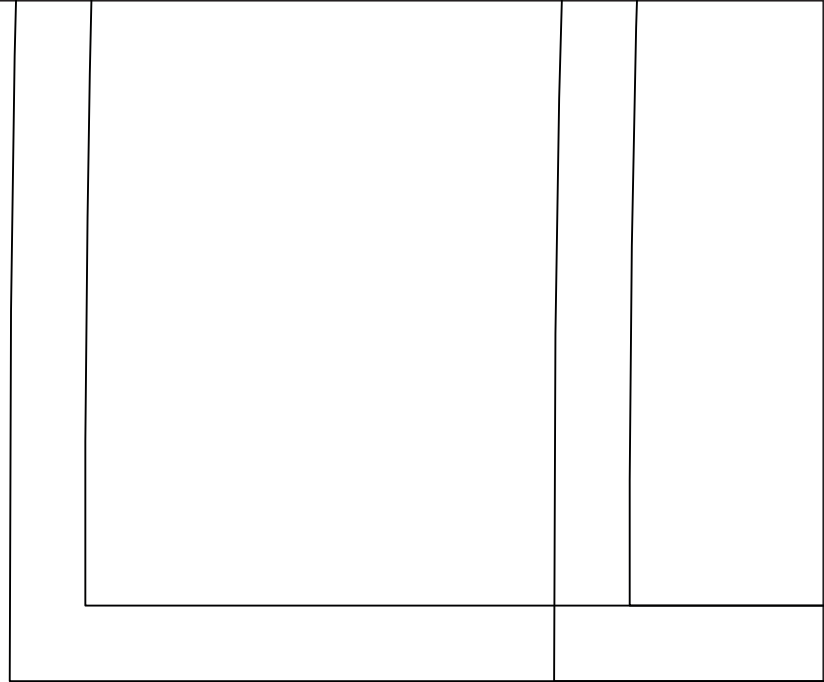
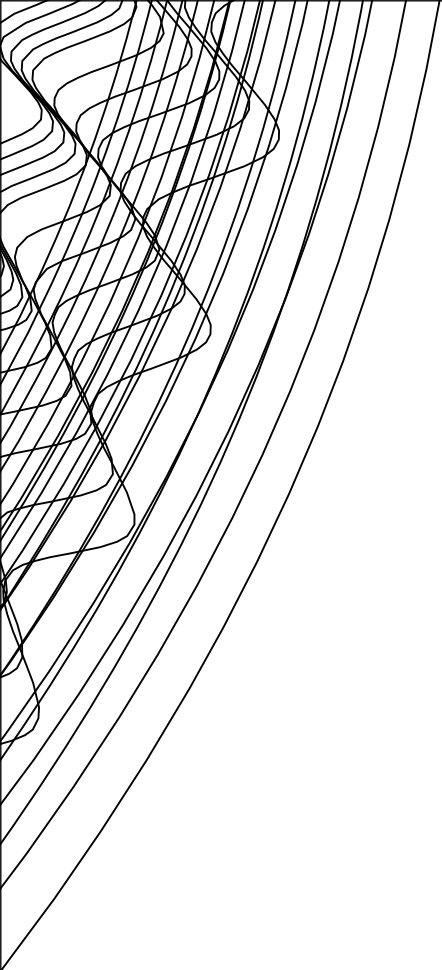

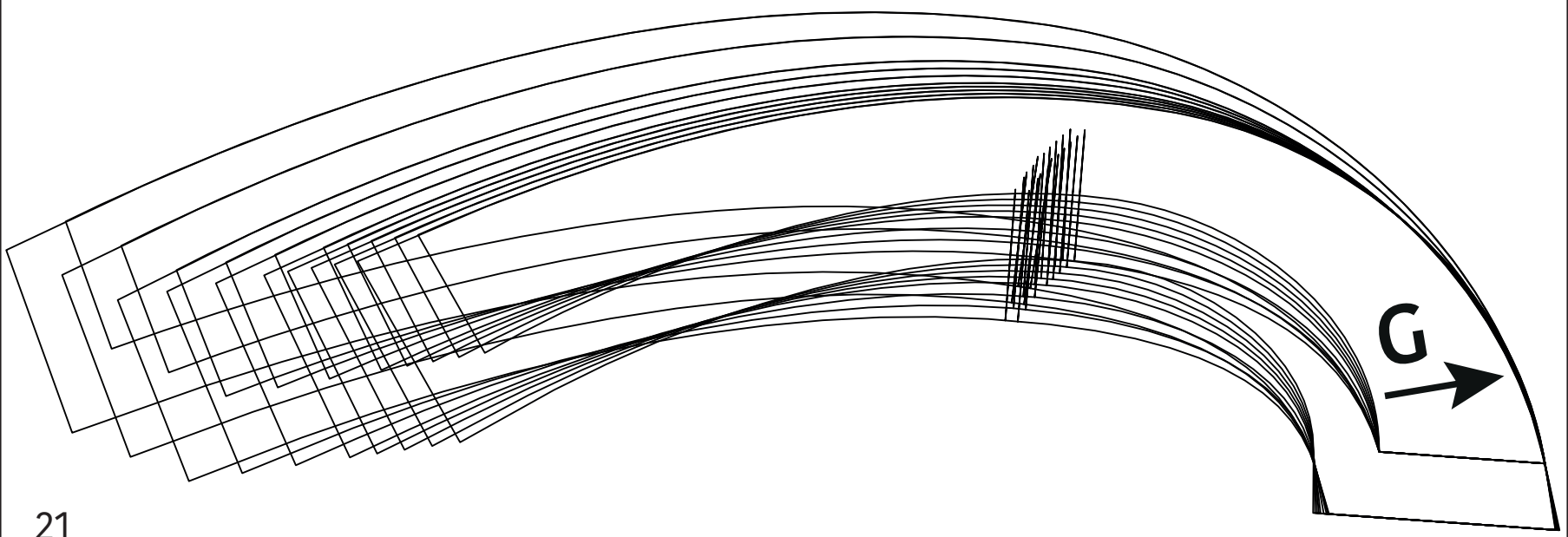

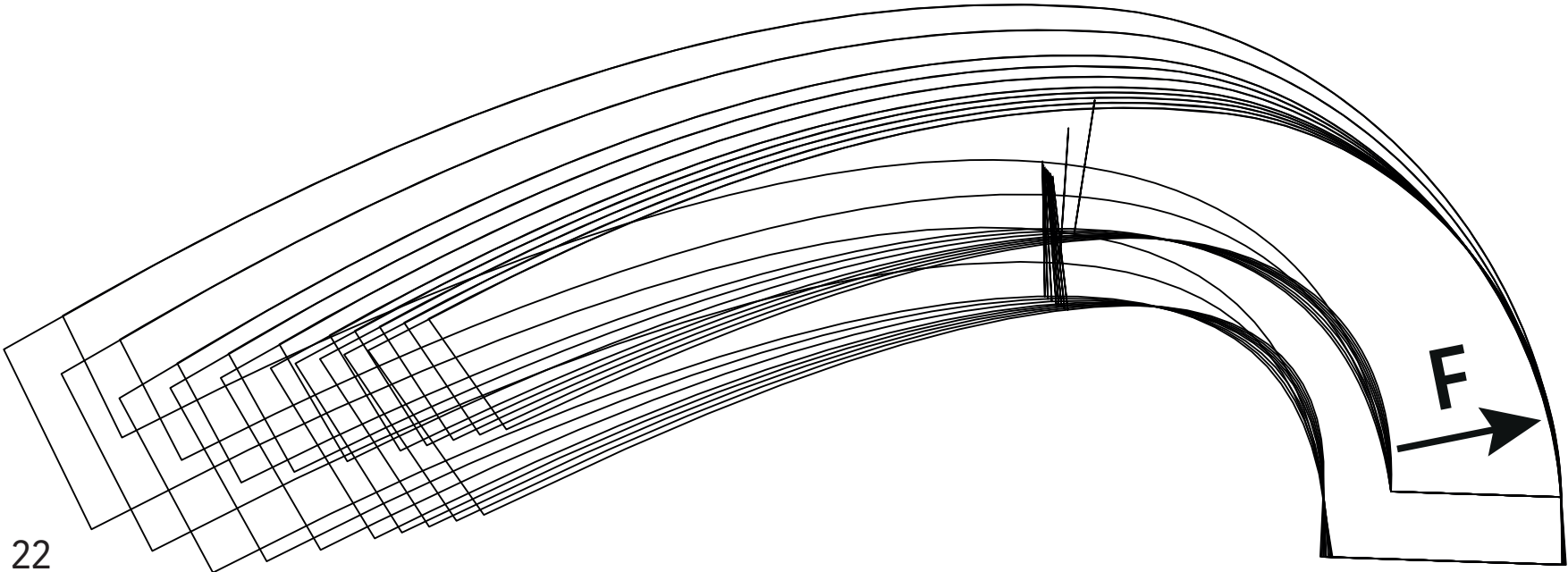
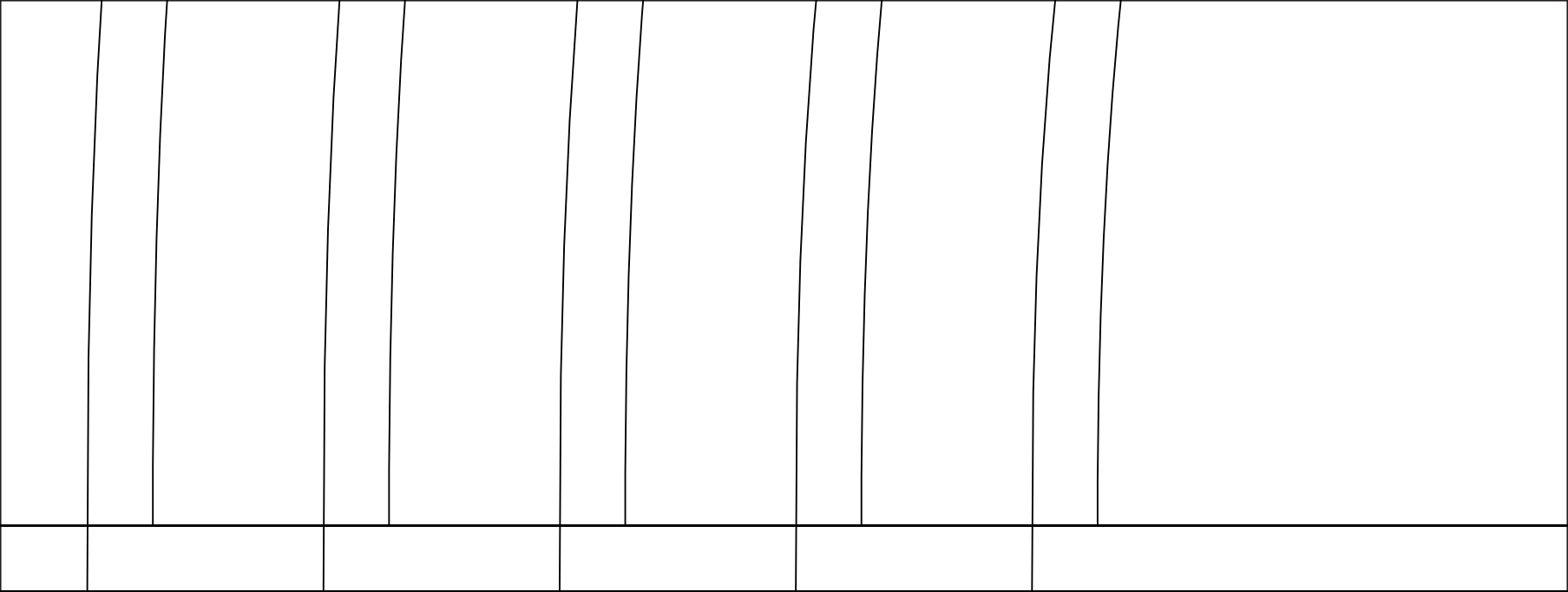

99

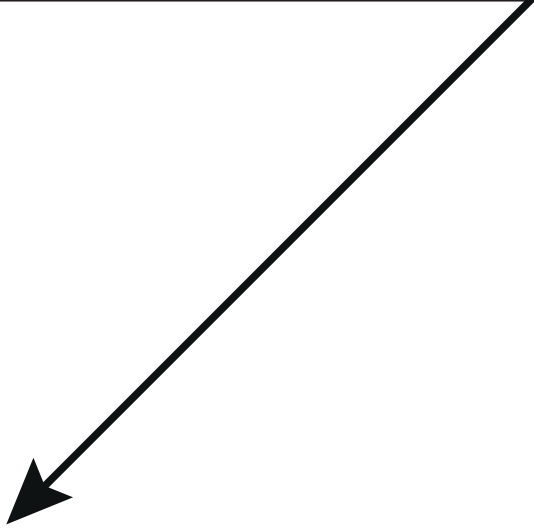

MR/MDS/CB/RM

