

# Lana

## Sweater / Sweat-shirt / Jumper / Sweatshirt

### Maten / Tailles / Sizes / Größen:

-----	34
-----	36
-----	38
-----	40
-----	42
-----	44
-----	46
-----	48
-----	50
-----	52
-----	54
-----	56

### Patroondelen / Pièces du patron / Pattern pieces / Schnittteile:

- A** voorpand / devant / front panel /  
Vorderteil
- B** rugpand / dos / back panel /  
Rückenteil
- C** mouw / manche / sleeve / Ärmel
- D** zoomboord / bord ourlet /  
bottom hem / Saumbund
- E** halsboord / liseré encolure /  
collar / Halsbund
- F** polsboord / bord manchette /  
cuff / Ärmelbündchen

## Patroonschema / Schéma du Patron / Pattern Diagram / Übersichtsplan zum Zusammenkleben

1	2	3	4	5	6
7	8	9	10	11	12
13	14	15	16	17	18
19	20	21	22	23	24
25	X 26	X 27	28	29	30
31					

### Controlevierkant / Carré de controle / Test square / Kontrollquadrat

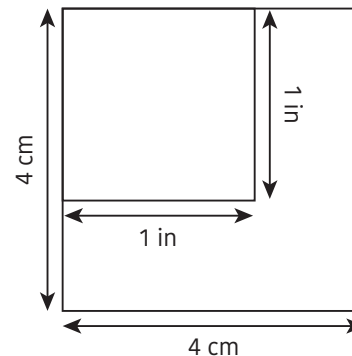

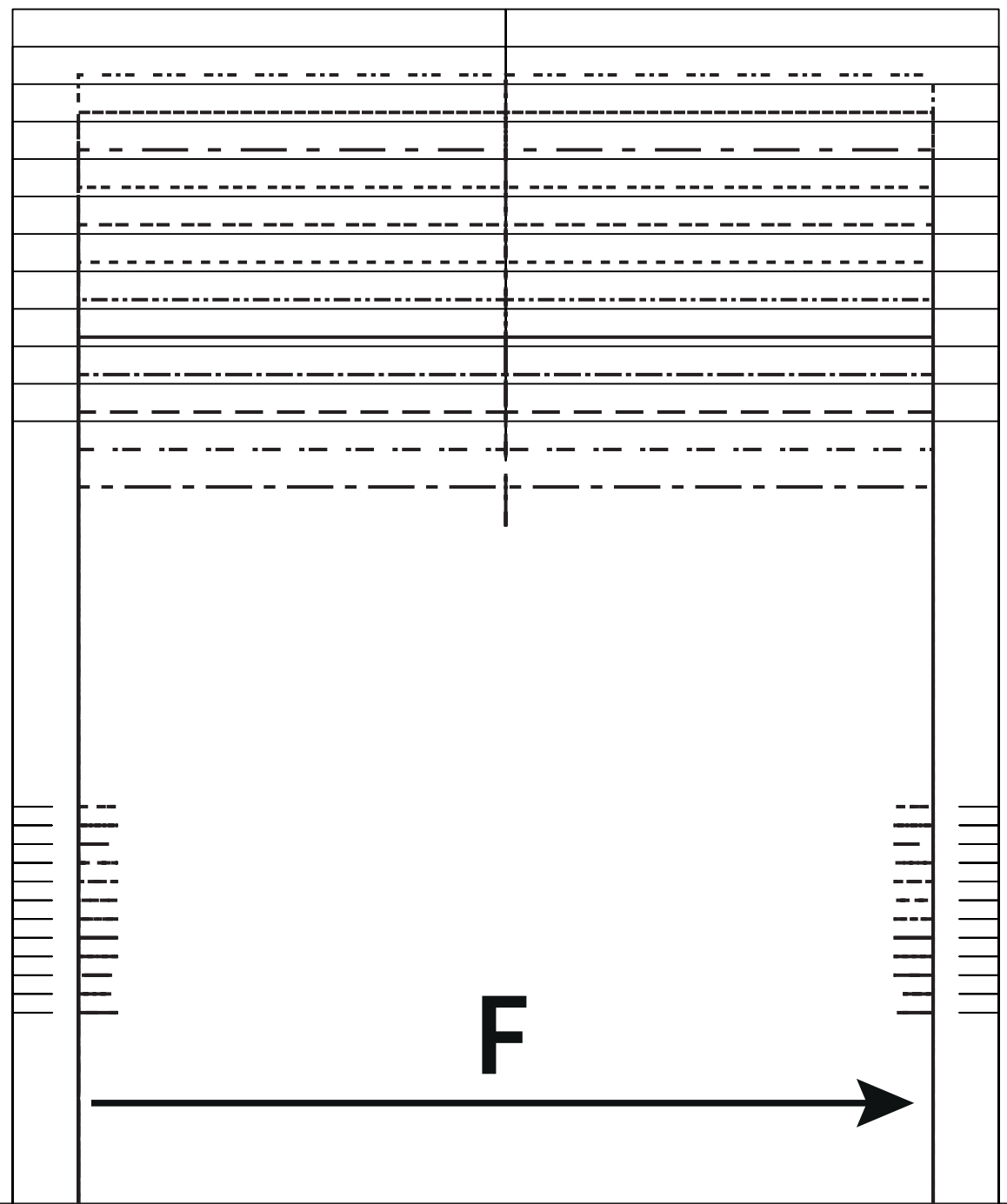

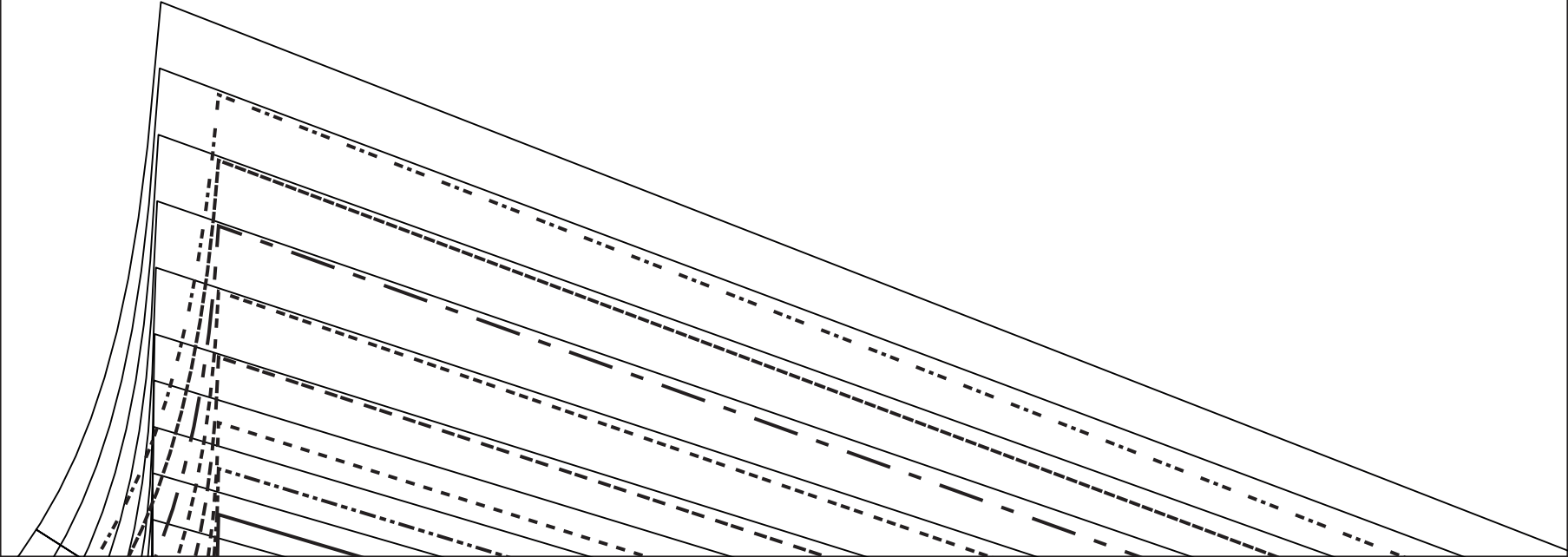

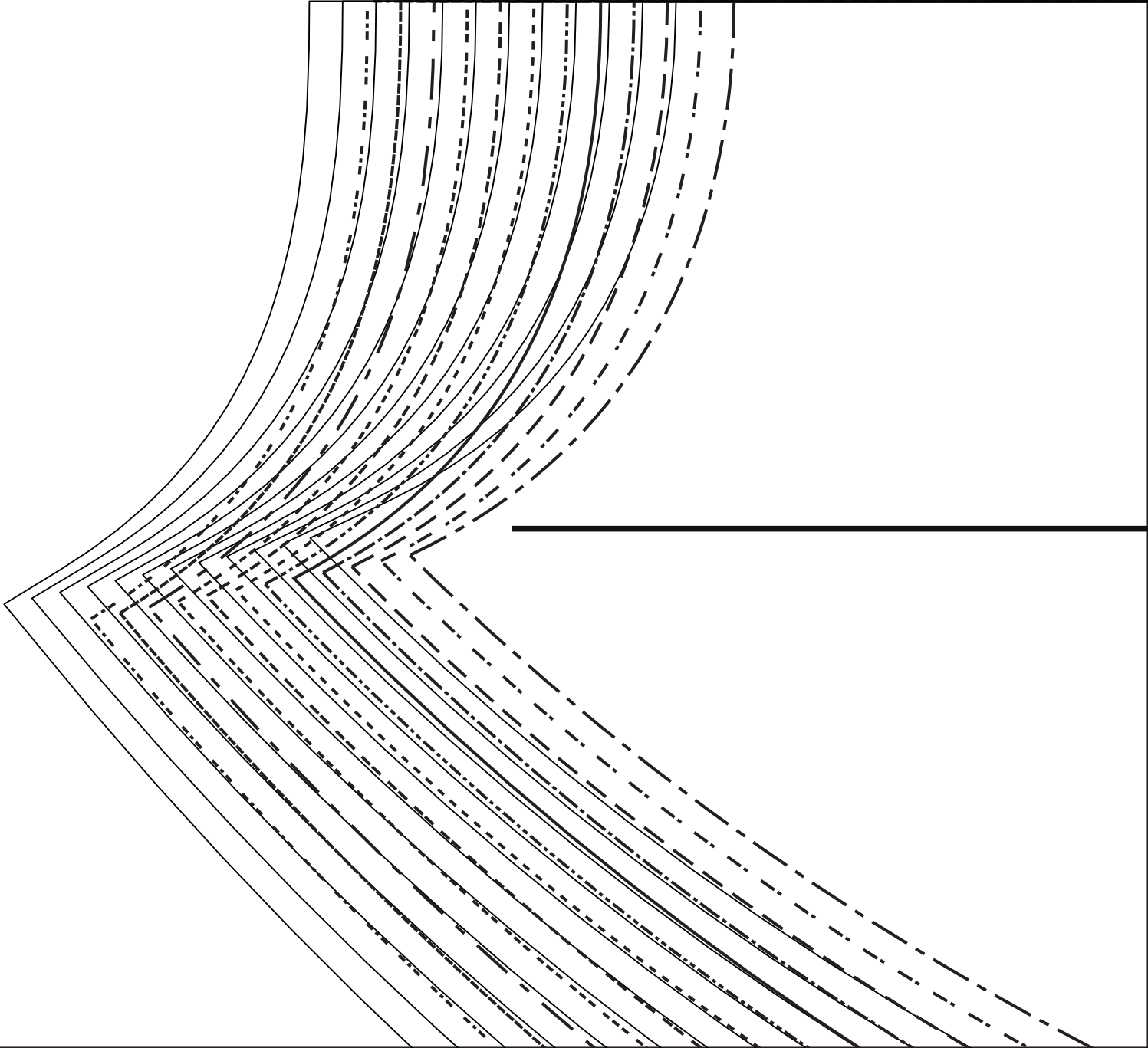

MV/MDV/CF/YM



**A**

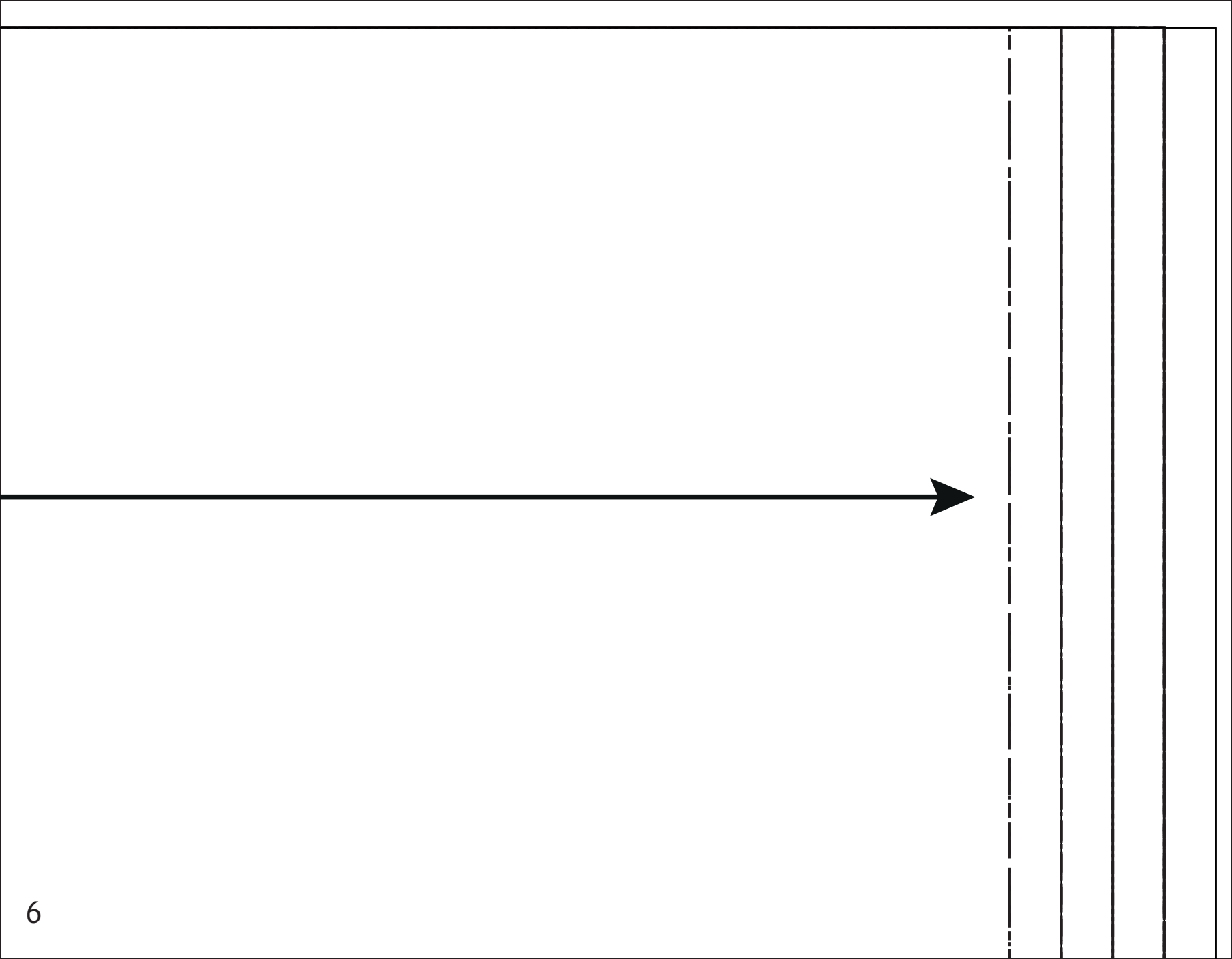



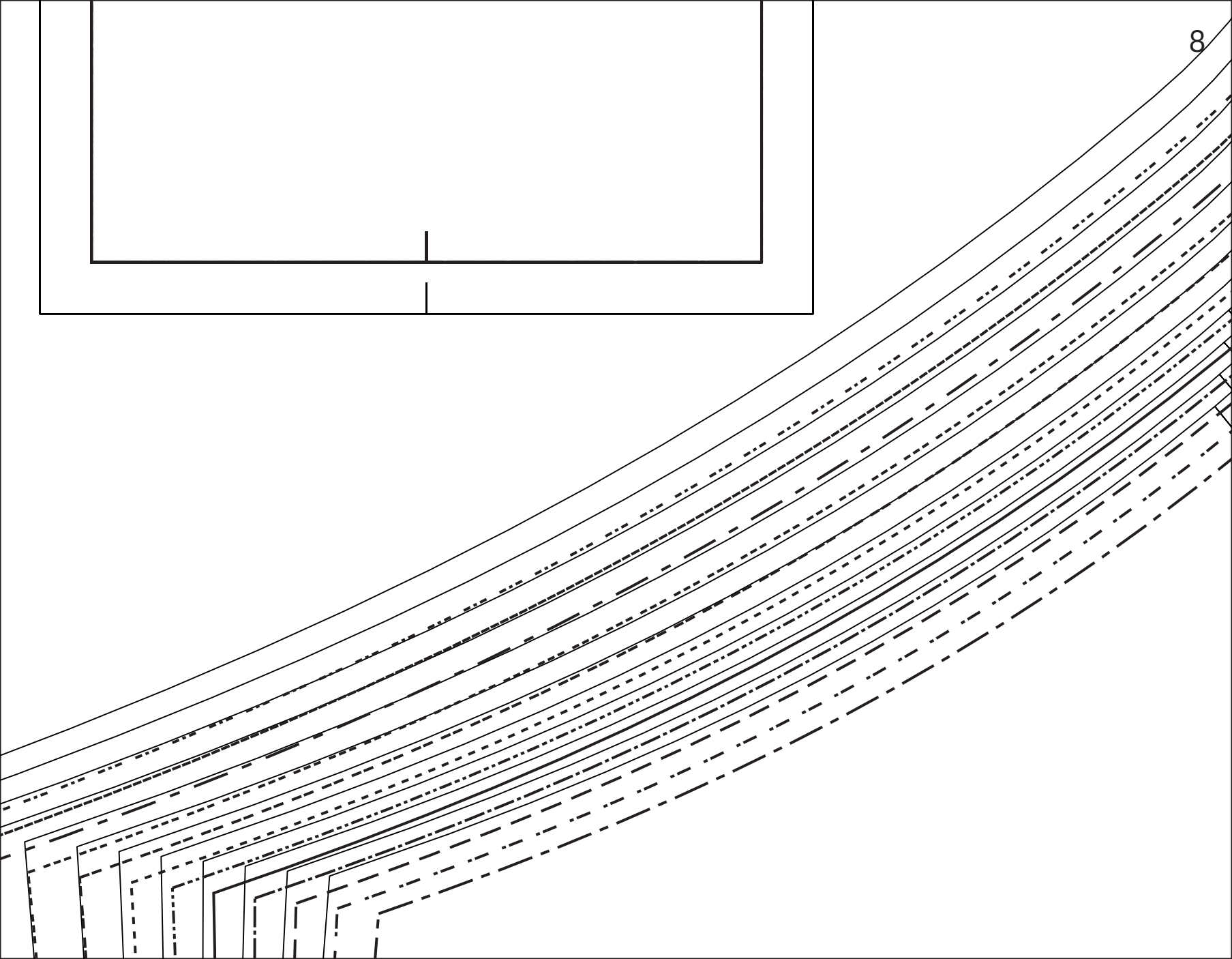



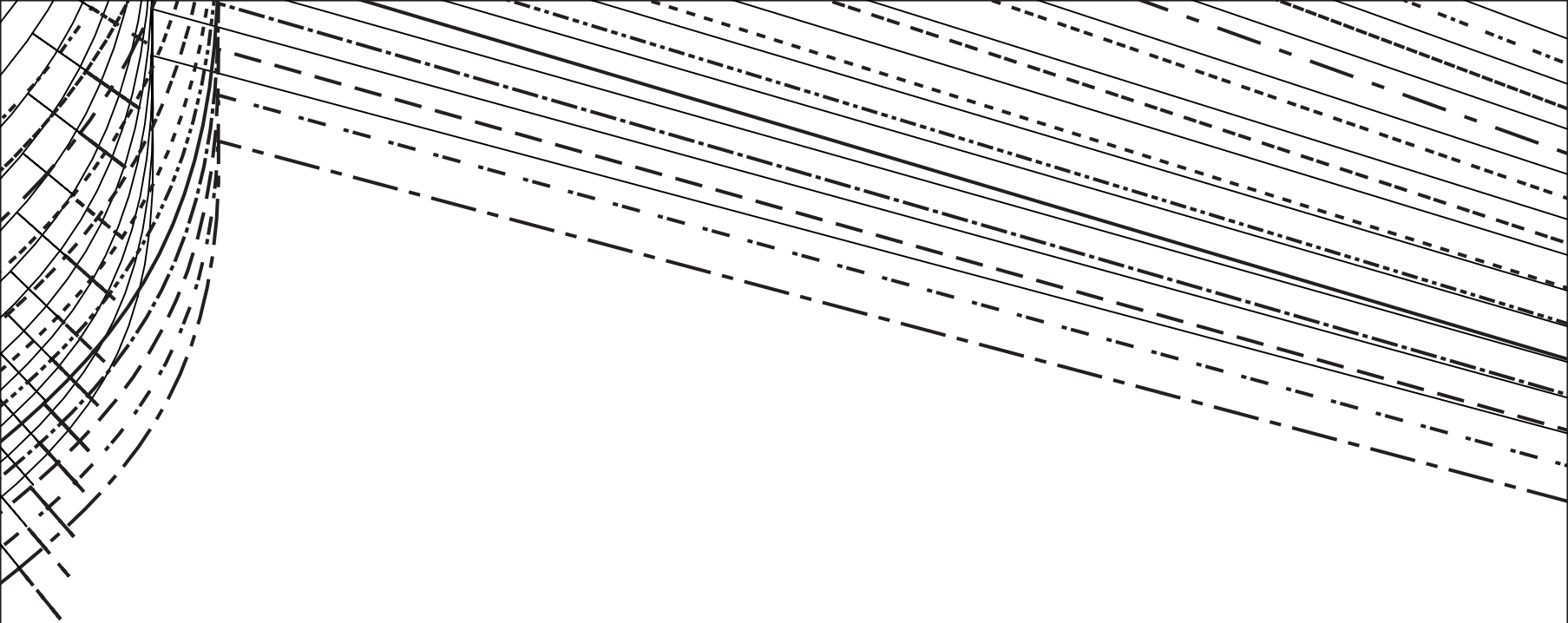

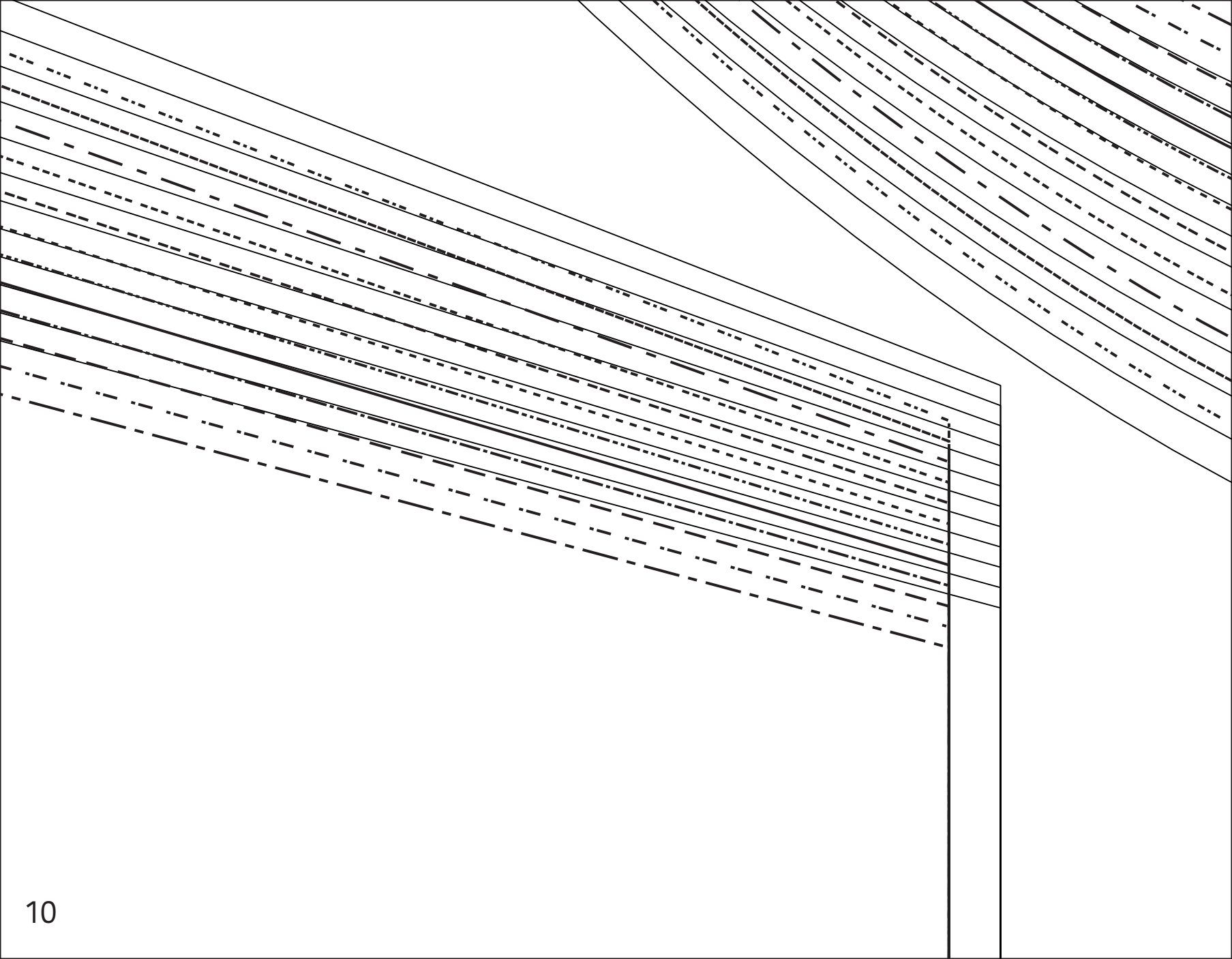

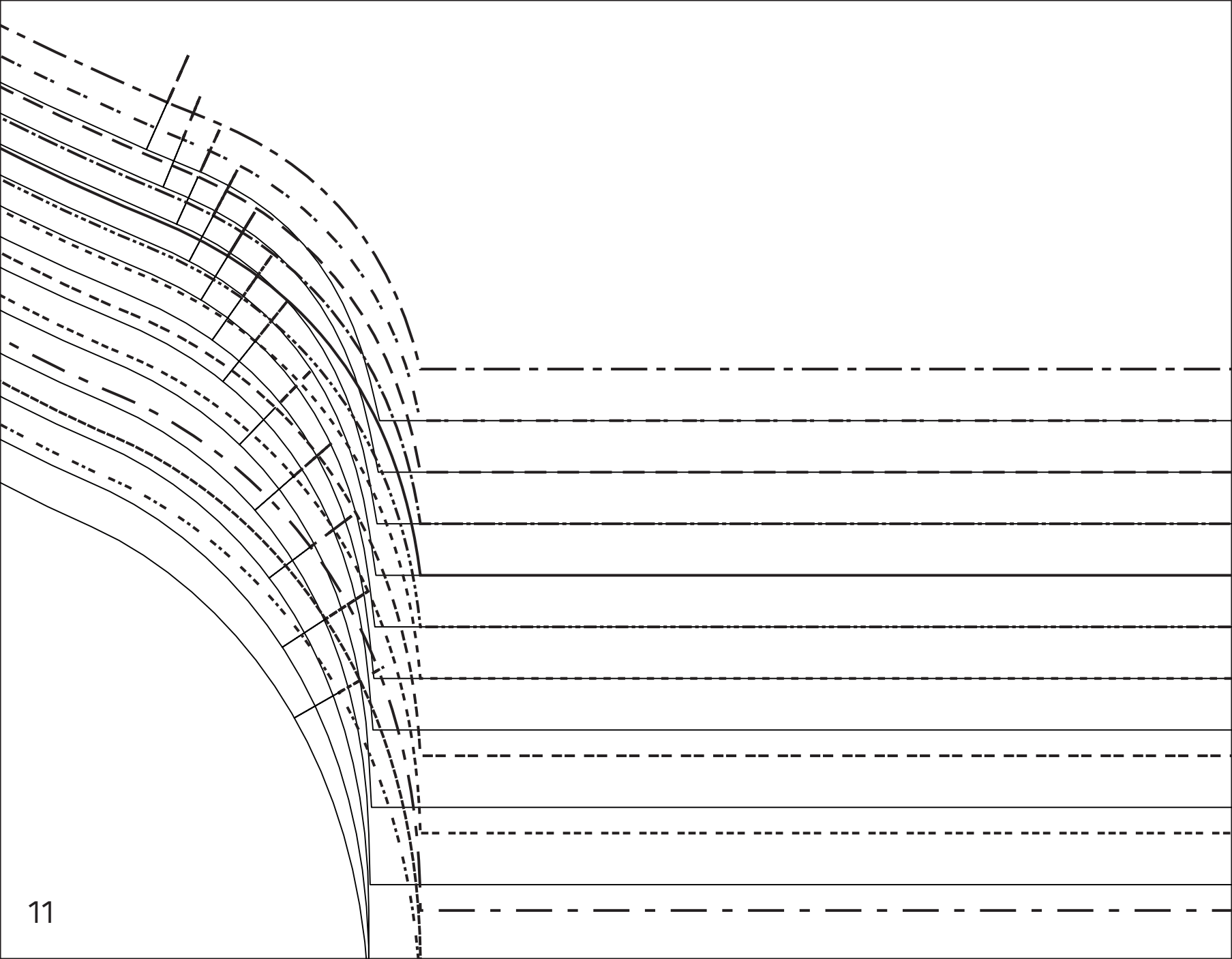



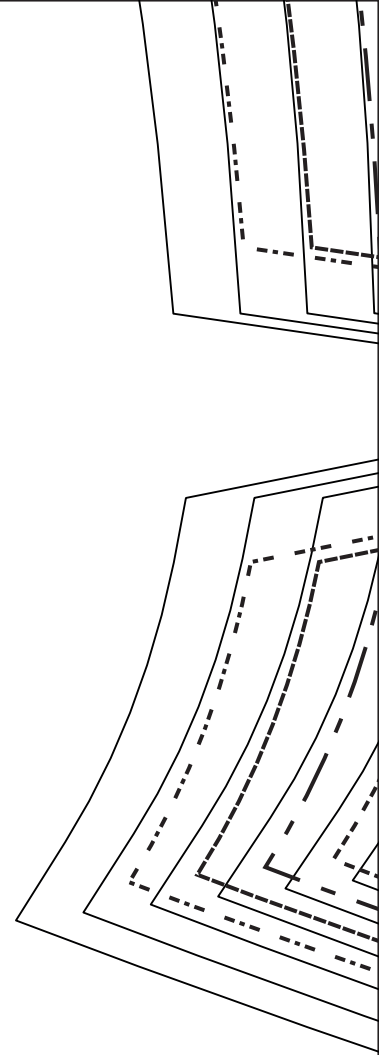

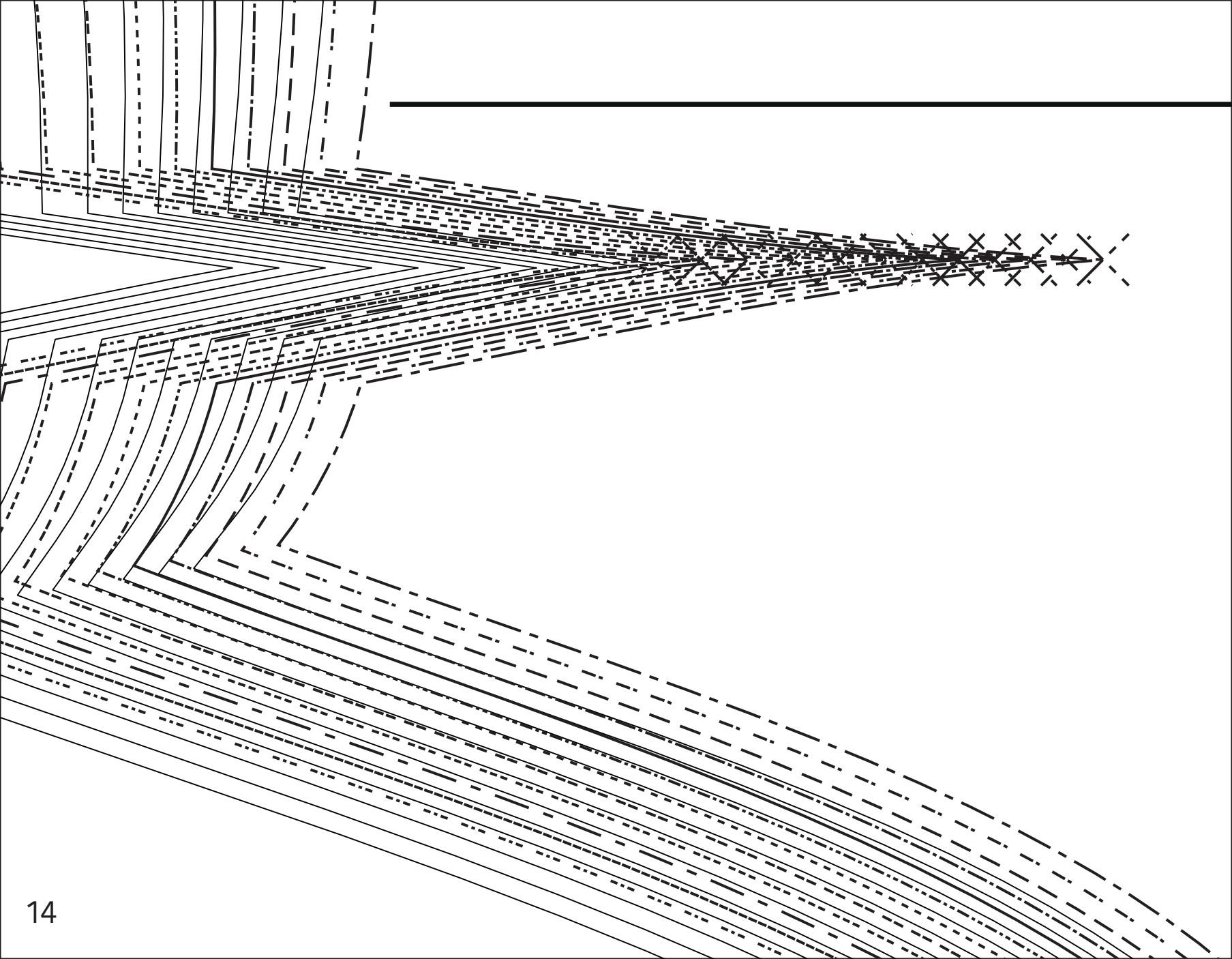



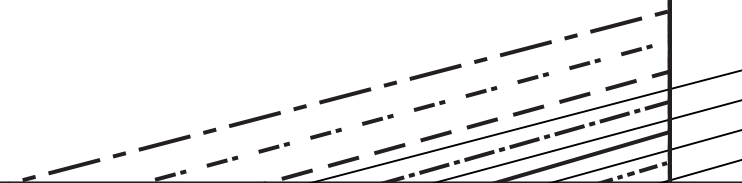
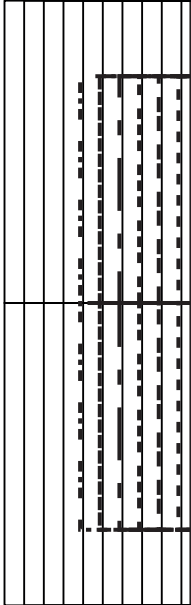



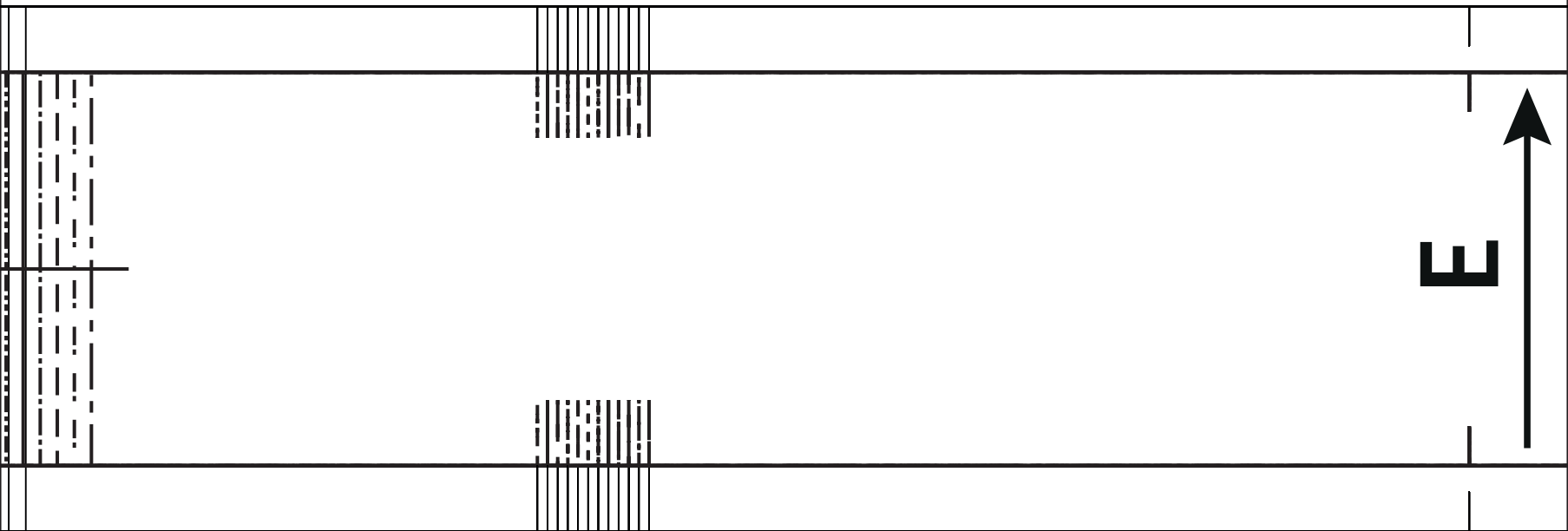
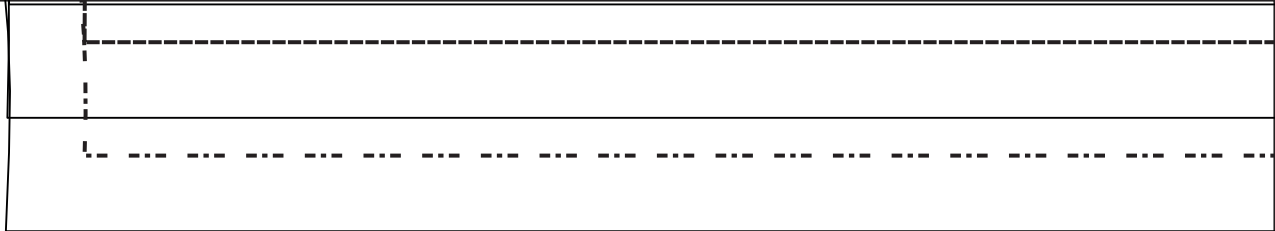

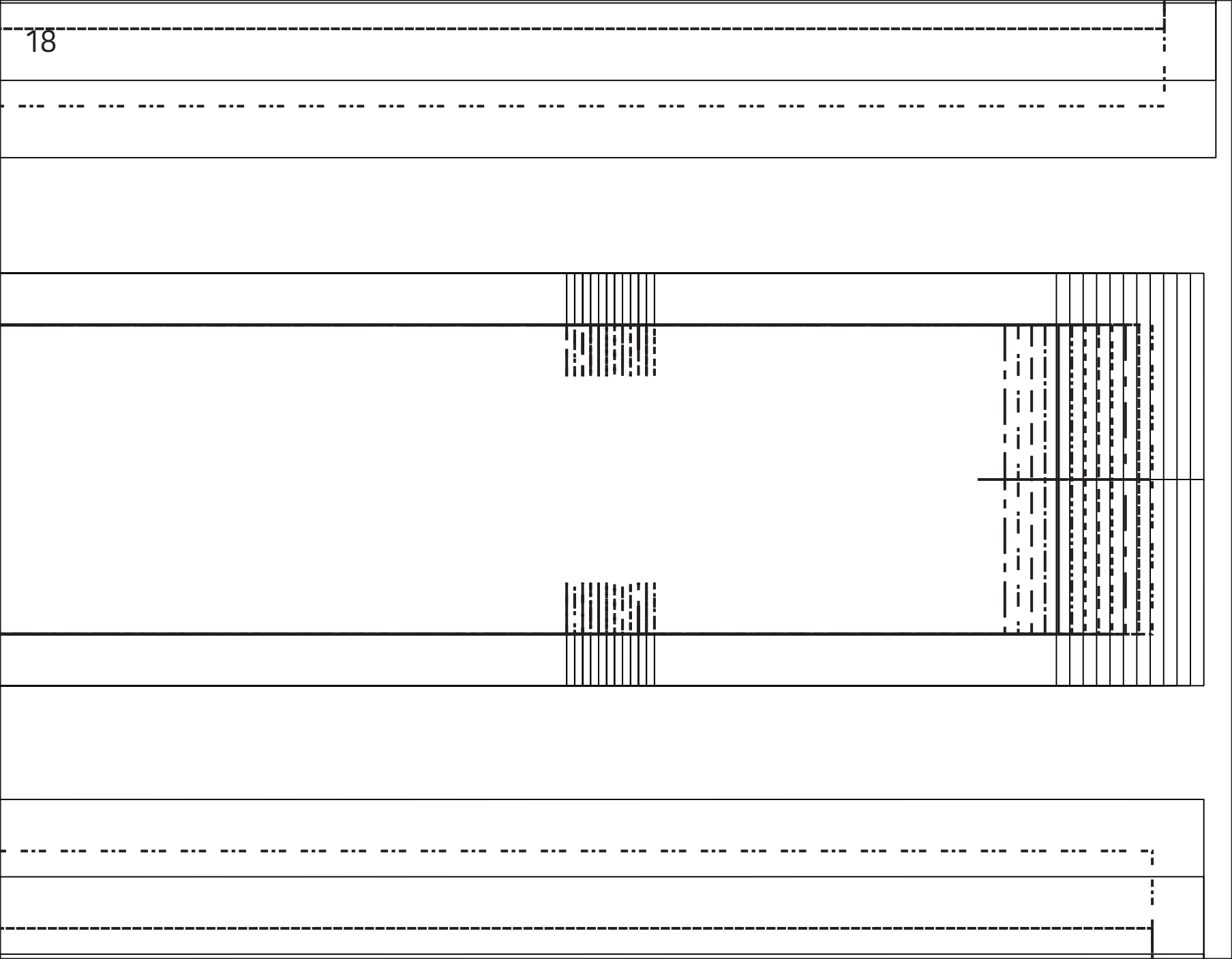

**D**

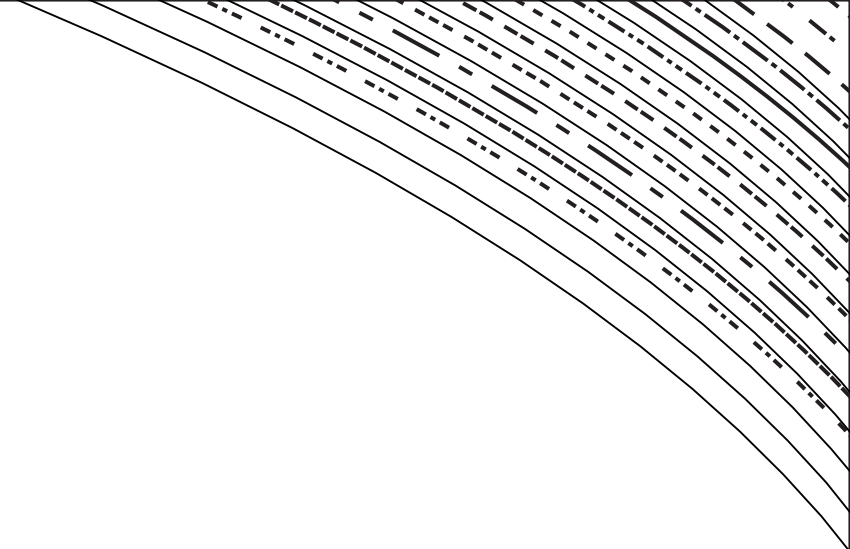

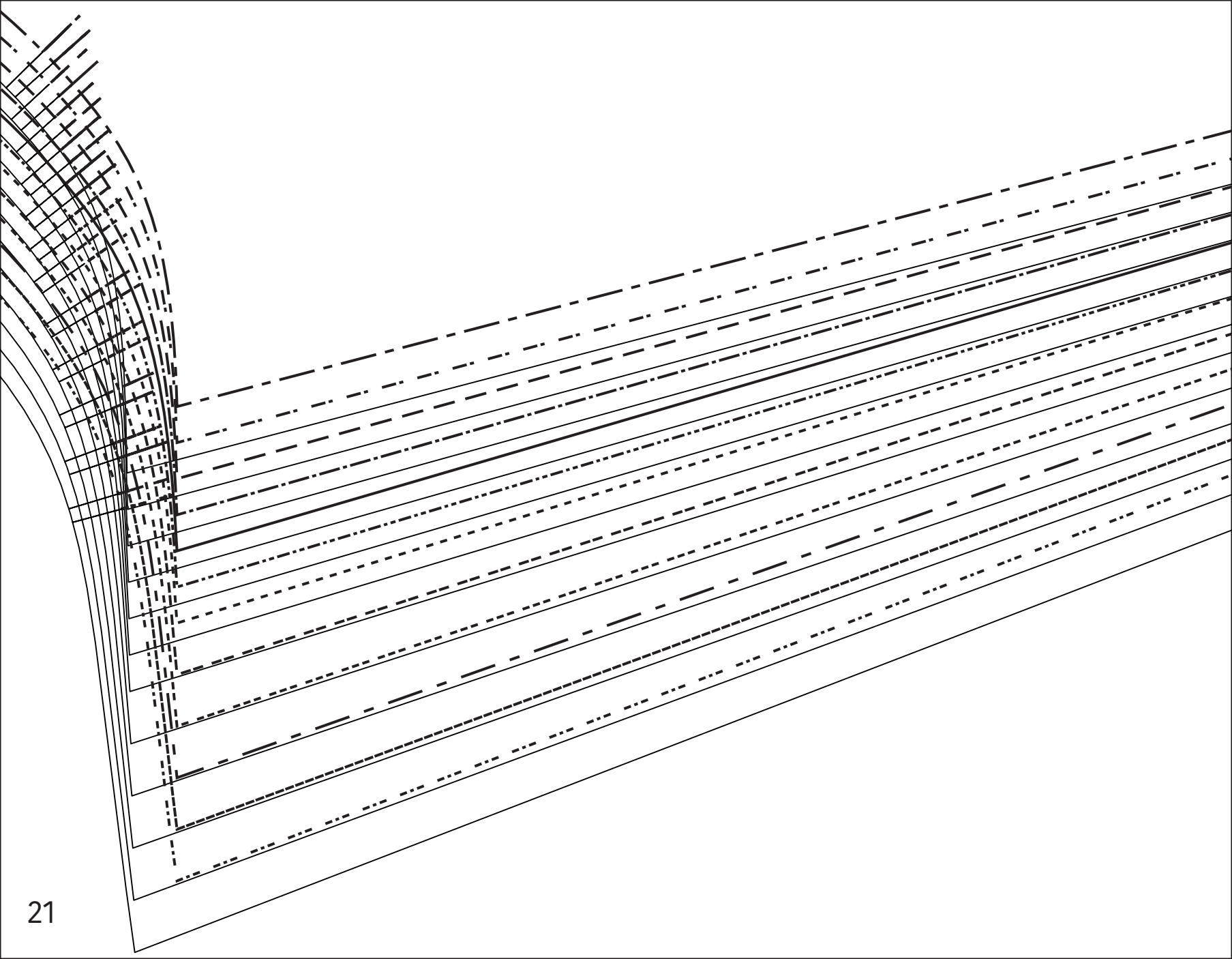

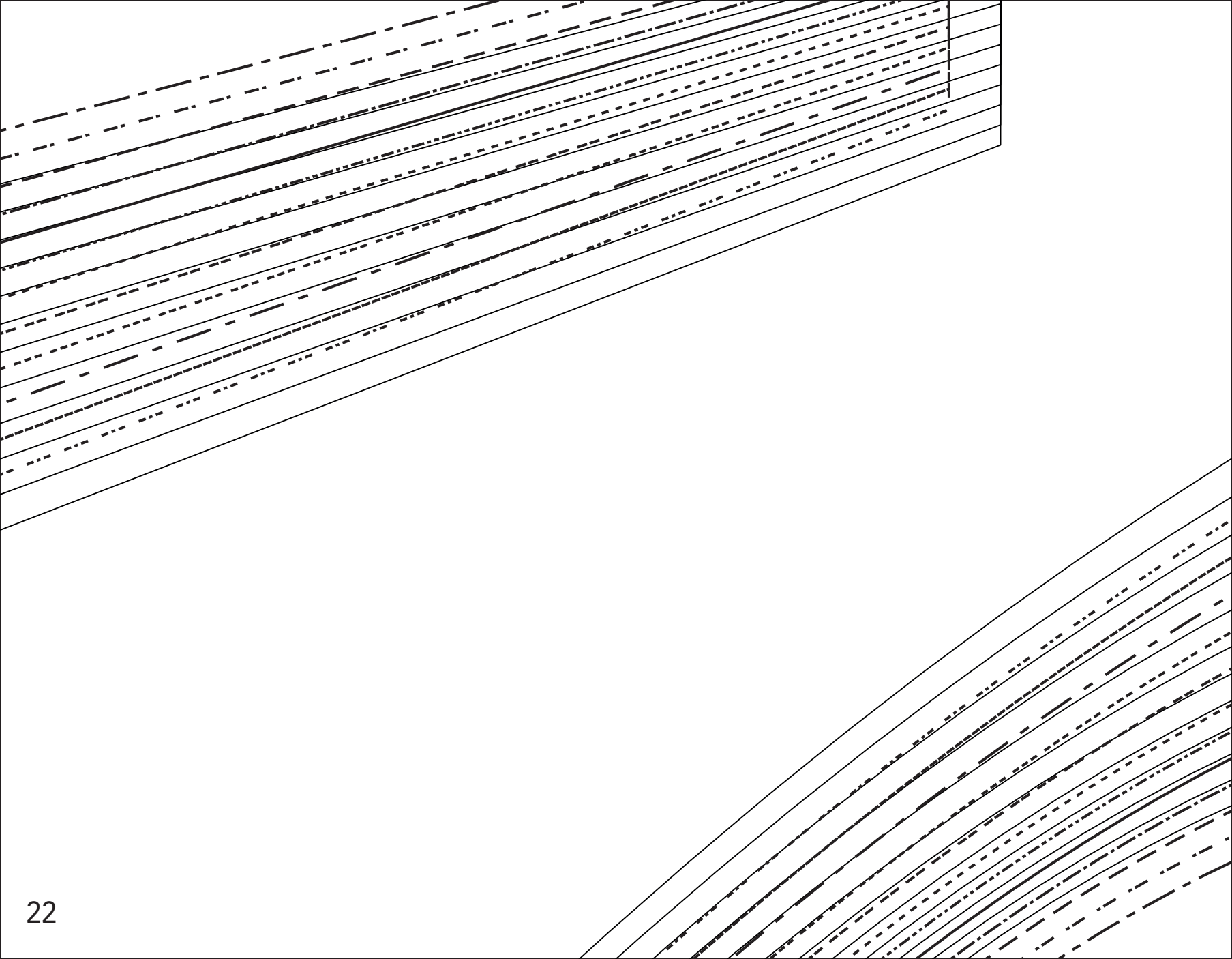

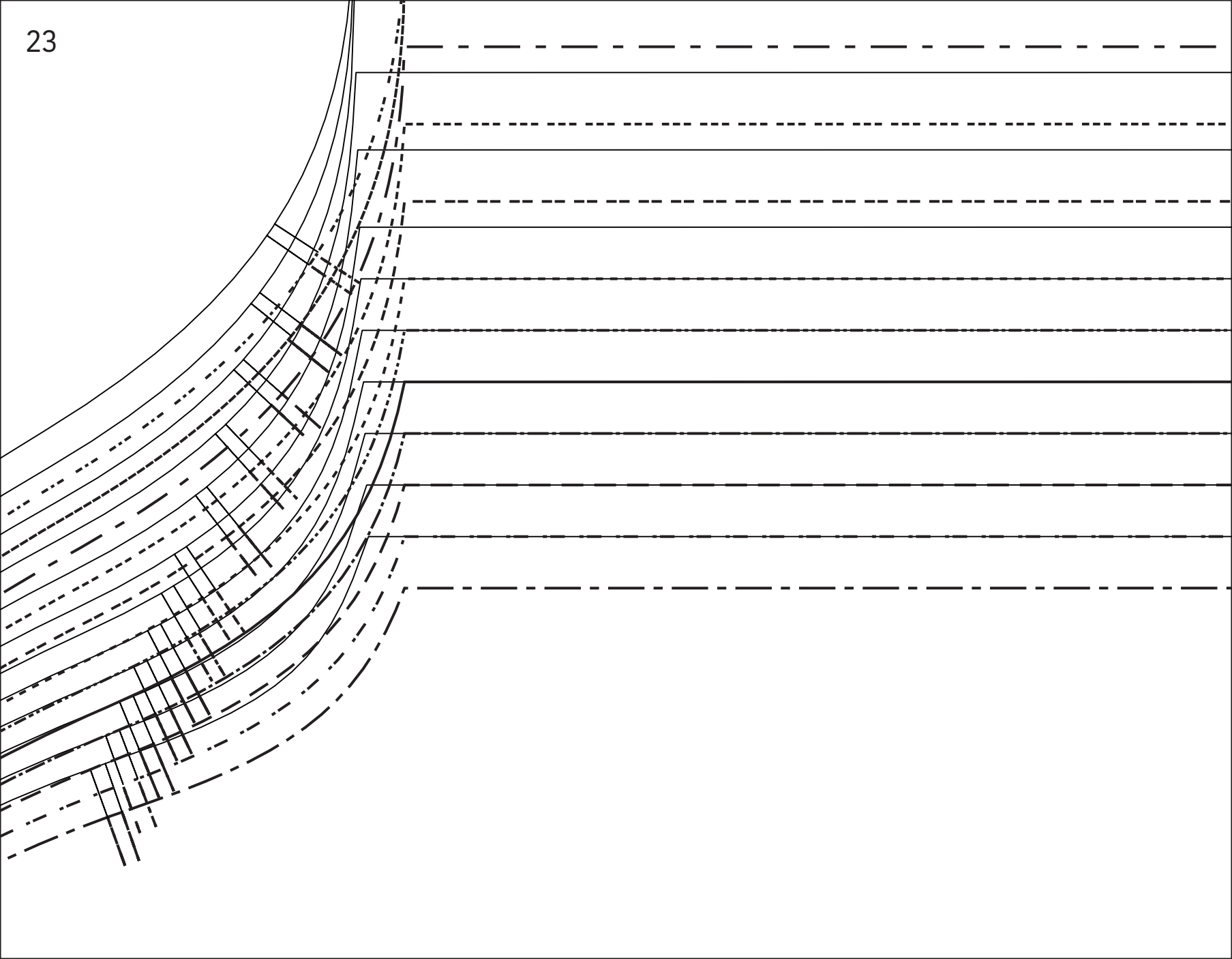

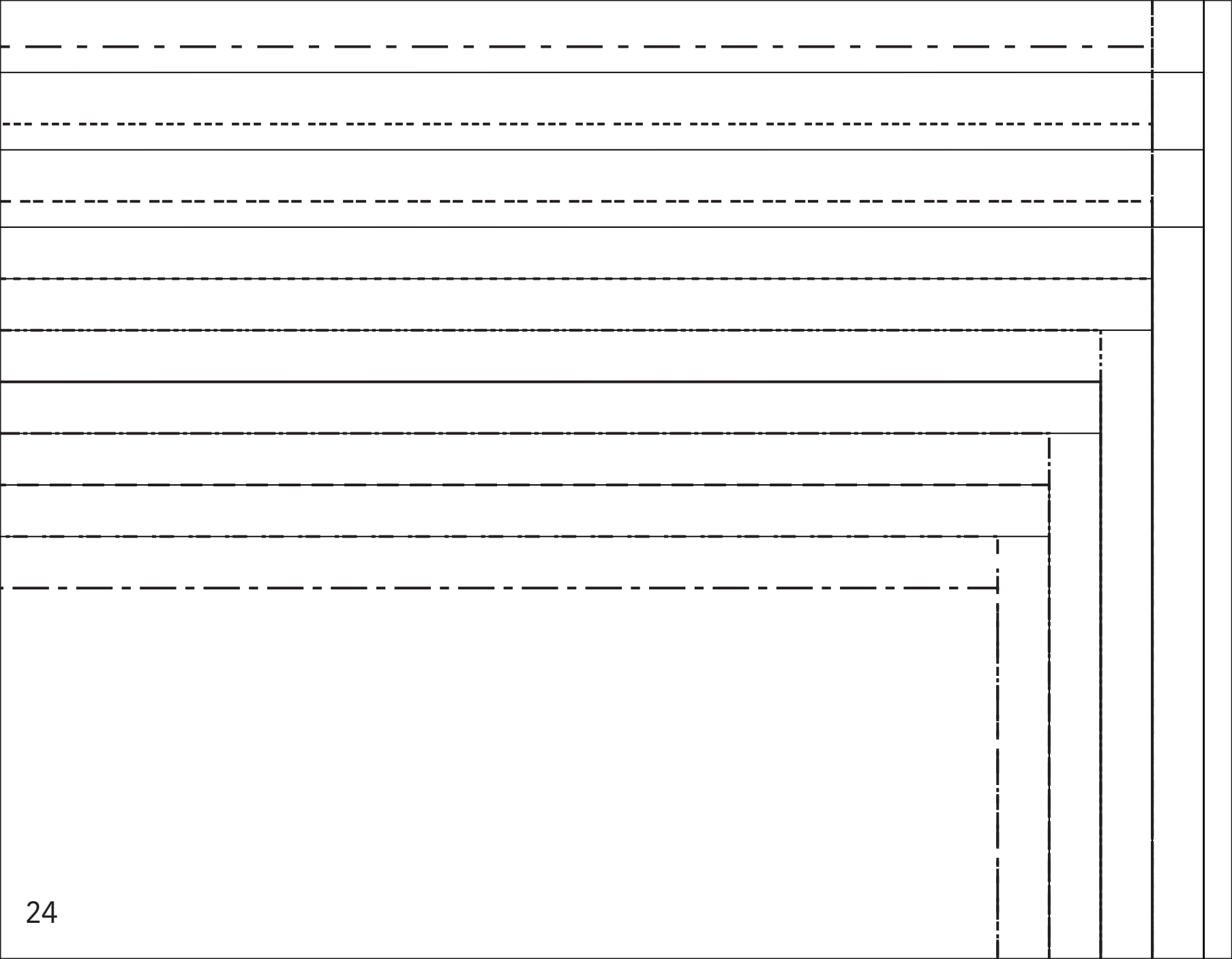









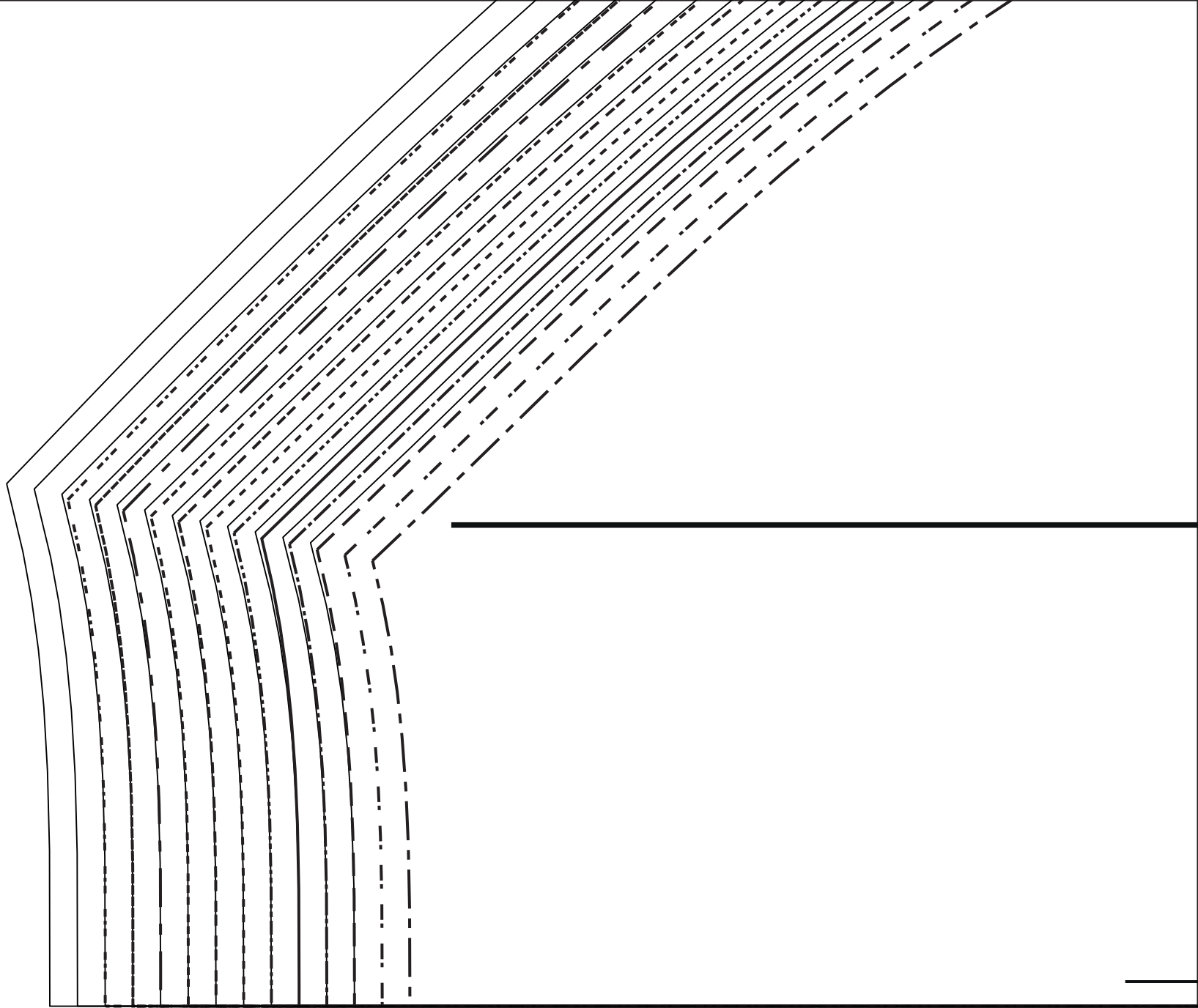

**B**



30

