

# Eve

## Jumpsuit / Combi

### Maten / Tailles / Sizes / Größen:

-----	34
- - - - -	36
-----	38
- - - - -	40
=====	42
- - - - -	44
-----	46
- - - - -	48
- - - - -	50
-----	52
- - - - -	54
-----	56

### Patroondelen / Pièces du patron / Pattern pieces / Schnittteile:

- A** VP top / DV haut / top FP /  
Vorderteil Top
- B** RP top / DS haut / top BP /  
Rückenteil Top
- C** VP broek / DV pantalon / FP trousers /  
VT Hose
- D** rugpand broek / DS pantalon /  
BP trousers / RT Hose
- E** beleg VP / parementure DV /  
facing FP / Besatz VT
- F** beleg RP / parementure DS /  
facing BP / Besatz RT
- G** zak / poche / pocket / Tasche

### Patroonschema / Schéma du Patron / Pattern Diagram / Übersichtsplan zum Zusammenkleben

1	2	3	4	5	6	7
8	9	10	11	12	13	14
15	16	17	18	19	20	21
22	23	24	25	26	27	28
29	30	31	32	33	34	35
36	37	38	39	40	41	42
X	X	45	46	47	48	49

Controlevierkant / Carré de controle  
/ Test square / Kontrollquadrat

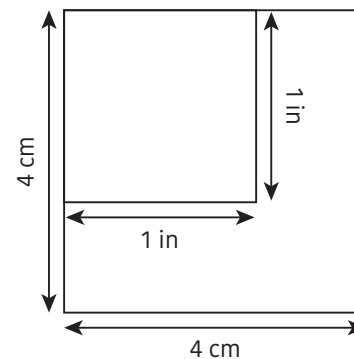

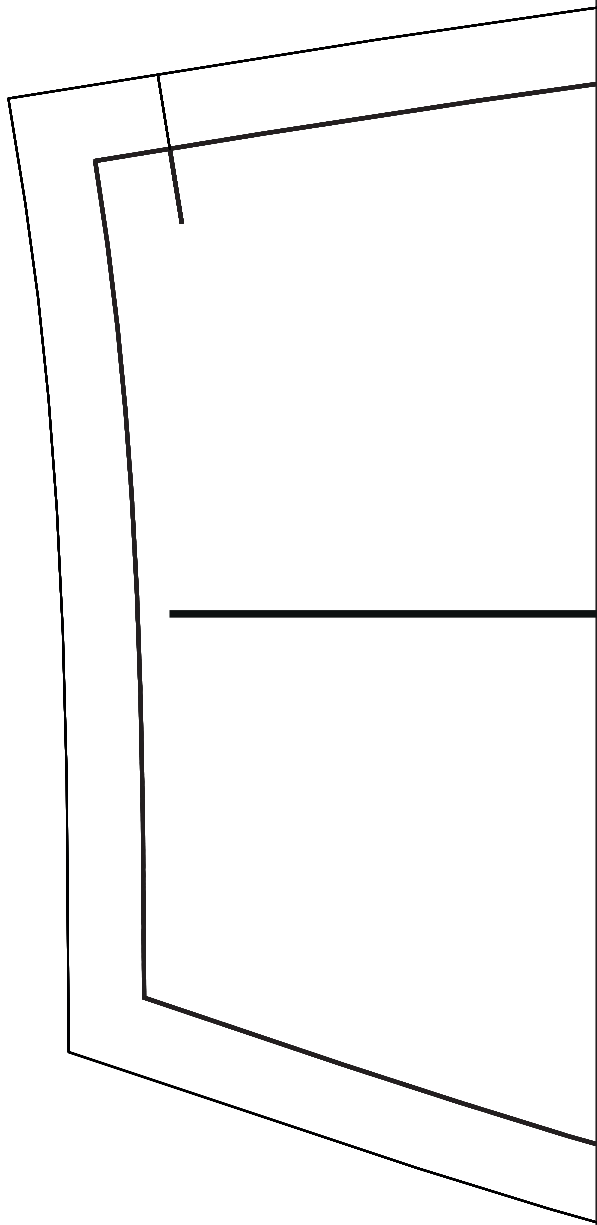
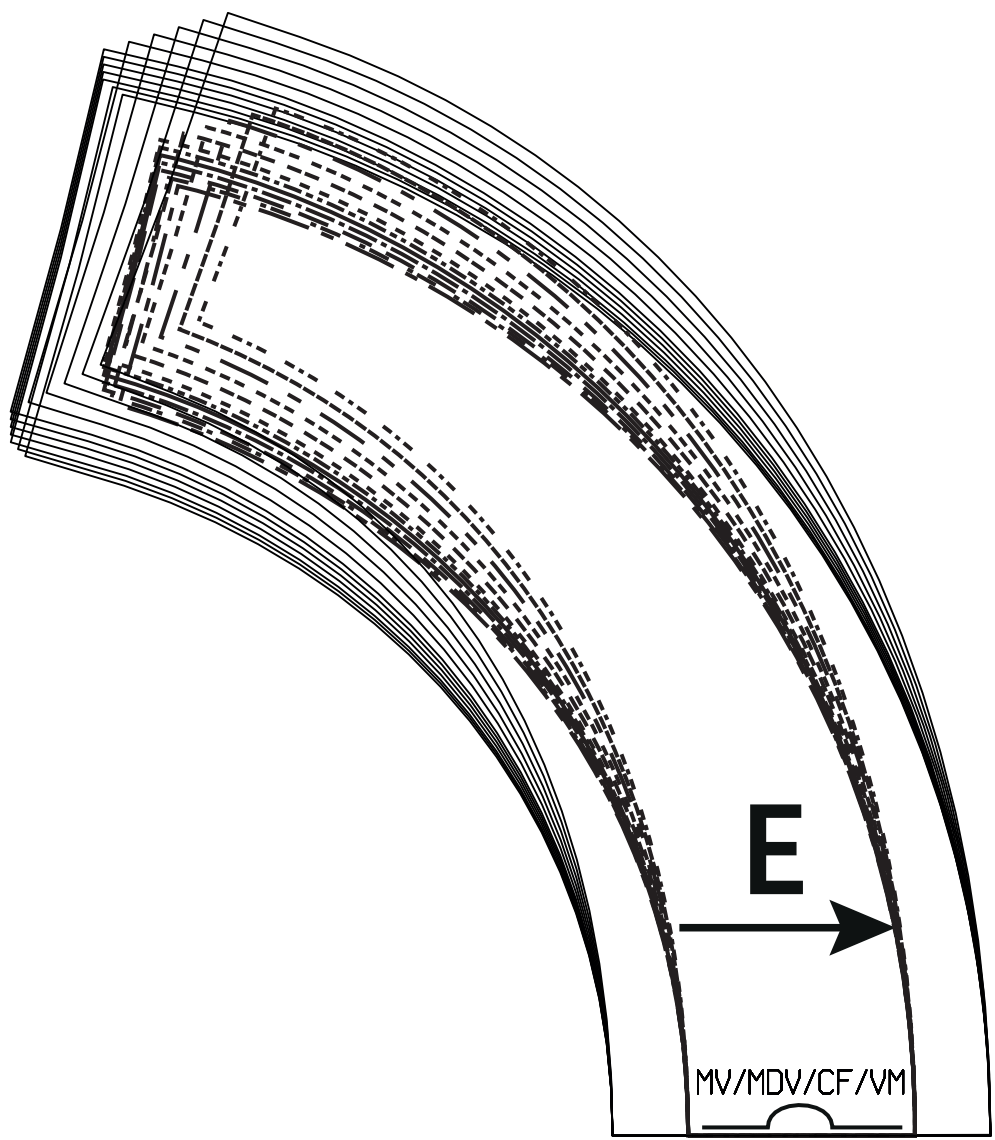



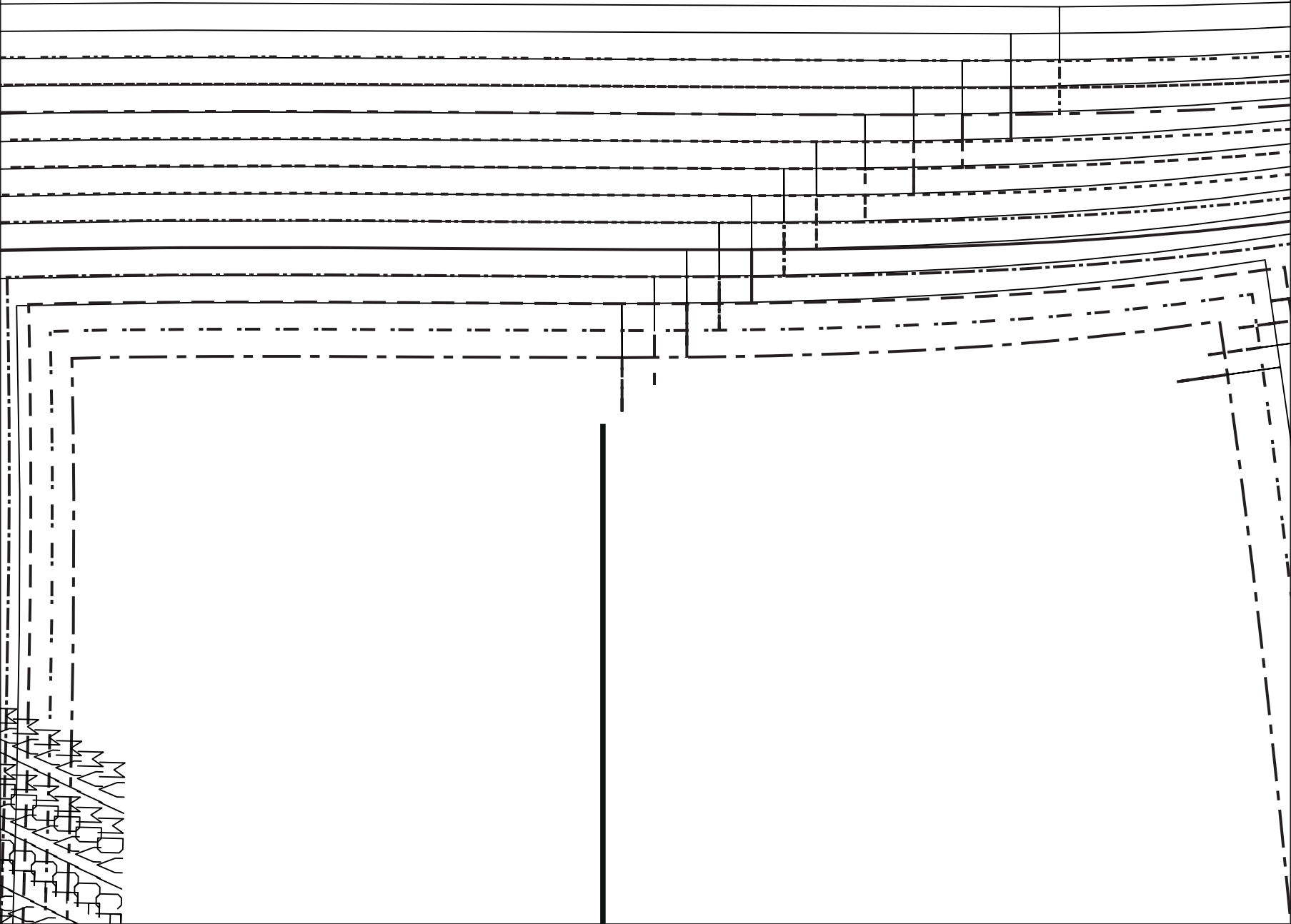

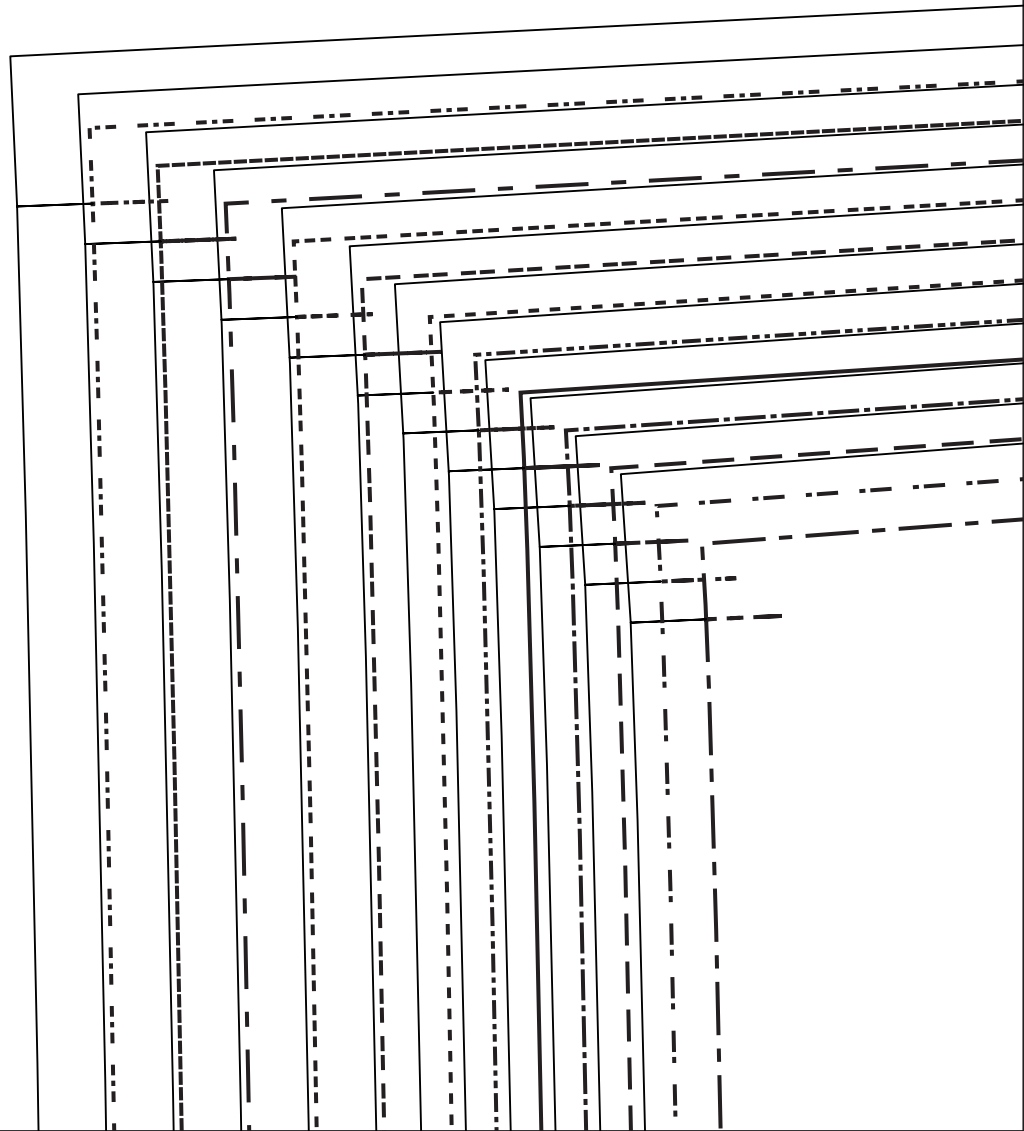
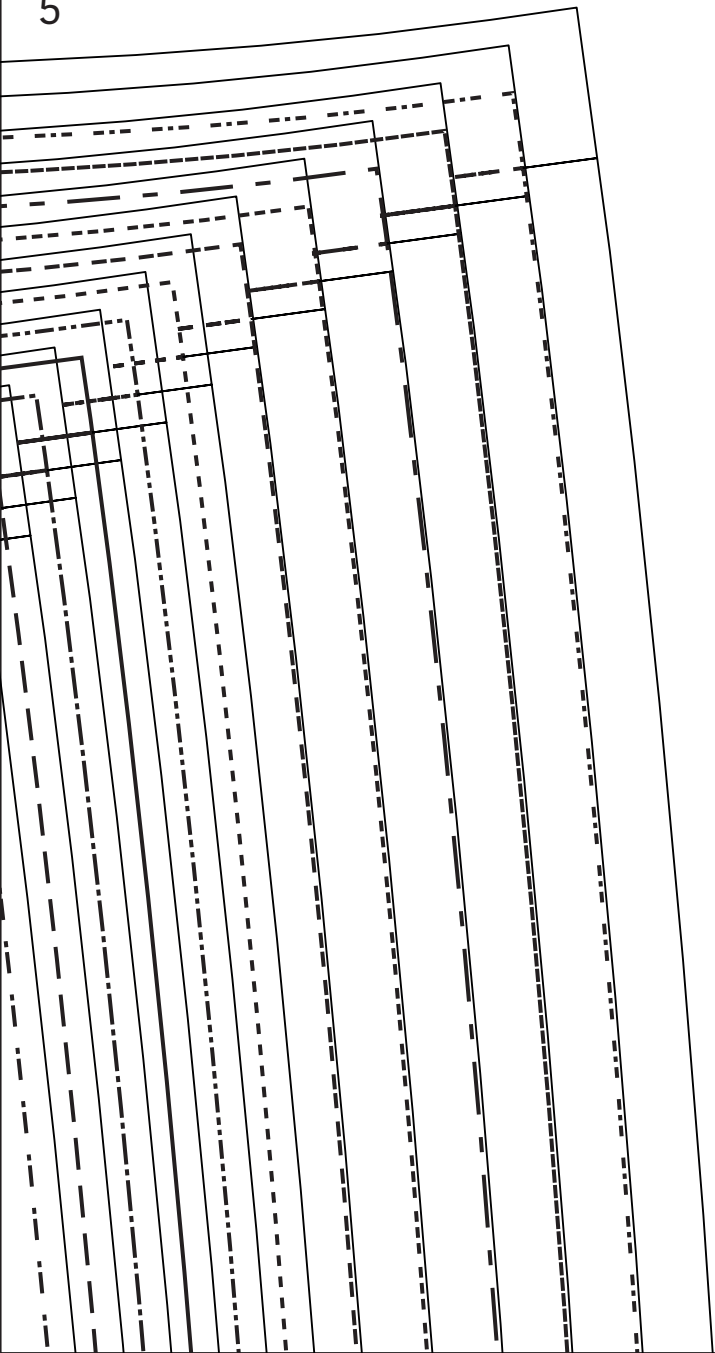

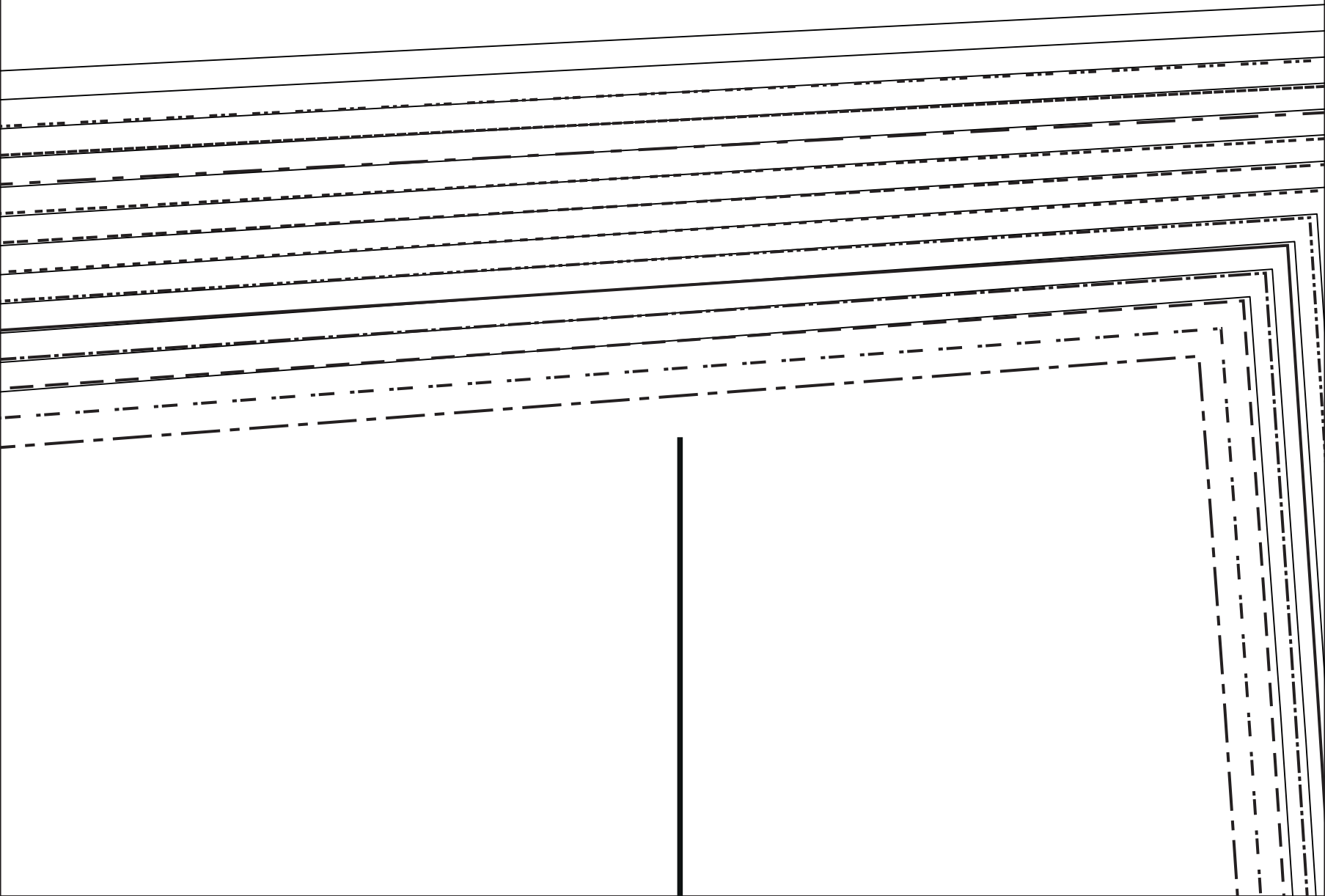

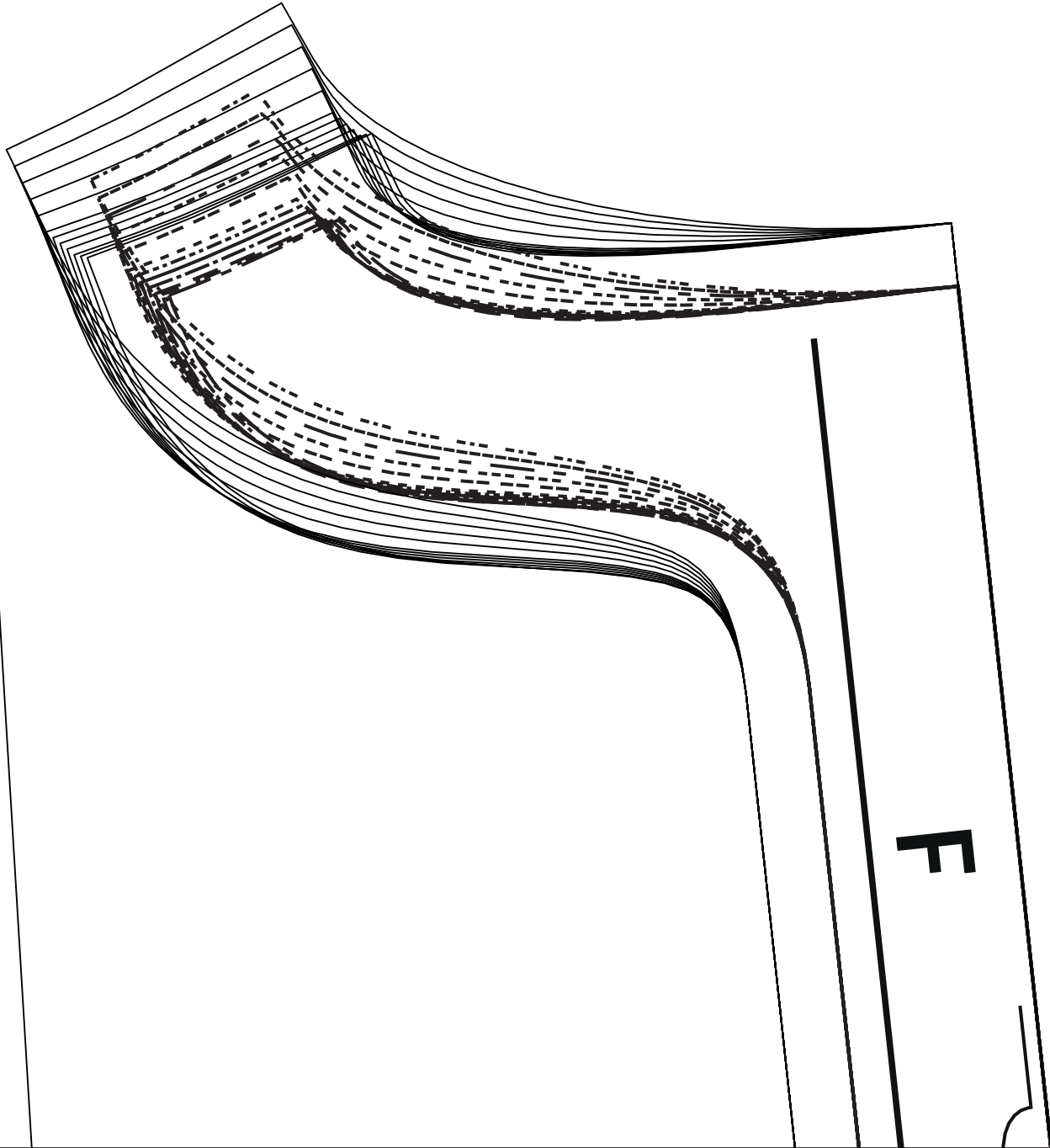
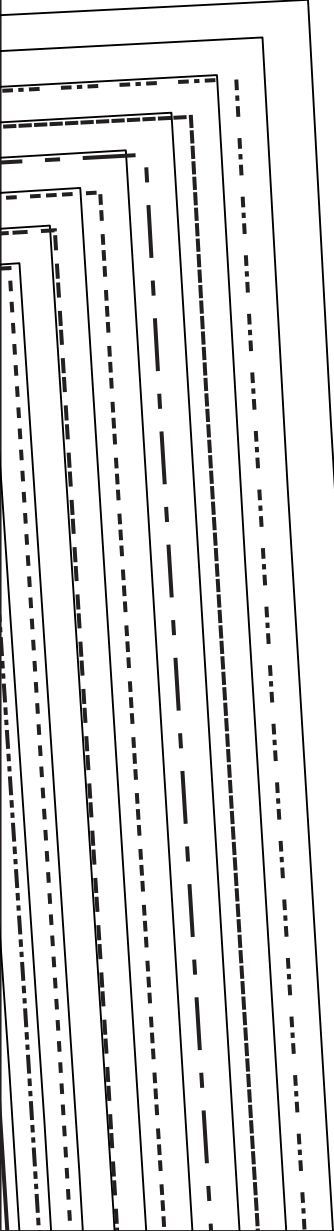

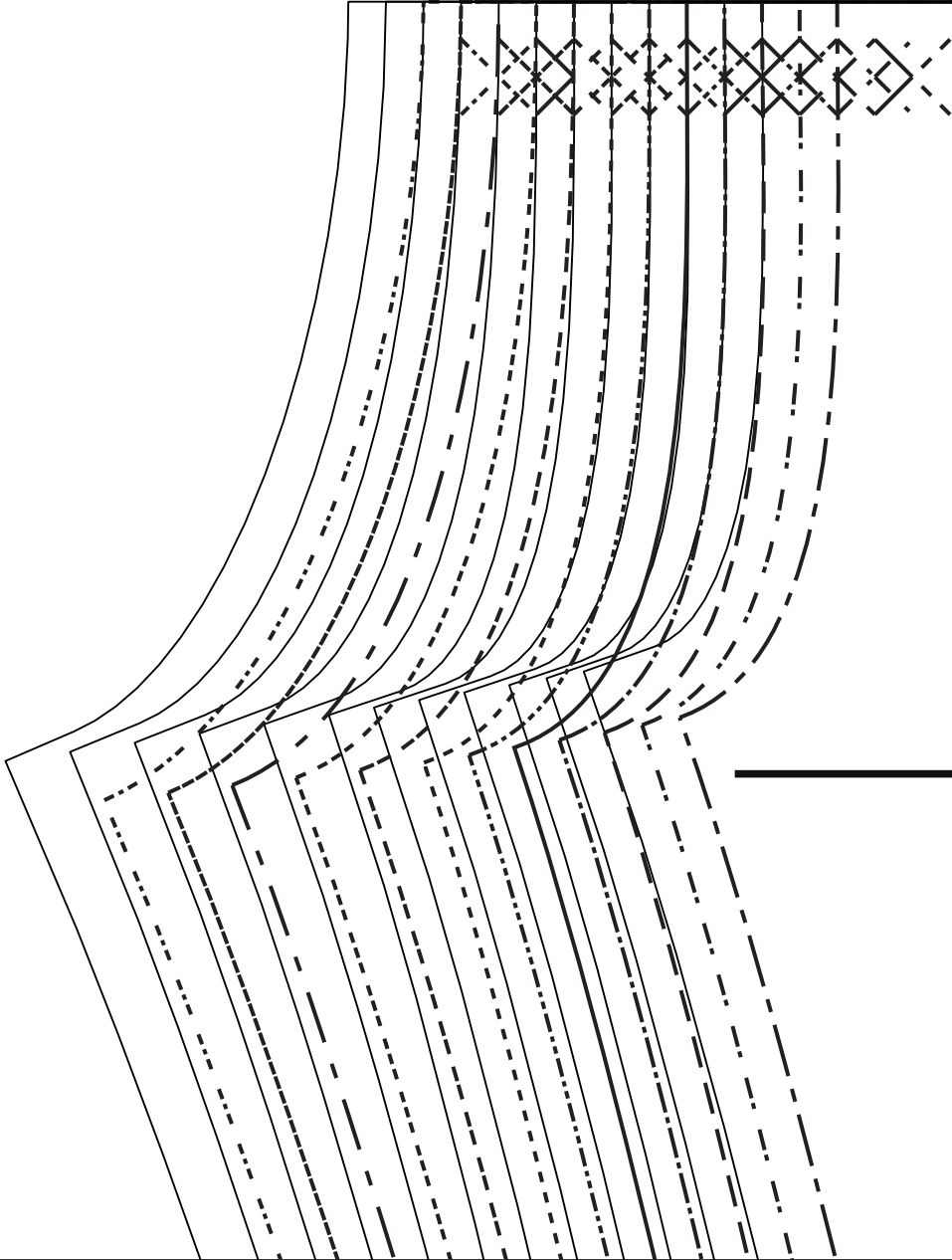





W

**B**

MR/MDS/CB/R

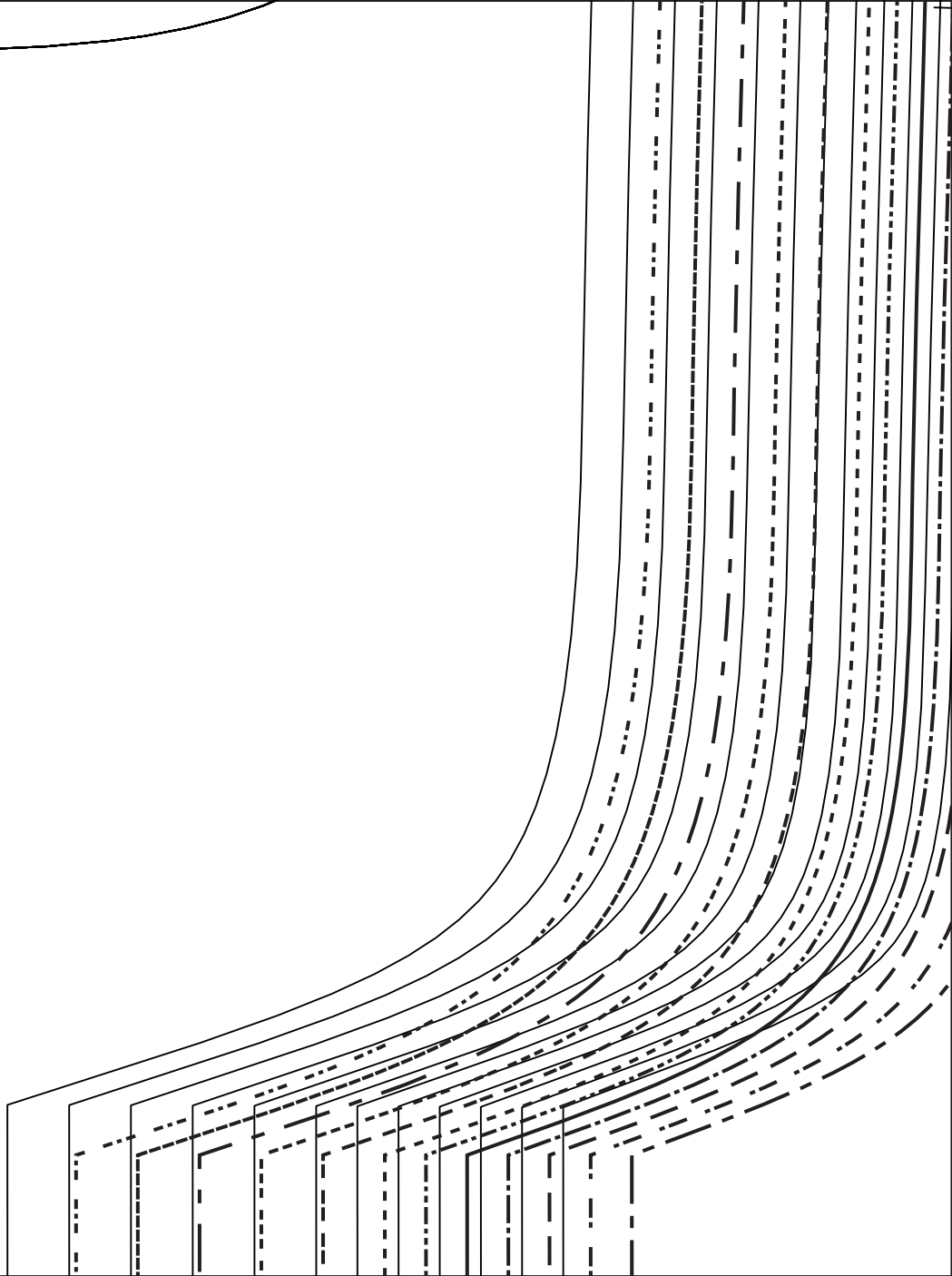

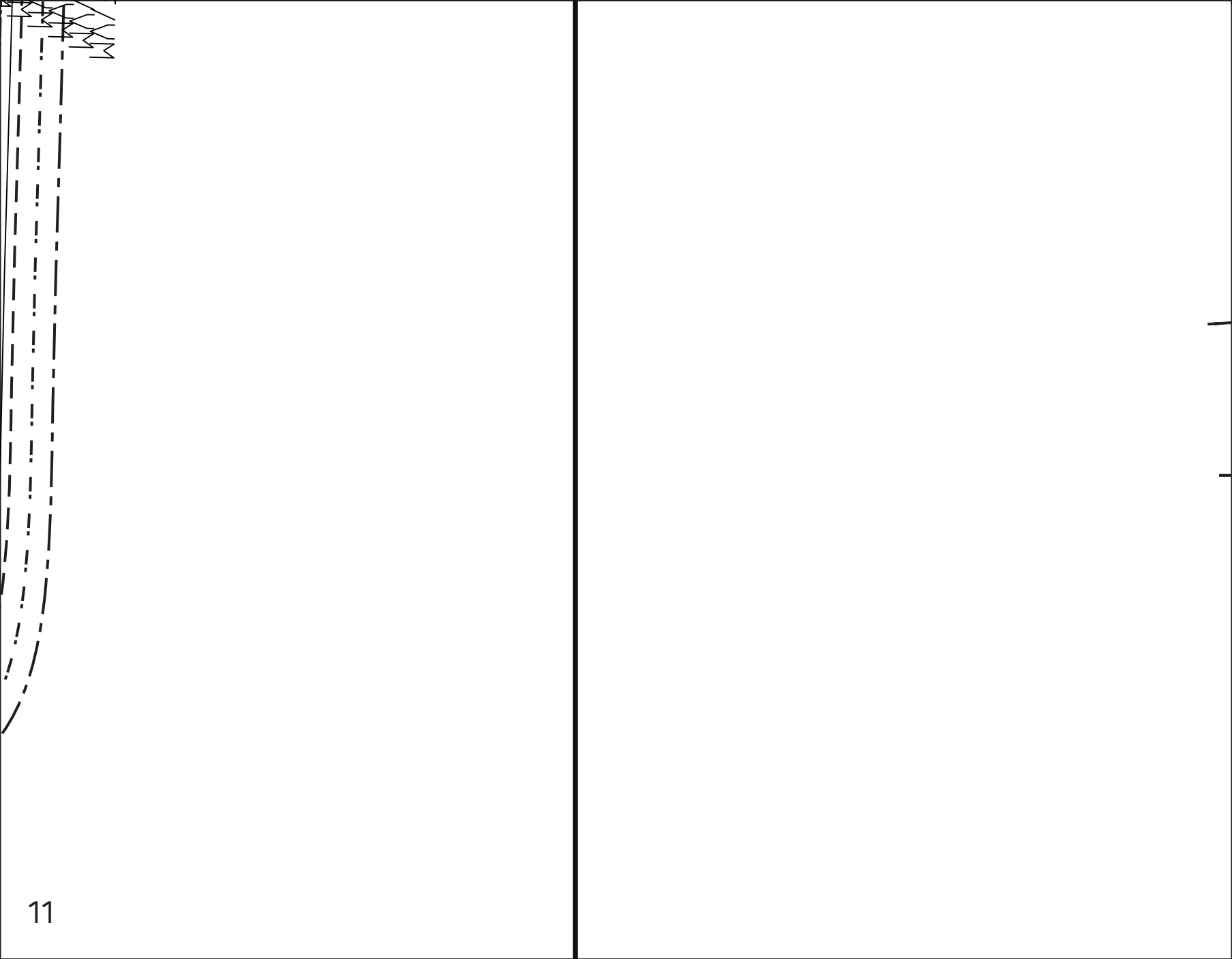

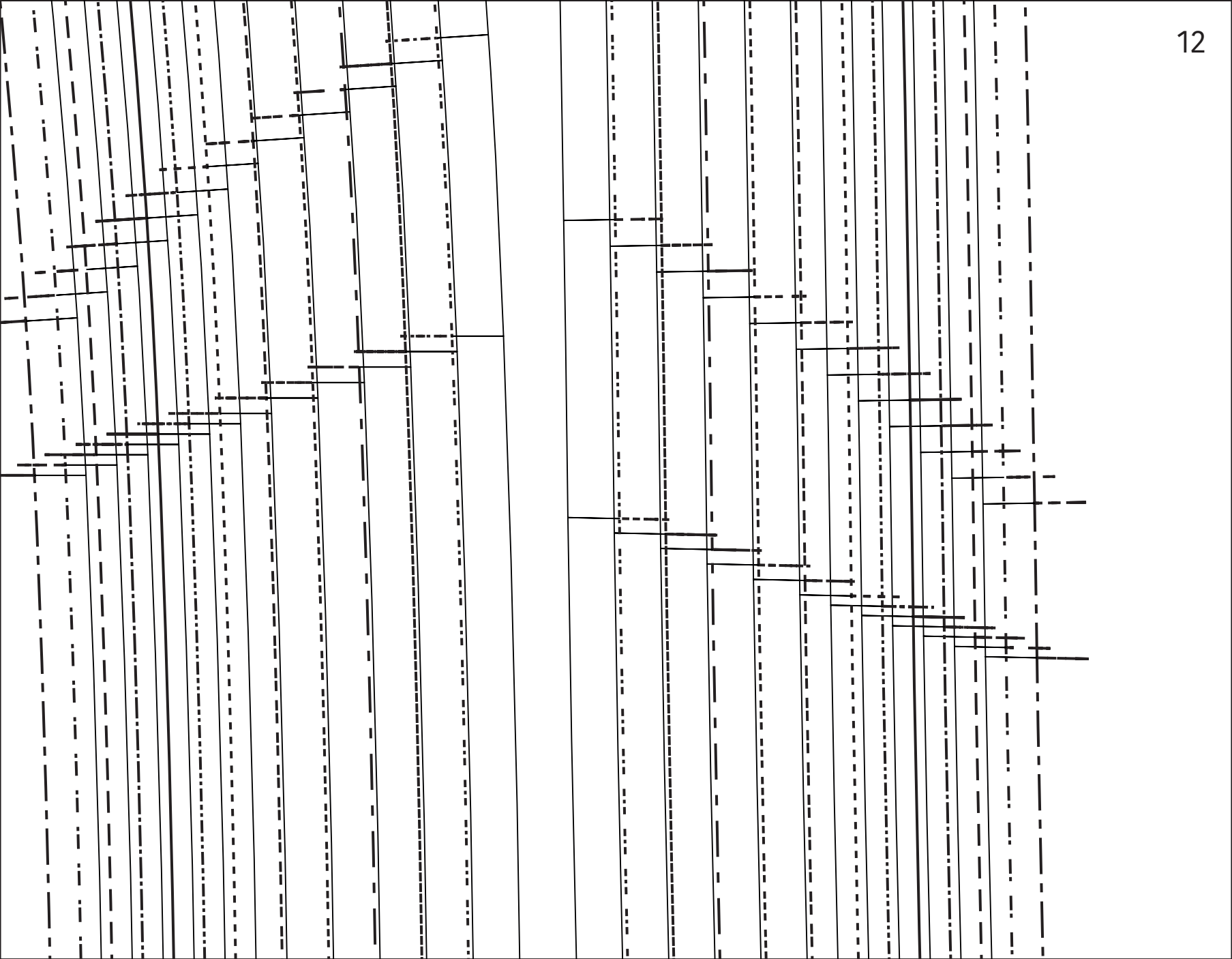

MR/MDS/CB/PM  
MR/MDS/CB/PM  
MR/MDS/CB/PM  
MR/MDS/CB/PM  
MR/MDS/CB/PM  
MR/MDS/CB/PM  
MR/MDS/CB/PM

~~MR/MDS/CB/RM~~  
~~MR/MDS/CB/RM~~  
~~MR/MDS/CB/RM~~  
~~MR/MDS/CB/RM~~  
~~MR/MDS/CB/RM~~  
~~MR/MDS/CB/RM~~  
~~MR/MDS/CB/RM~~

MR/MDS/CB/RM

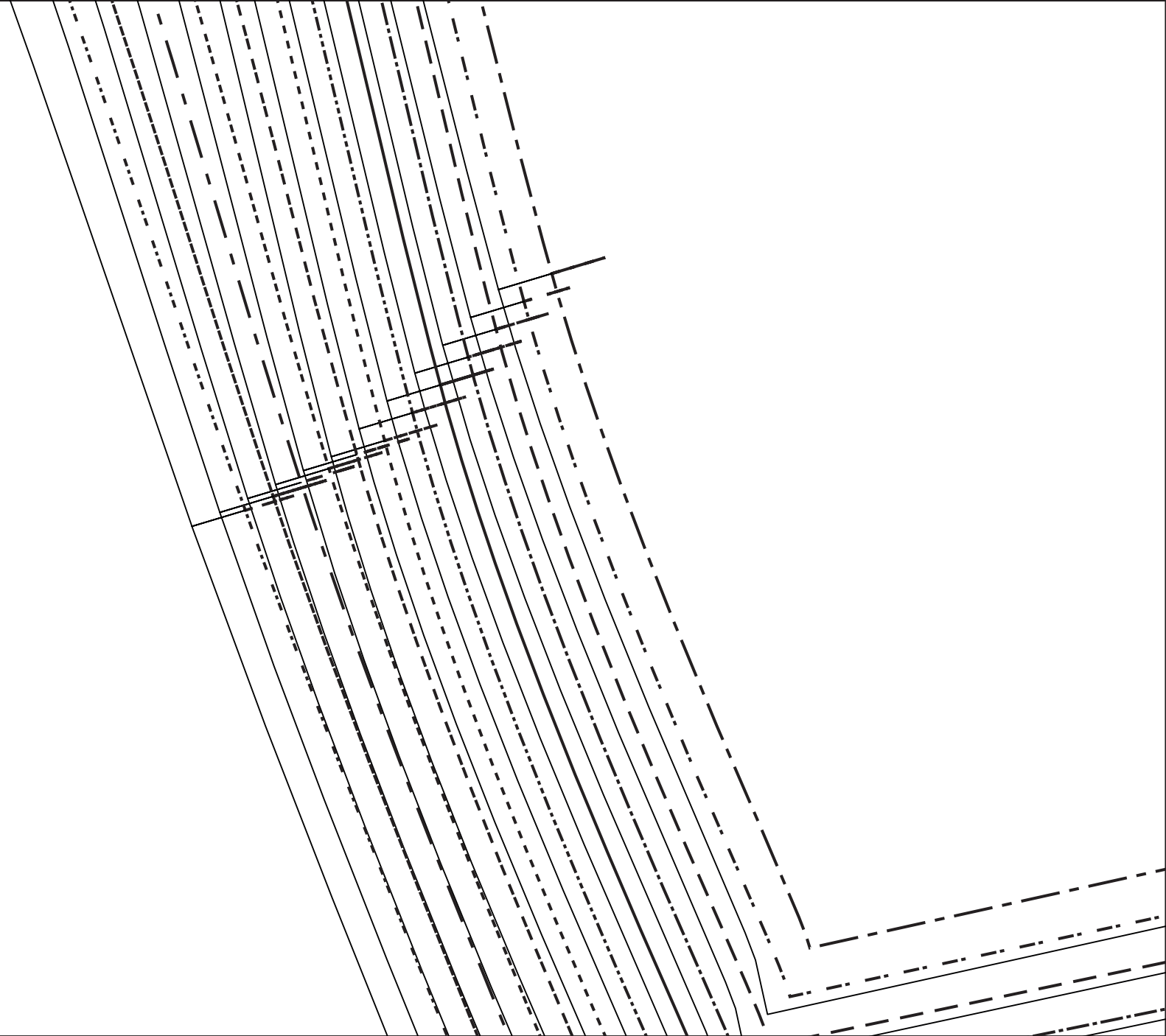

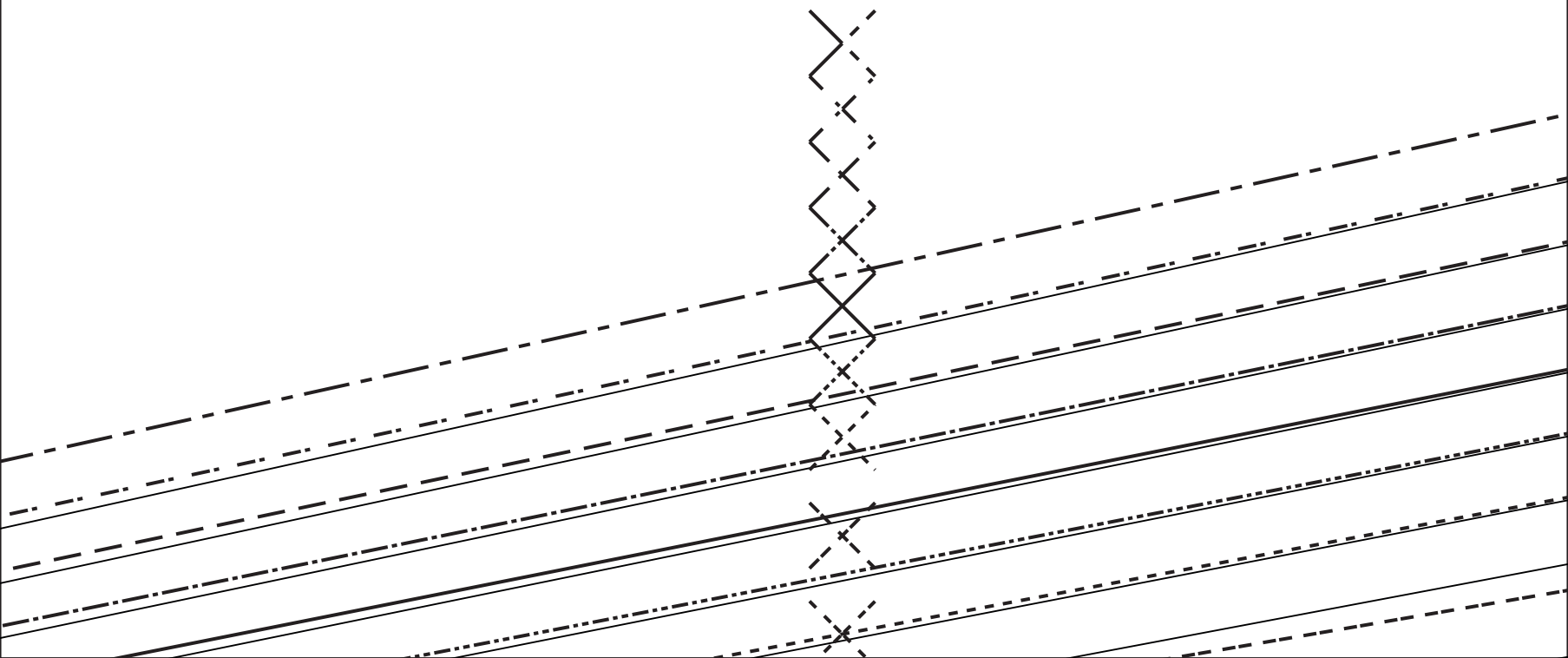



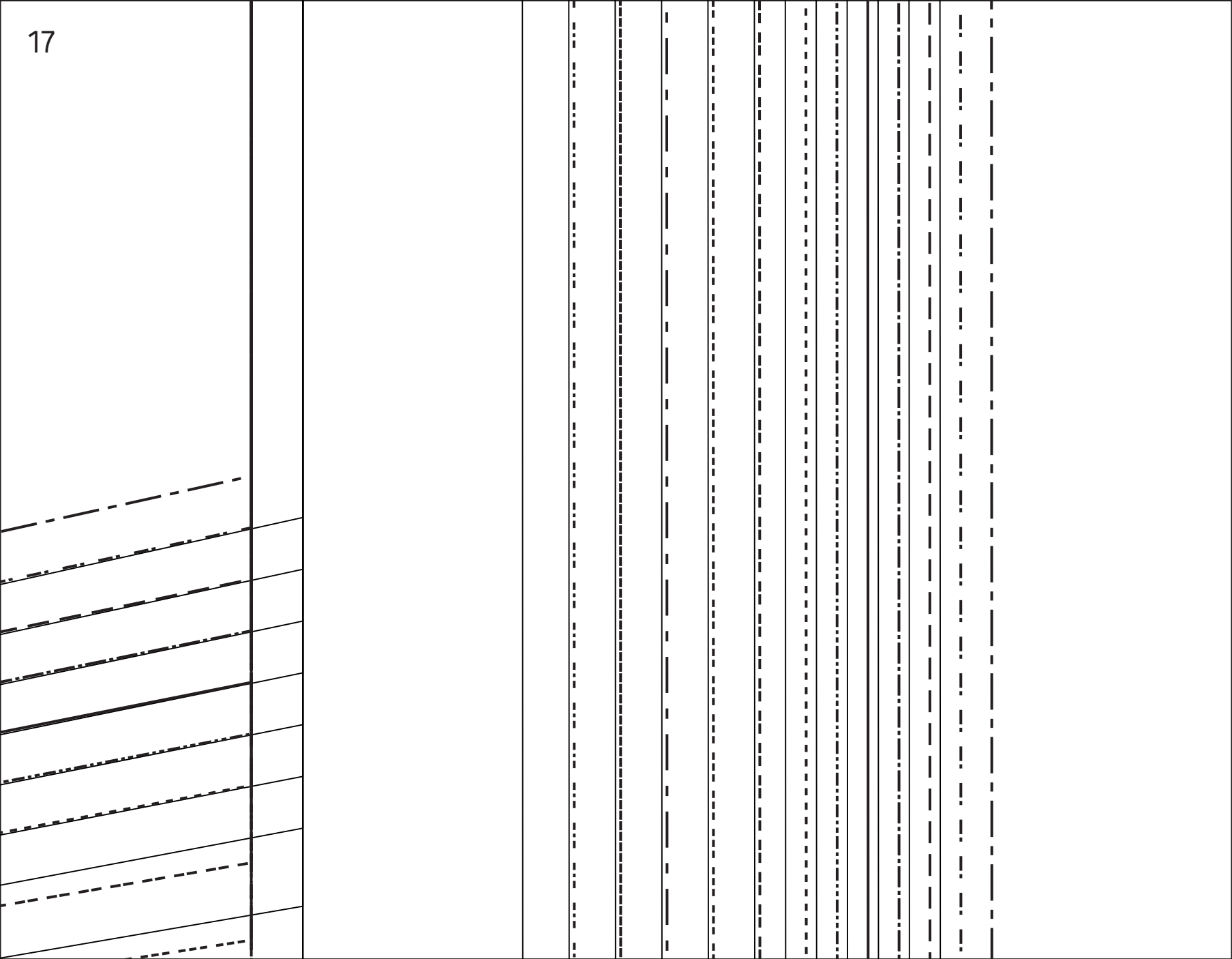







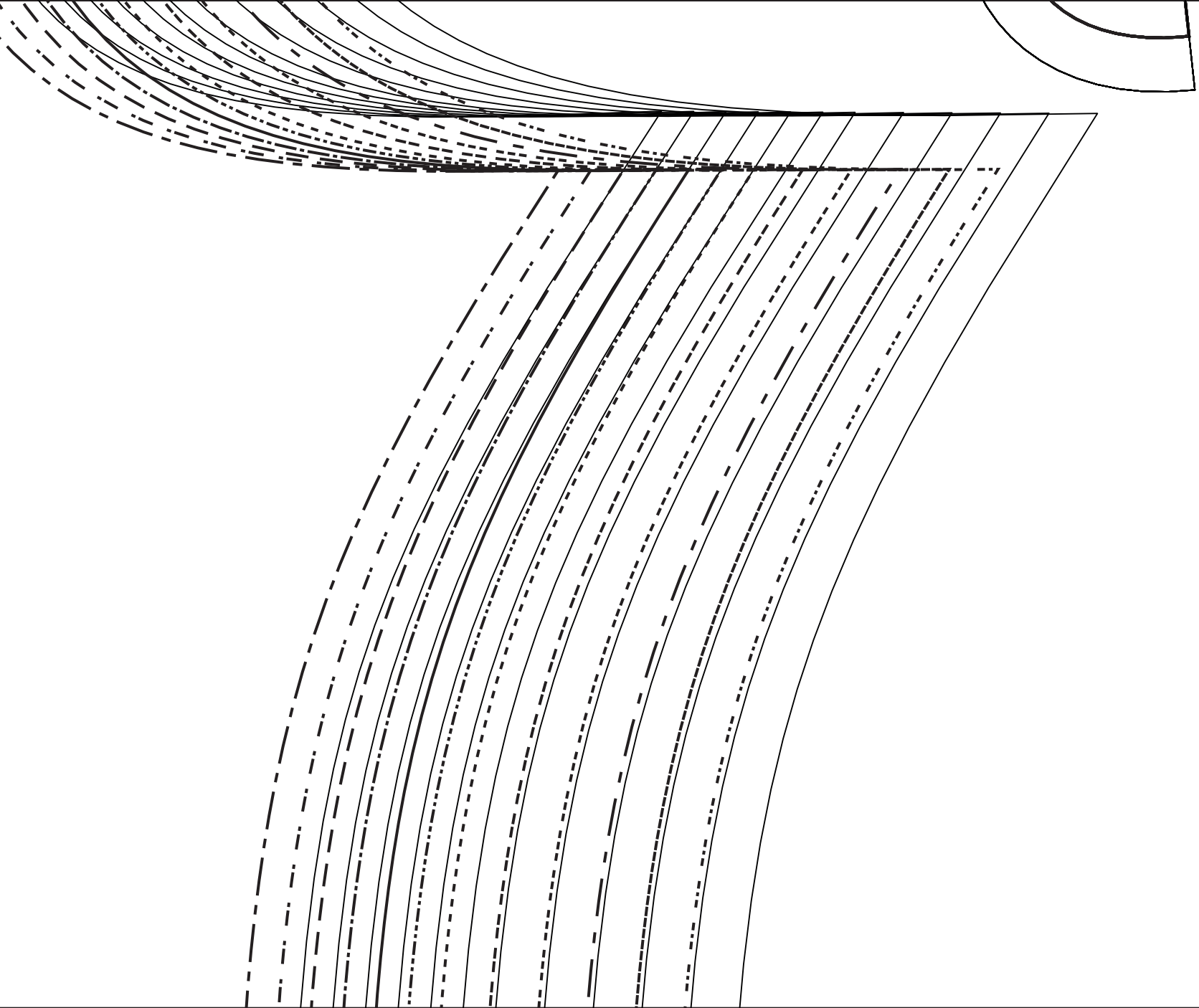

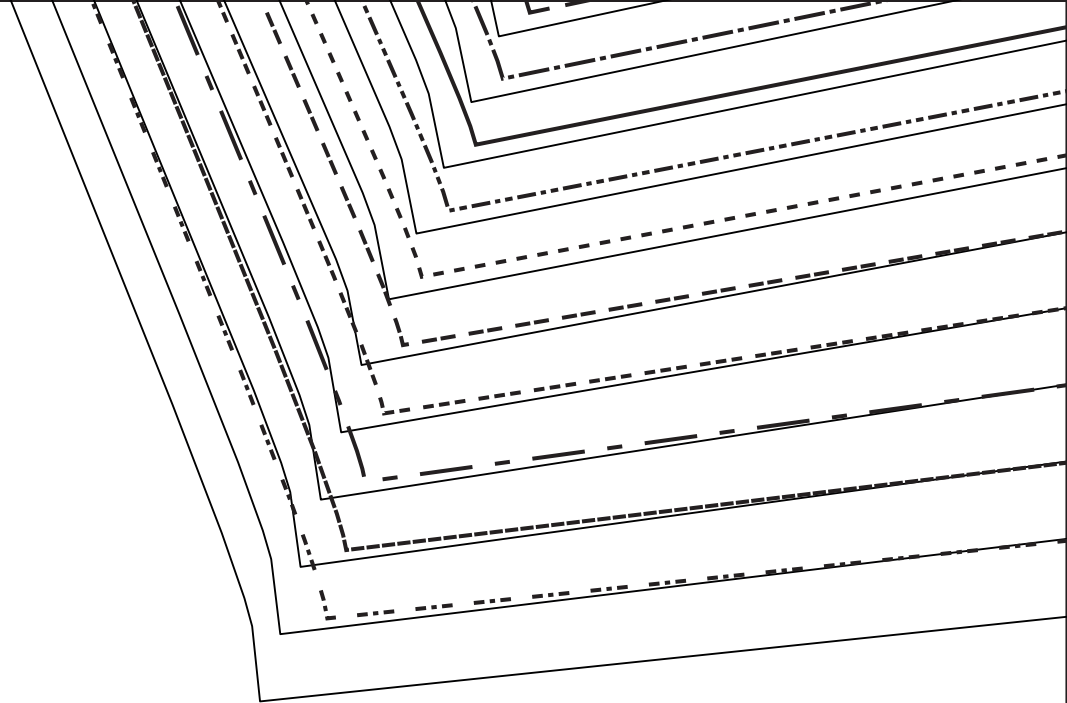

MV/MDV/CF/YM



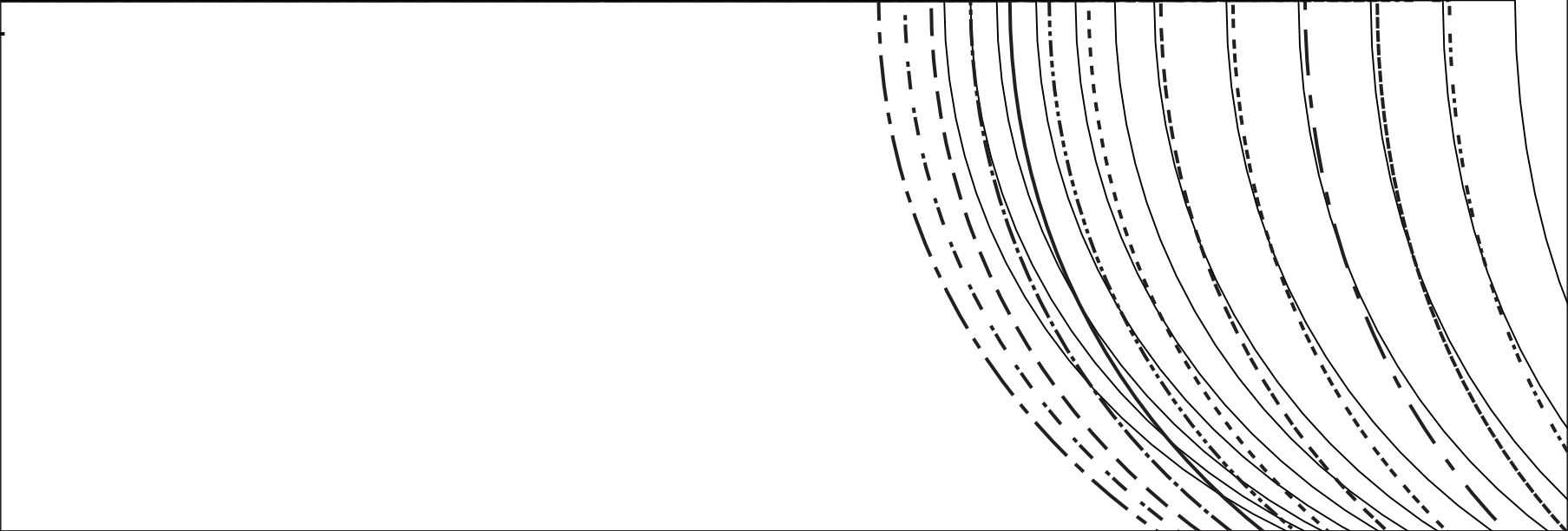
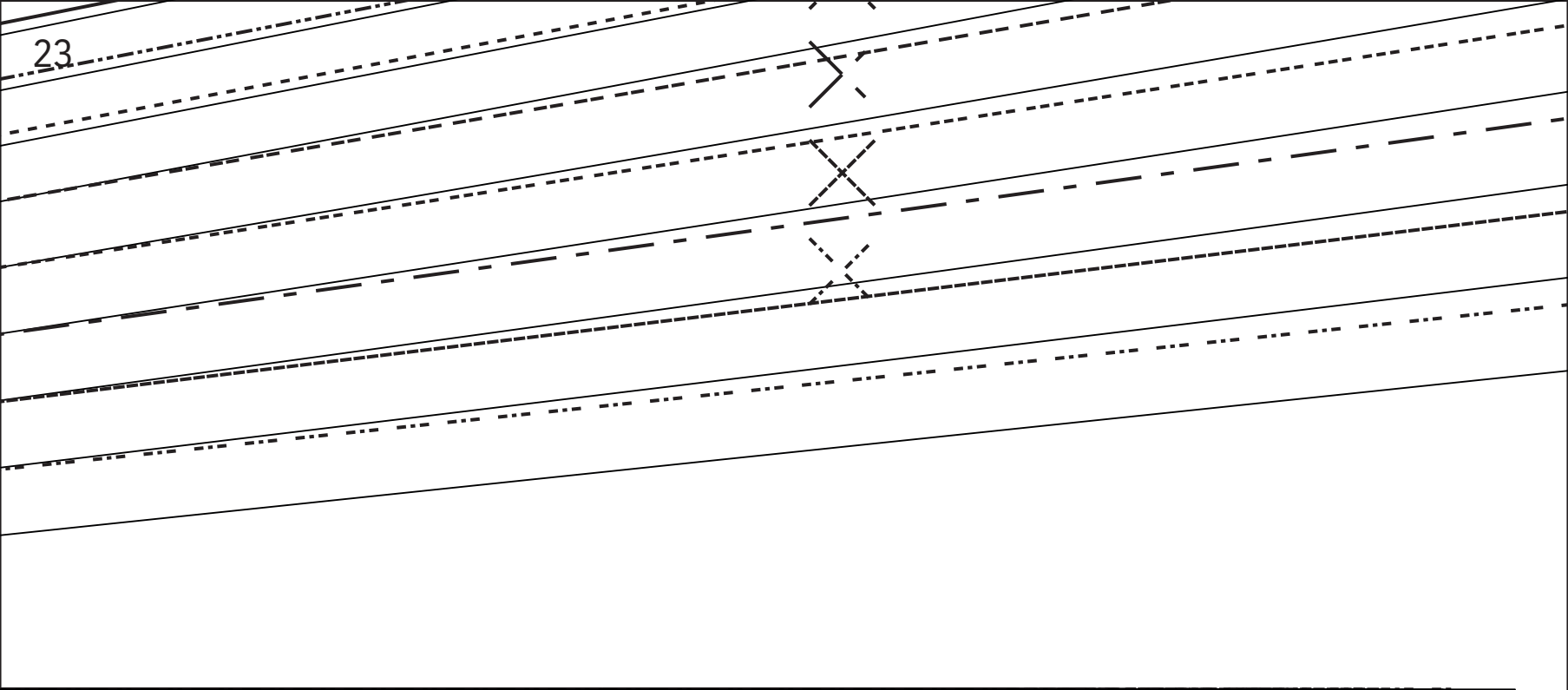

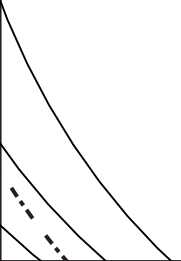
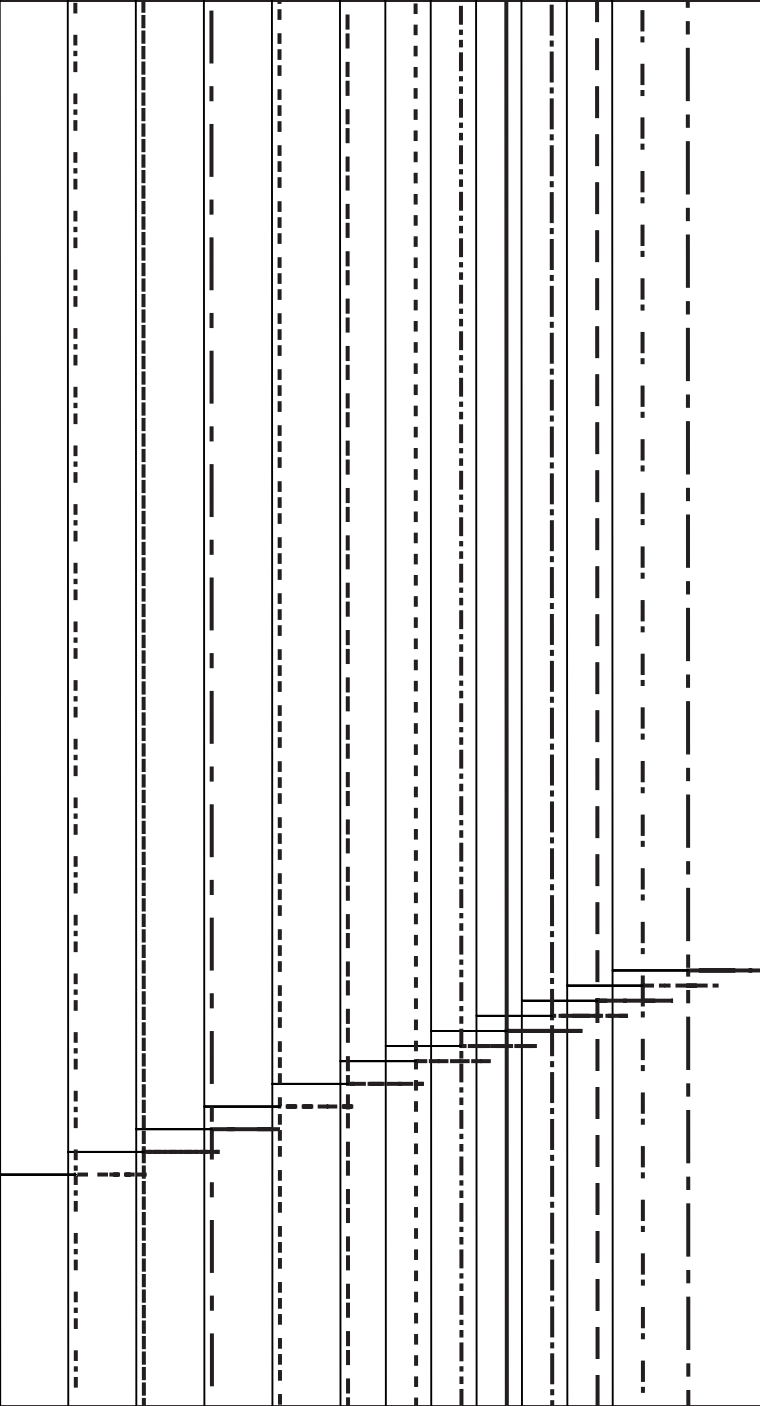
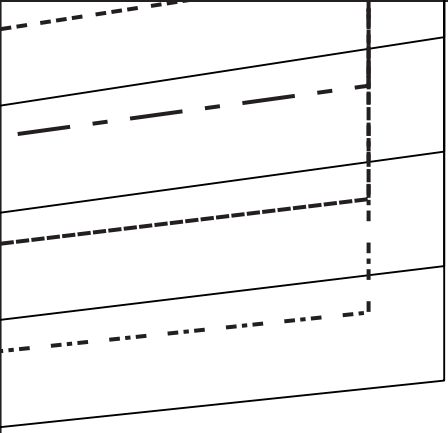



С

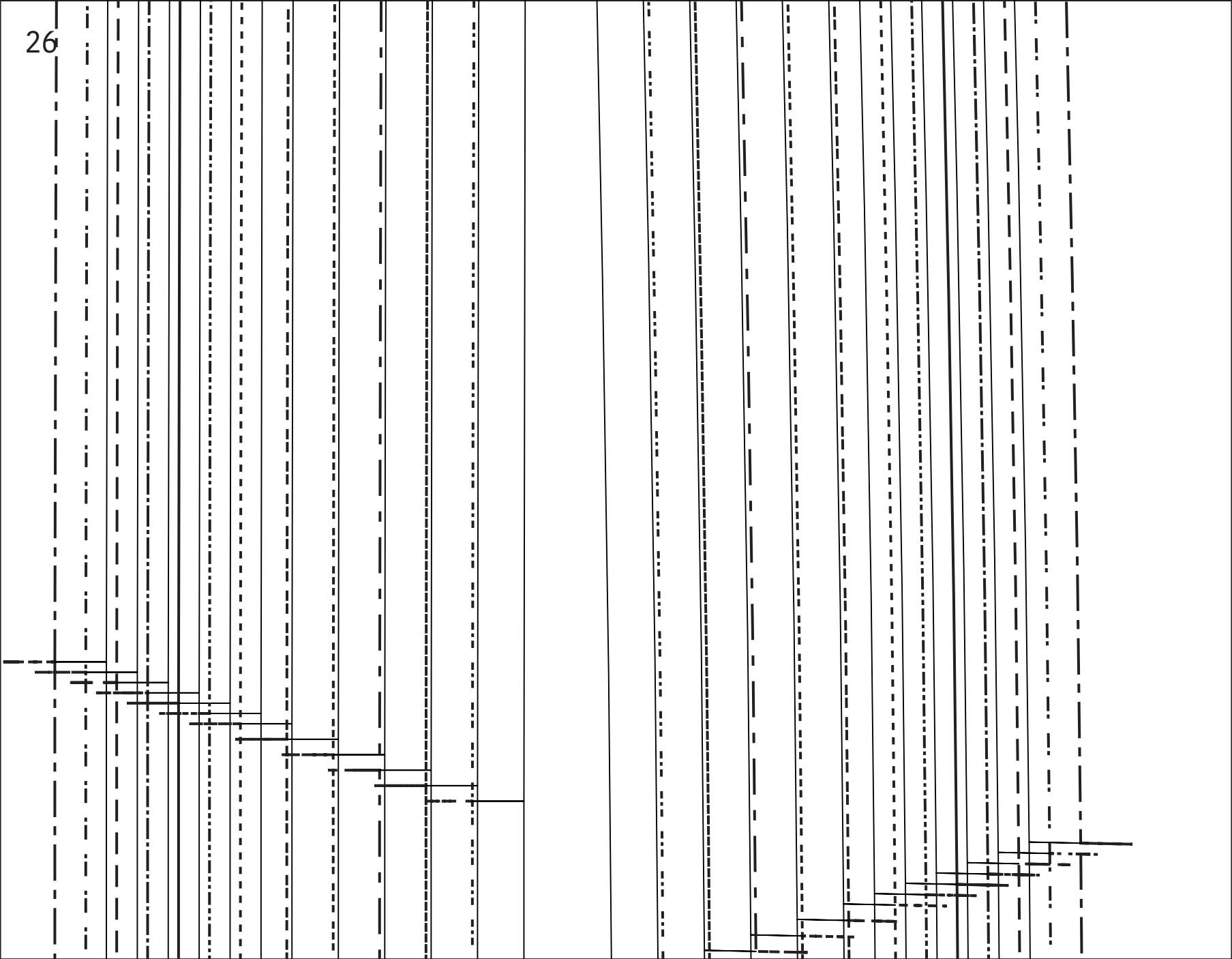

D

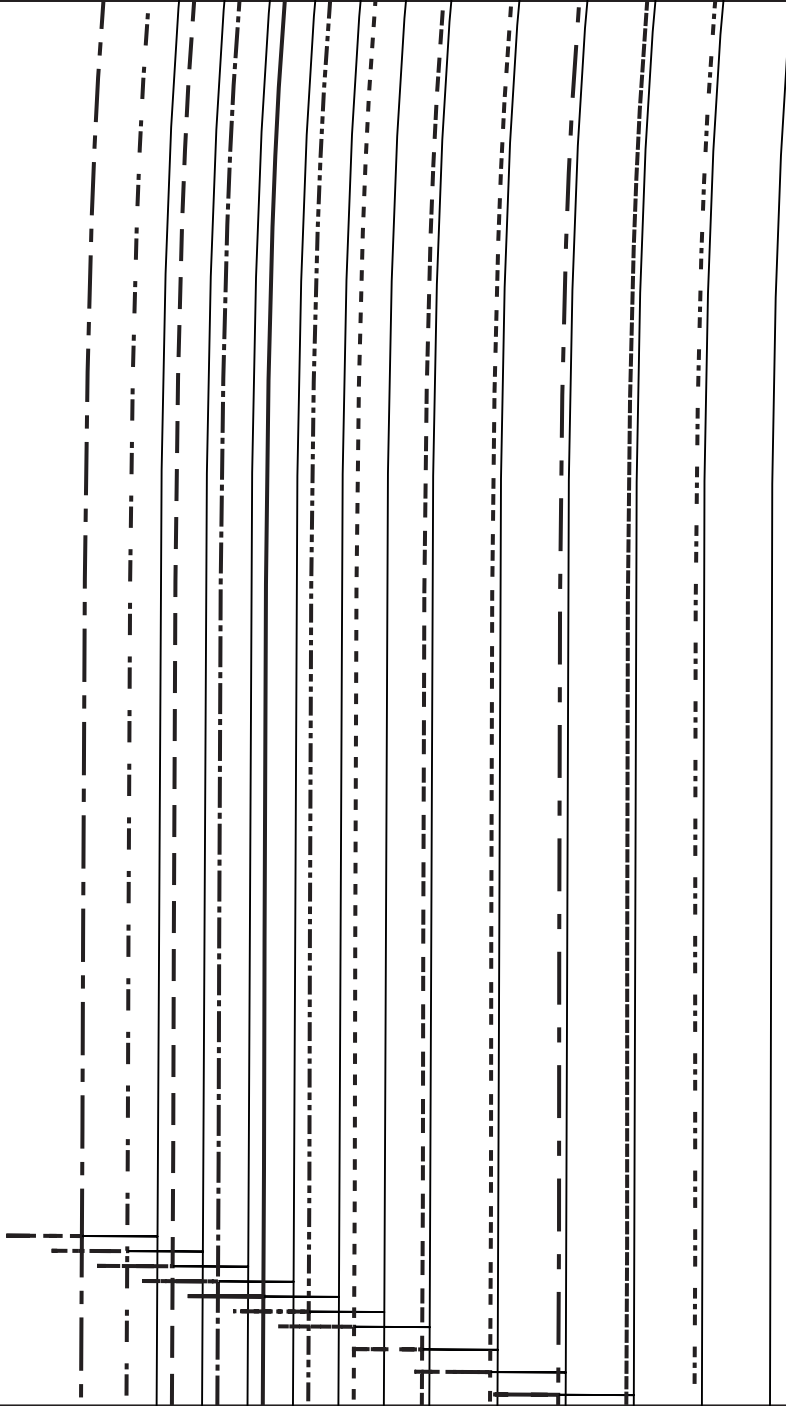

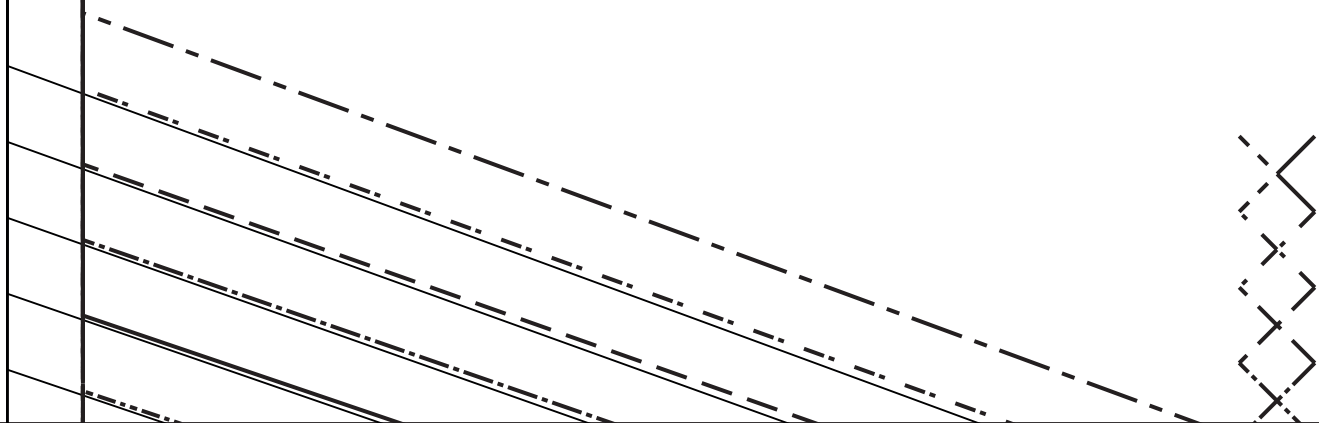

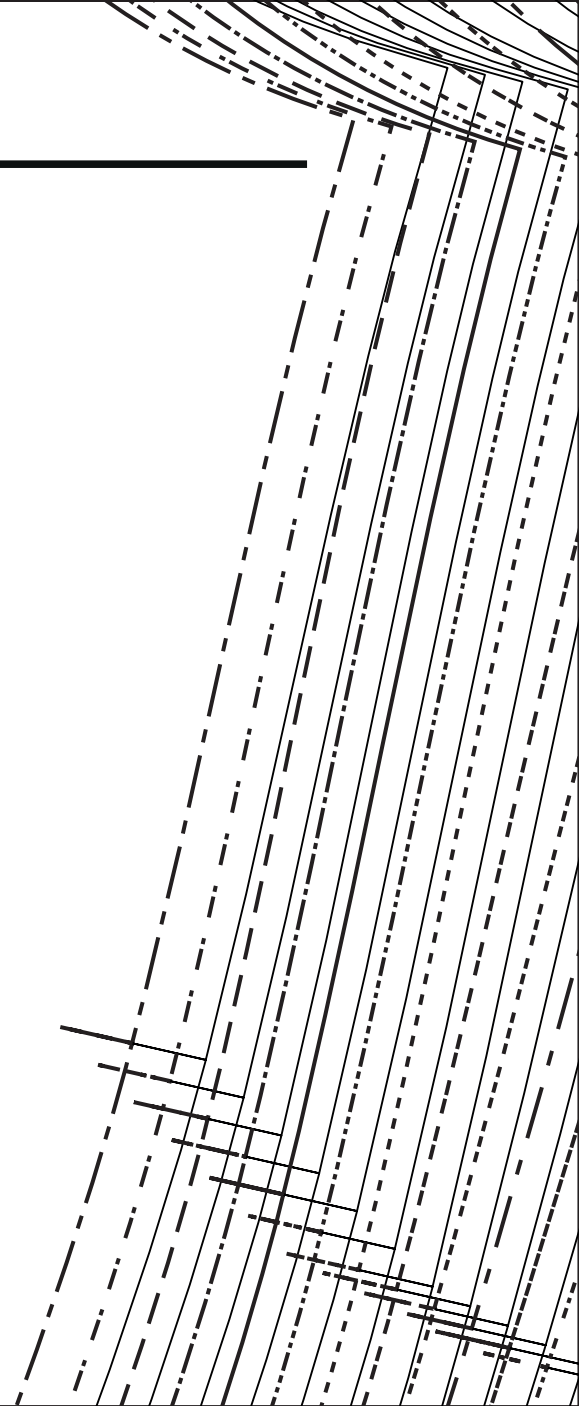

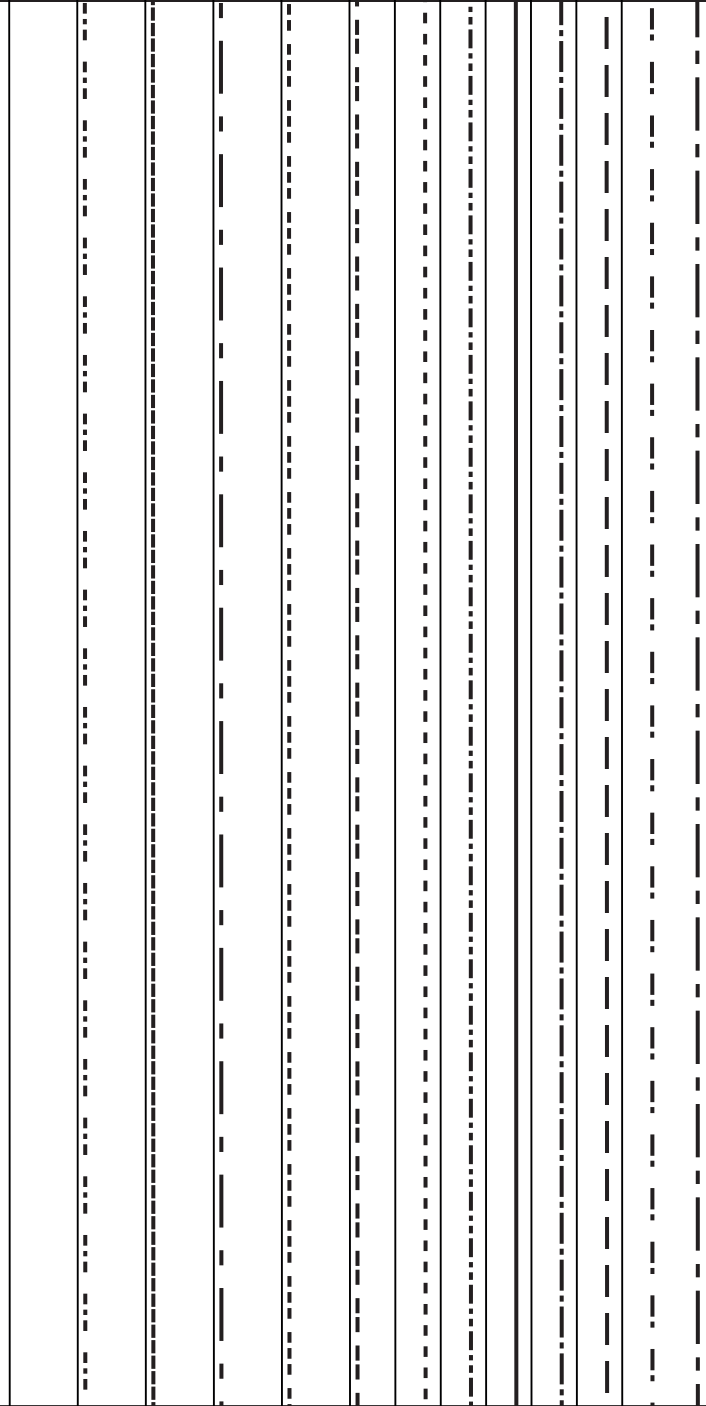
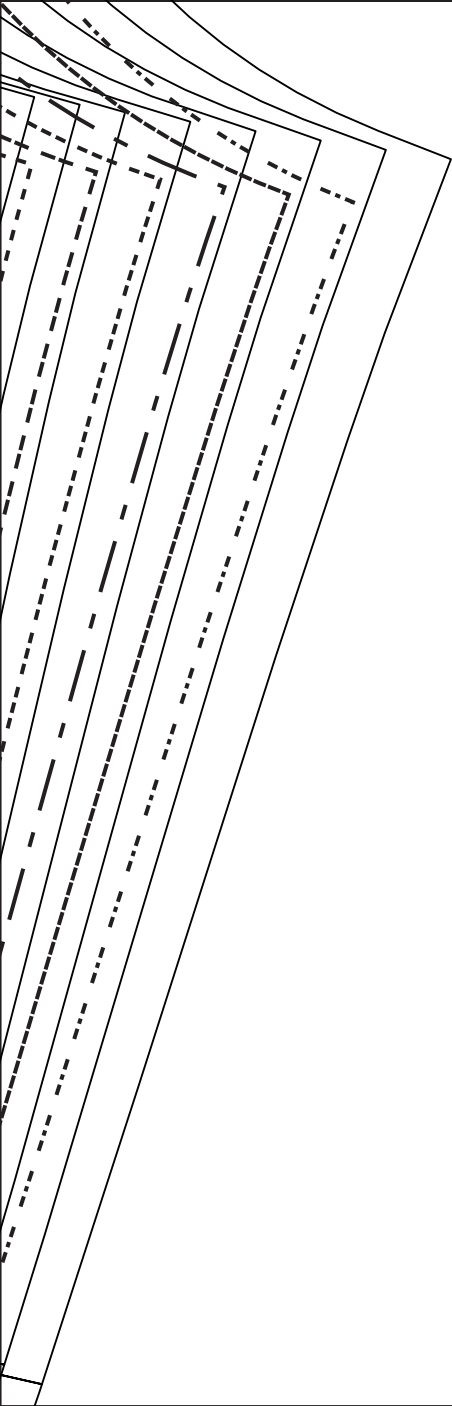





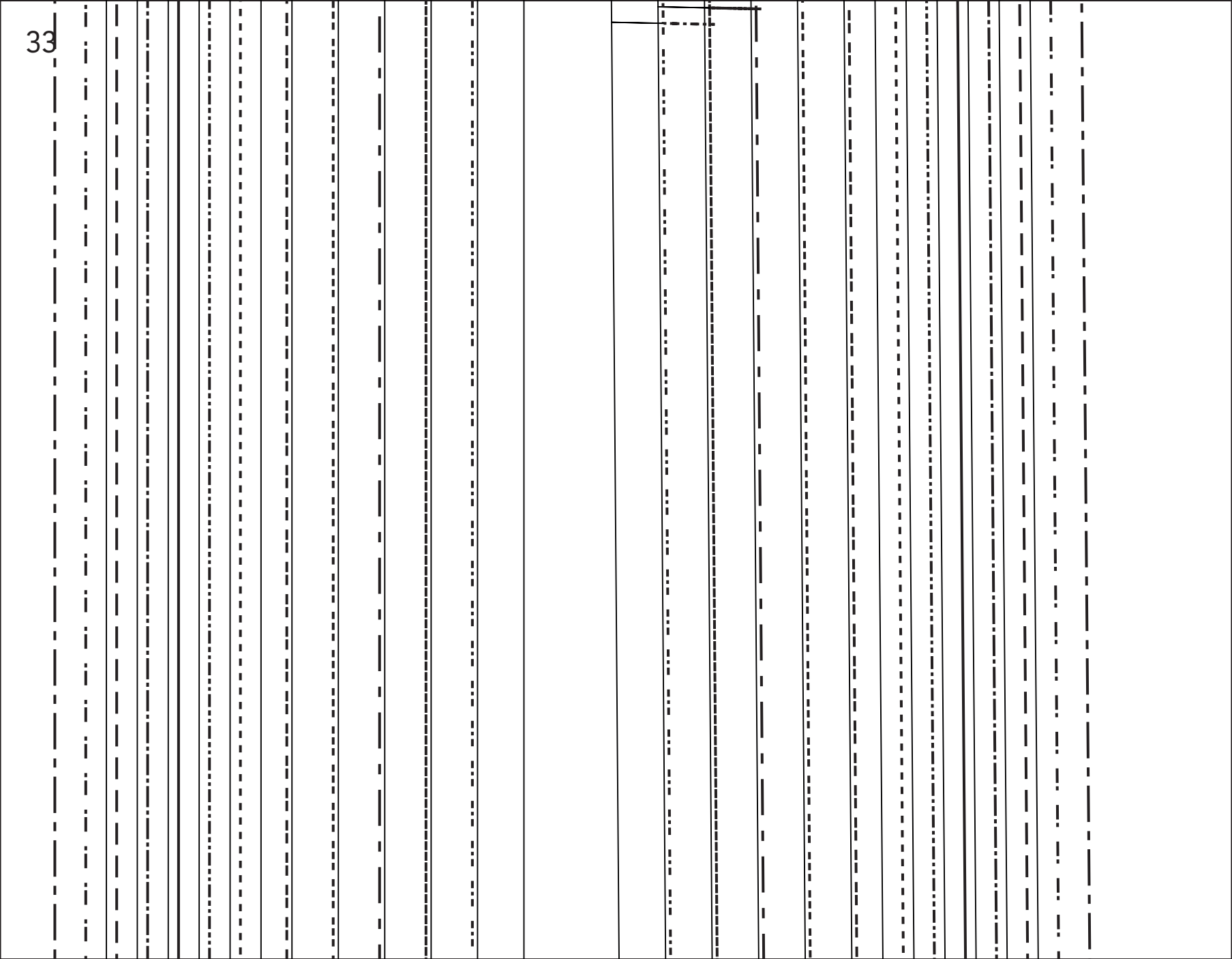



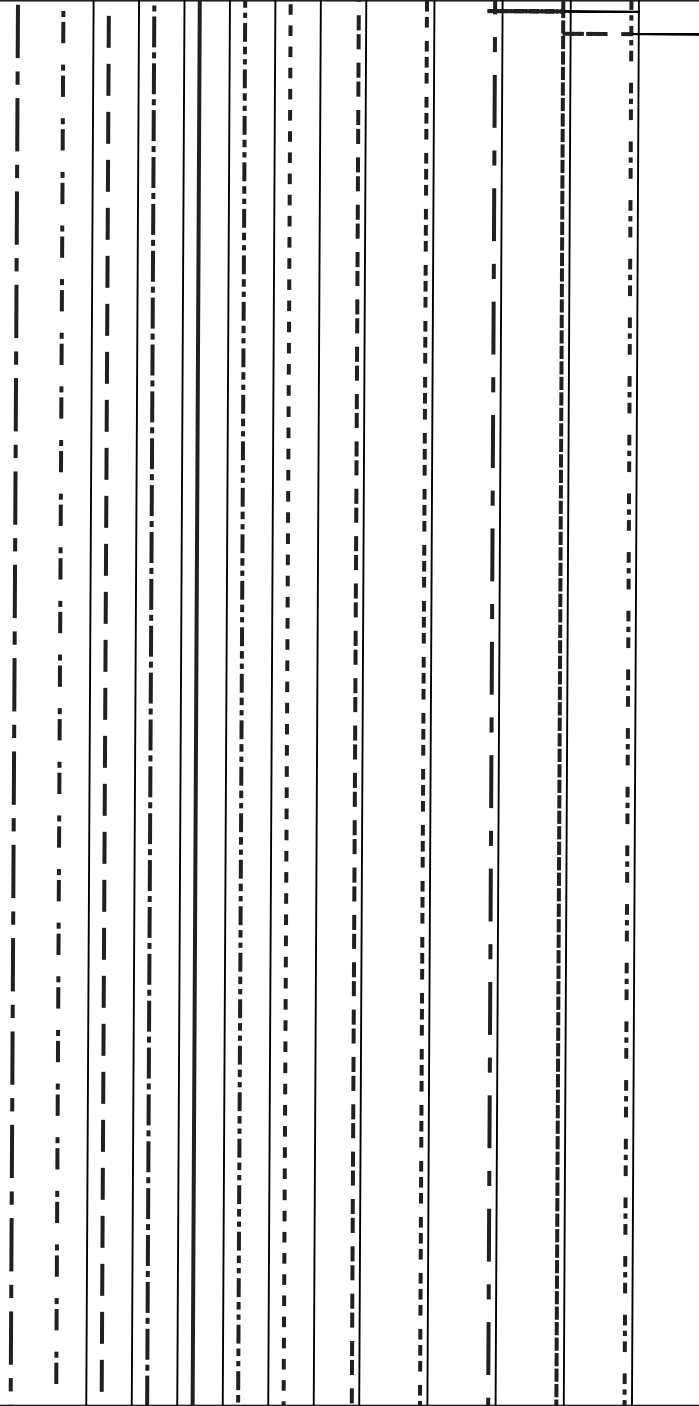

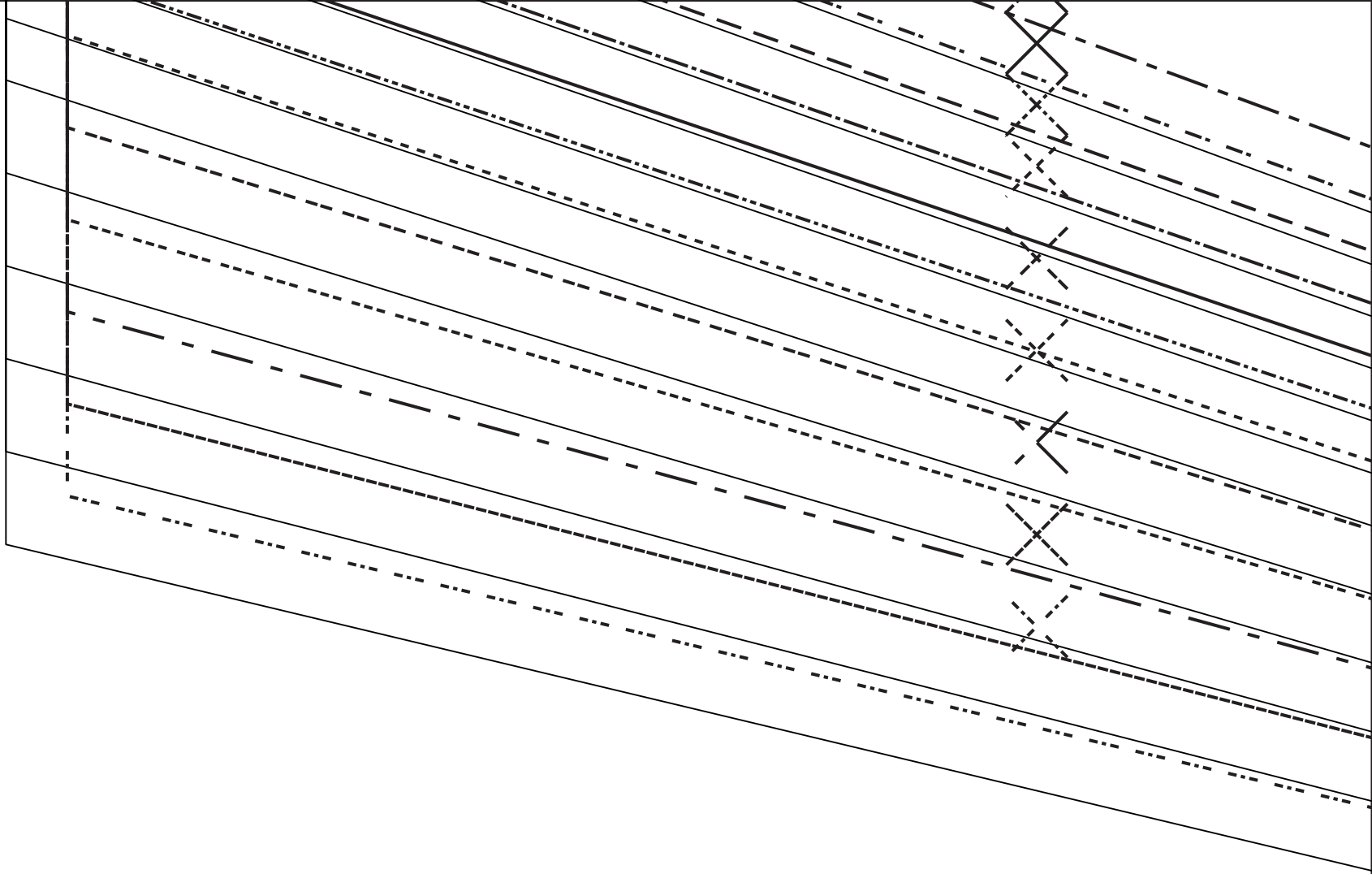

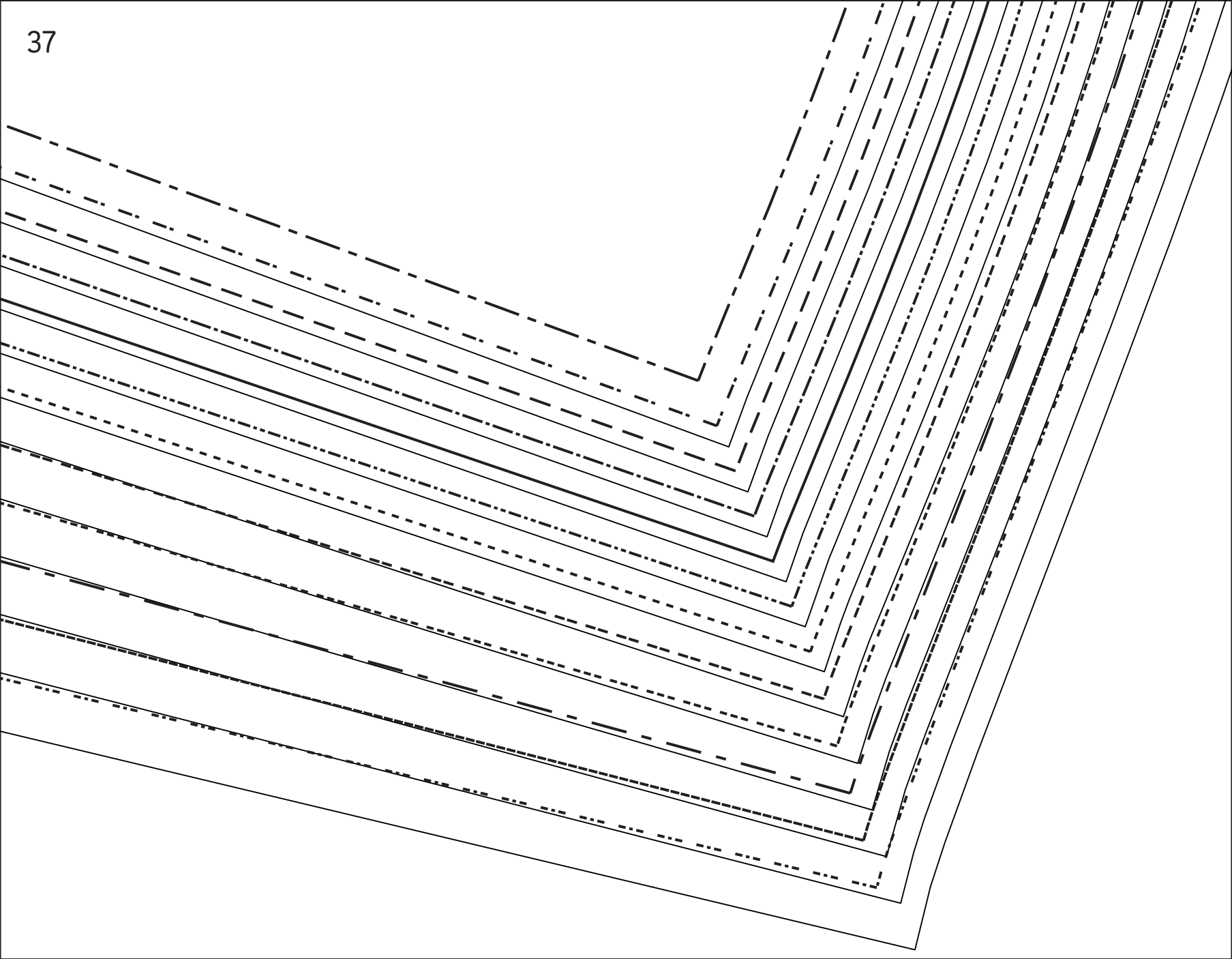





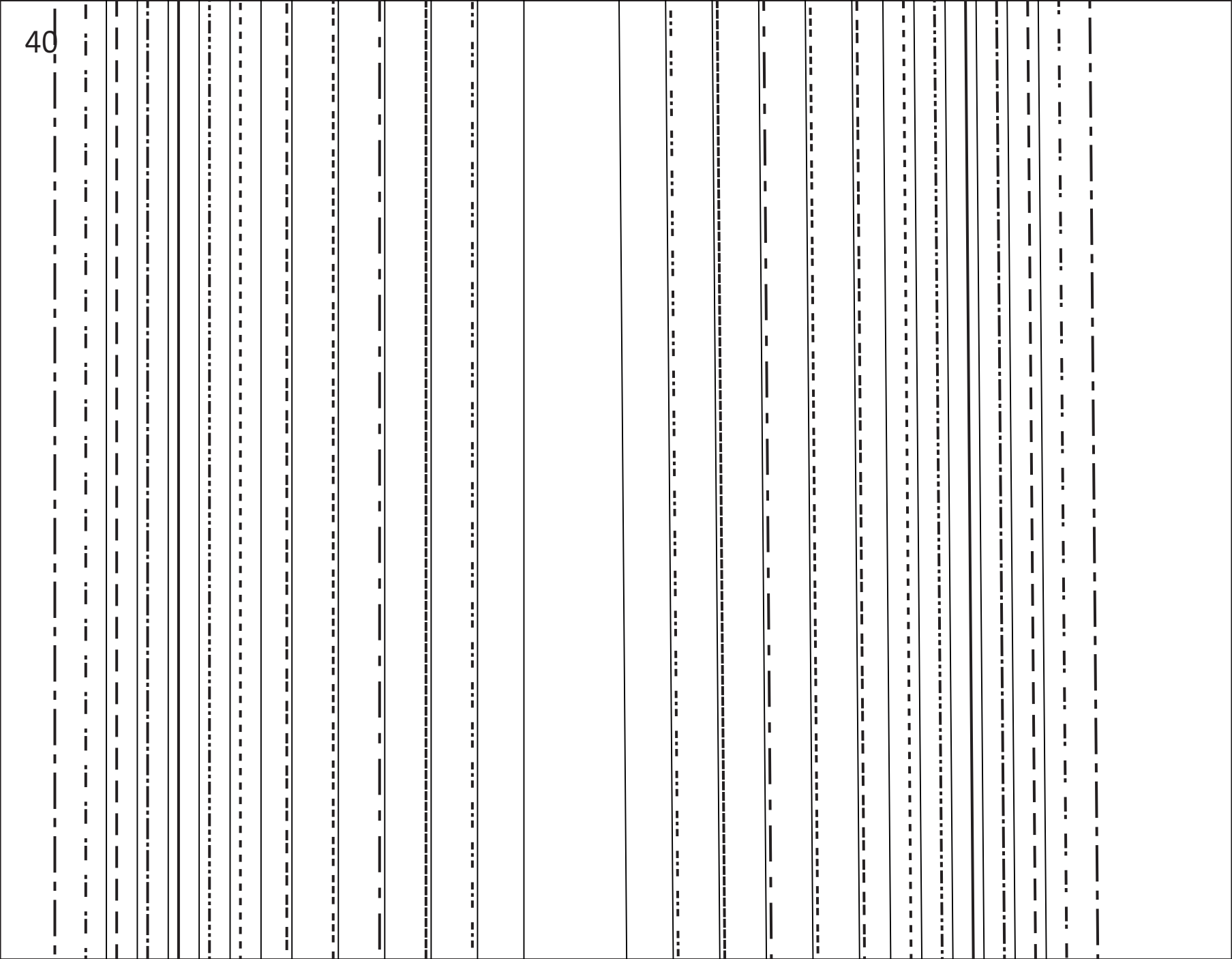





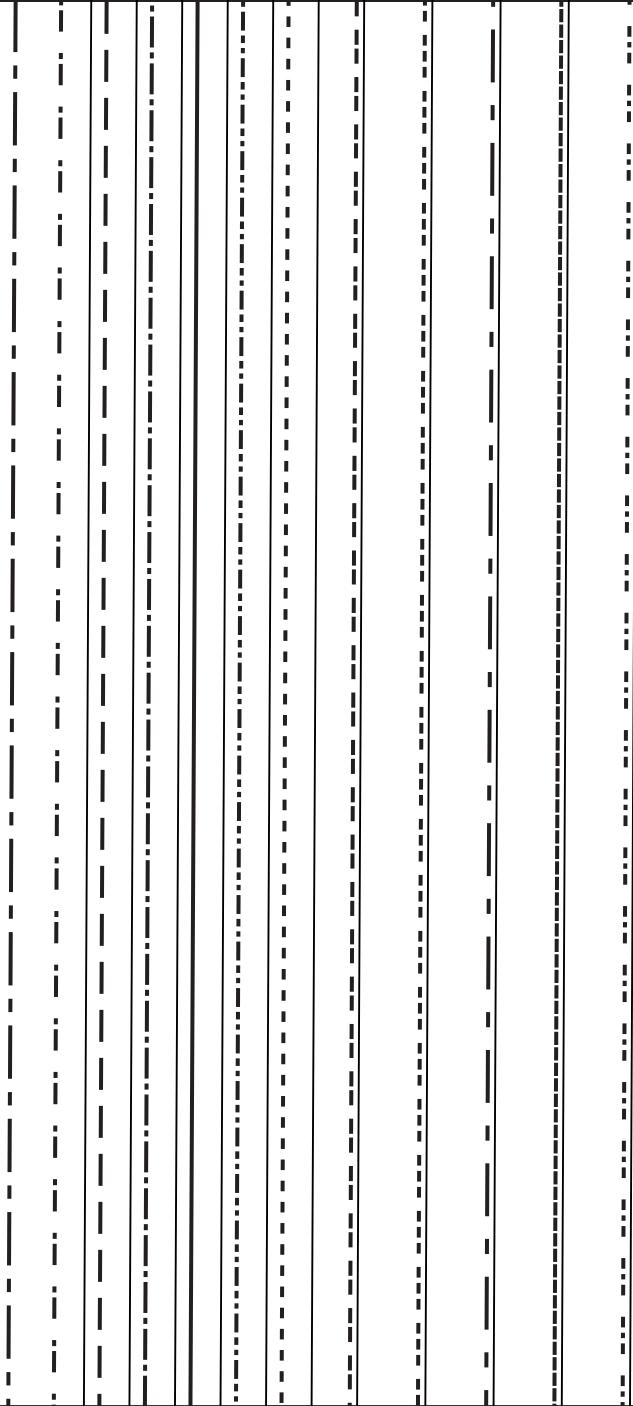





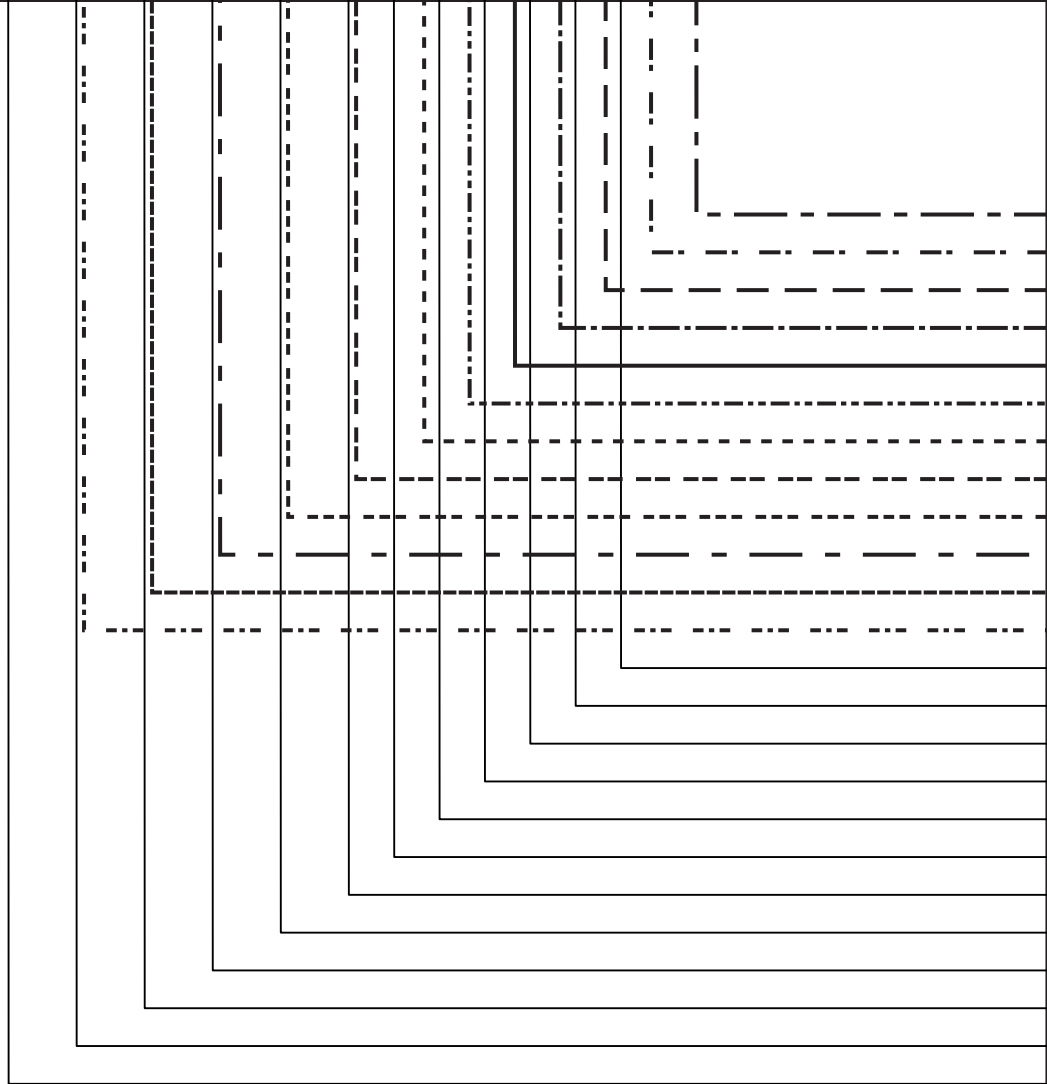

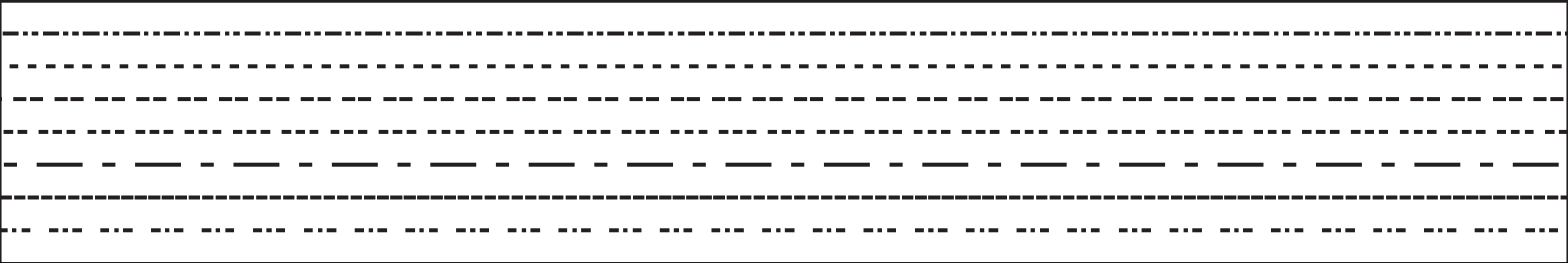

47,

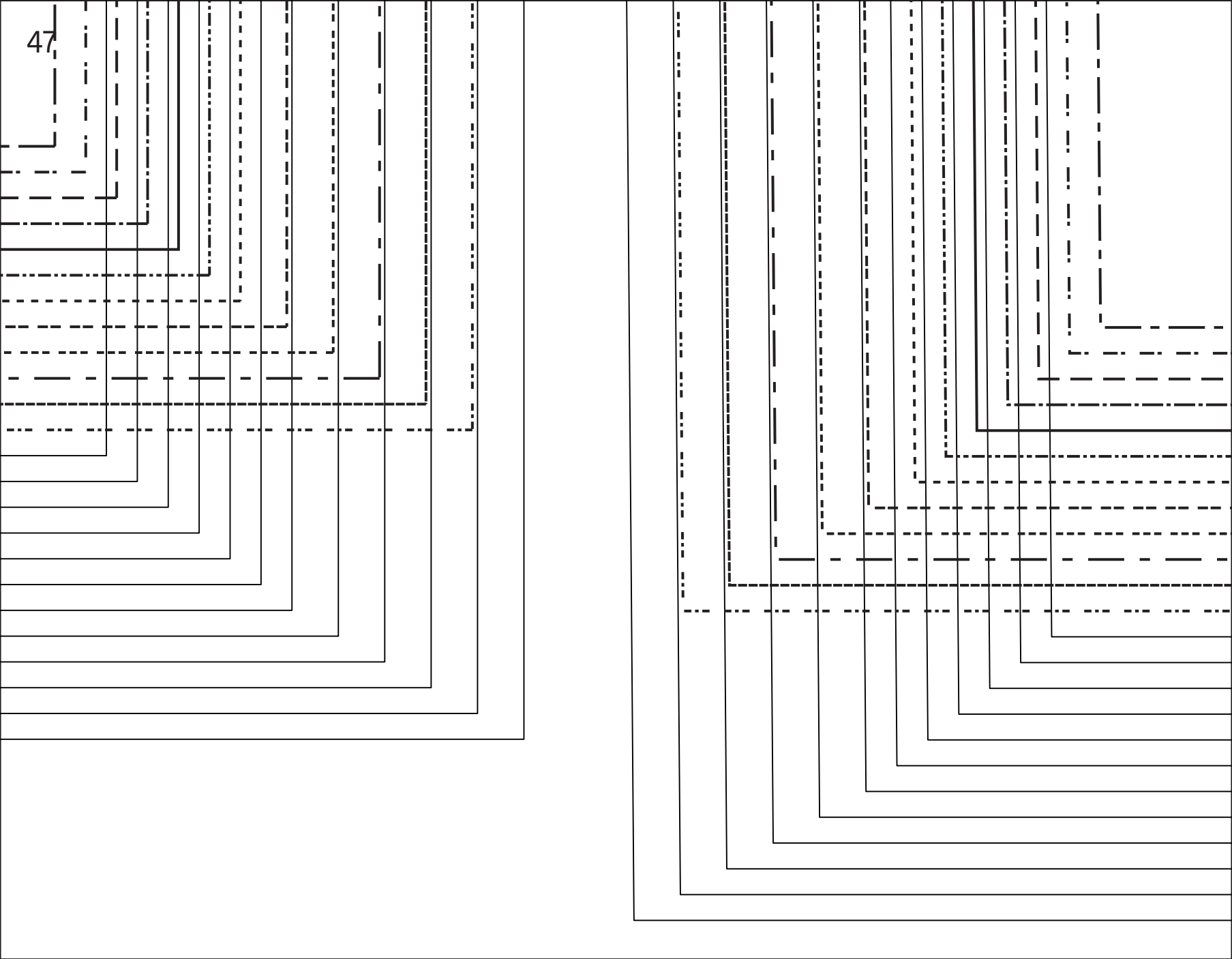



A series of horizontal lines for writing, consisting of a solid top line, a dashed midline, a solid baseline, and a dashed descender line, followed by several more solid lines.



