

Nick

Broek / Pantalon / Trousers / Hose

Maten / Tailles / Sizes / Größen:

.....	XXS
-----	XS
-----	S
- . - . - . - . - . - .	M
-----	L
-----	XL
-----	XXL
-----	XXXL

Patroondelen / Pièces du patron / Pattern pieces / Schnittteile:

- A** voorpand / devant / front panel /
Vorderteil
- B** rugpand / dos / back panel /
Rückenteil
- C** tailleband / ceinture / waistband /
Bund
- D** zijzak / poche / side pocket /
seitliche Tasche
- E** inkijk zijzak / ouverture poche /
outer pocket / Tascheneingriff
- F** bies / liseré poche dos / trim / Paspel
- G** inkijk bies / liseré ouverture poche
dos / outer pocket trim /
Paspel Tascheneingriff
- H** lint / ruban / ribbon / Band

Patroonschema / Schéma du Patron / Pattern Diagram / Übersichtsplan zum Zusammenkleben

1	2	3	4	5	6
7	8	9	10	11	12
13	14	15	16	17	18
19	20	21	22	23	24
25					

Controlevierkant / Carré de controle / Test square / Kontrollquadrat

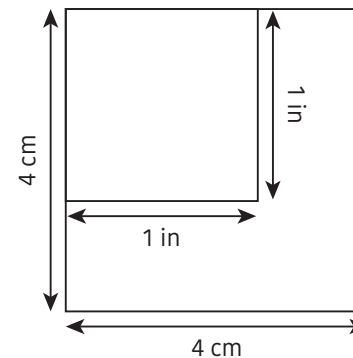

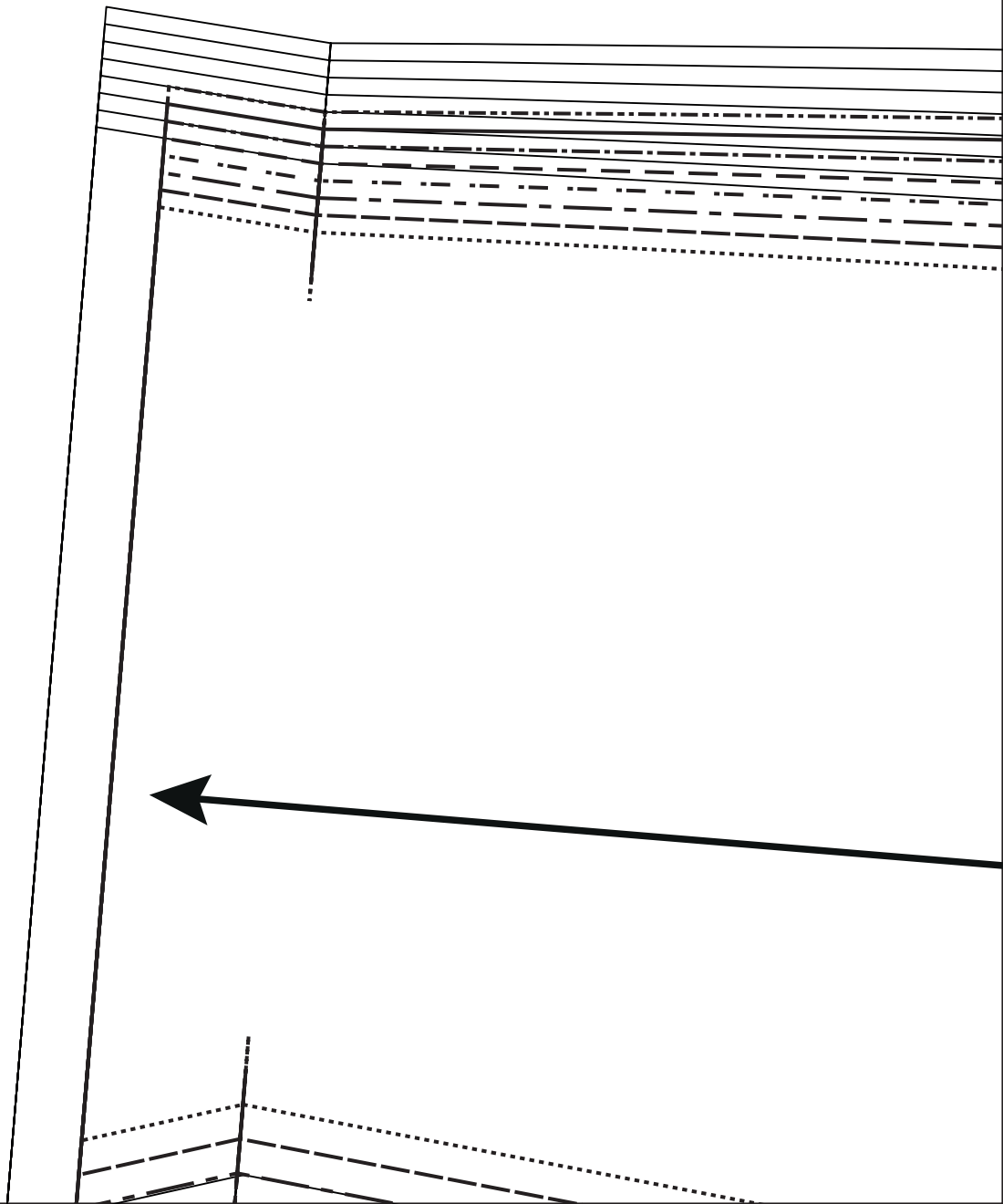

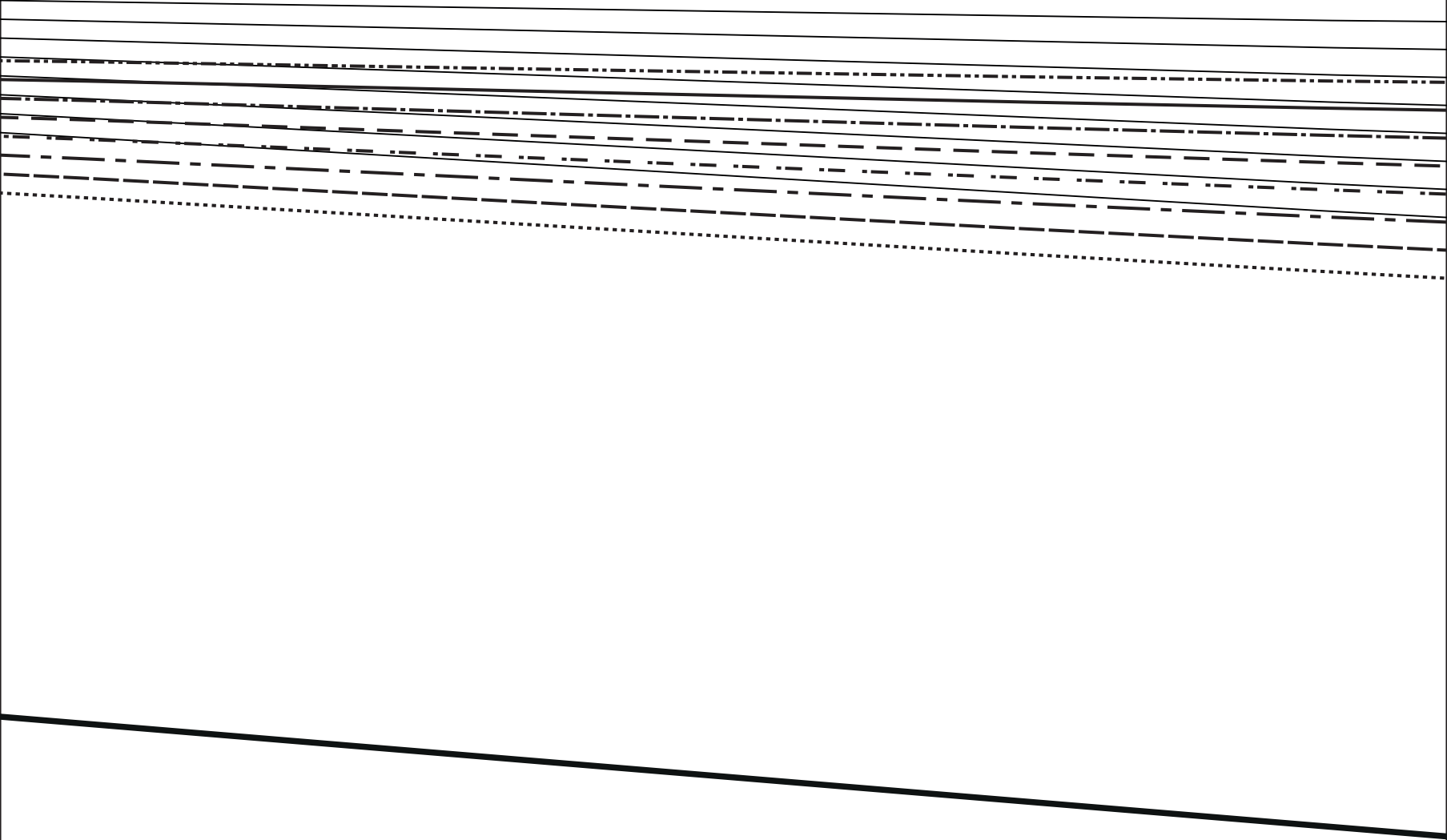

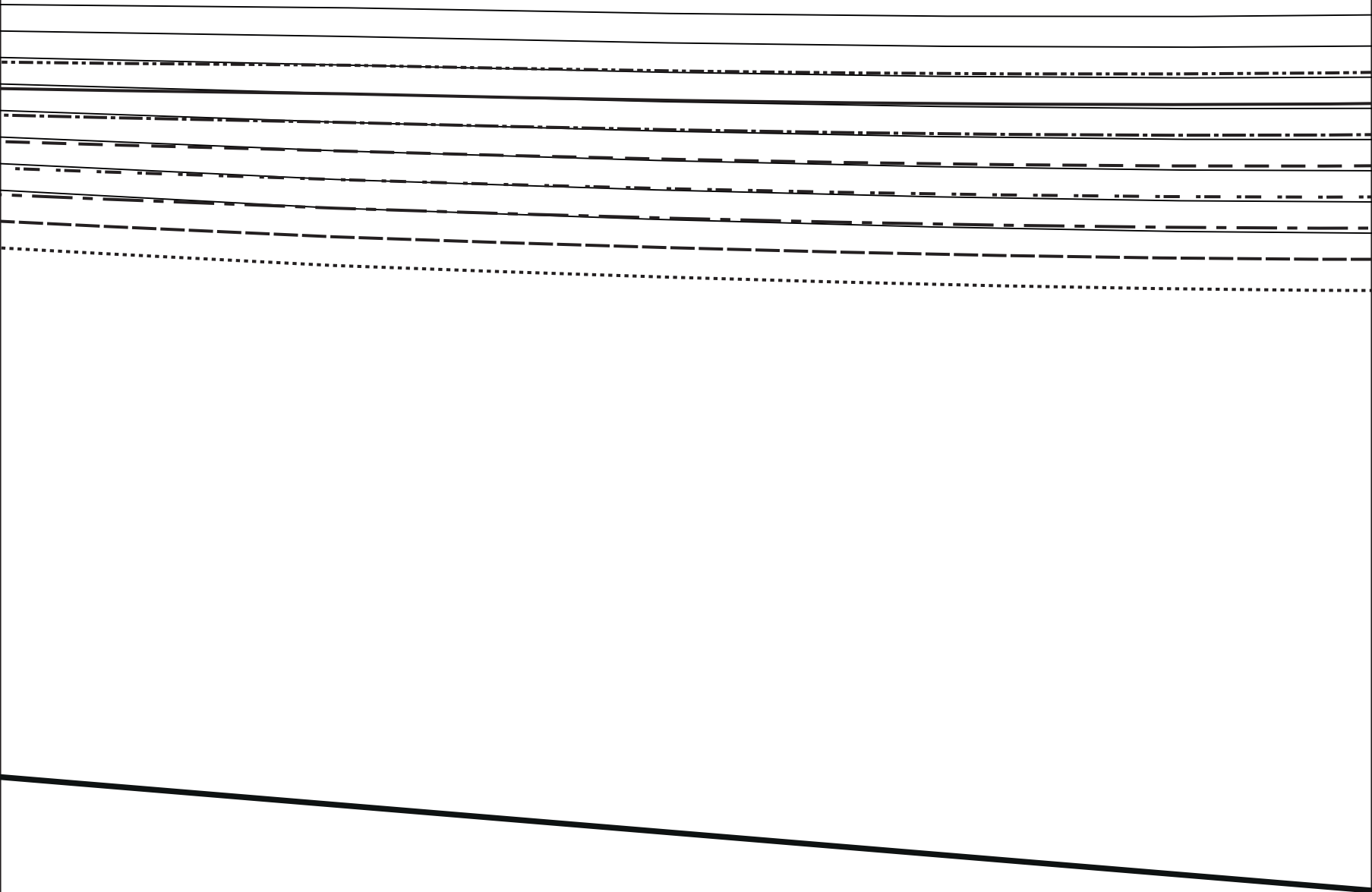

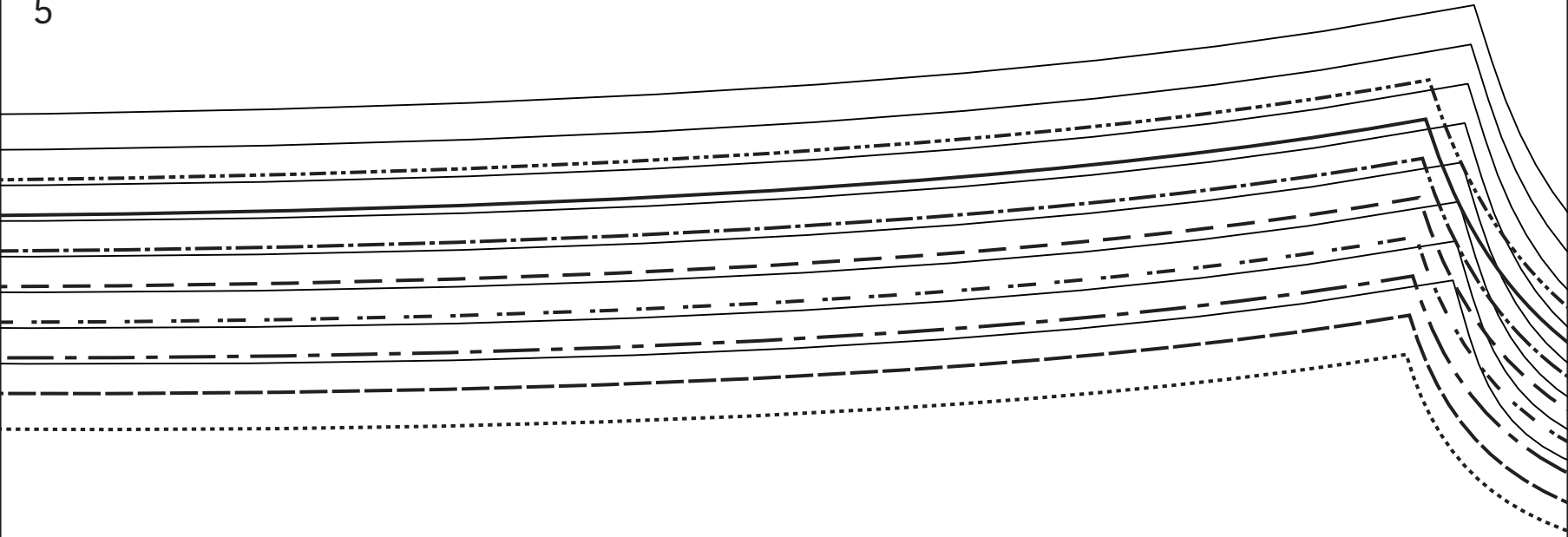

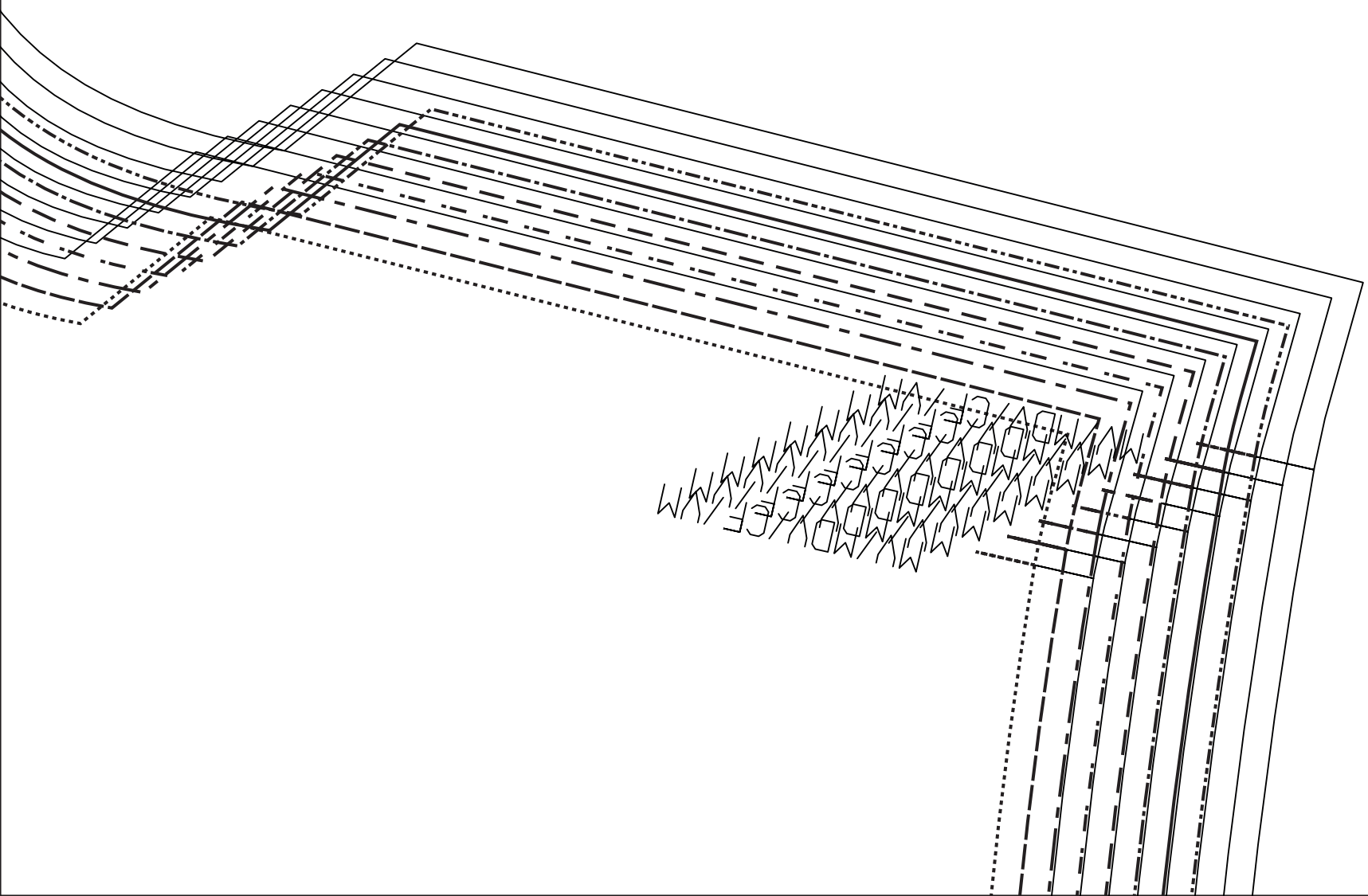

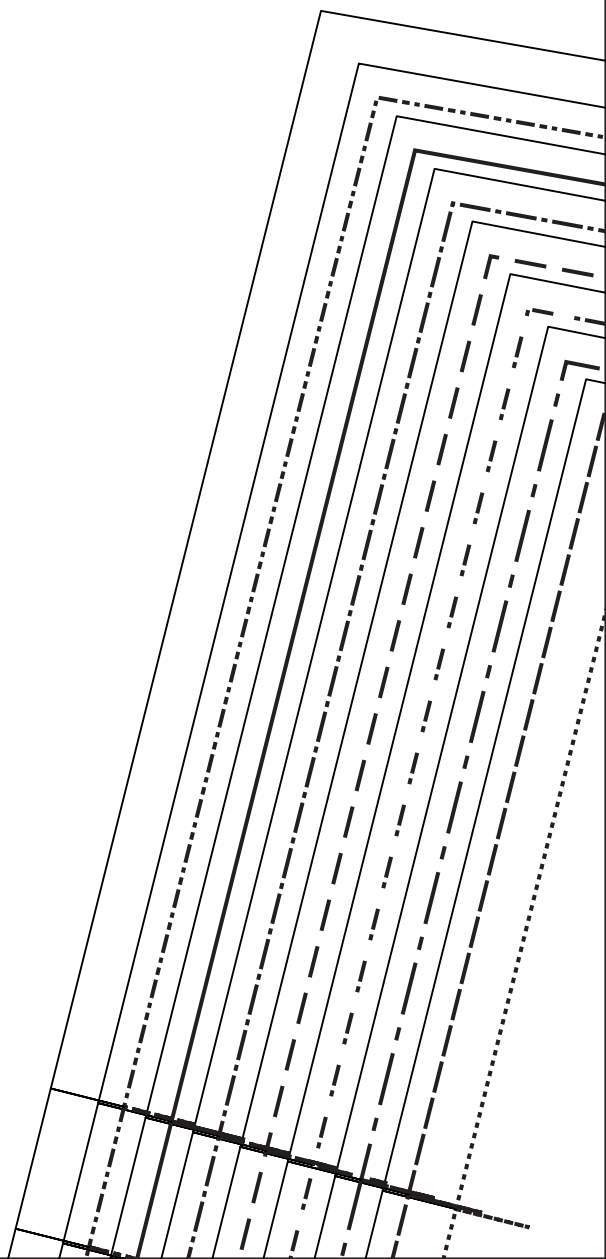
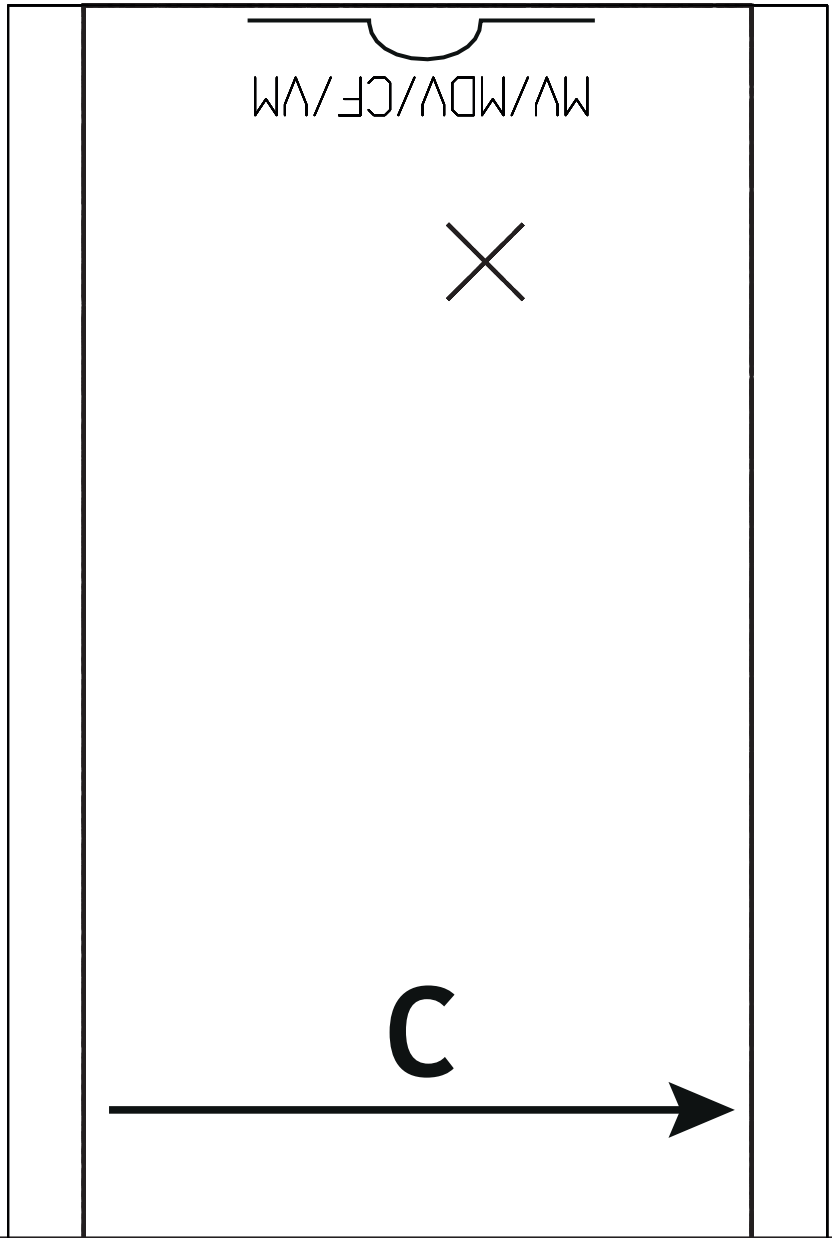

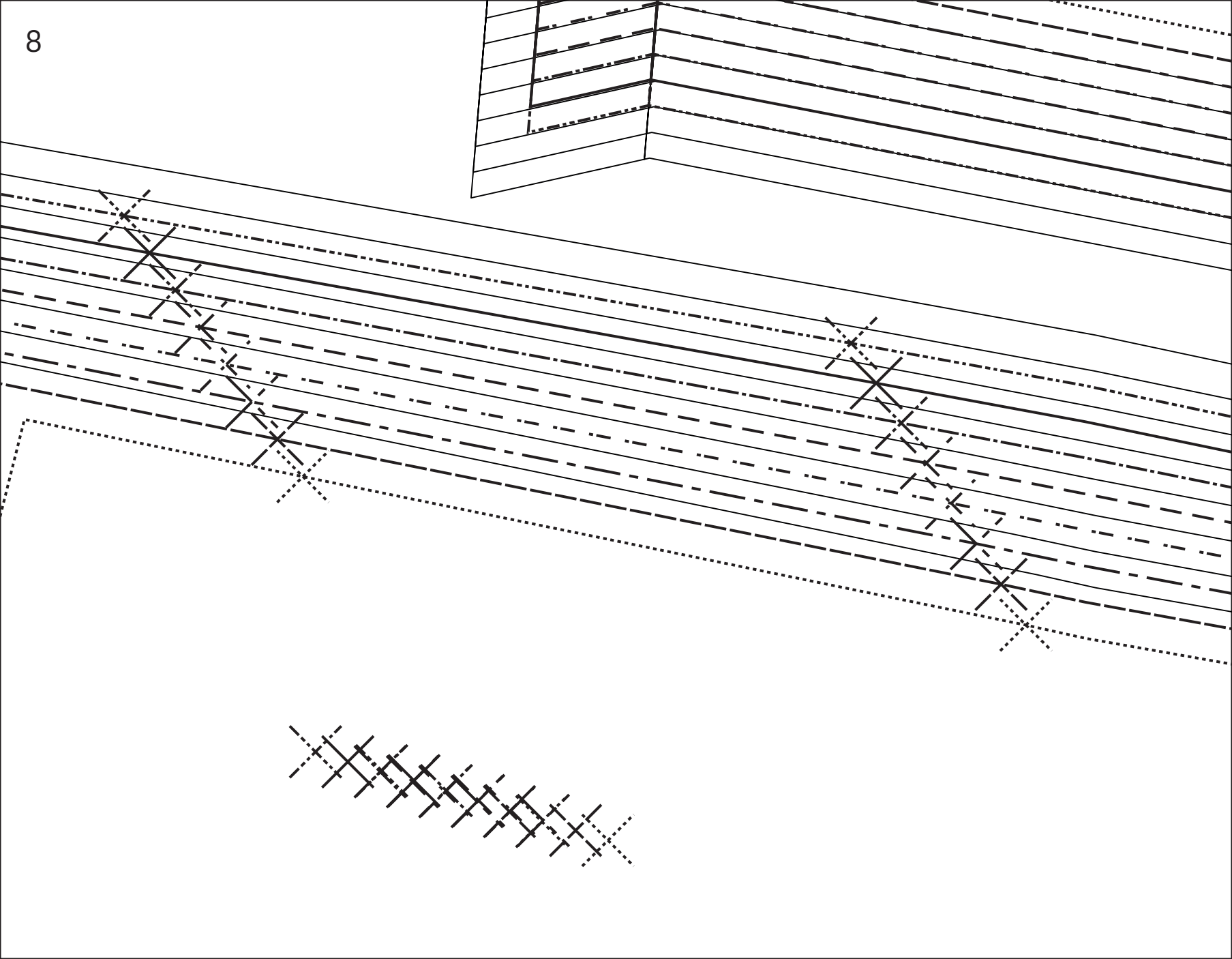

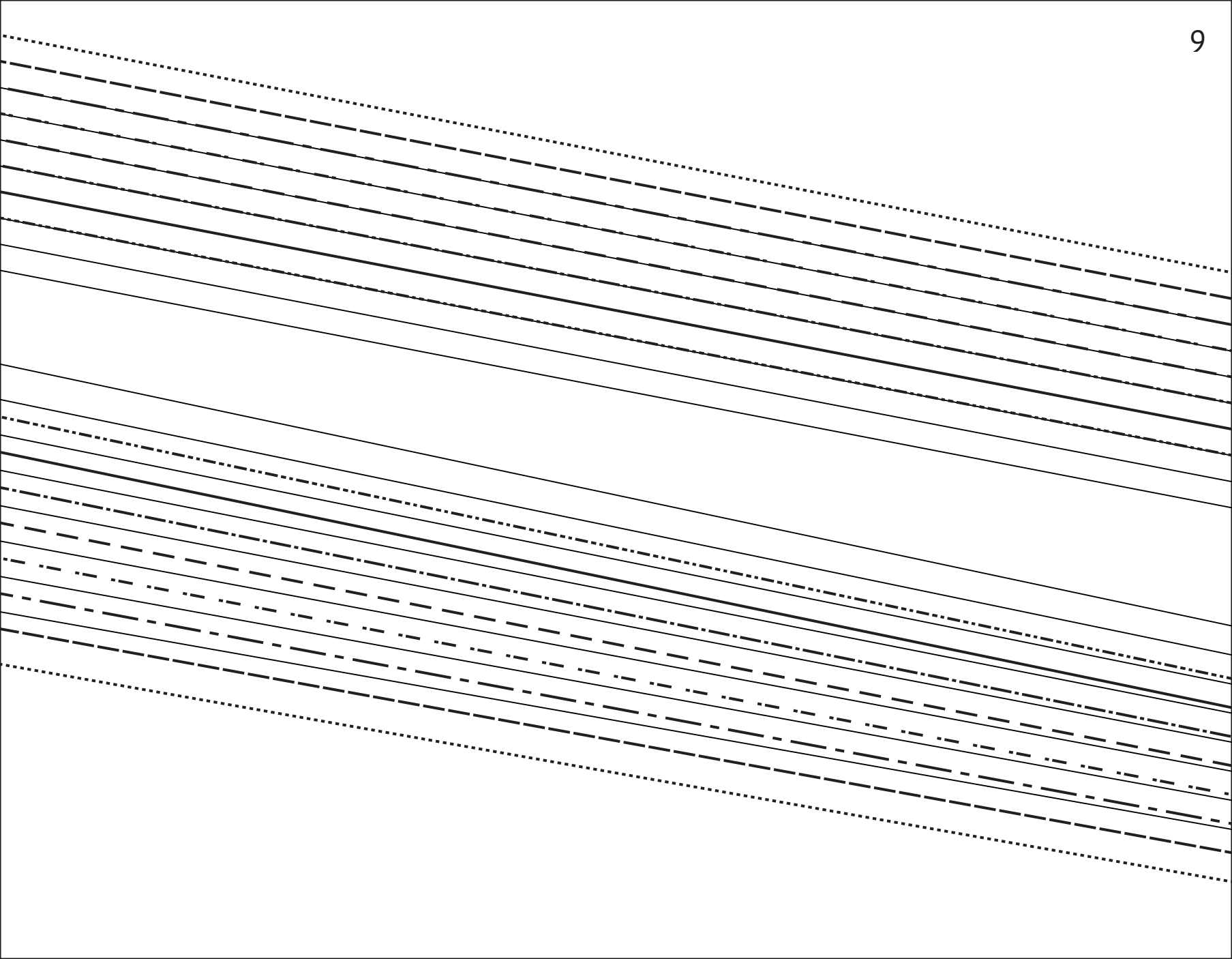

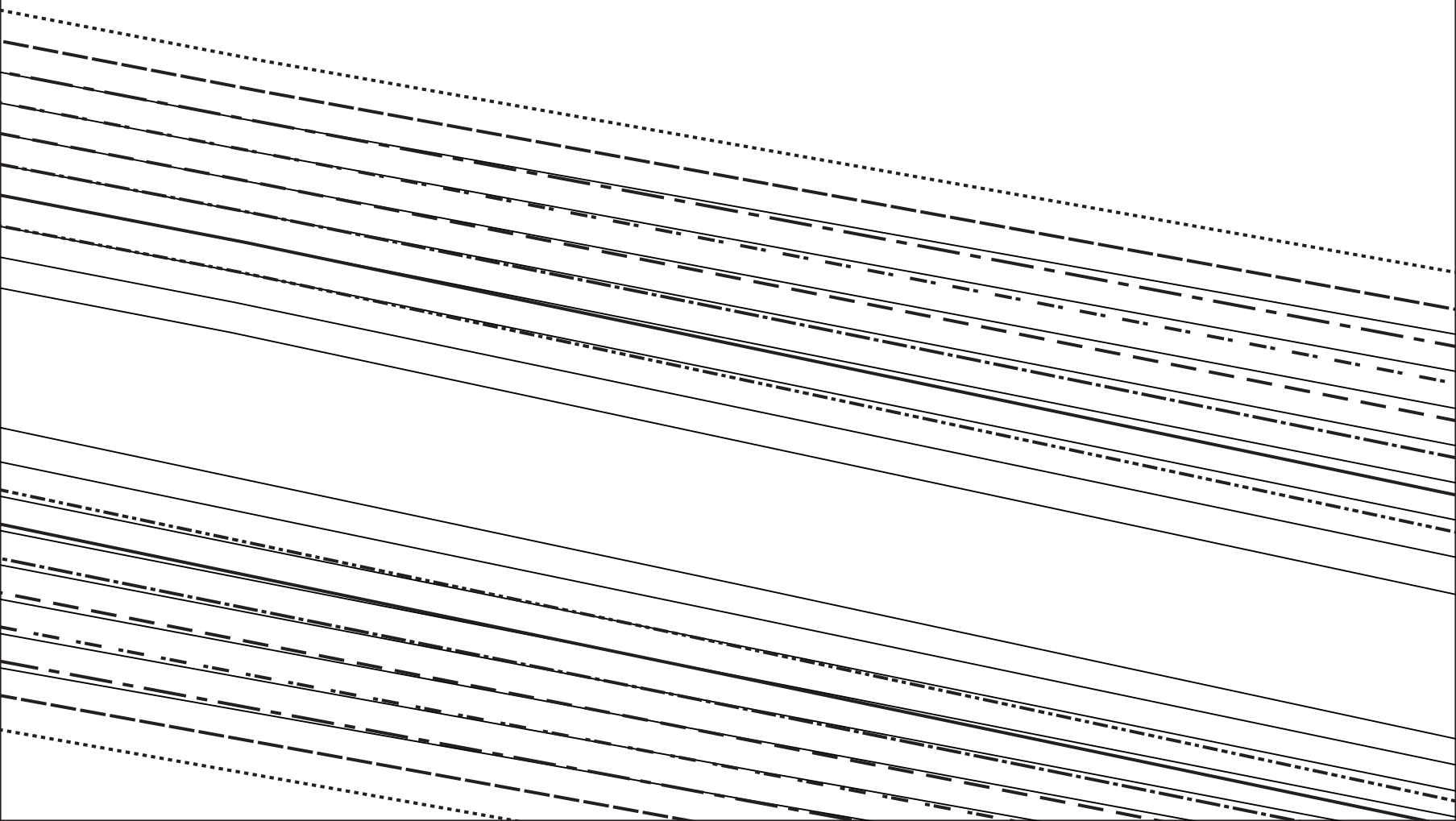

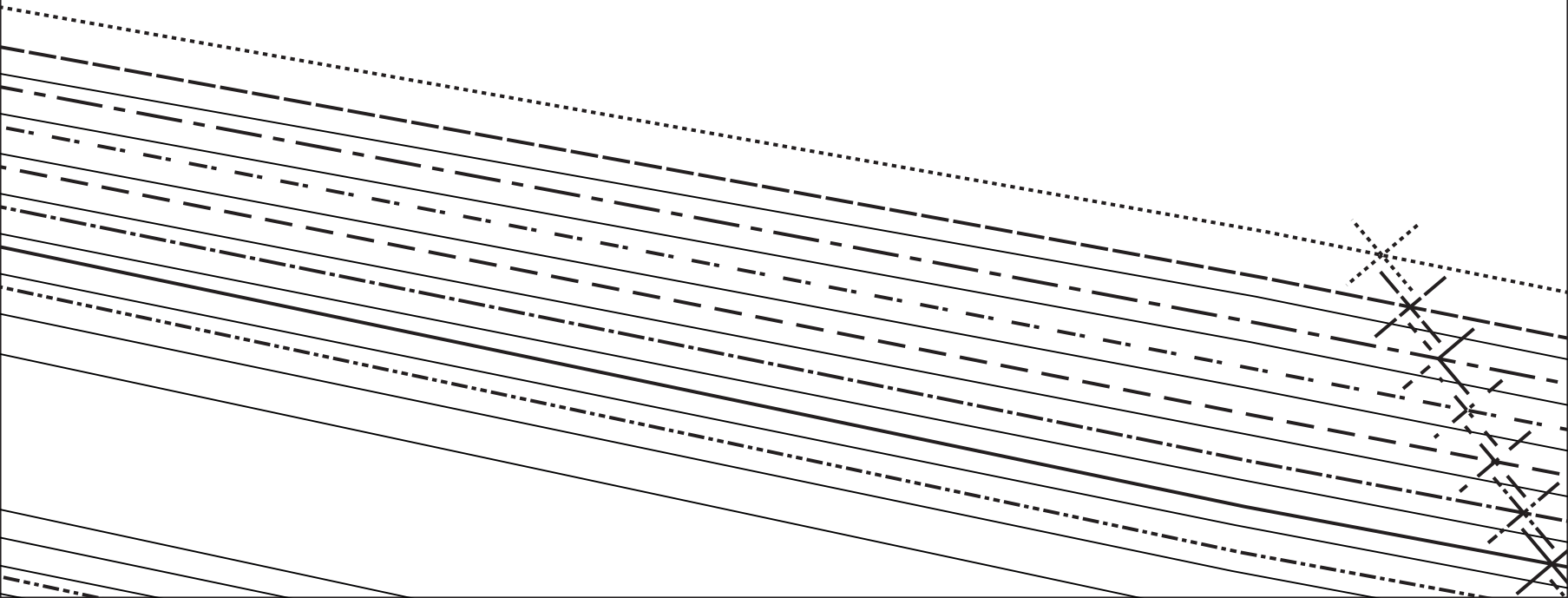

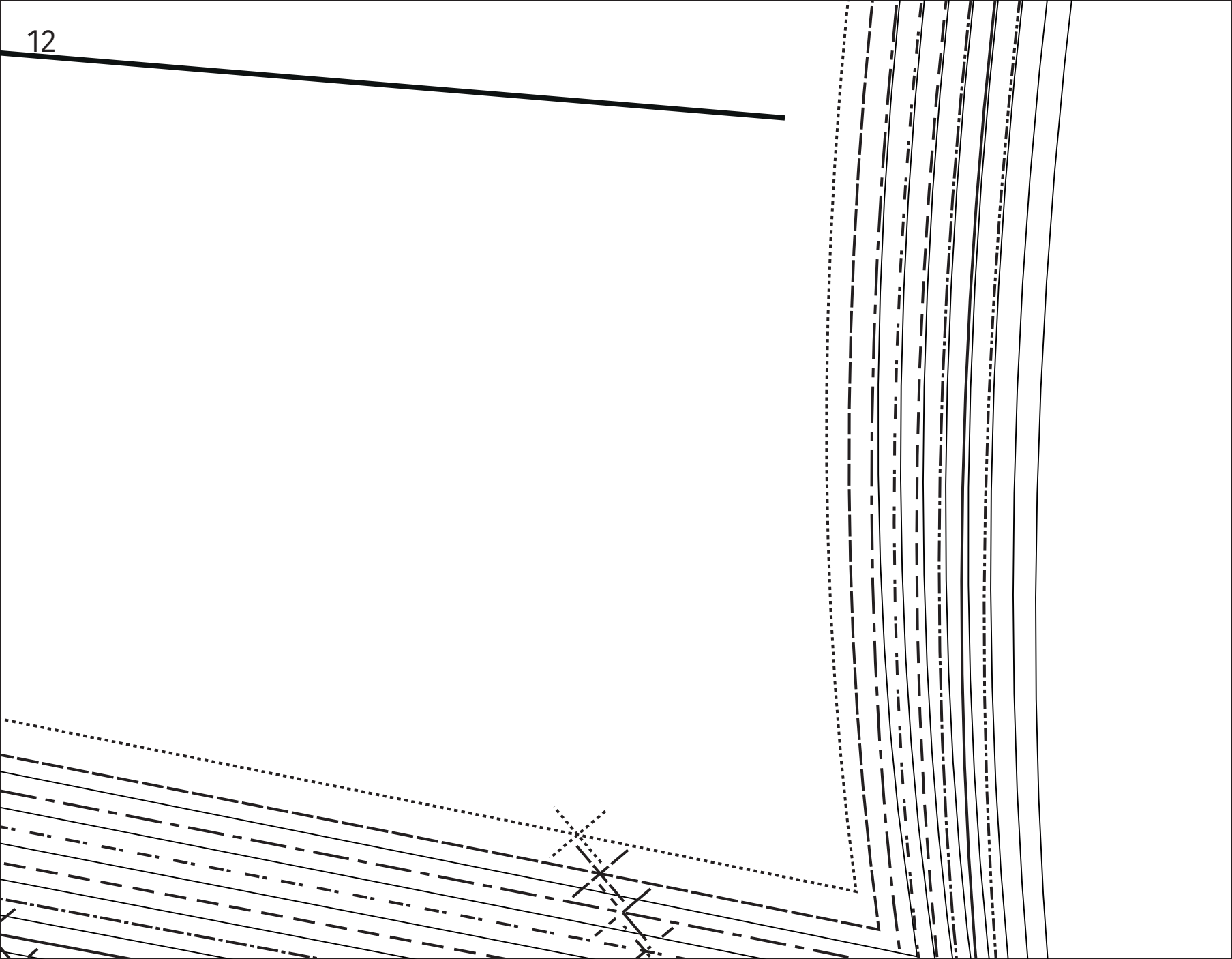

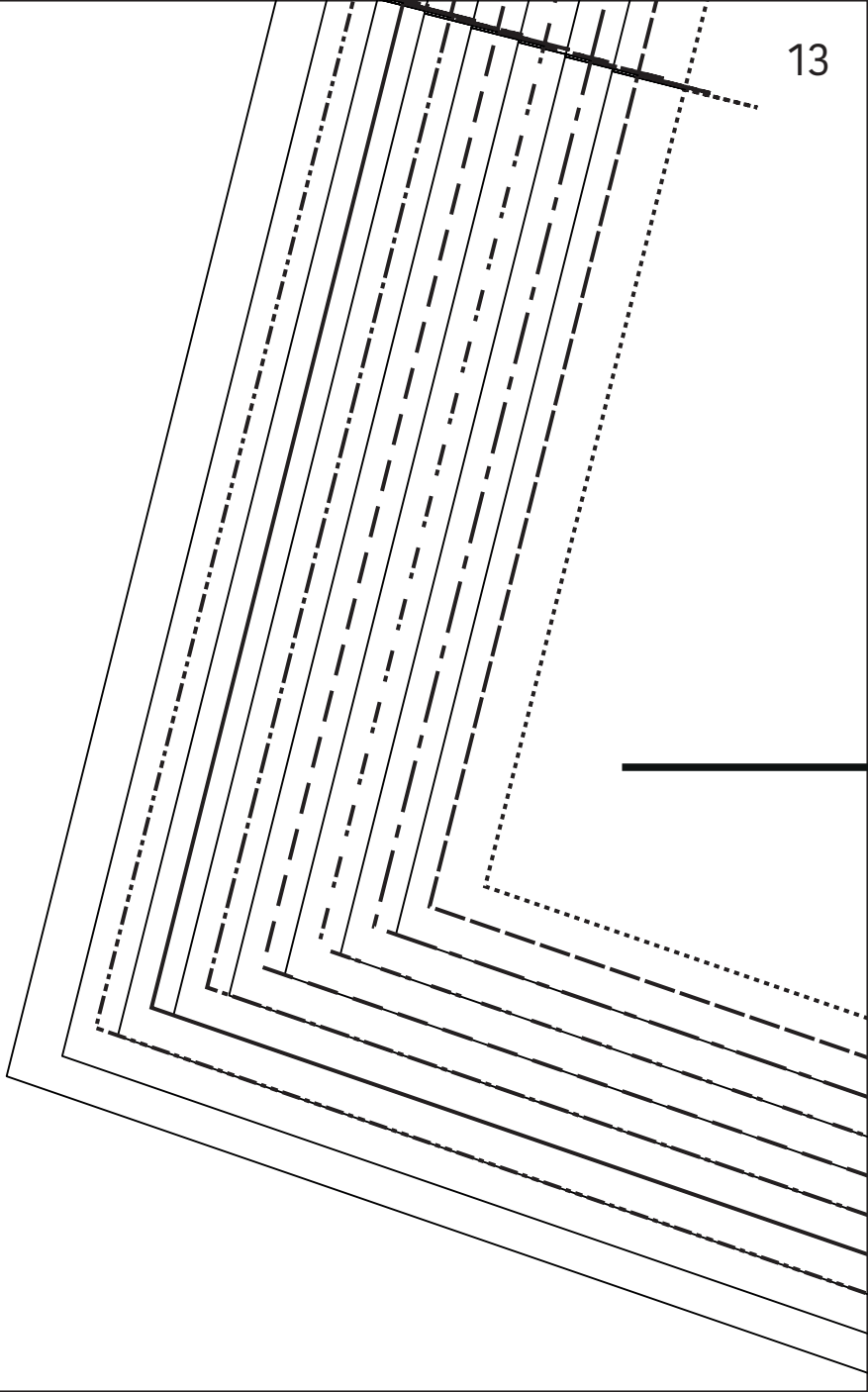
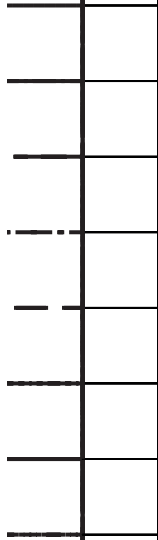
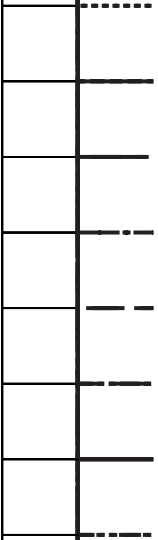

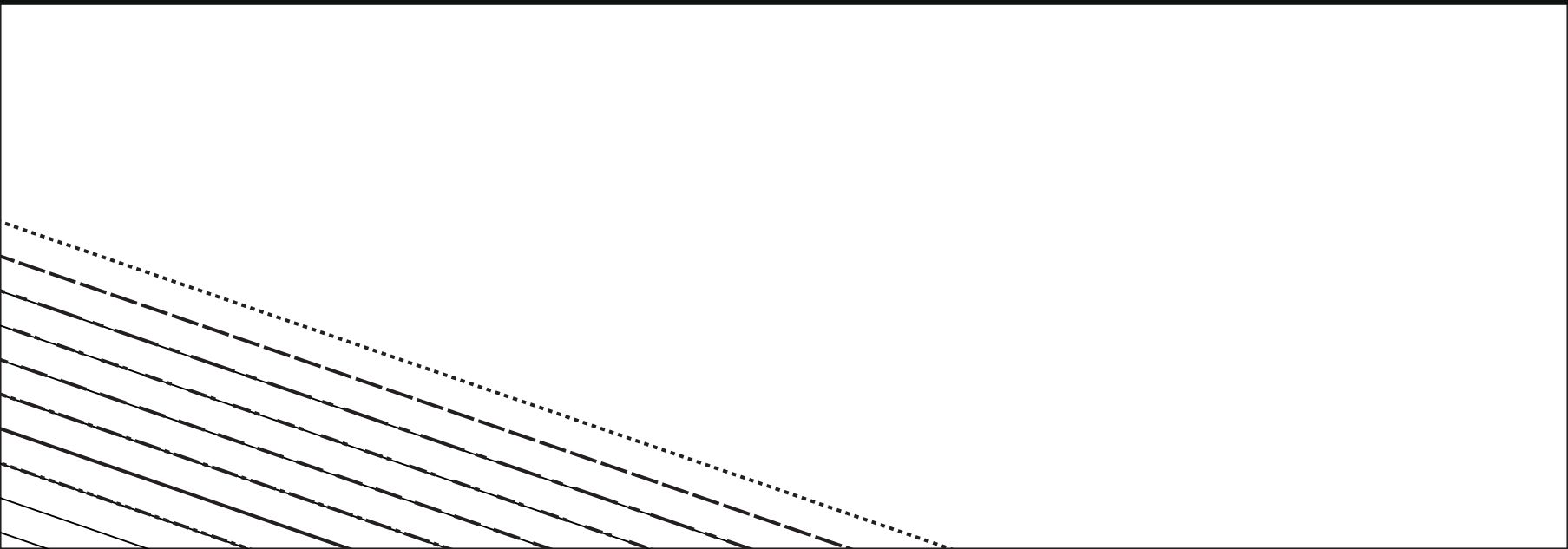
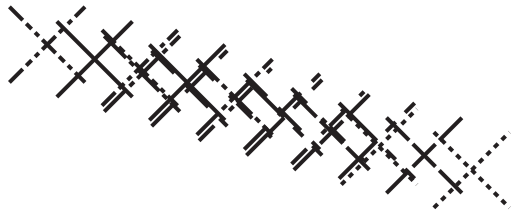
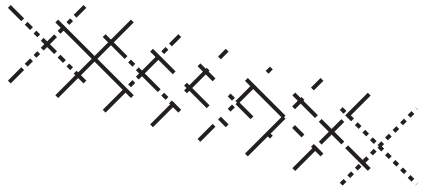

B

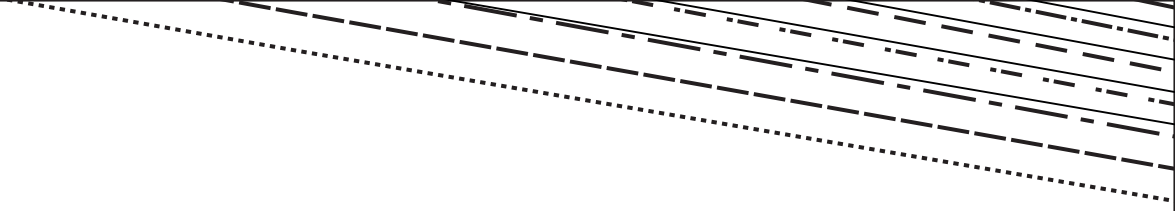

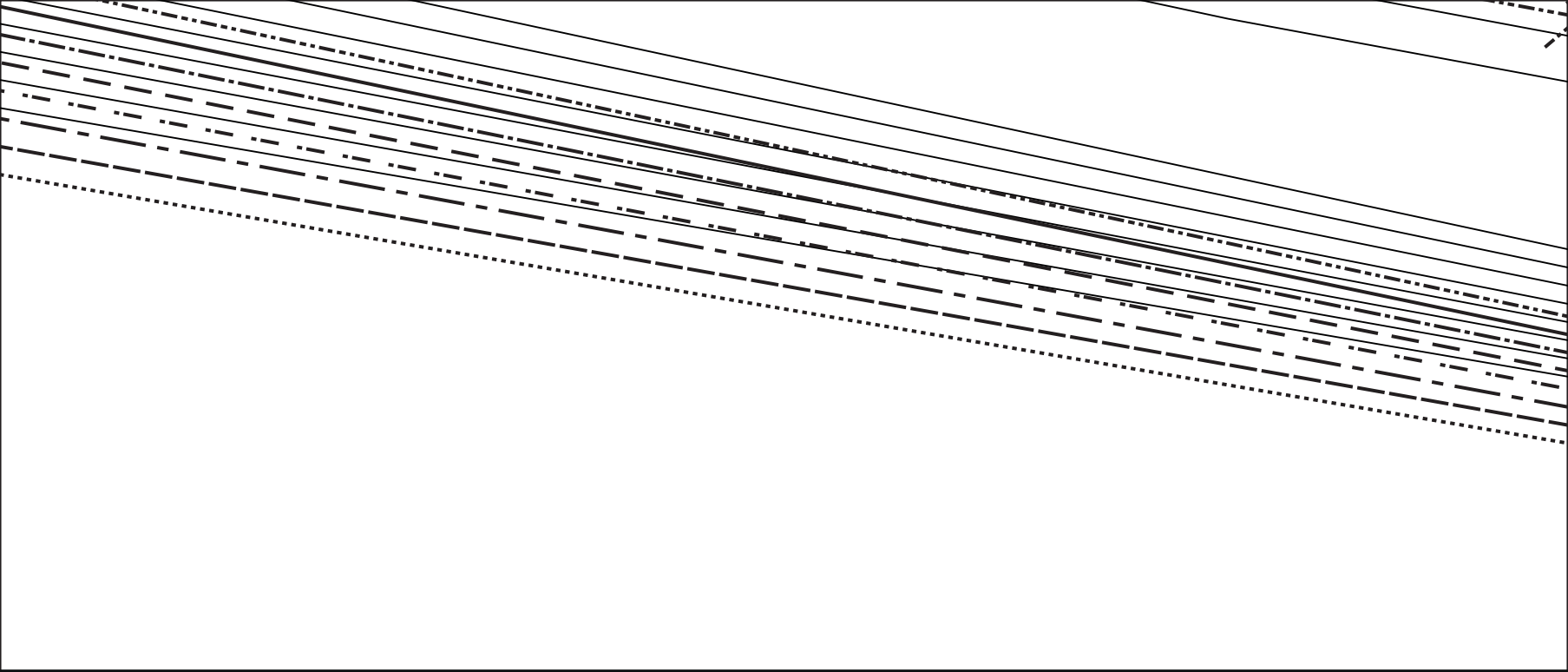

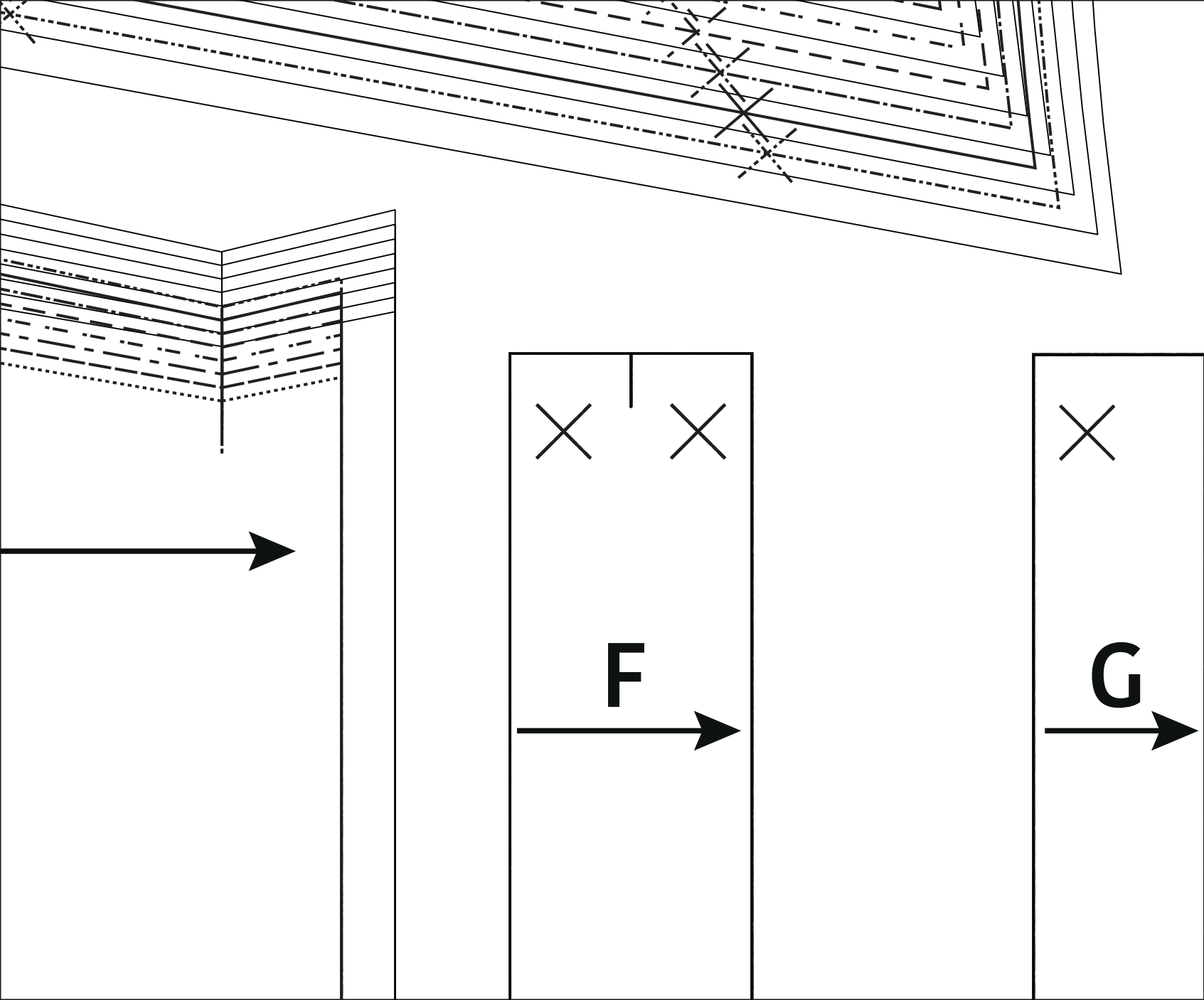

		MR/MDS/CB/RM
		MR/MDS/CB/RM
		MR/MDS/CB/RM
		MR/MDS/CB/RM
		MR/MDS/CB/RM
		MR/MDS/CB/RM
		MR/MDS/CB/RM

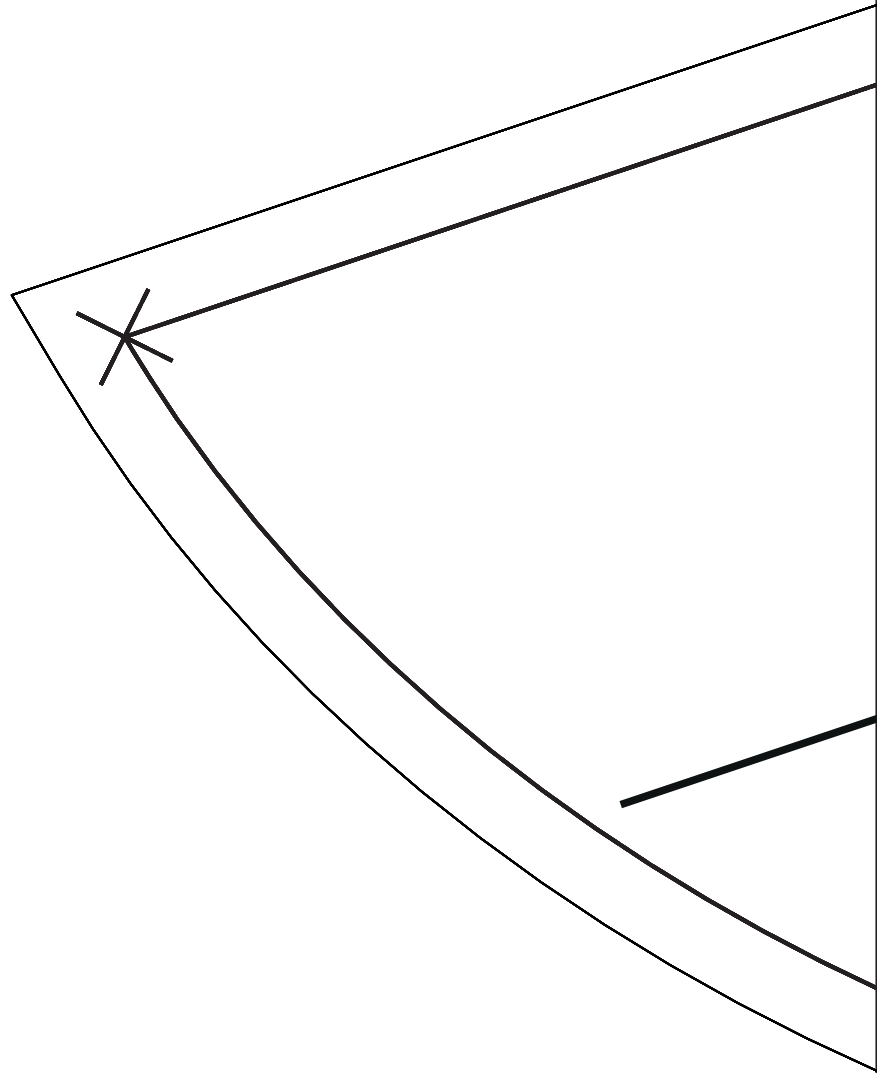

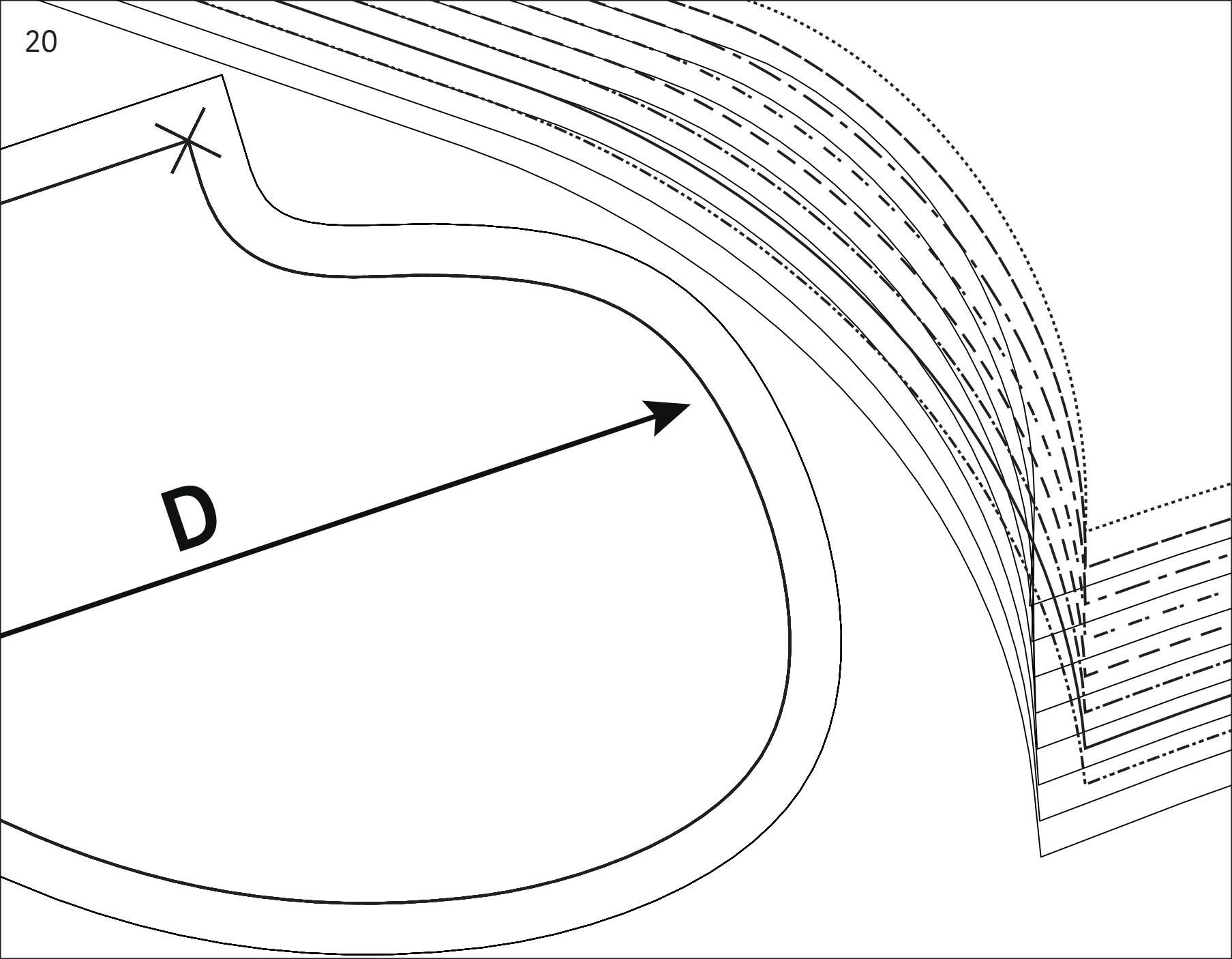

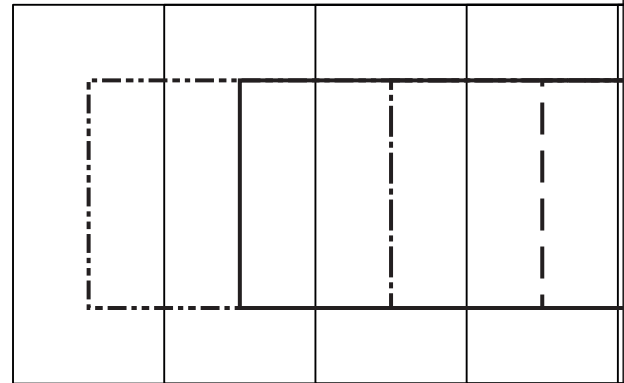
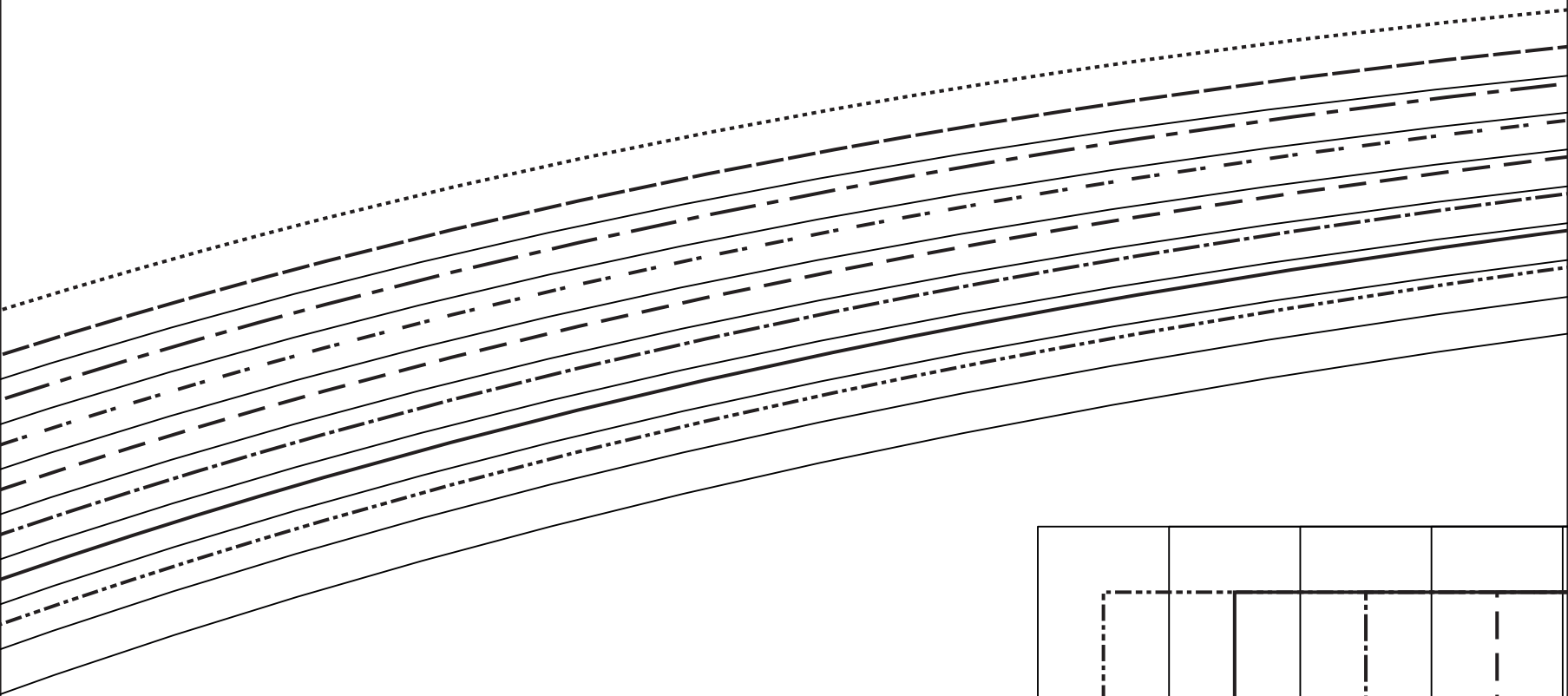

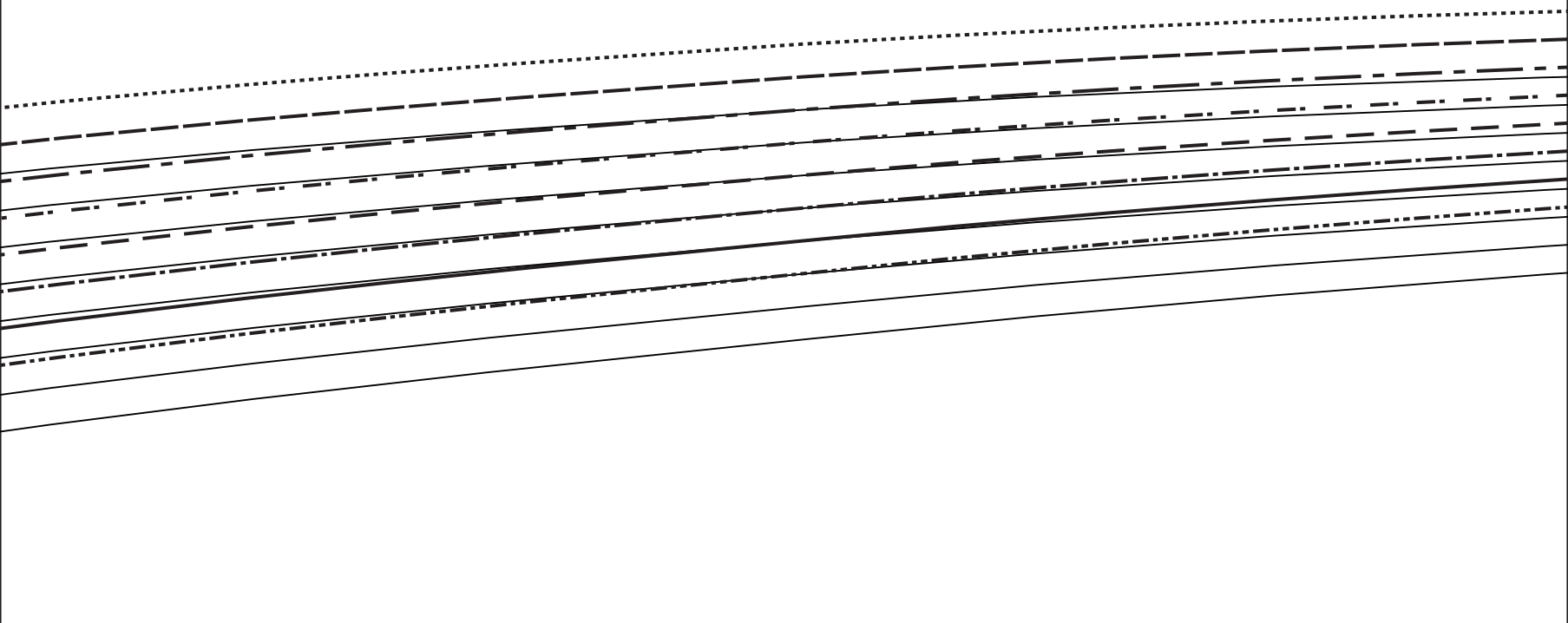

⋮	⋮	⋮	⋮

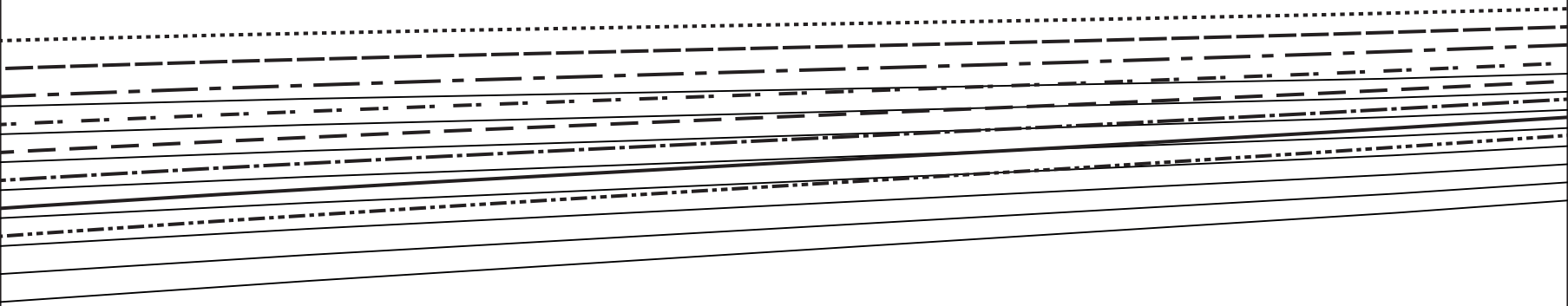

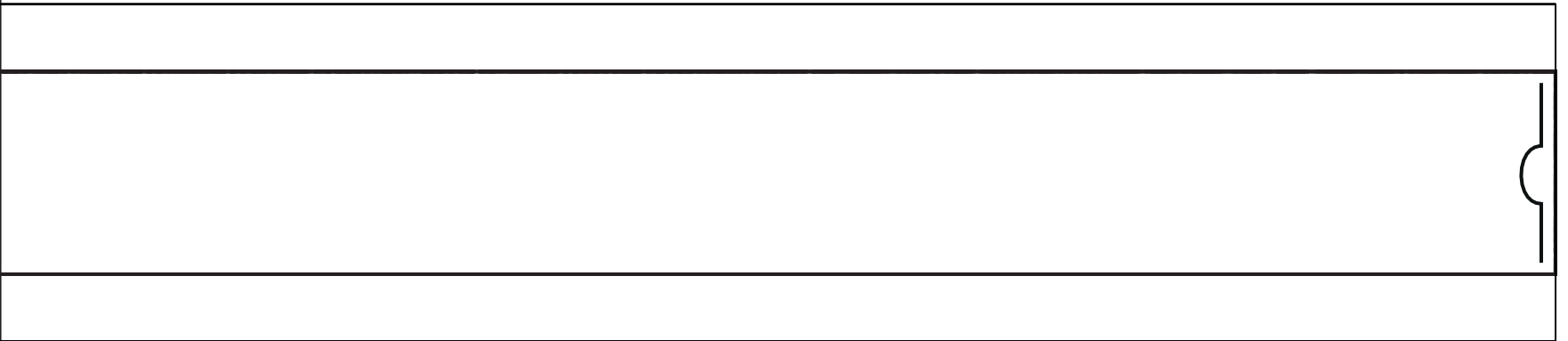
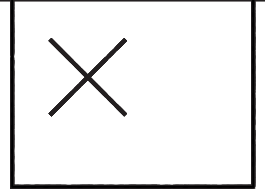
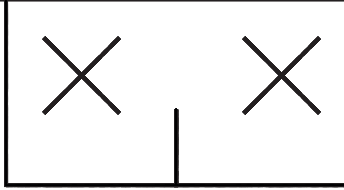
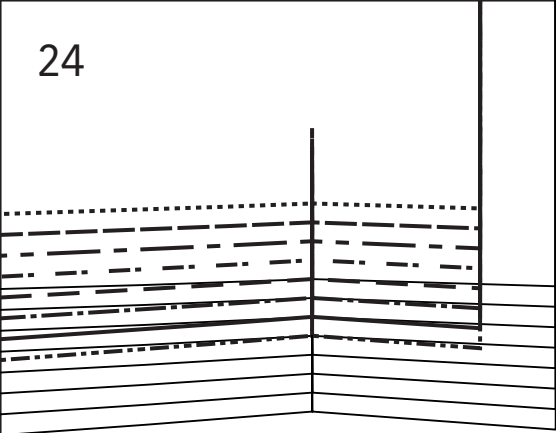

			MR/MDS/CB/RM
			MR/MDS/CB/RM