

Bianca

Trui / Pull / Jumper / Pullover

Maten / Tailles / Sizes / Größen:

-----	34
-----	36
-----	38
-----	40
-----	42
-----	44
-----	46
-----	48
-----	50
-----	52
-----	54
-----	56

Patroondelen / Pièces du patron / Pattern pieces / Schnittteile:

- A** voorpand / devant / front panel /
Vorderteil
- B** rugpand / dos / back panel /
Rückenteil
- C** polsboord / bord manche / cuff /
Ärmelbündchen

Patroonschema / Schéma du Patron / Pattern Diagram / Übersichtsplan zum Zusammenkleben

1	2	3	4	5	6
7	8	9	10	11	12
13	14	15	16	17	18
19	20	21	22	23	24

Controlevierkant / Carré de controle / Test square / Kontrollquadrat

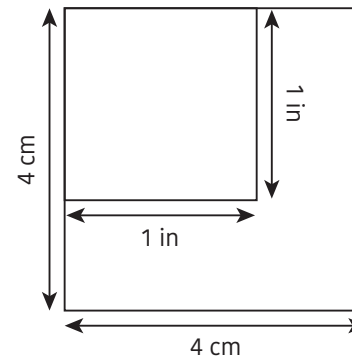

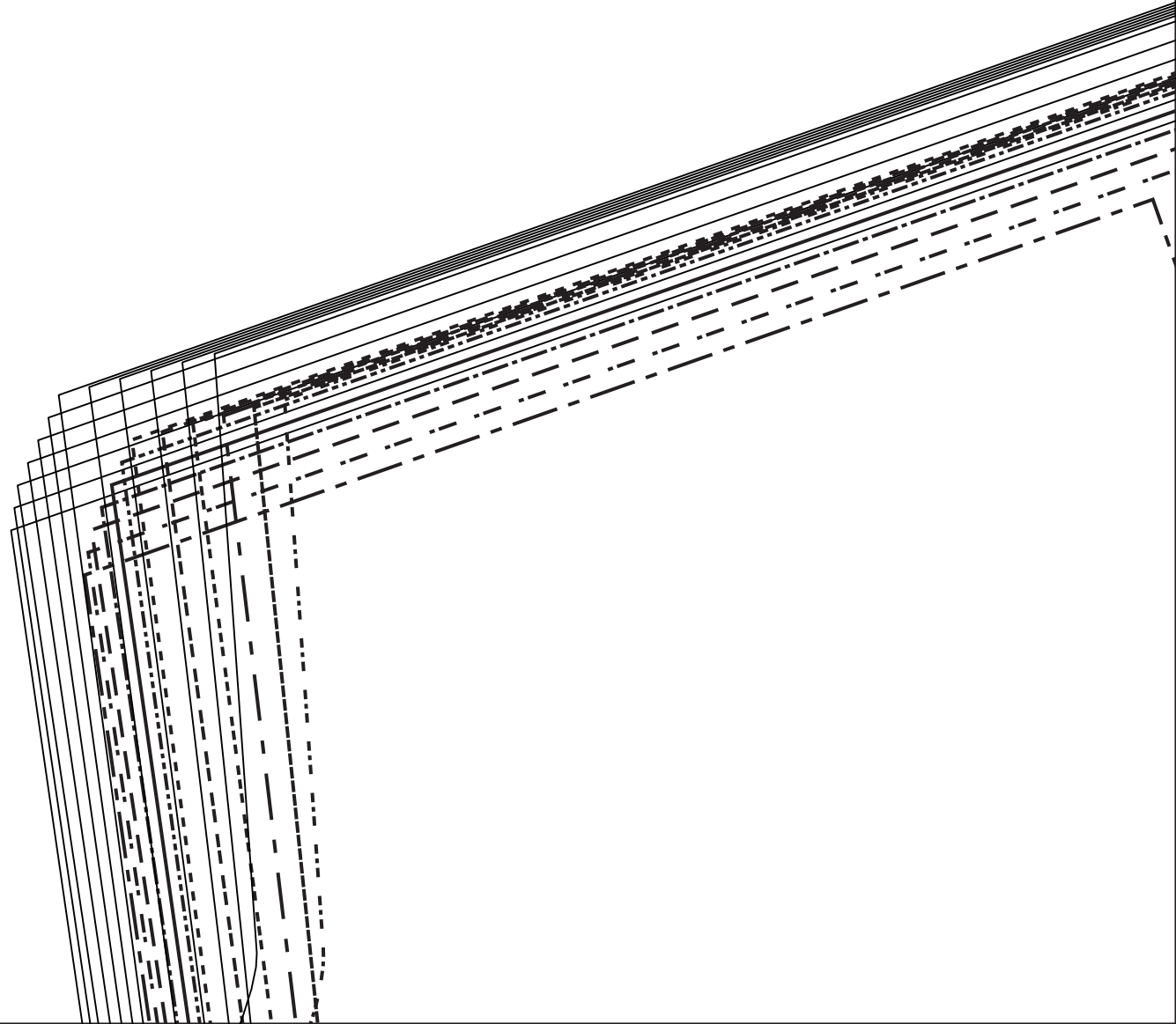

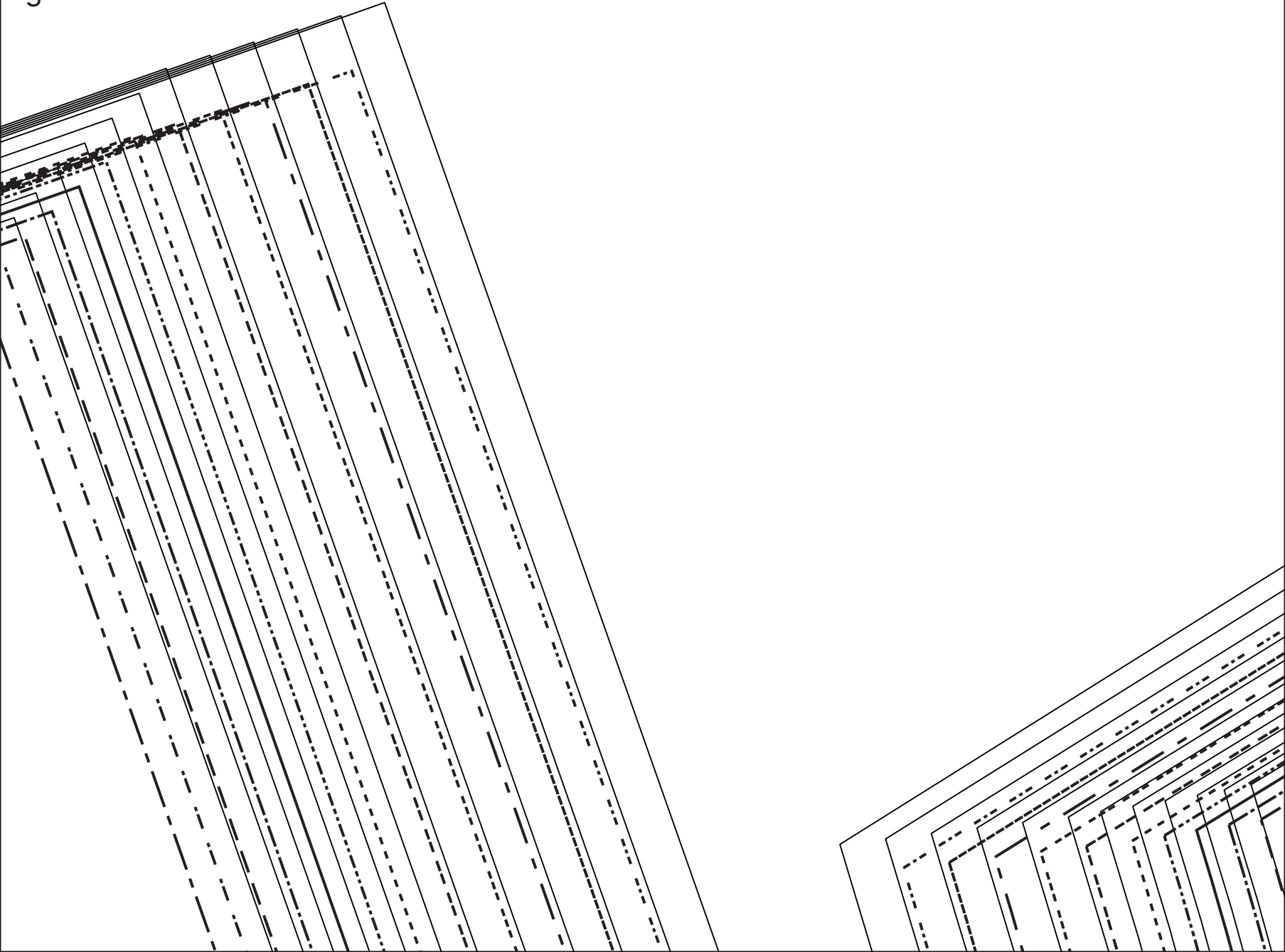

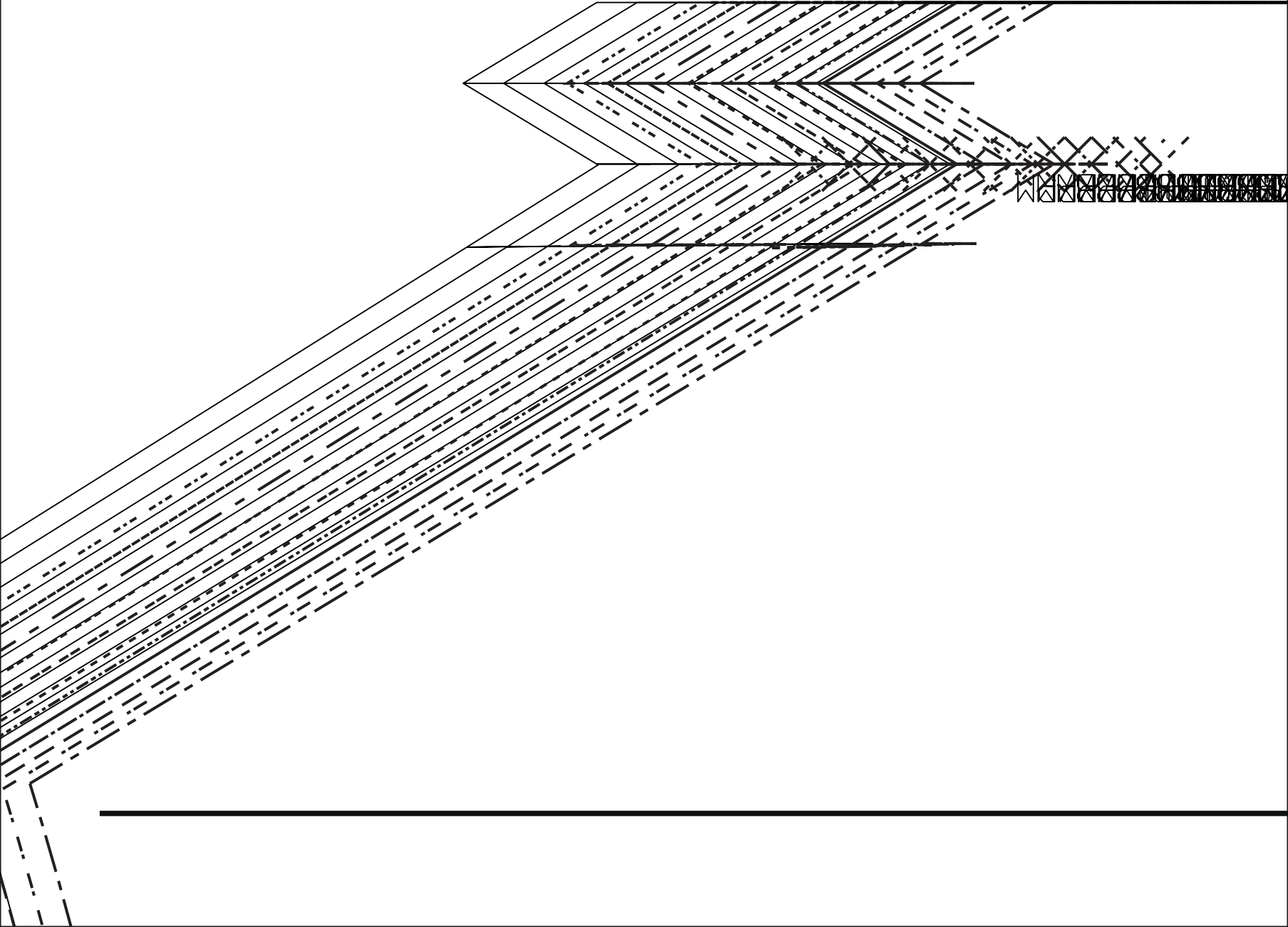

MR/MDS/CB/RM



B

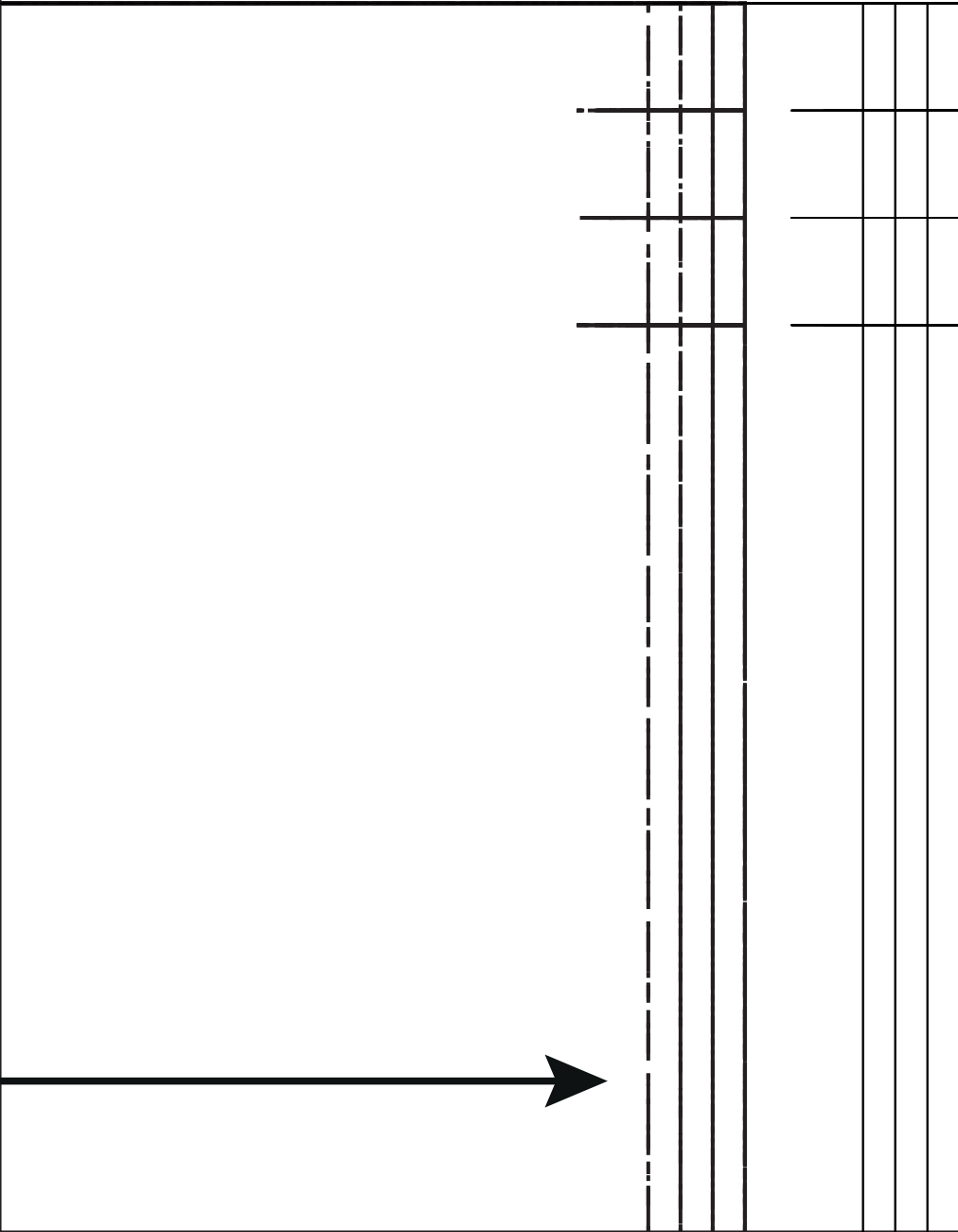

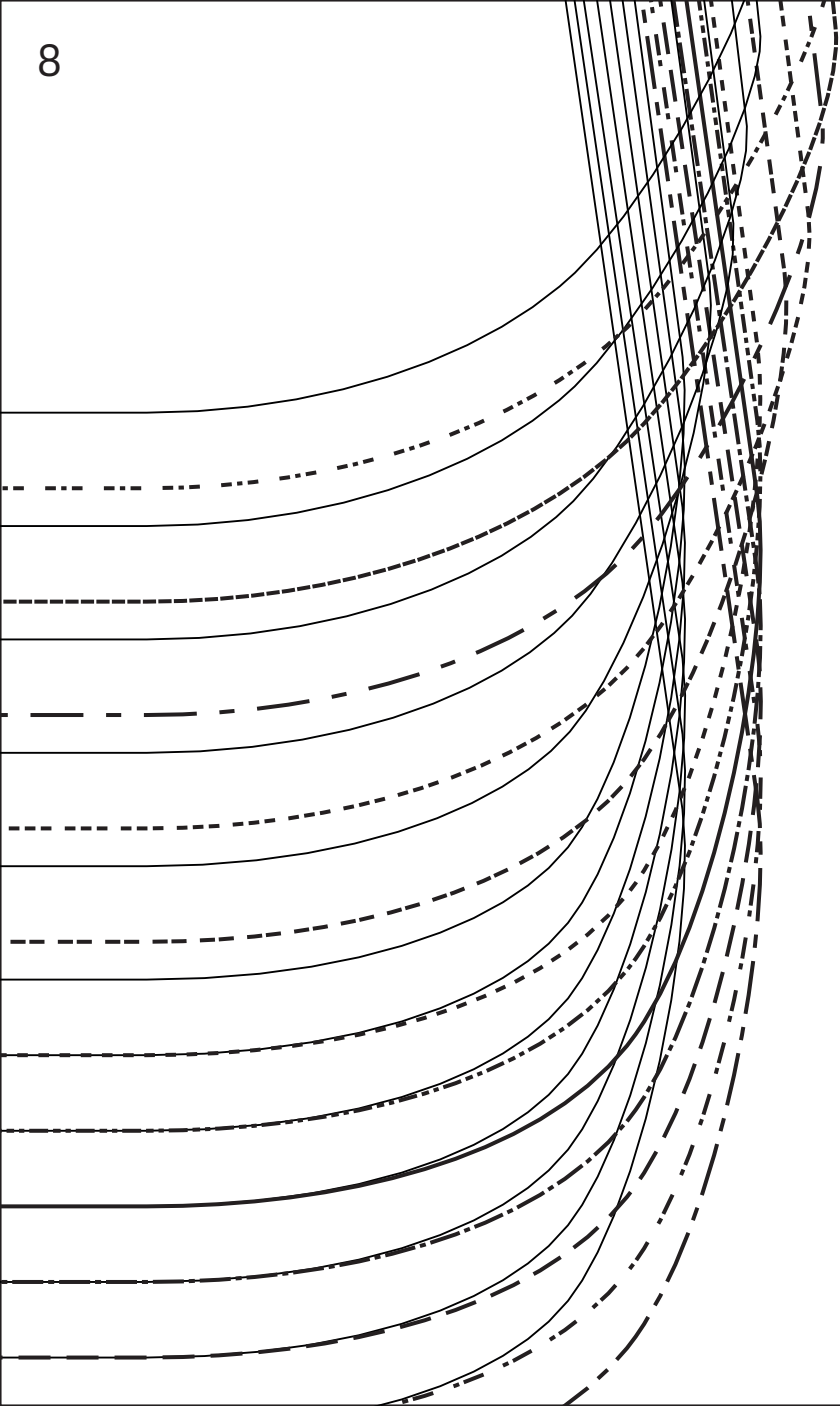

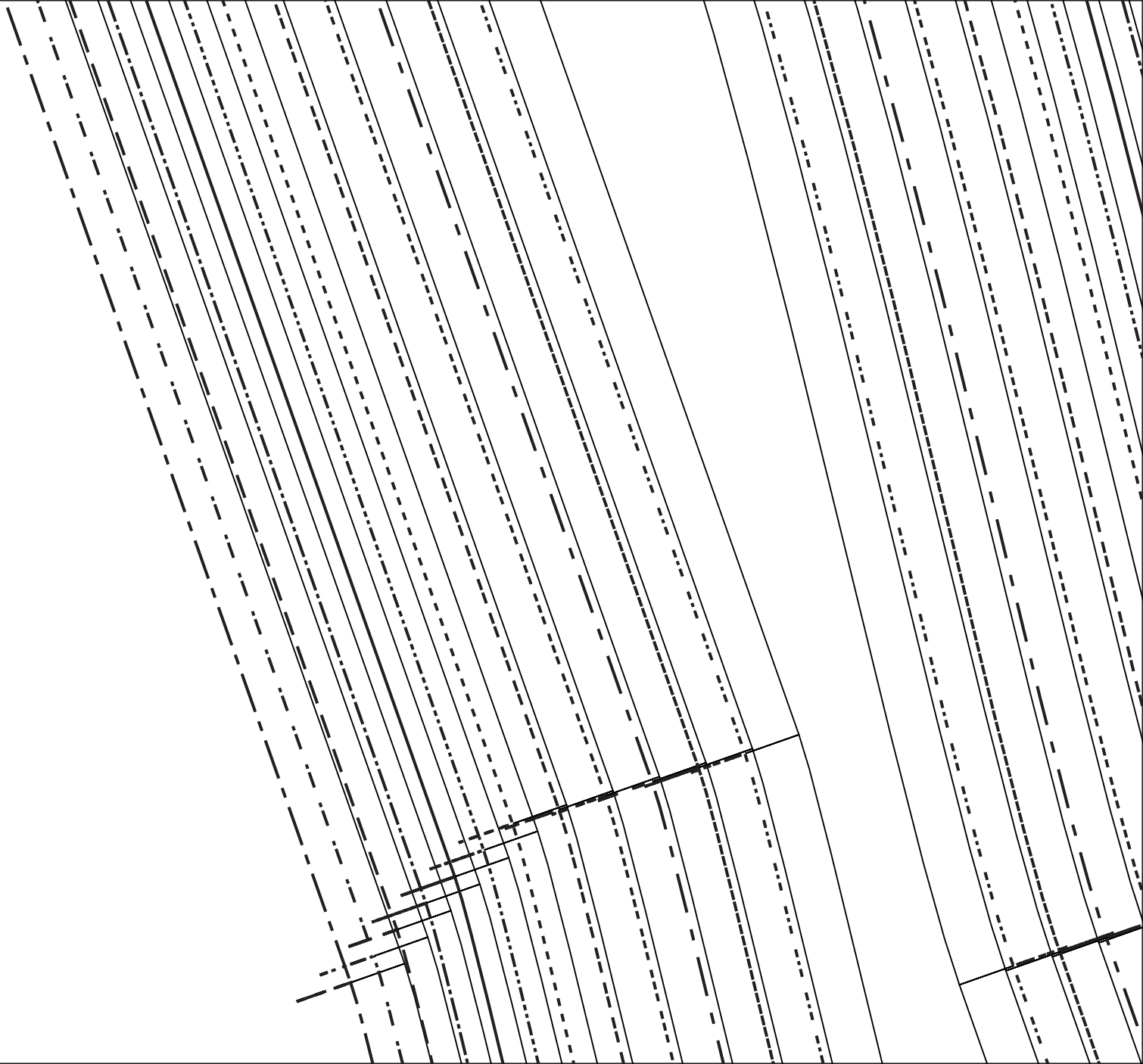

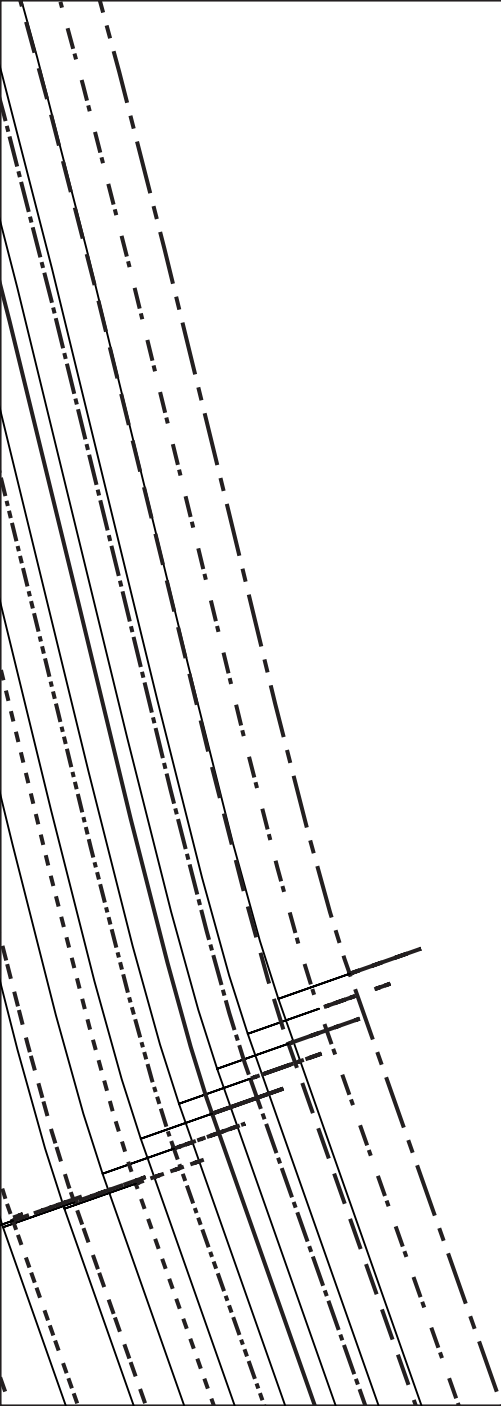

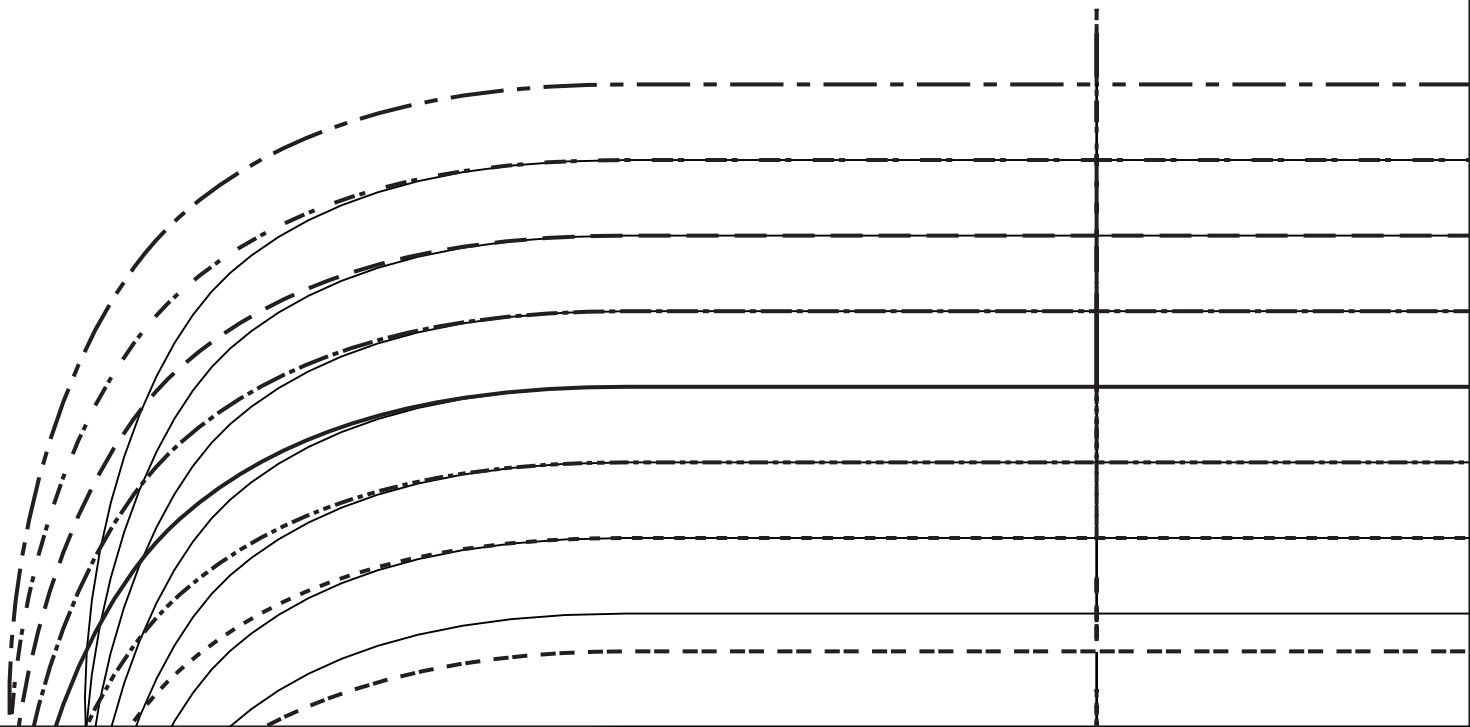

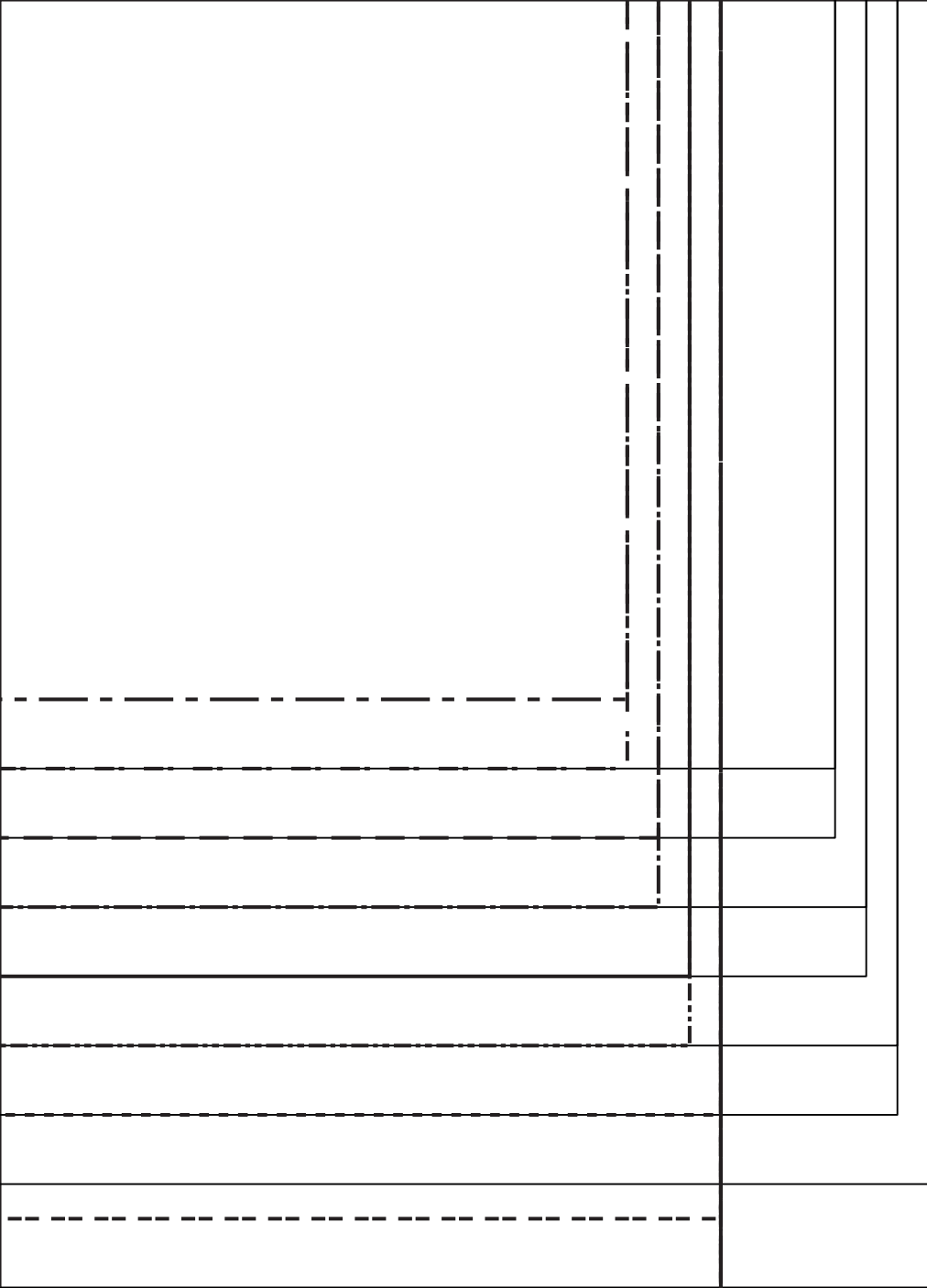

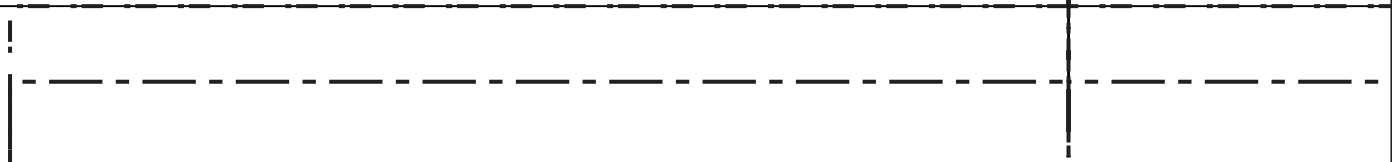

A

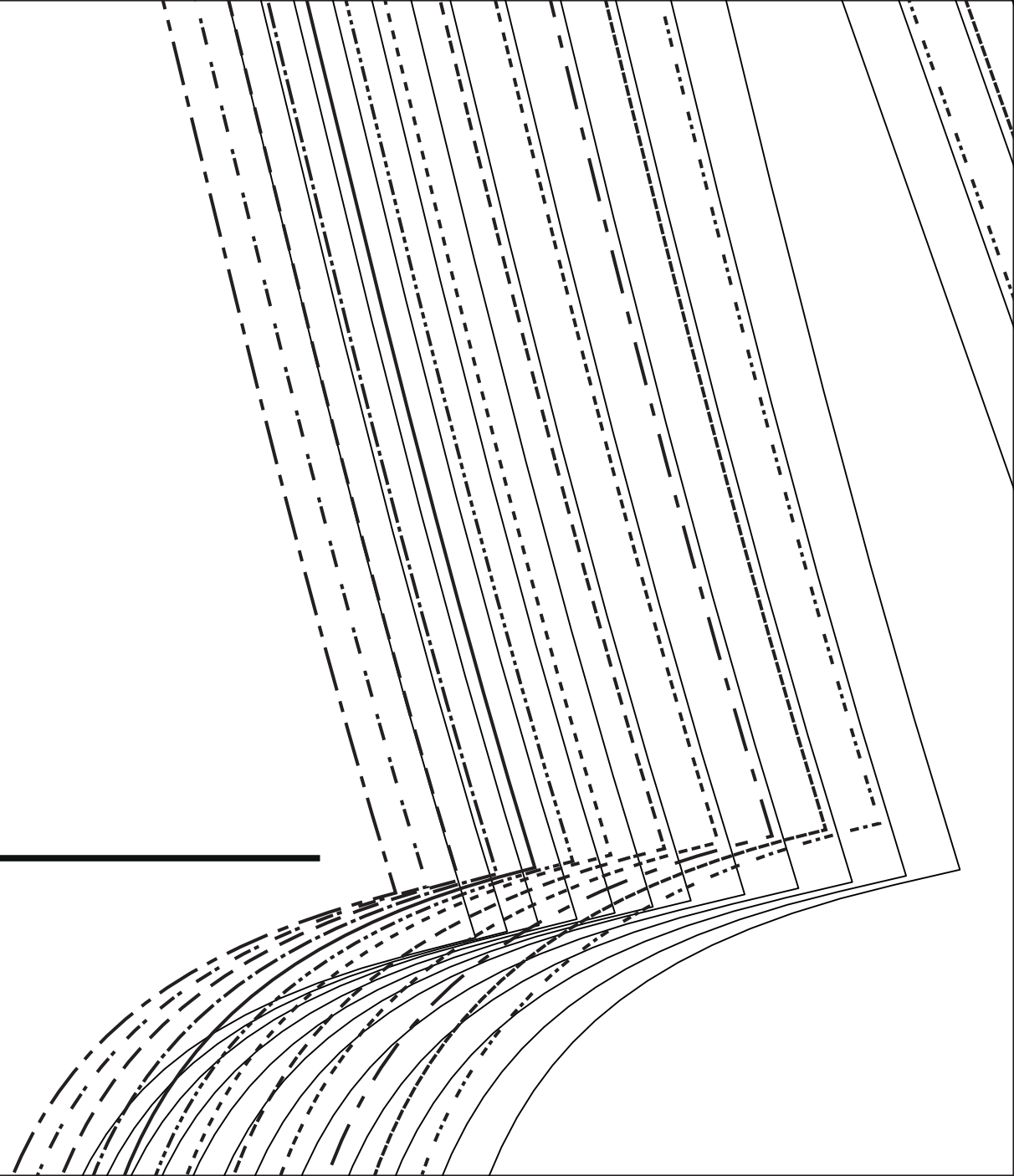

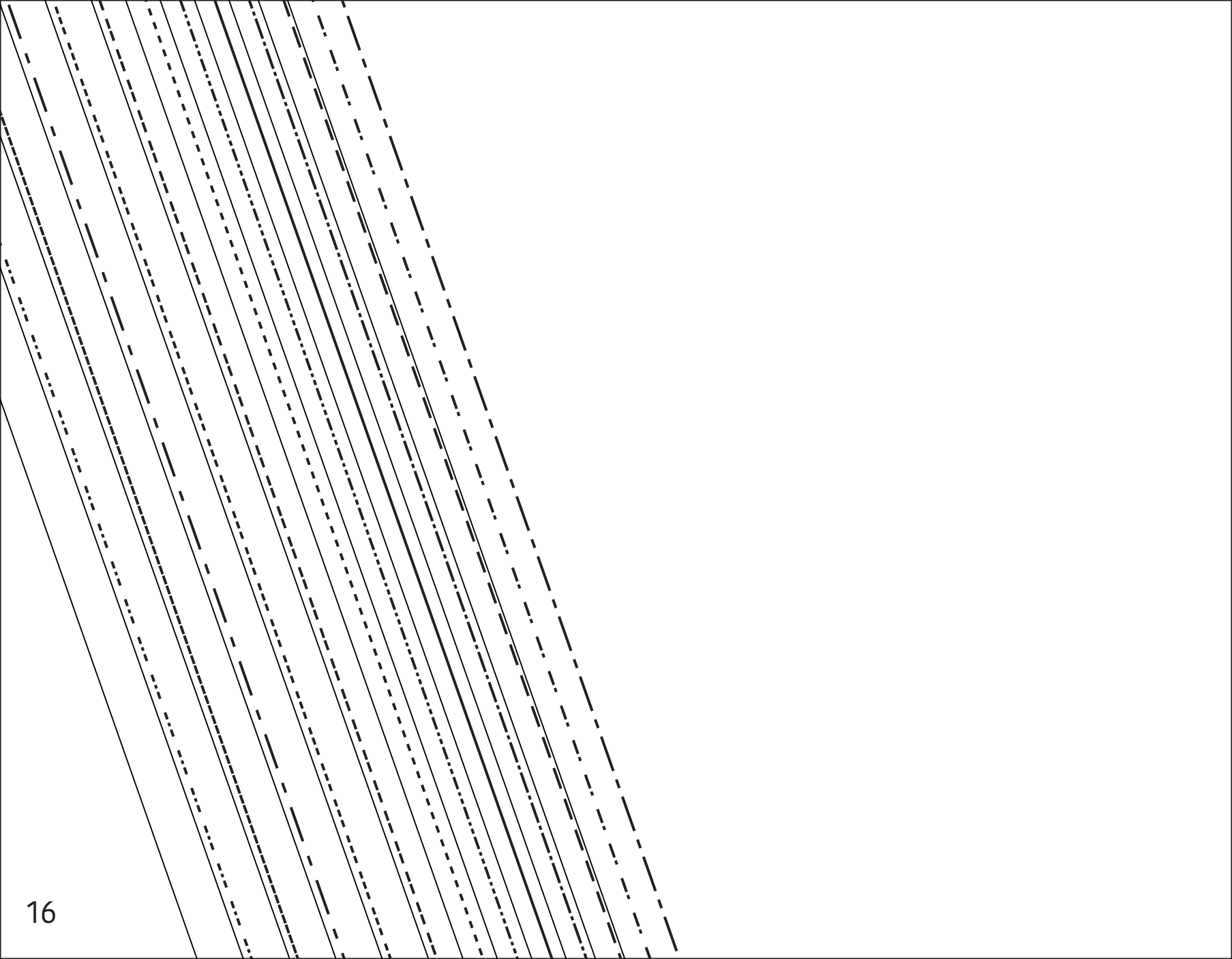

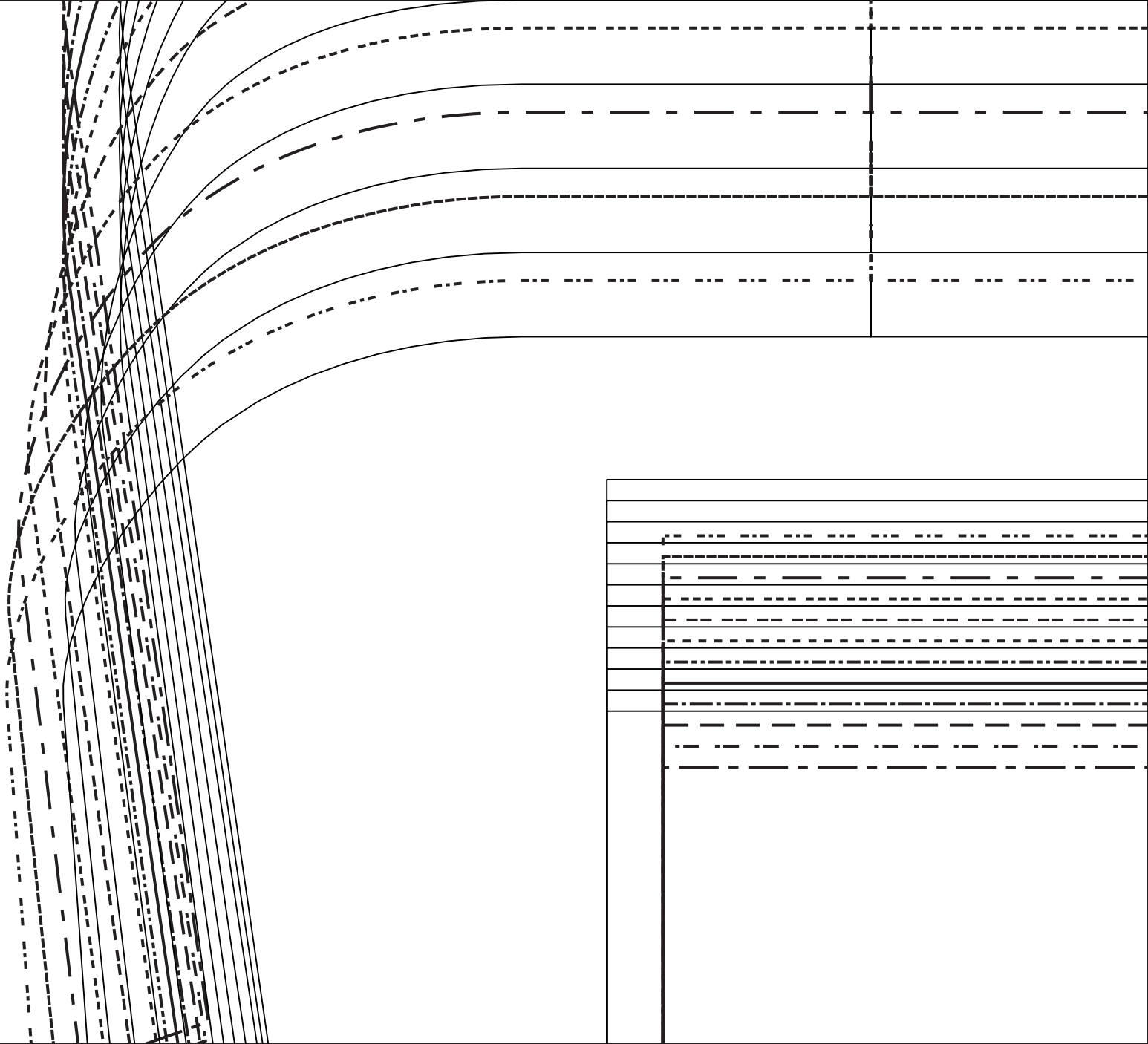

MV/MDV/CF/VM



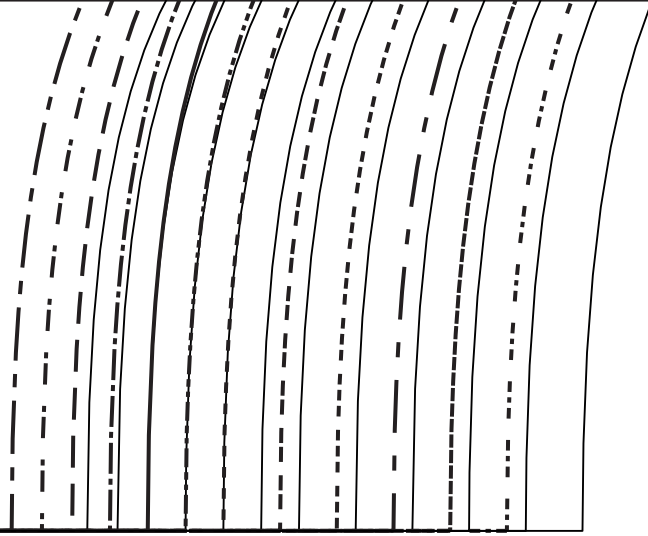

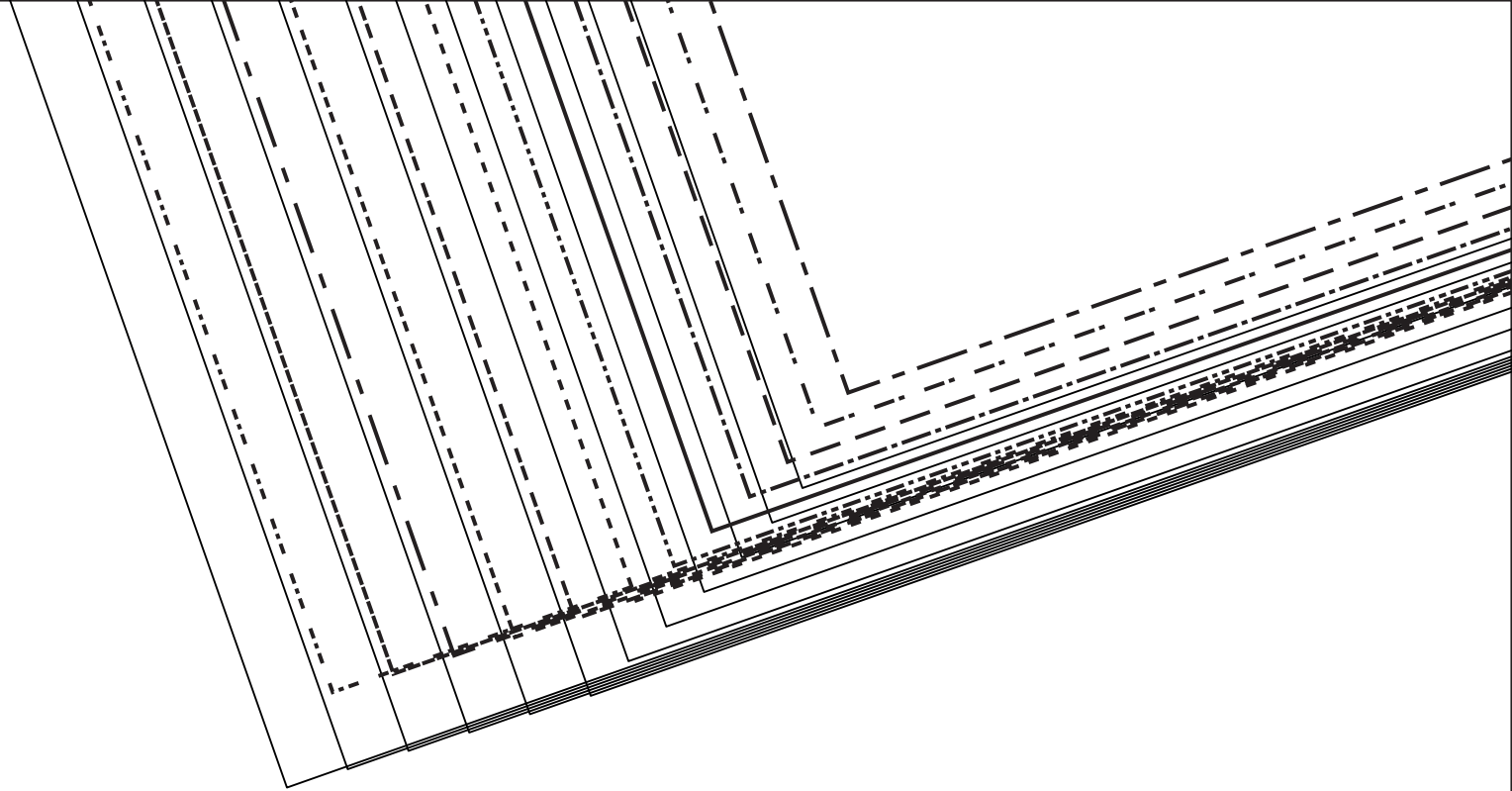

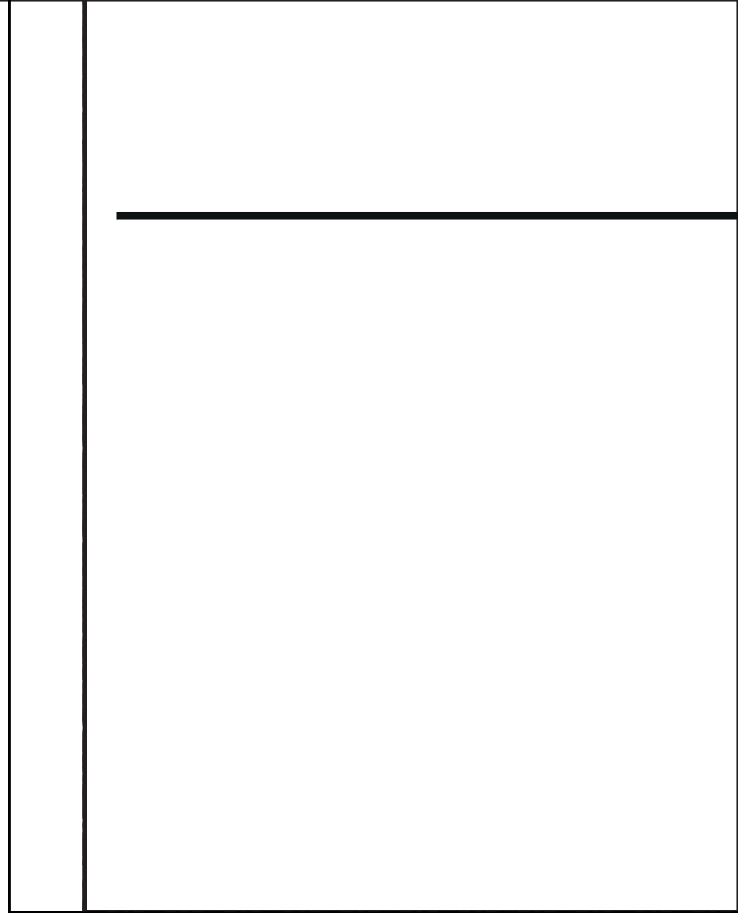
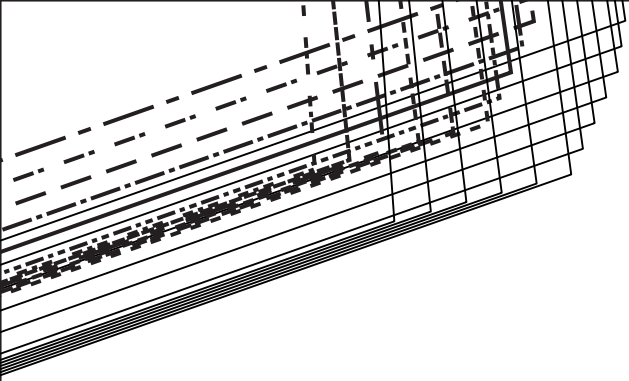

C

