

# Vicky

## Shacket

### Maten / Tailles / Sizes / Größen:

.....	30
-----	32
- - - - -	34
- . - . -	36
- - - - -	38
- . - . -	40
_____	42
- . - . -	44
- - - - -	46
- . - . -	48

### Patroondelen / Pièces du patron / Pattern pieces / Schnittteile:

- A** voorpand boven / devant haut / top FP / oberes Vorderteil
- B** voorpand onder / devant bas / bottom FP / unteres Vorderteil
- C** rugpand boven / devant haut / top BP / oberes Rückenteil
- D** rugpand onder / dos bas / bottom BP / unteres Rückenteil
- E** knopenpat / patte à boutons / button placket / Knopfleiste
- F** bovenmouw / haut de manche / upper sleeve / oberer Ärmel
- G** ondermouw / bas de manche / lower sleeve / onderer Ärmel
- H** polsboord / bord manchette / cuff / Manschette
- I** beleg VP / parementure DV / facing FP / Besatz VT
- J** beleg RP / parementure DS / facing BP / Besatz RT
- K** kraag / col / collar / Kragen
- L** zakklep / rabat de poche / pocket flap / Taschenklappe
- M** zak / poche / pocket / Tasche

Patroonschema / Schéma du Patron / Pattern Diagram /  
Übersichtsplan zum Zusammenkleben

1	2	3	4	5	6
7	8	9	10	11	12
13	14	15	16	17	18
19	20	21	22	23	24
25	26	27	28	29	30

Controlevierkant / Carré de controle  
/ Test square / Kontrollquadrat

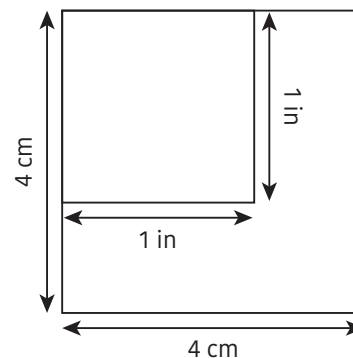

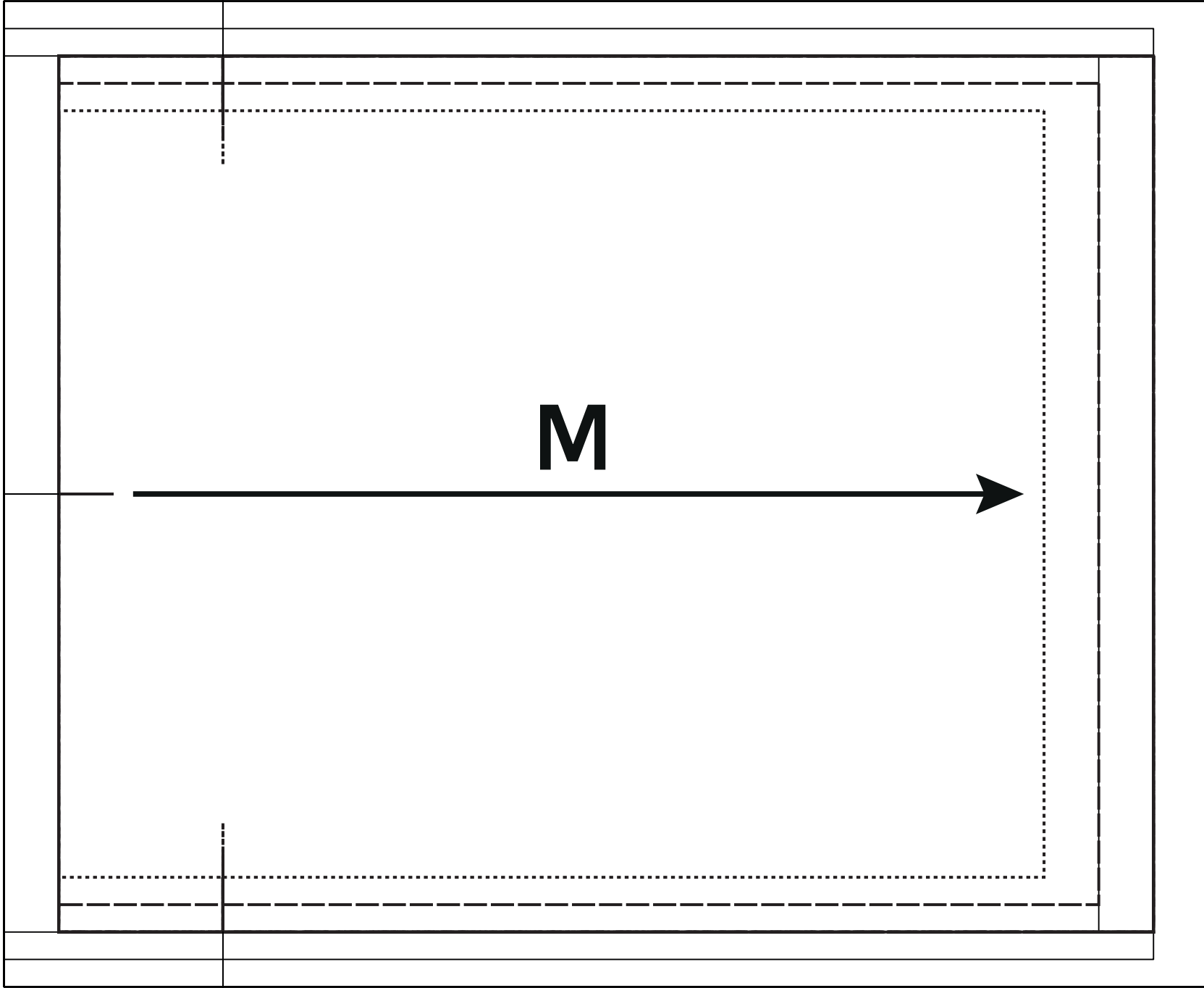

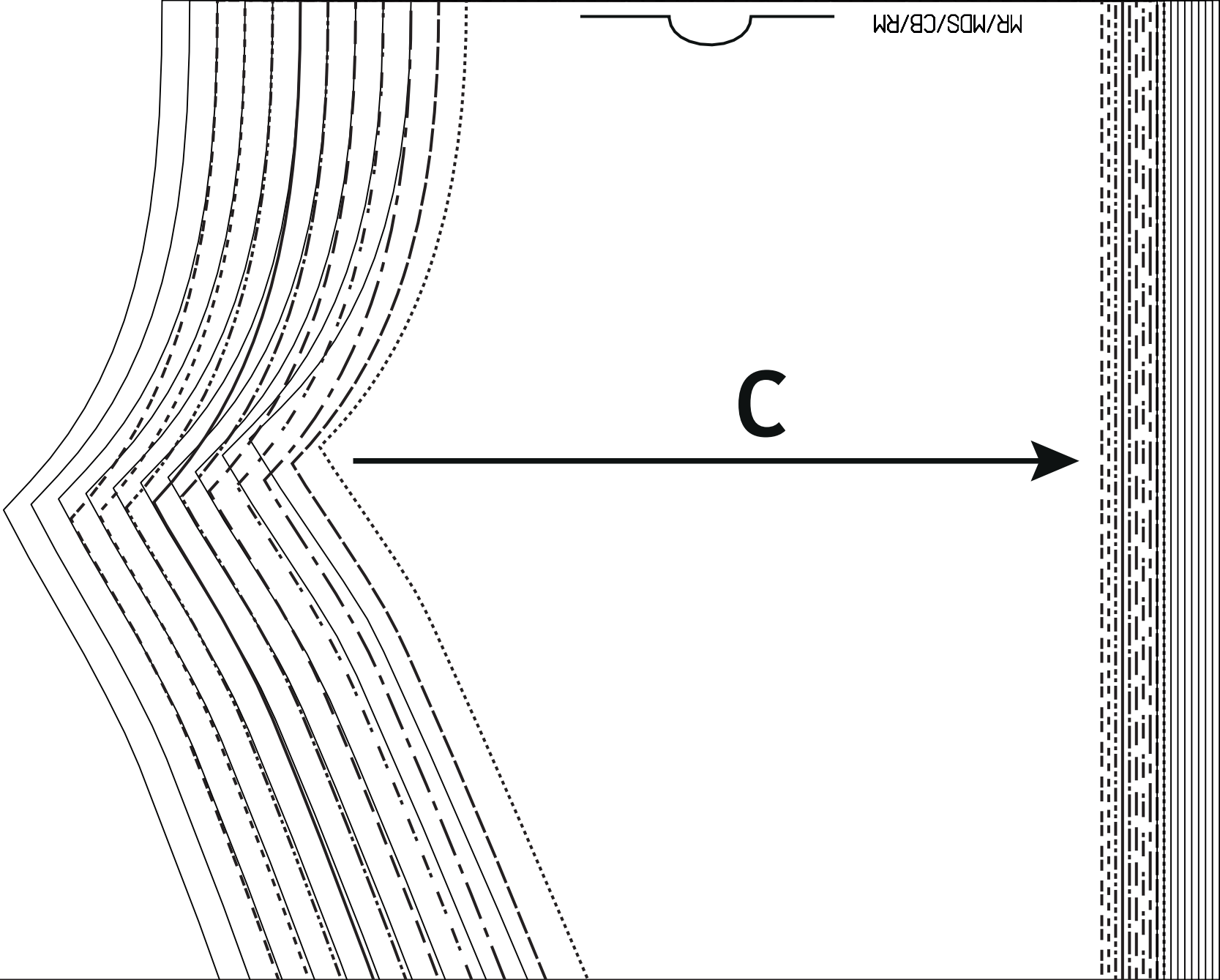

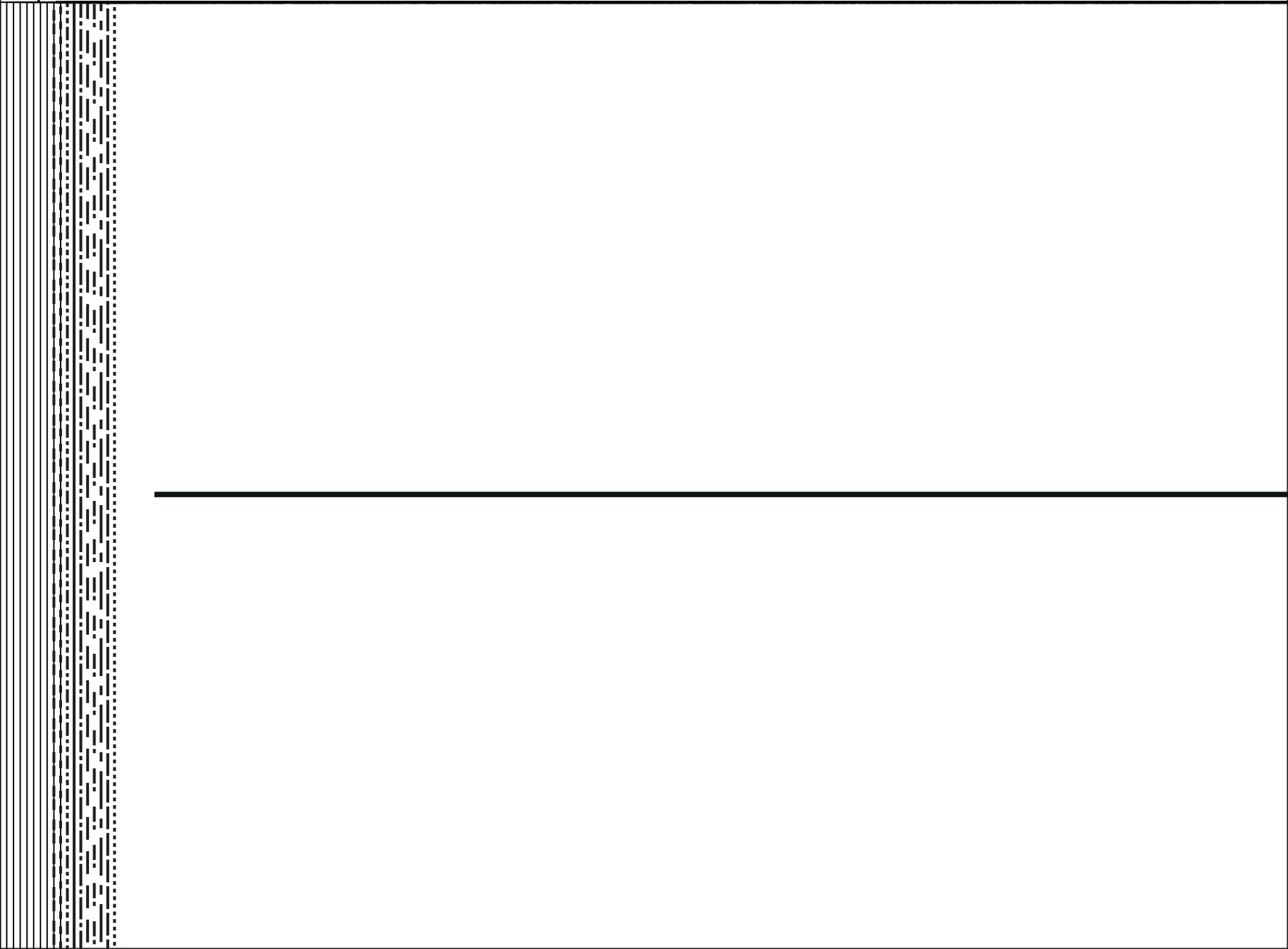

MR/MDS/CB/RM



**D**



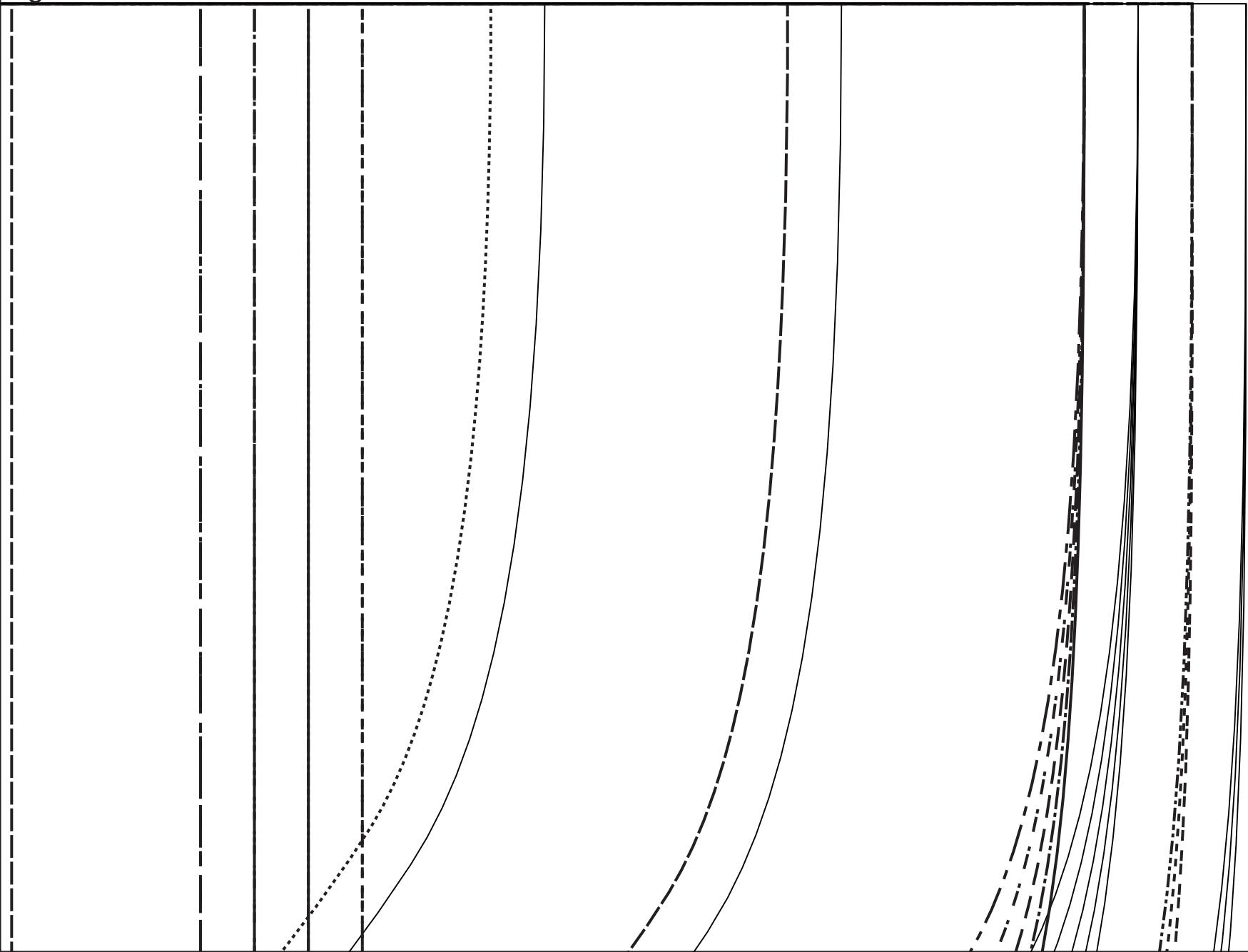

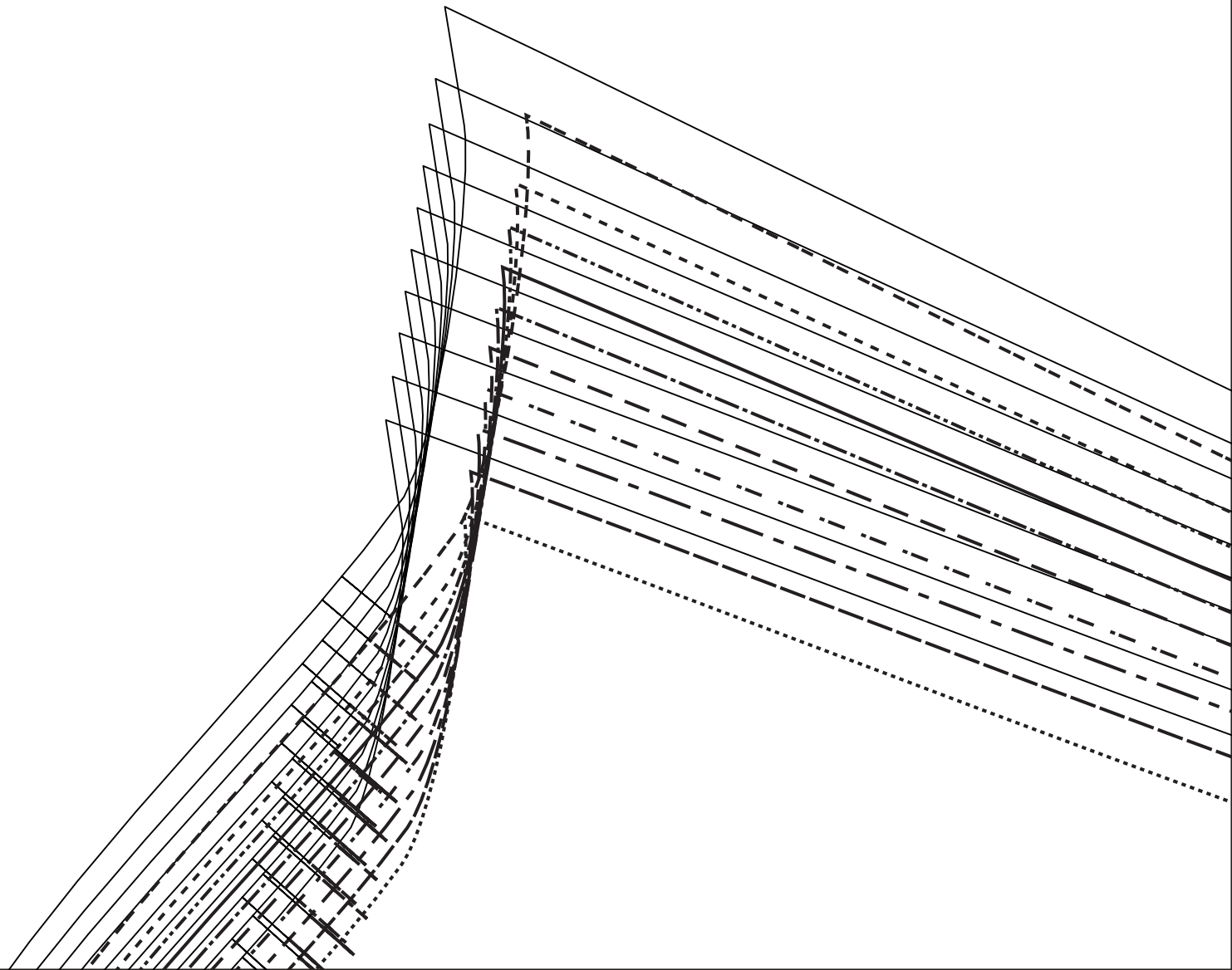

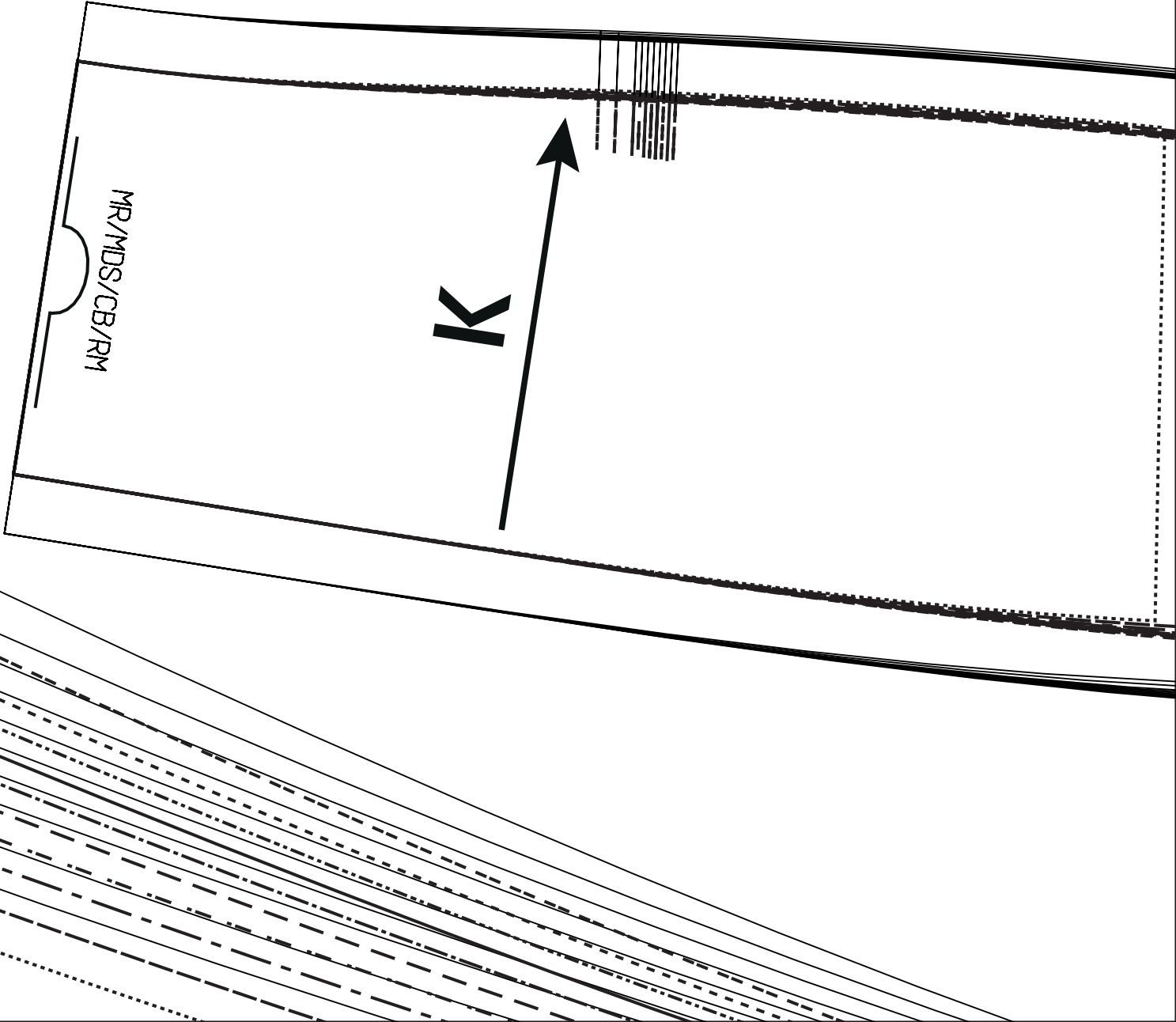



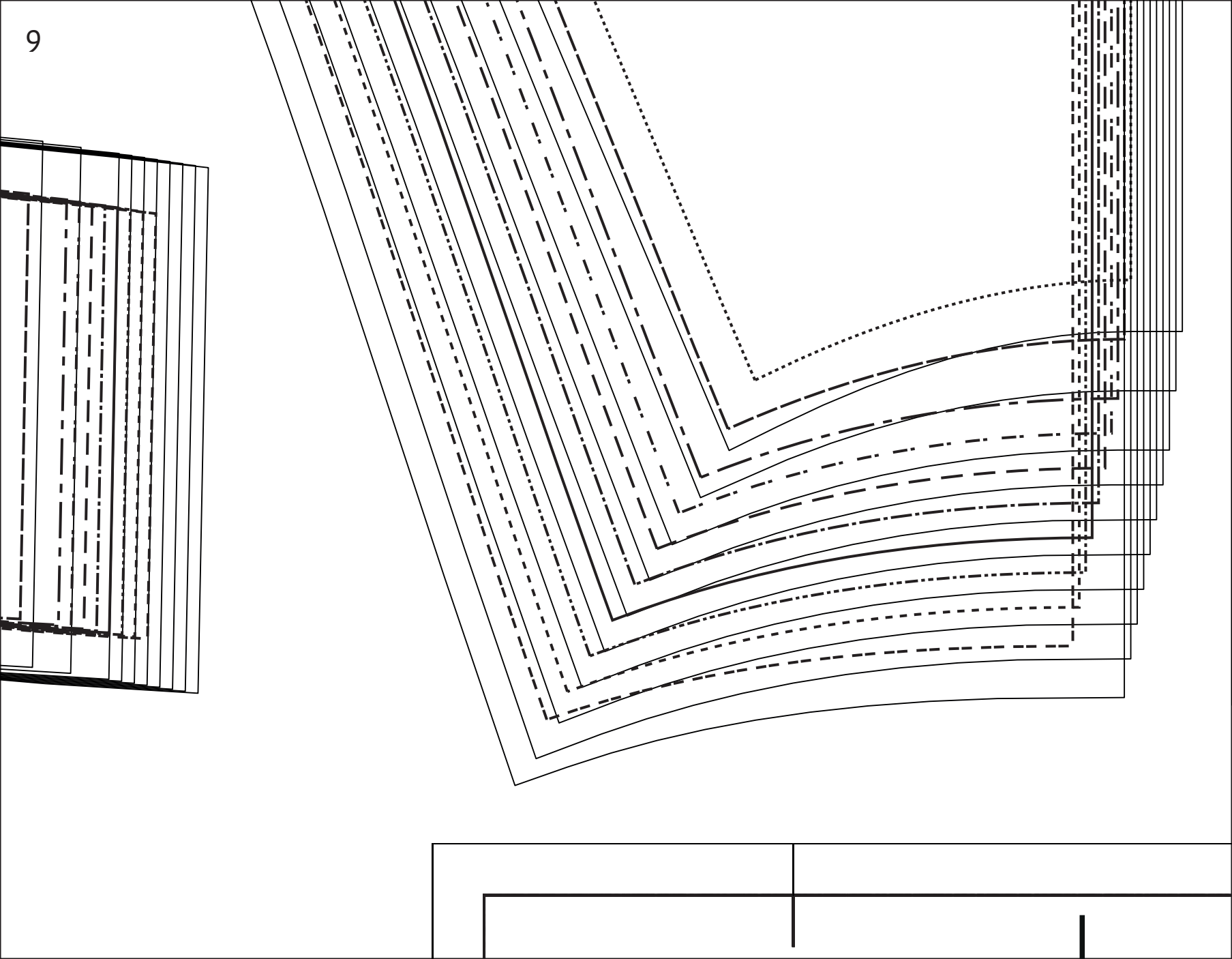

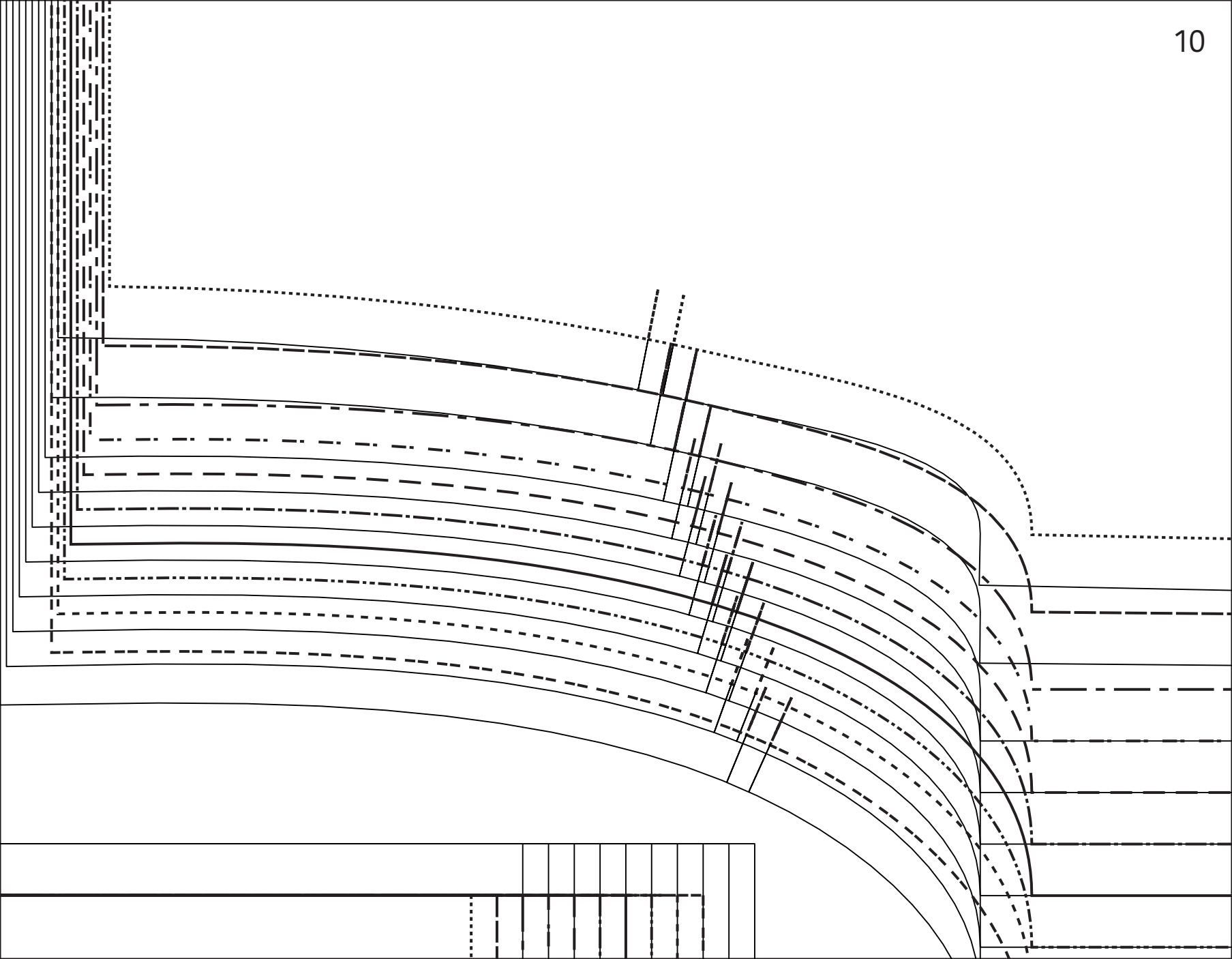

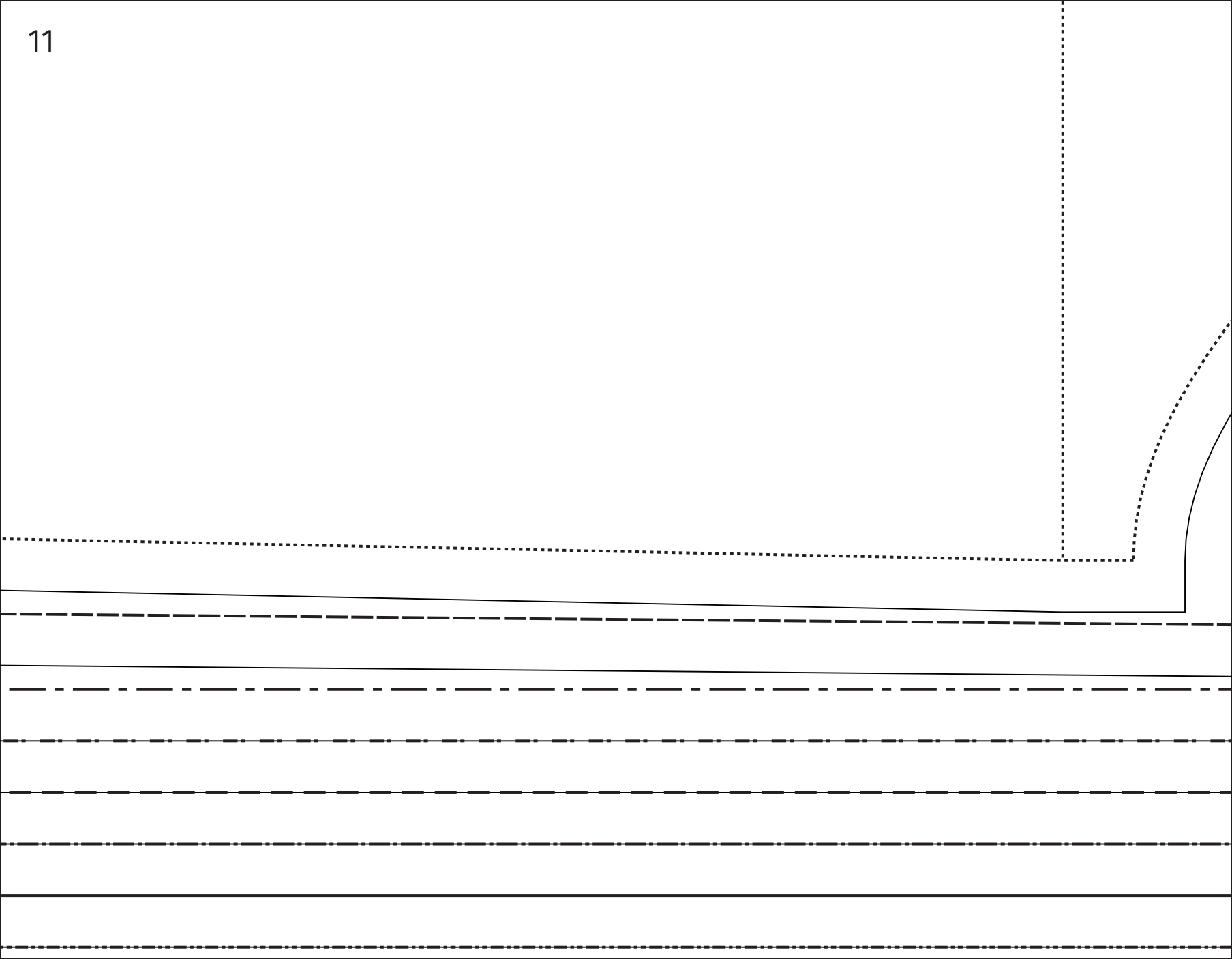

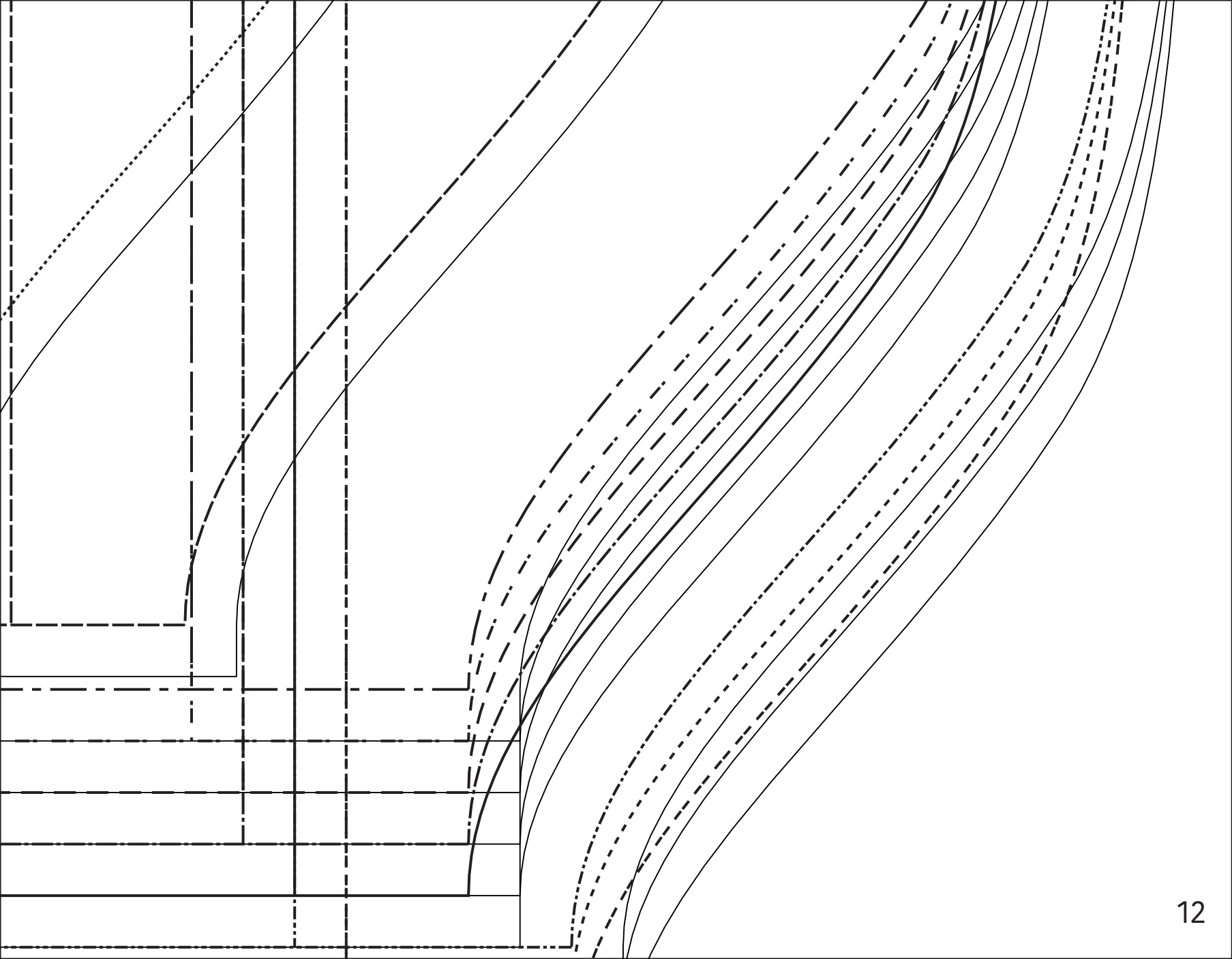

G

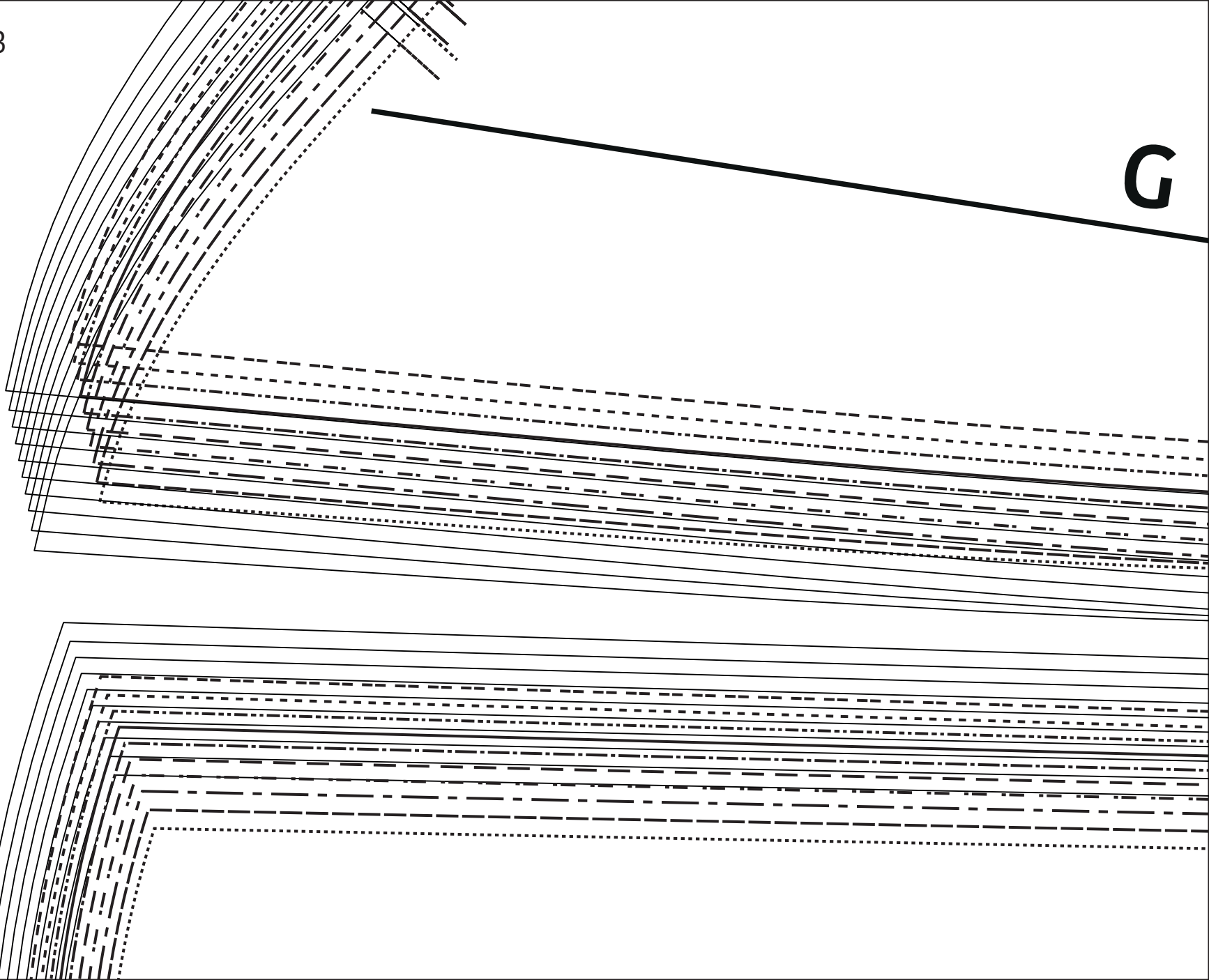

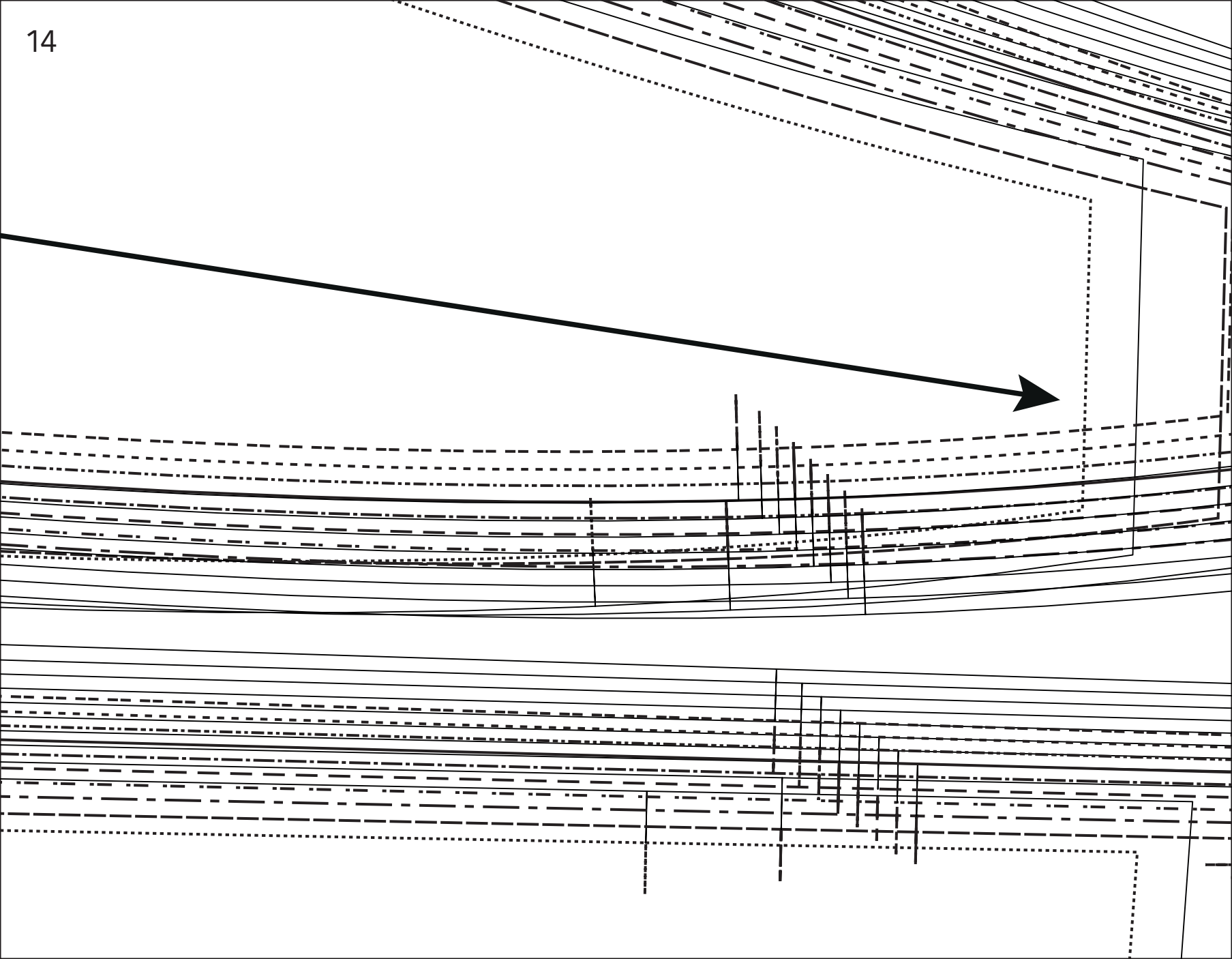

15

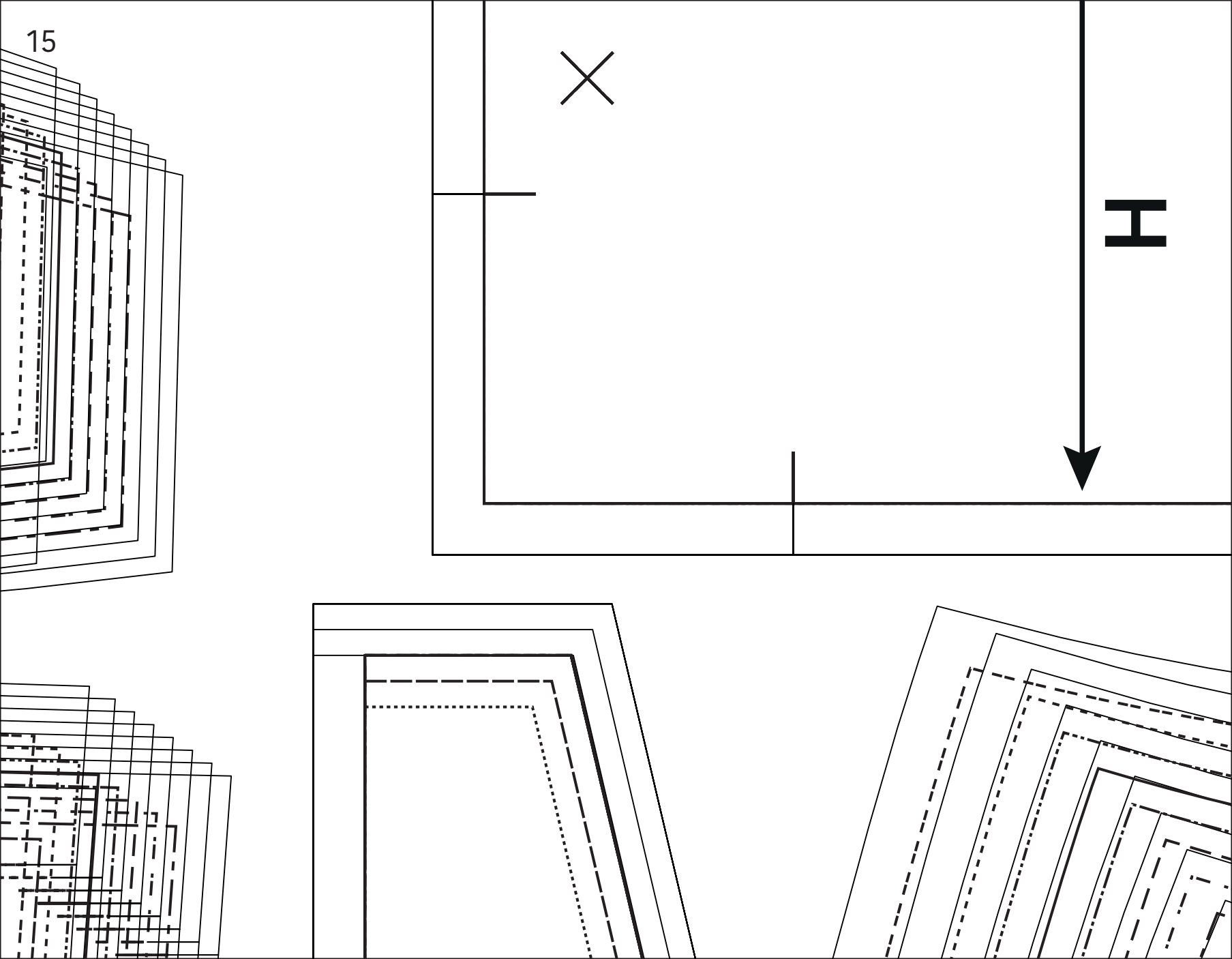

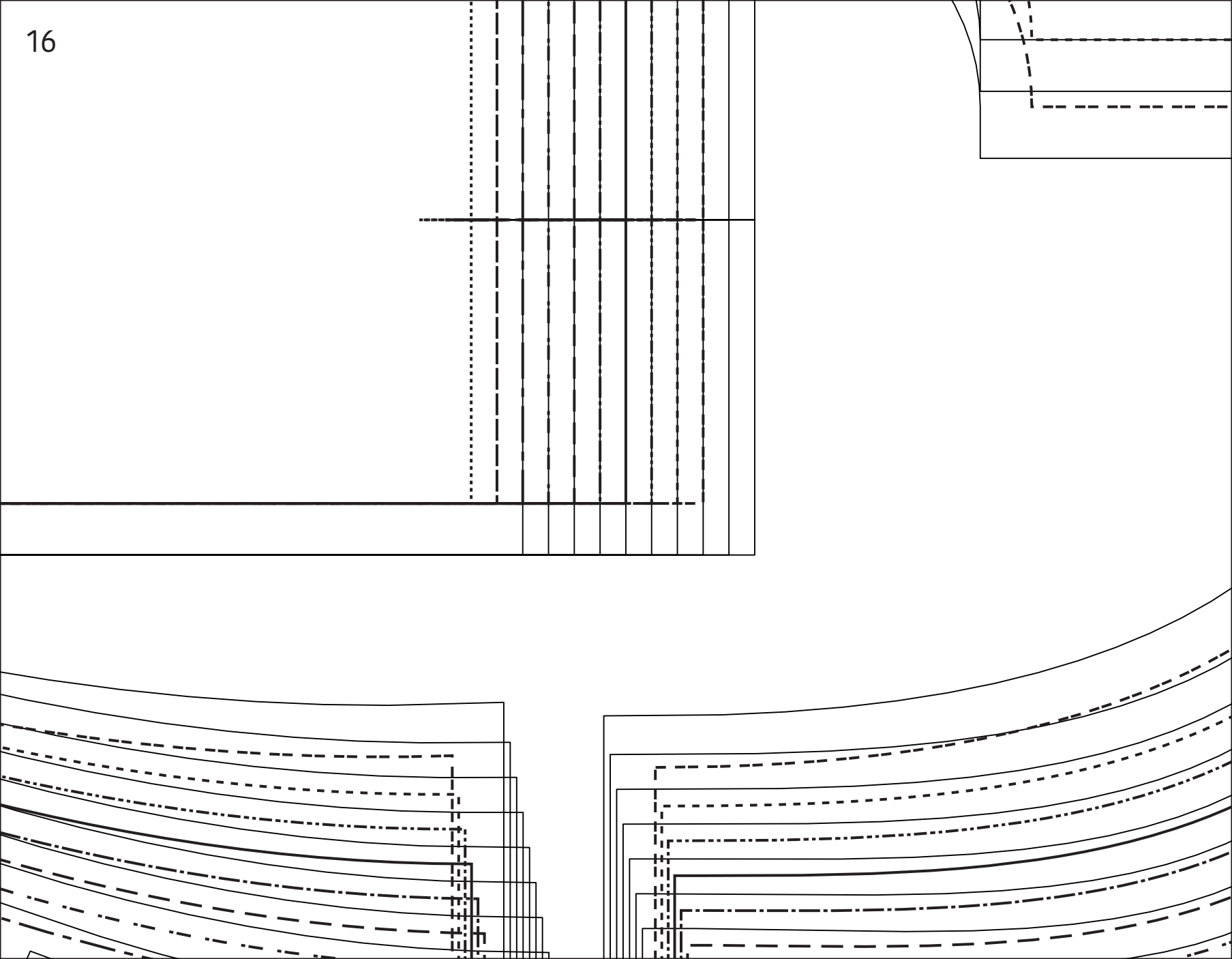



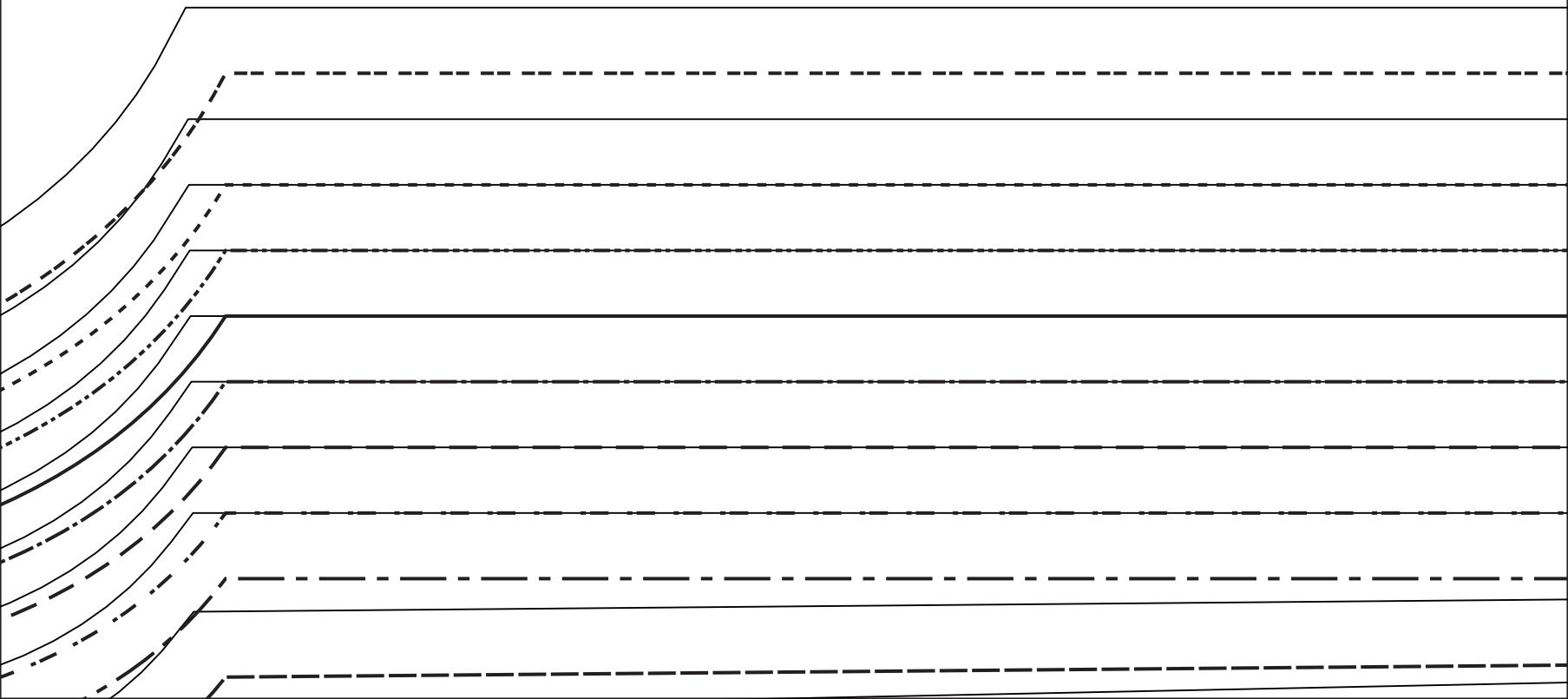

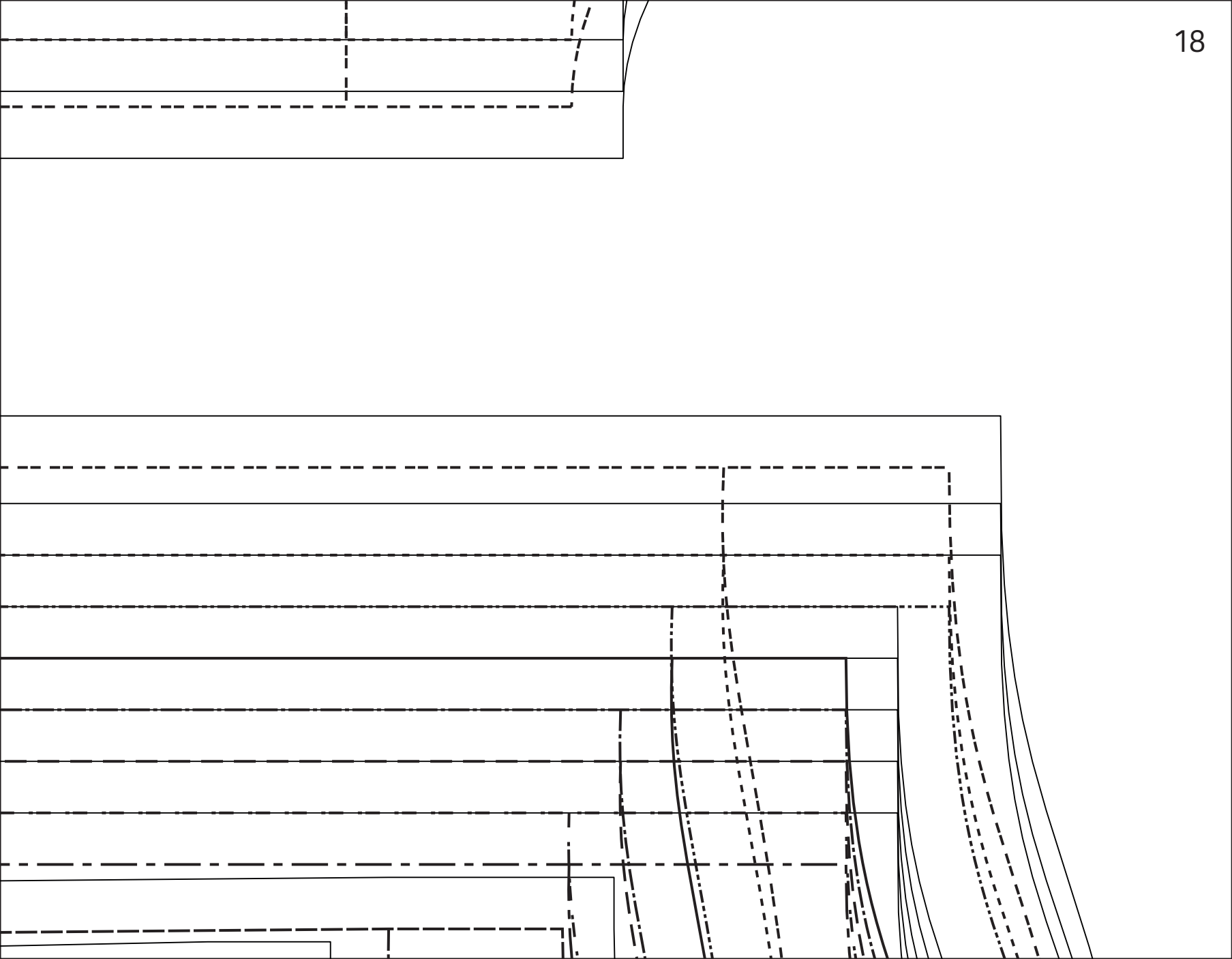

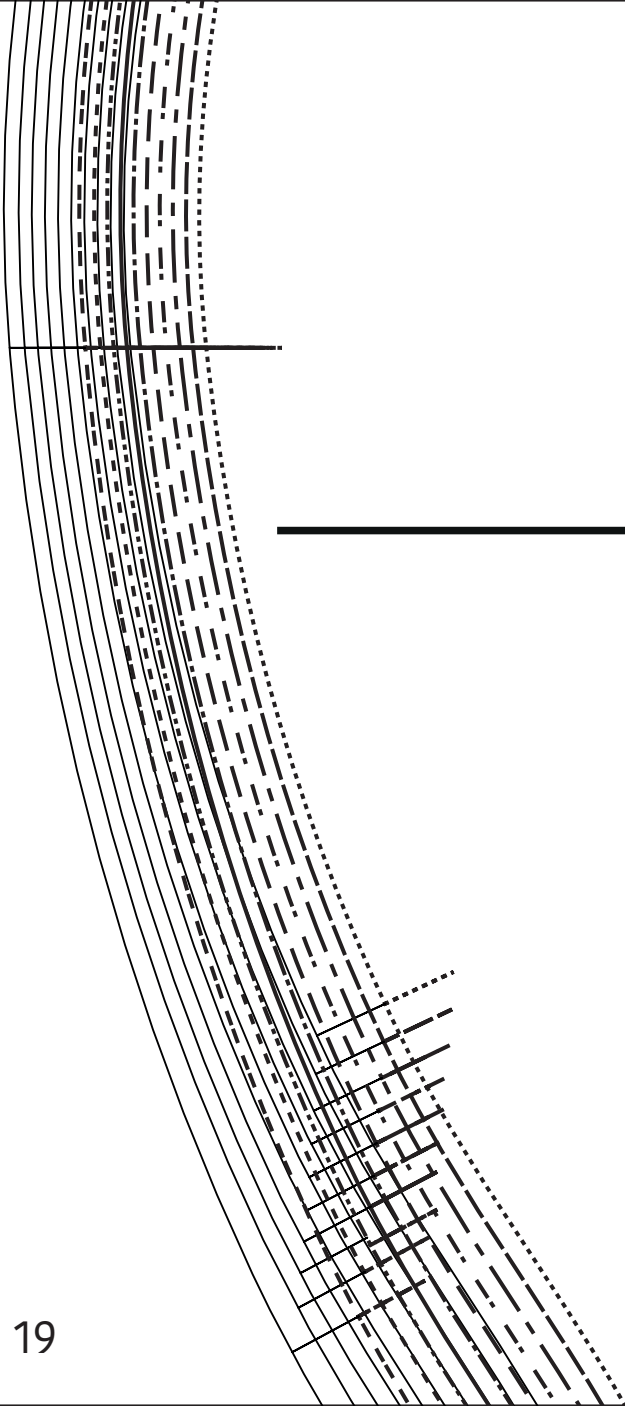

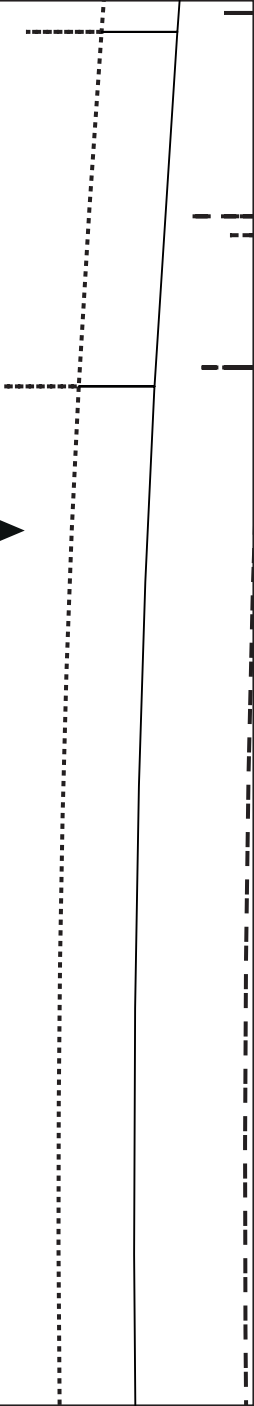

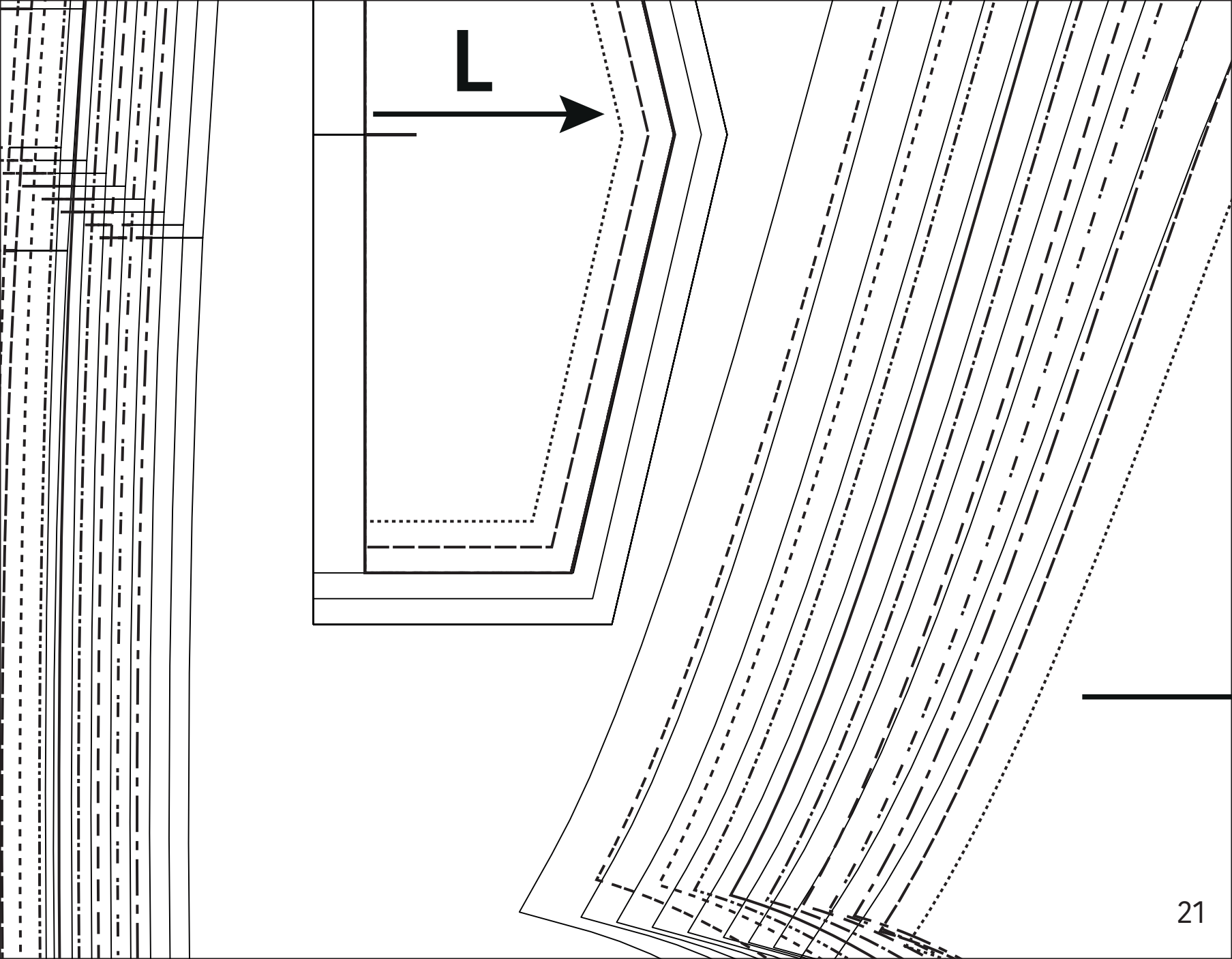

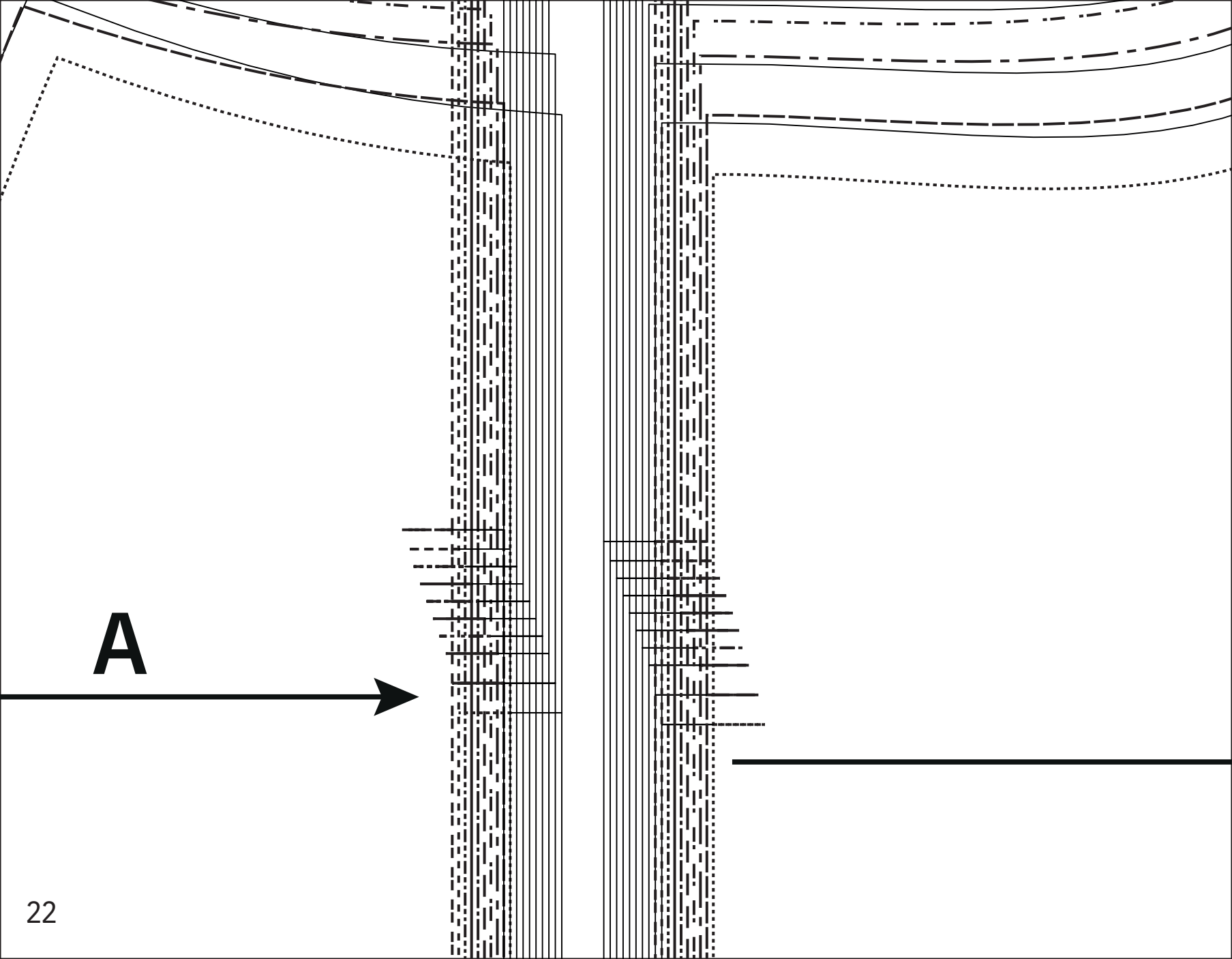

**A**

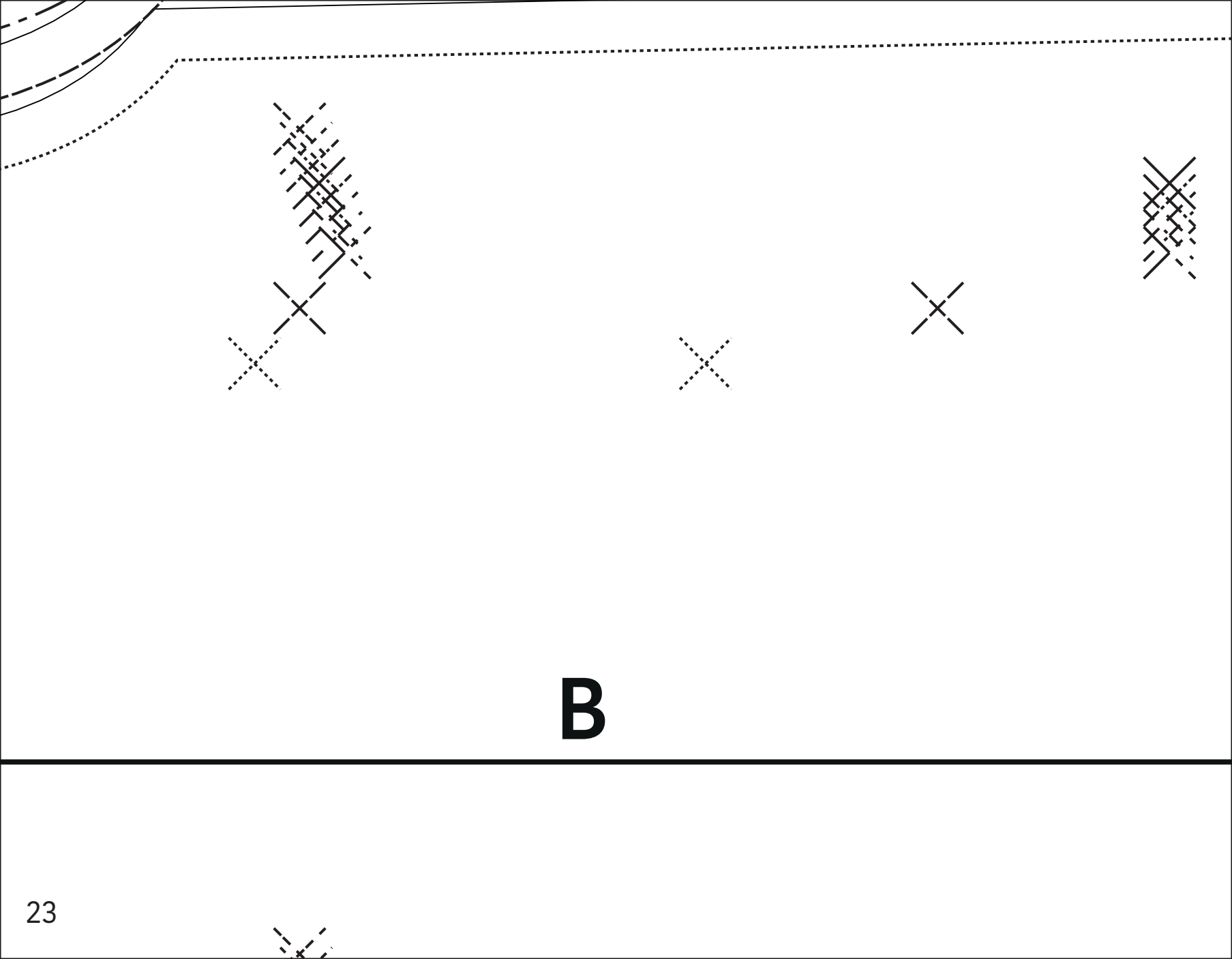

**B**

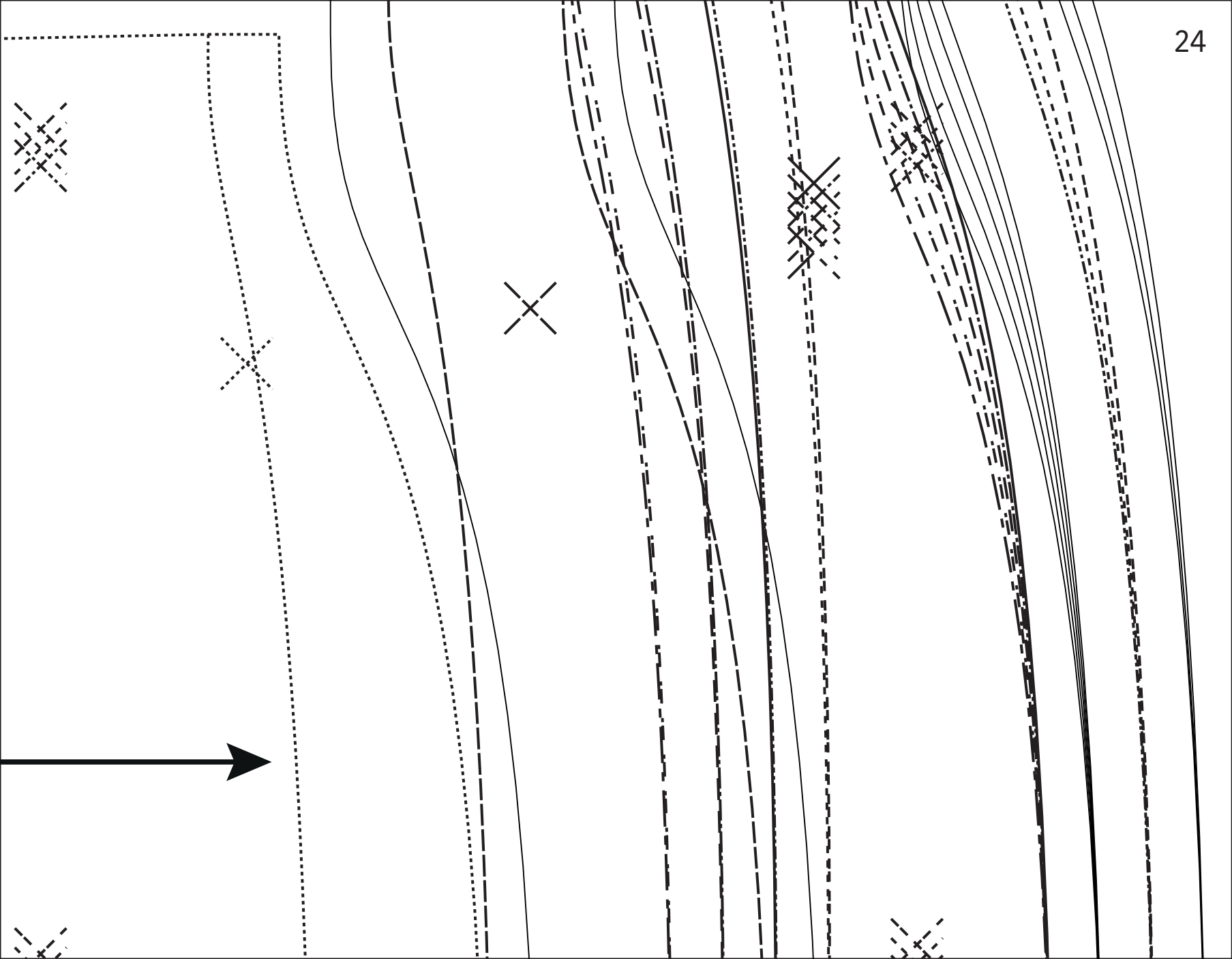



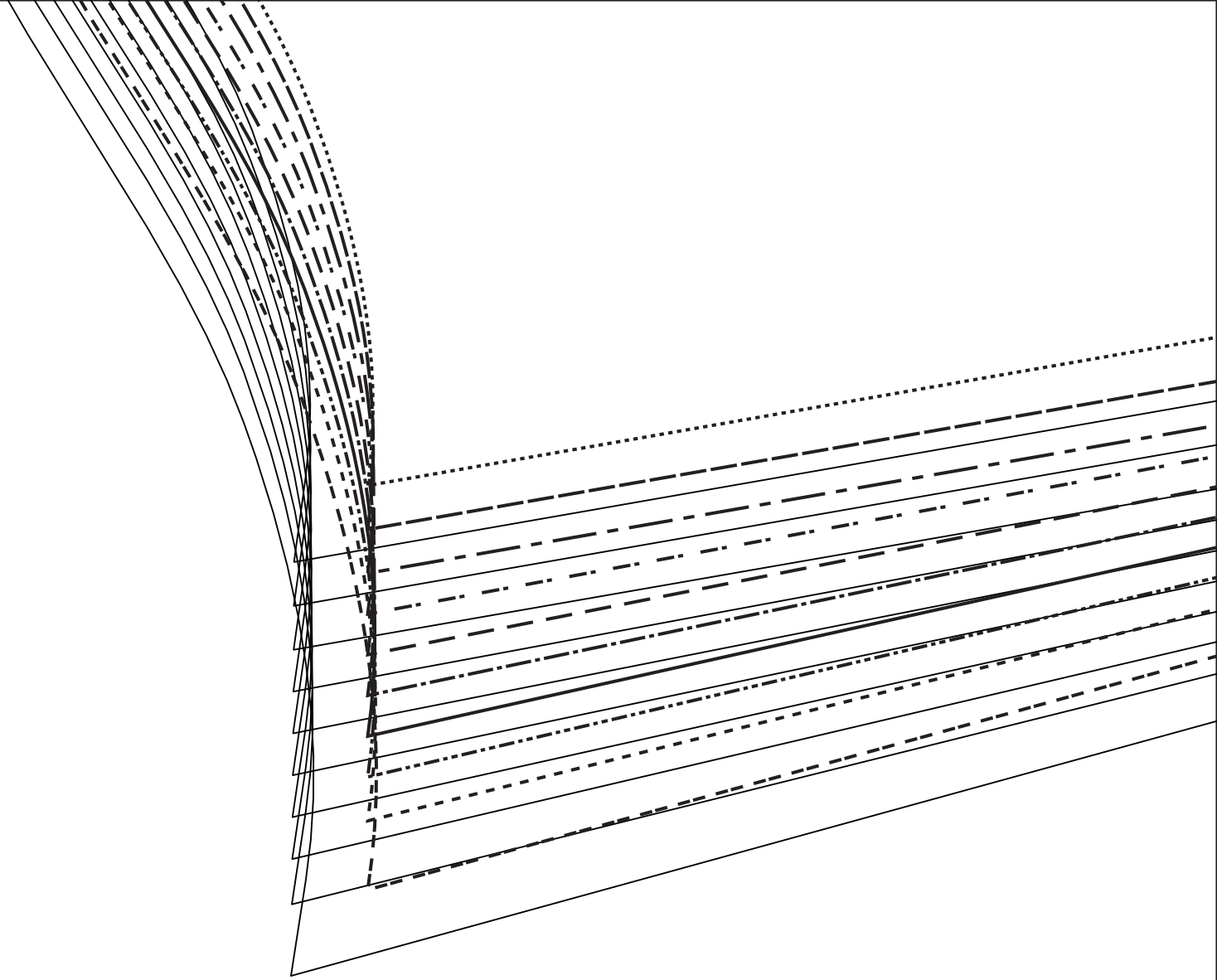

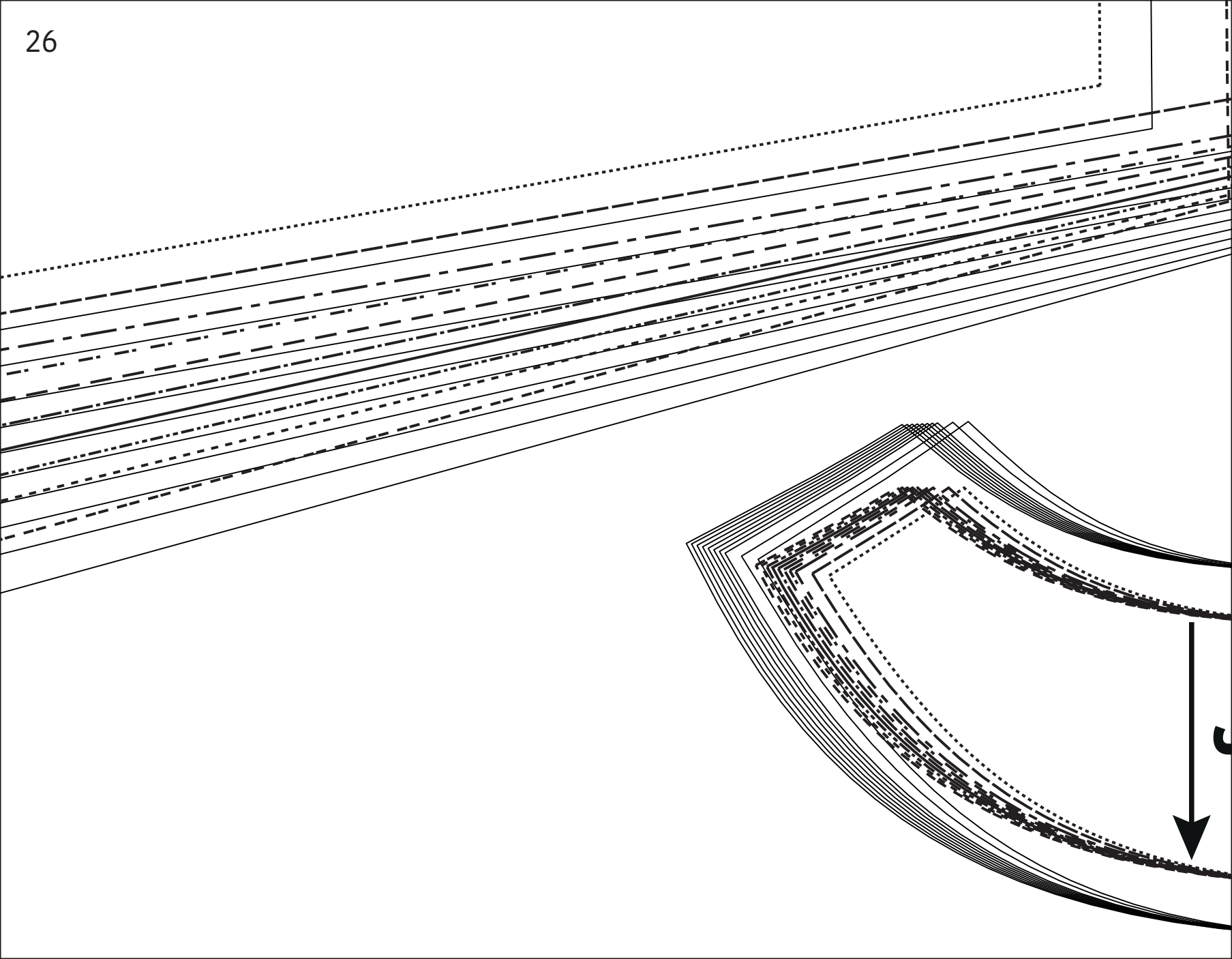

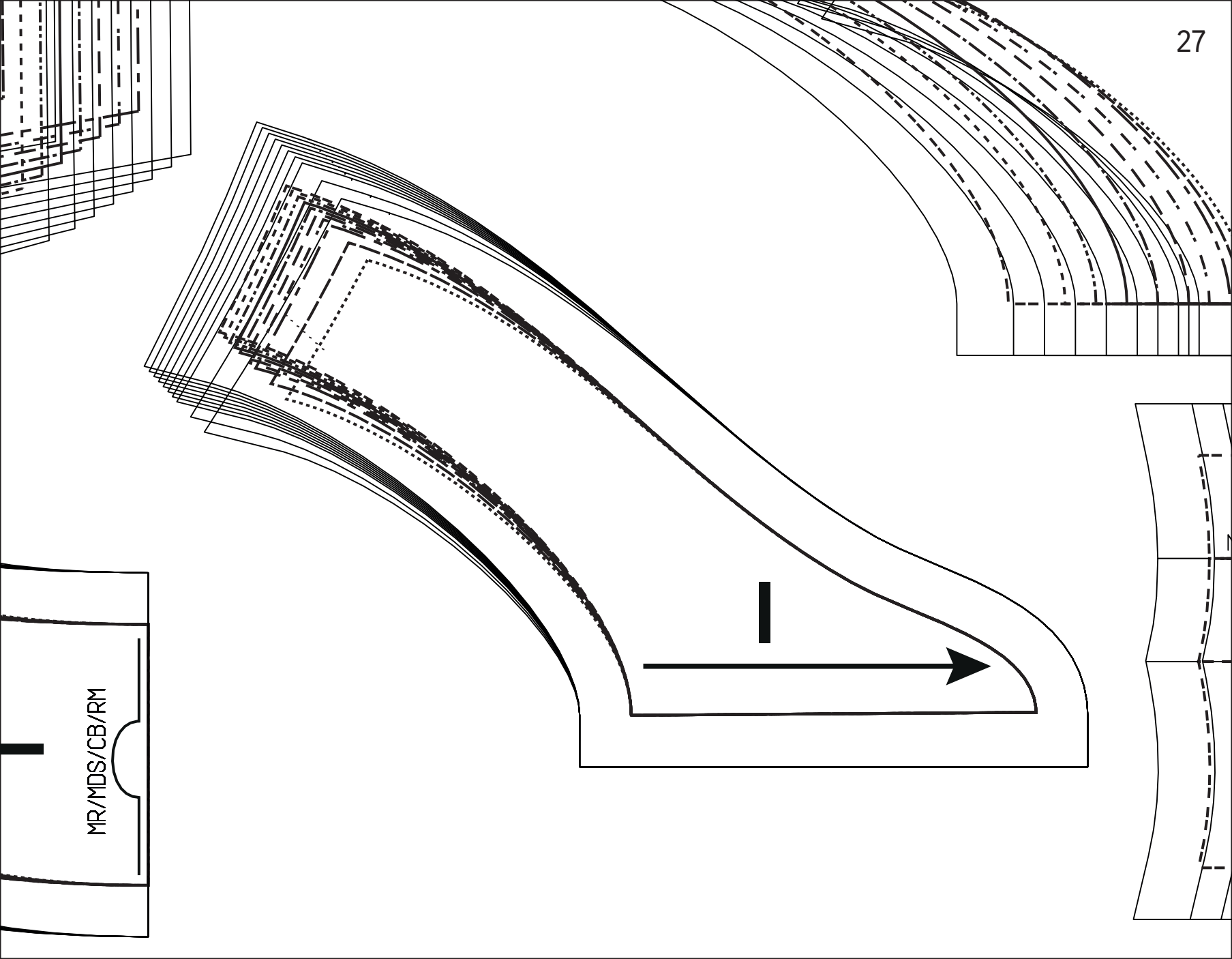

MR/MDS/CB/RM

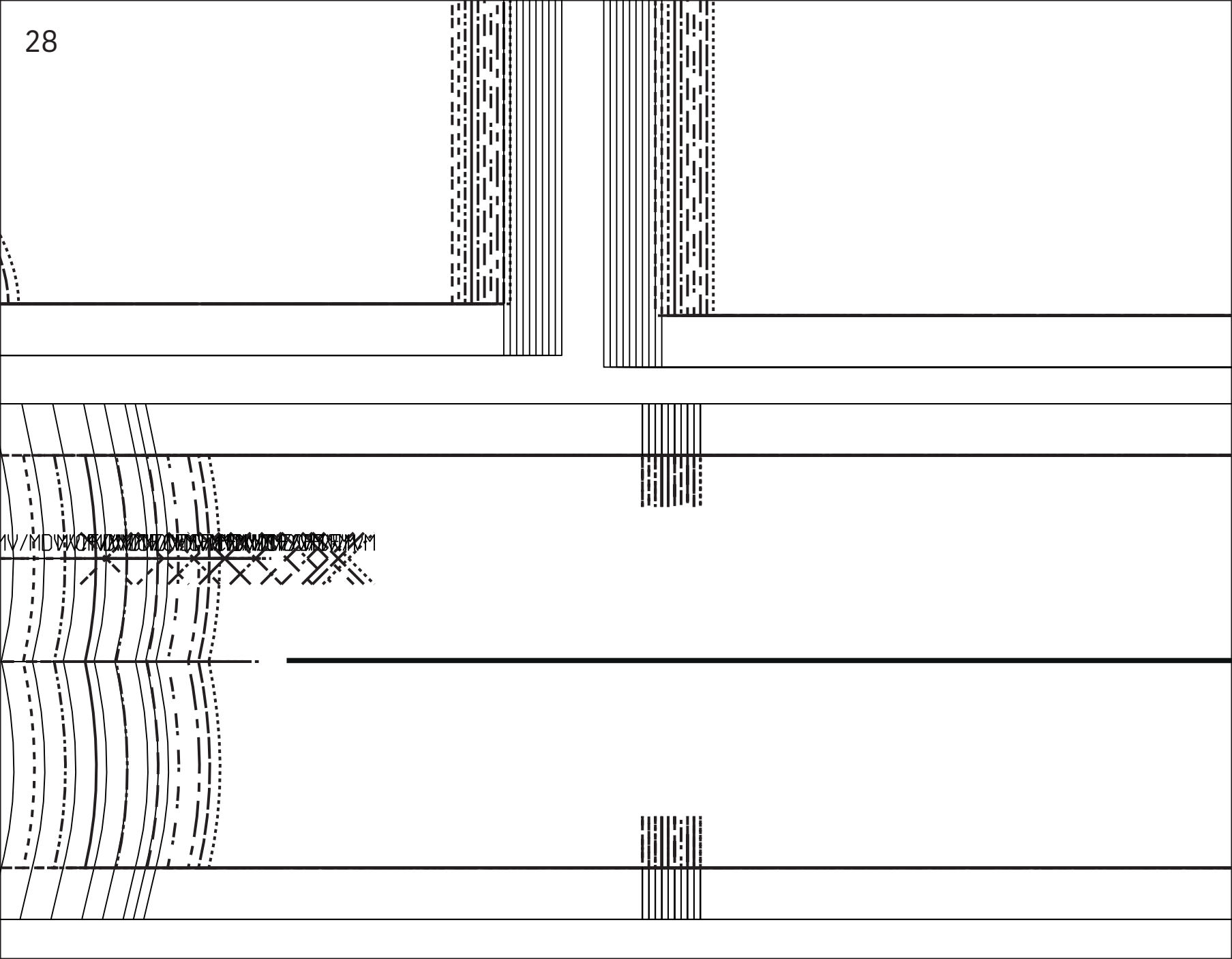



**E**

