

Titus

Trui / Pull / Jumper / Pullover

Maten / Tailles :

.....	XXS
-----	XS
-----	S
- - - - -	M
-----	L
-----	XL
-----	XXL

Patroondelen / Pièces du patron :

- A** voorpand / devant / front / Vorderteil
- B** rugpand / dos / back / Rückenteil
- C** mouw / manche / sleeve / Ärmel
- D** bovenkraag / dessus de col /
upper collar / Oberkragen
- D'** onderkraag / dessous de col /
lower collar / Unterkragen
- E** polsboord / bord manchette / cuff /
Ärmelmanschette
- F** zoomboord / liseré ourlet / cuffs /
Saumbund

Patroonschema / Schéma du Patron / Pattern Diagram / Übersichtsplan zum Zusammenkleben

1	2	3	4	5	6
7	8	9	10	11	12
13	14	15	16	17	18
19	20	21	22	23	24
25	26	27			

Controlevierkant / Carré de controle / Test square / Kontrollquadrat

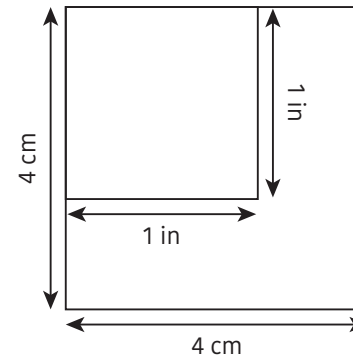

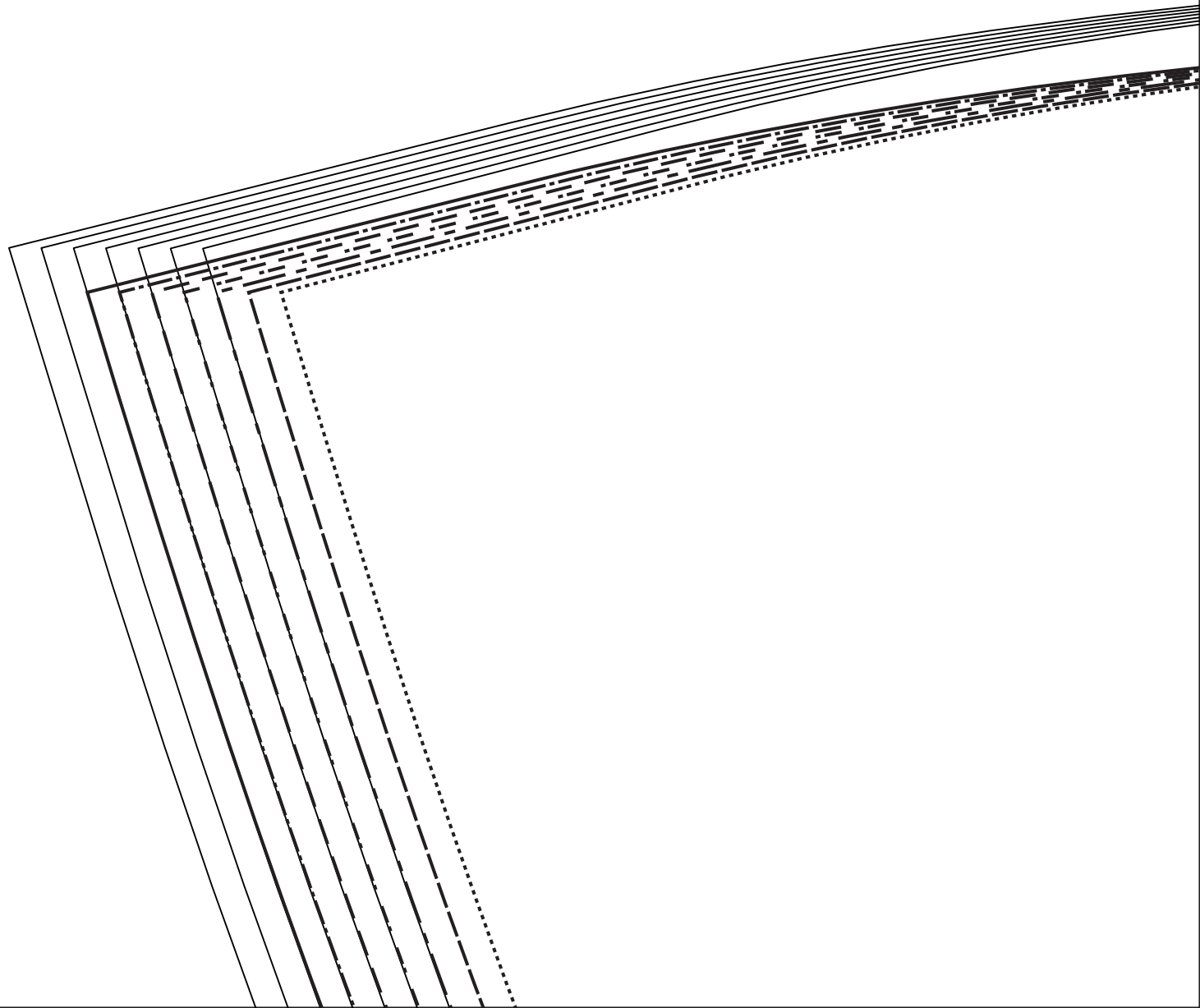

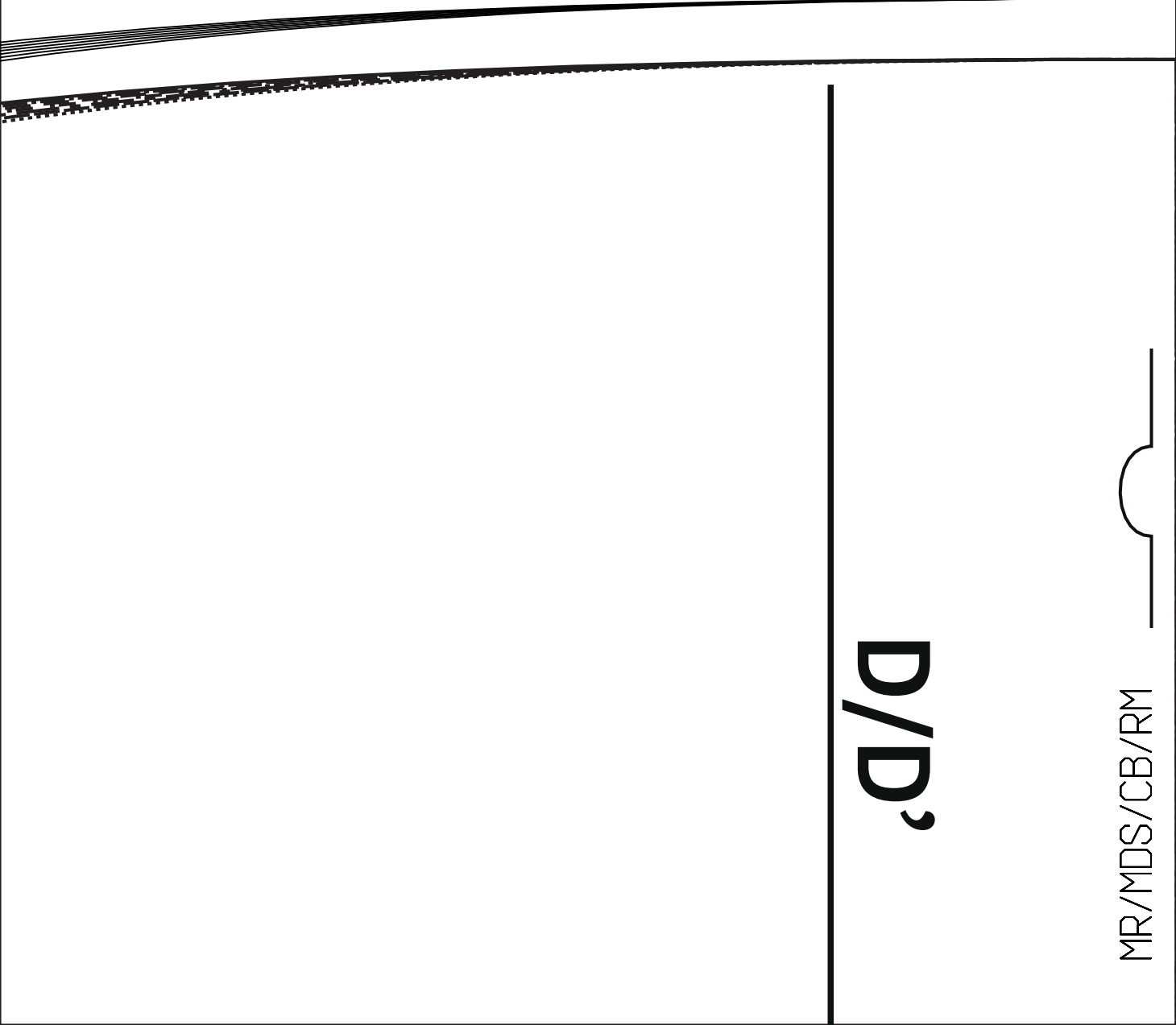

MR/MDS/CB/RM



D/D'



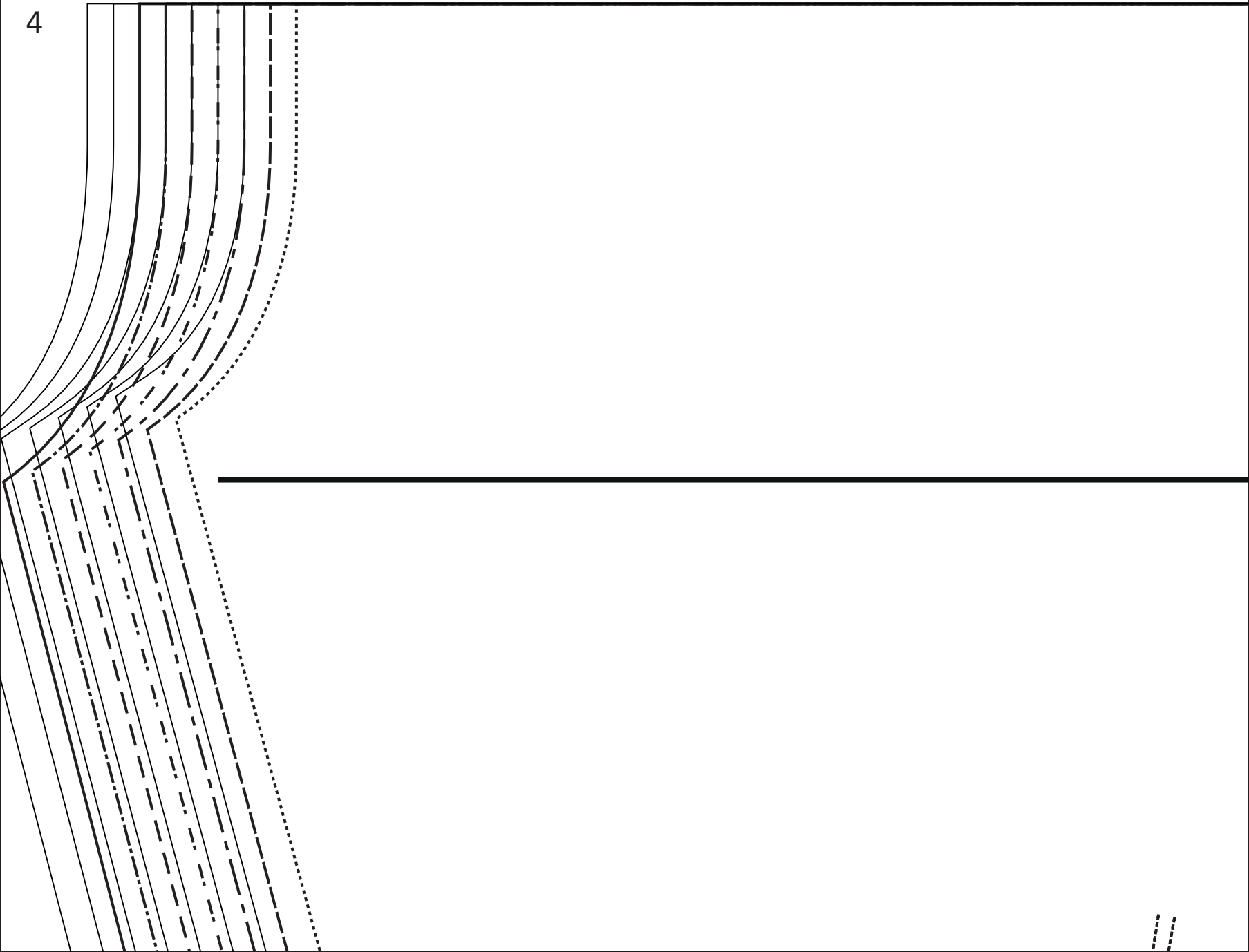

MR/MDS/CB/RM



B

6



--	--	--	--

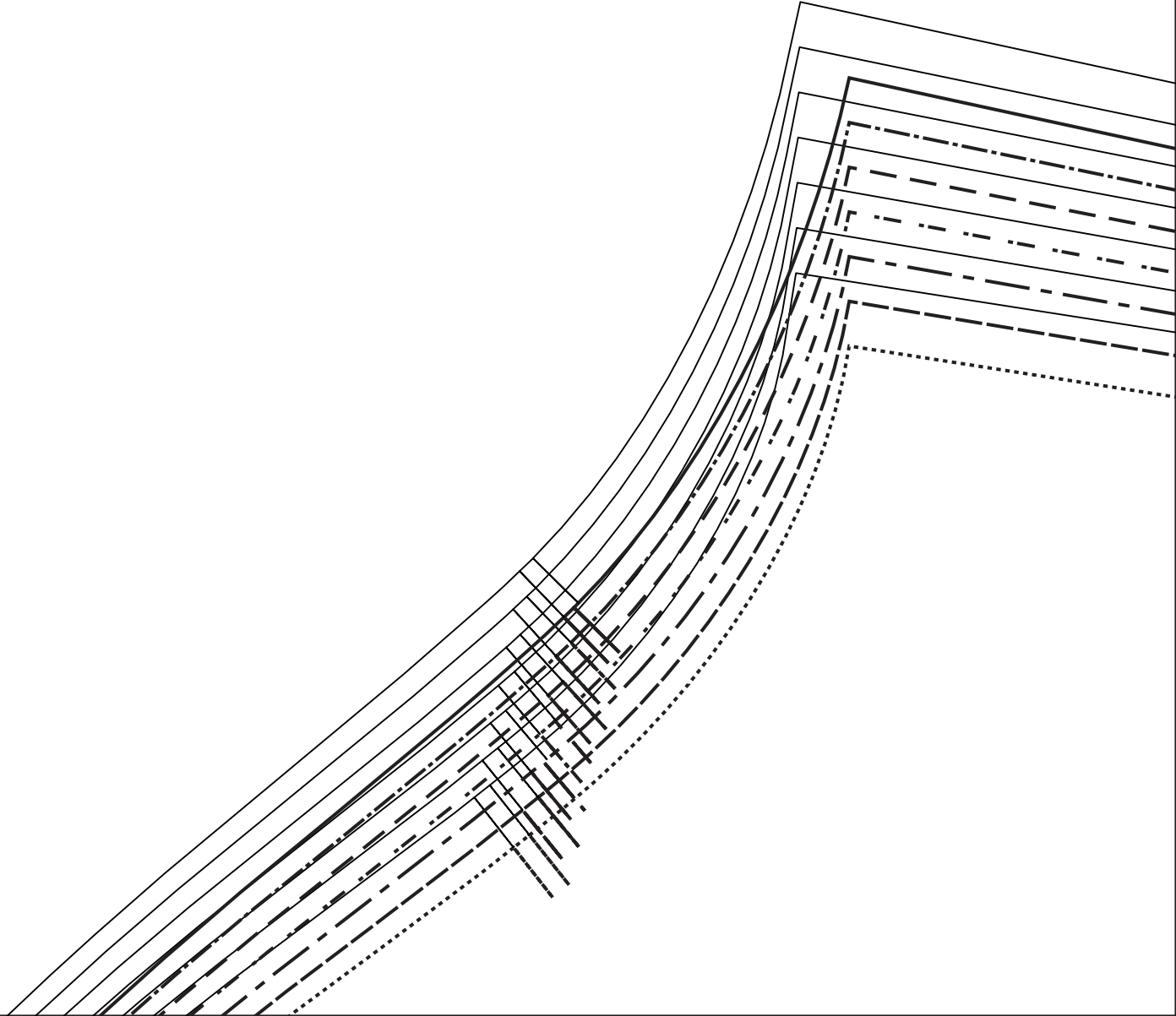

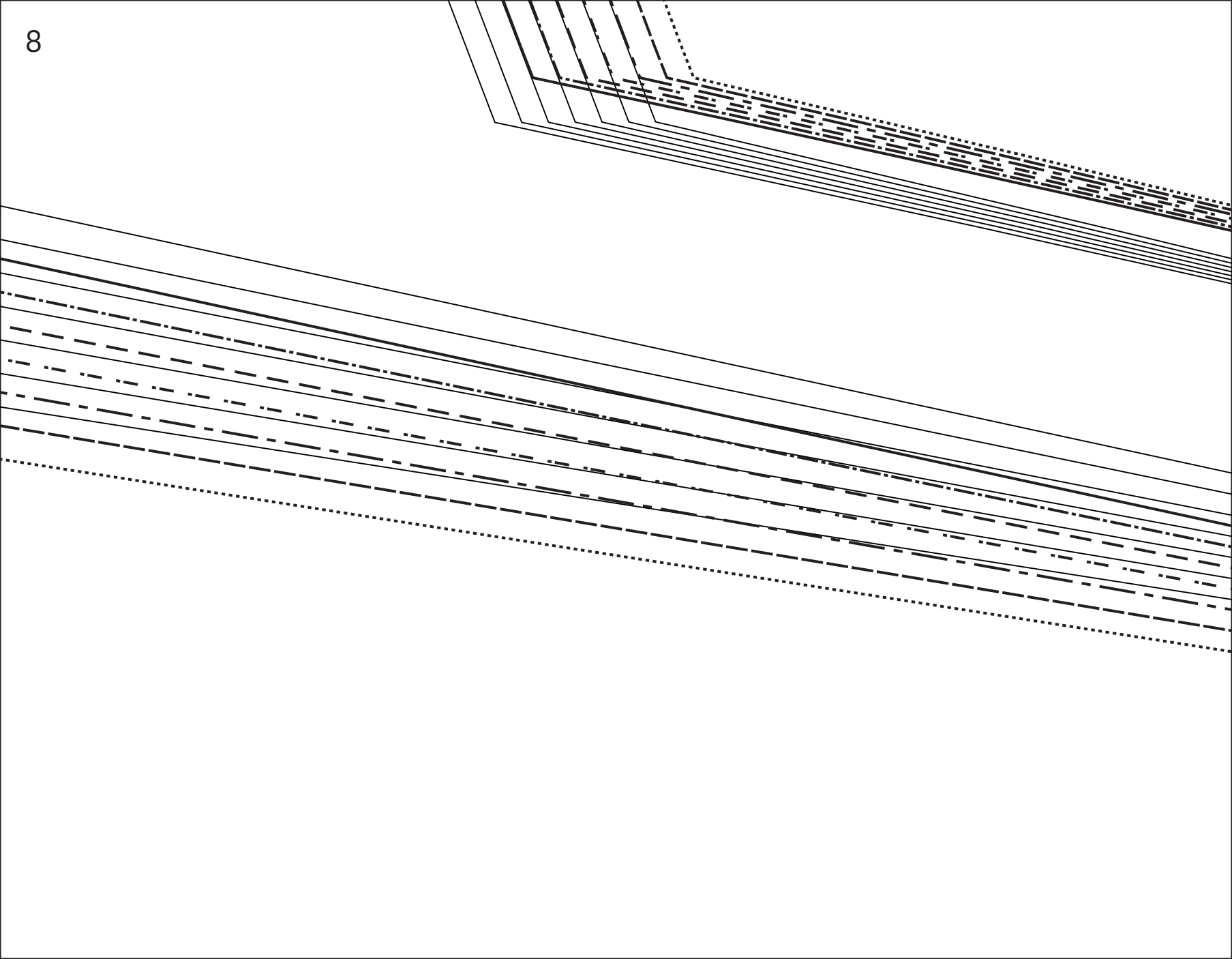

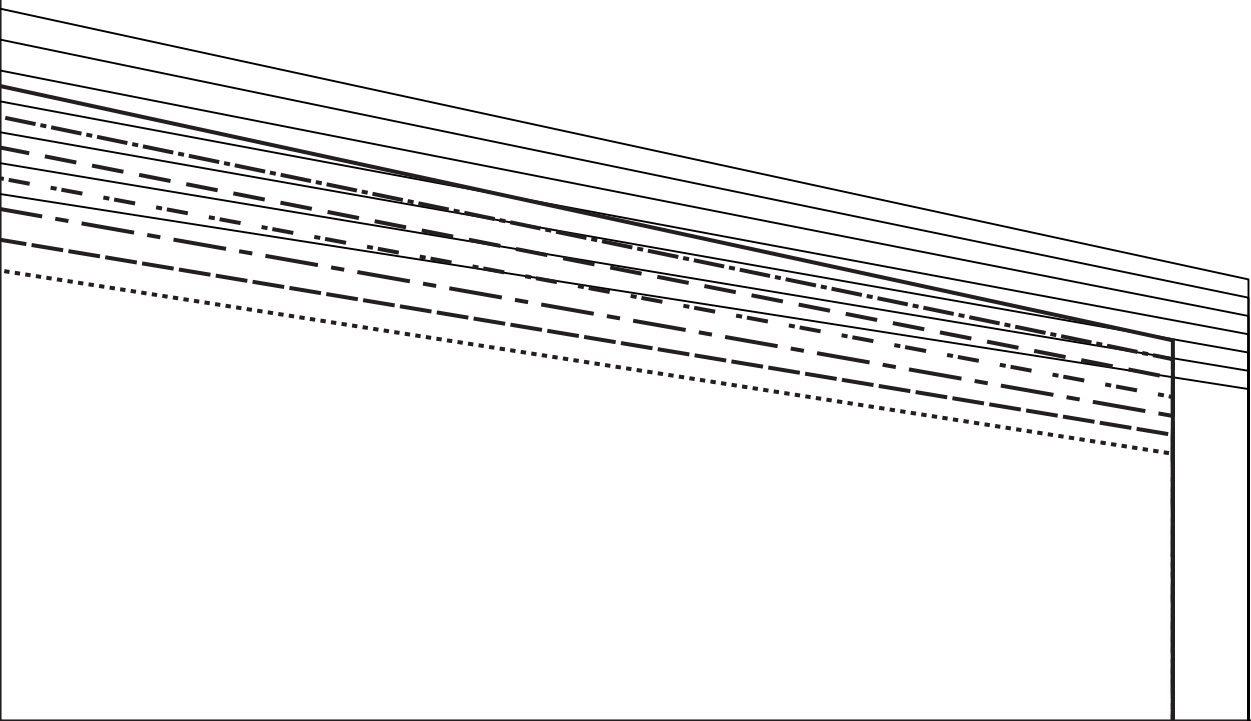
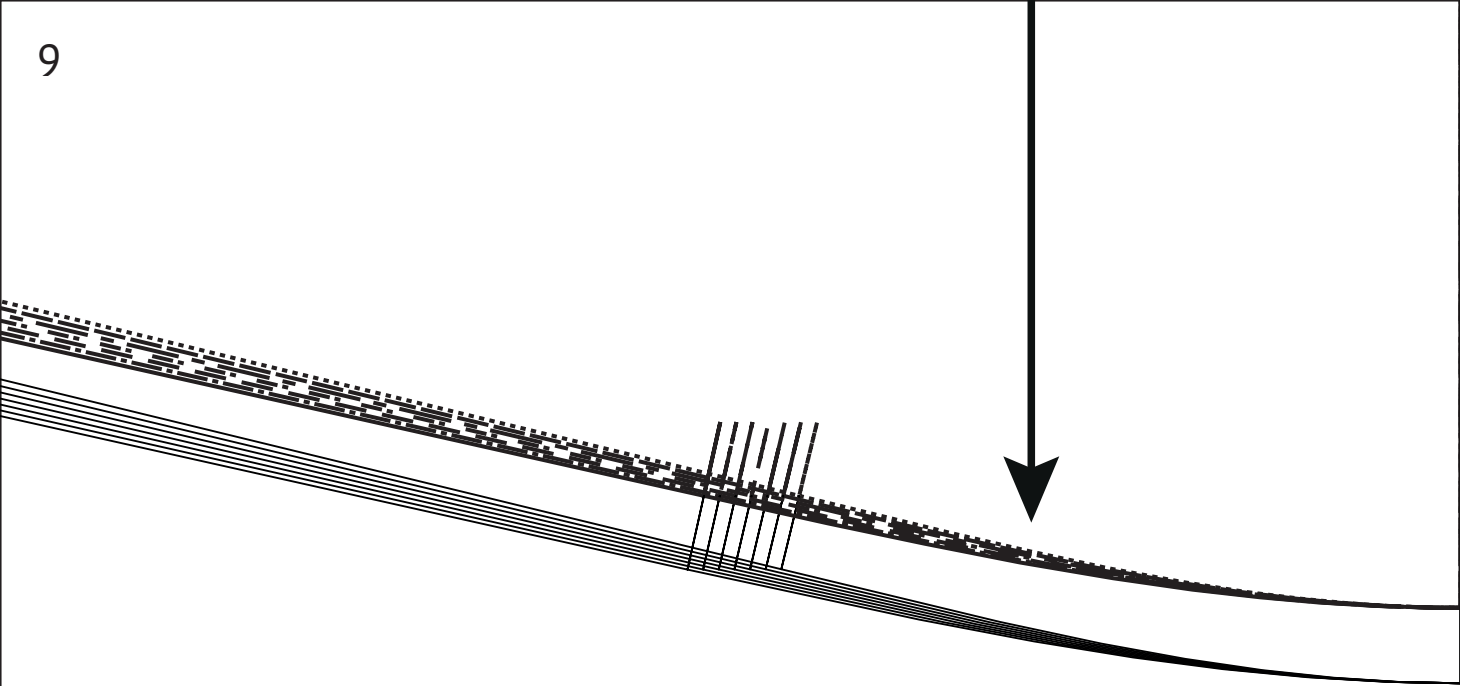

10

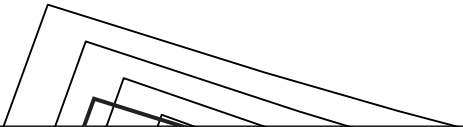
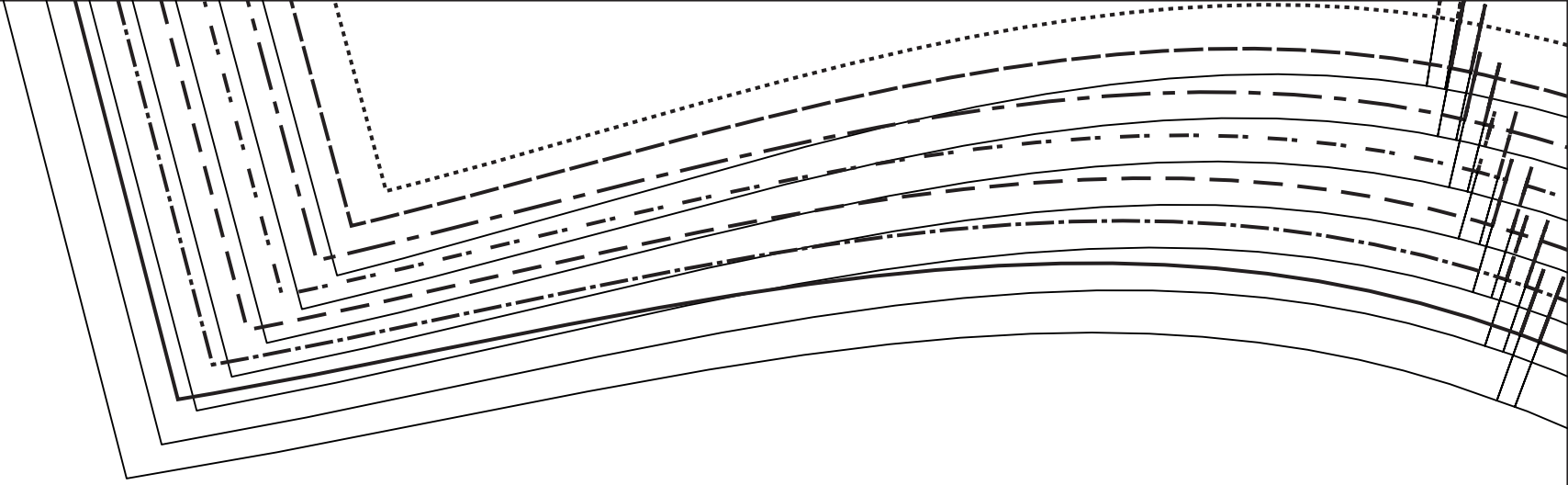

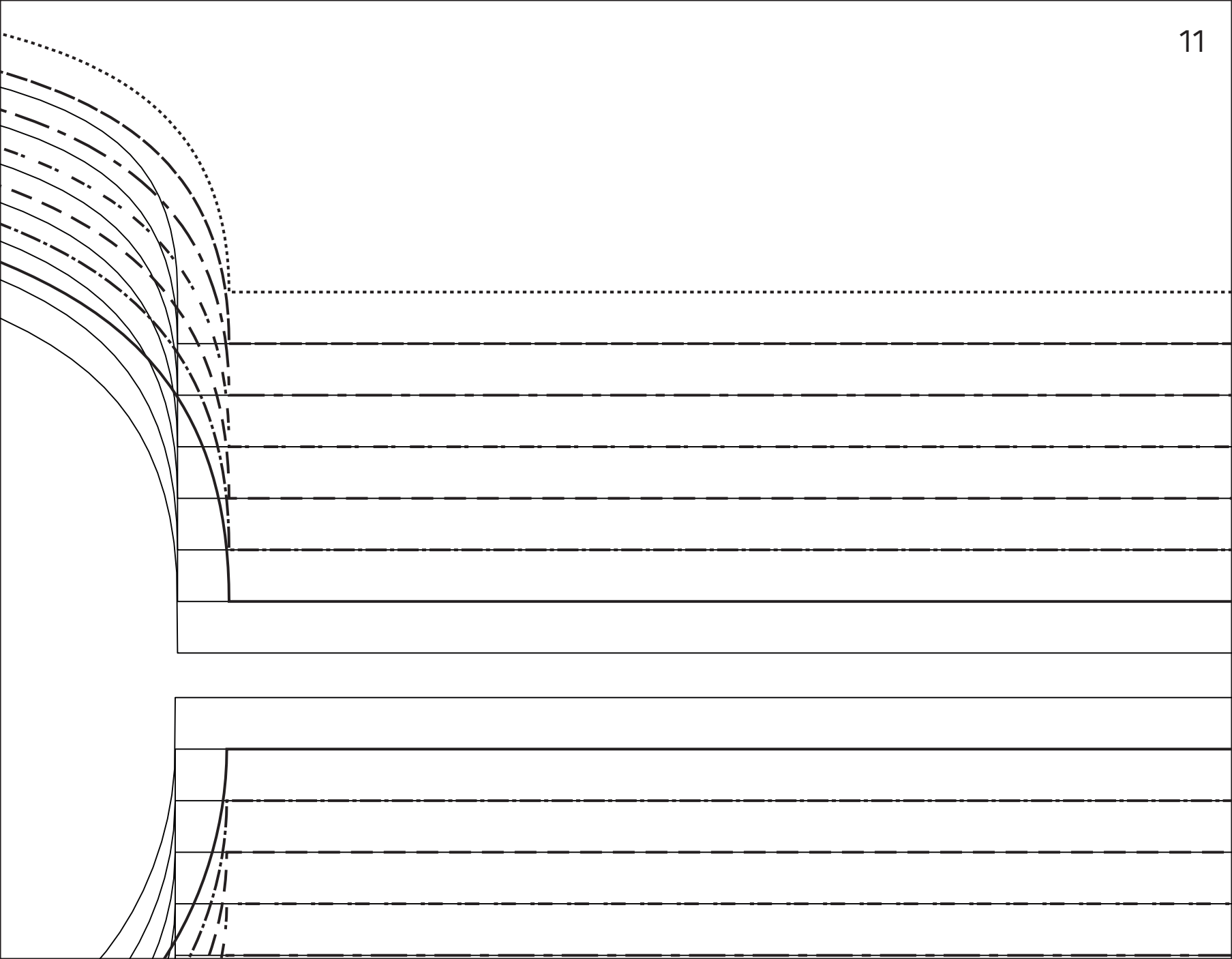

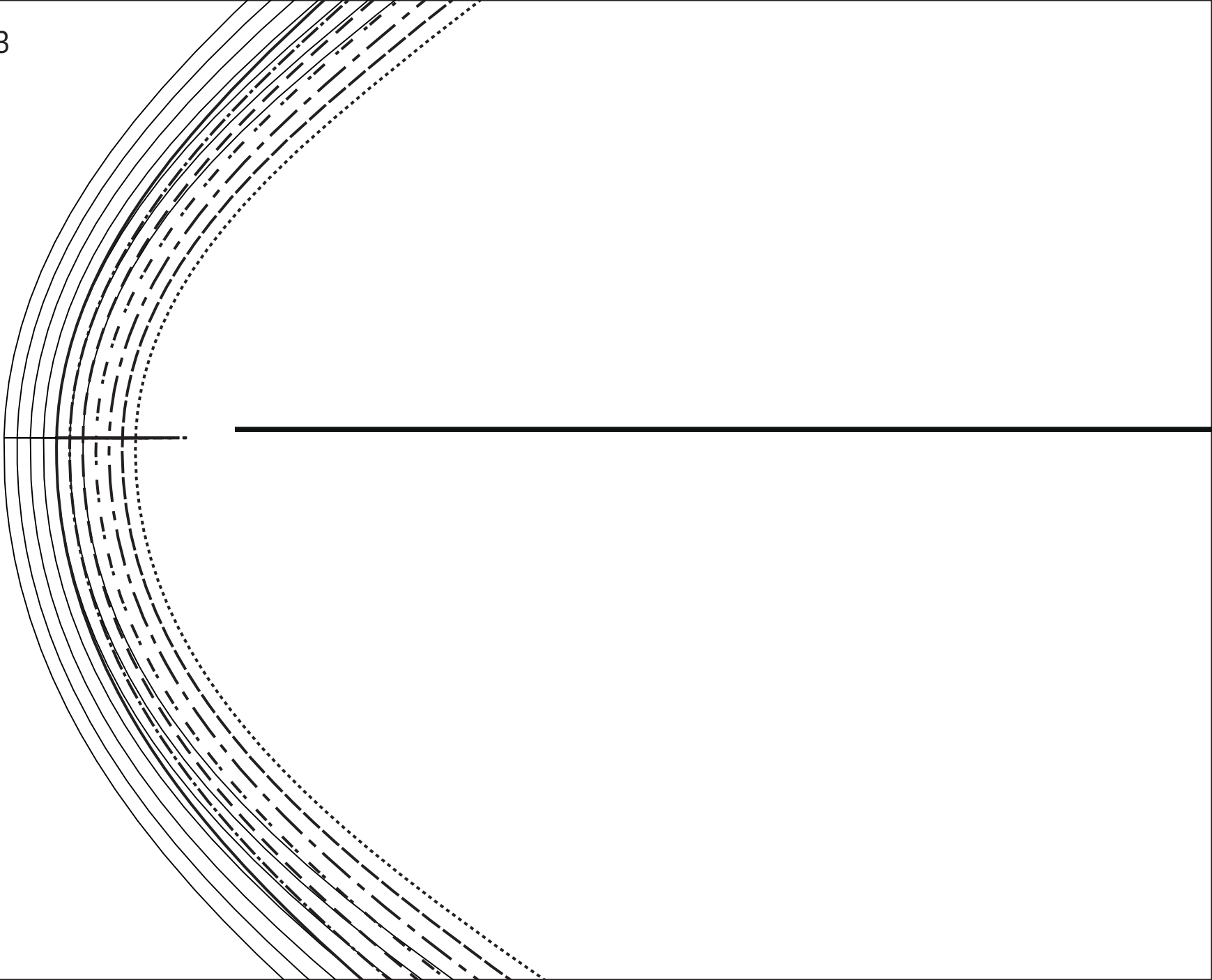

C

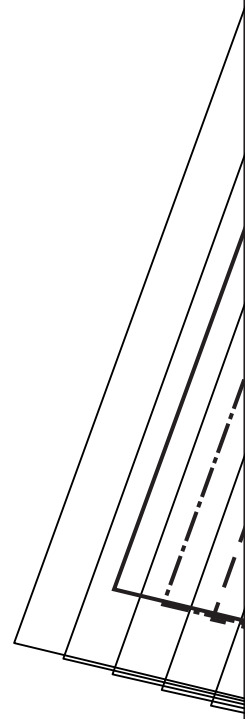

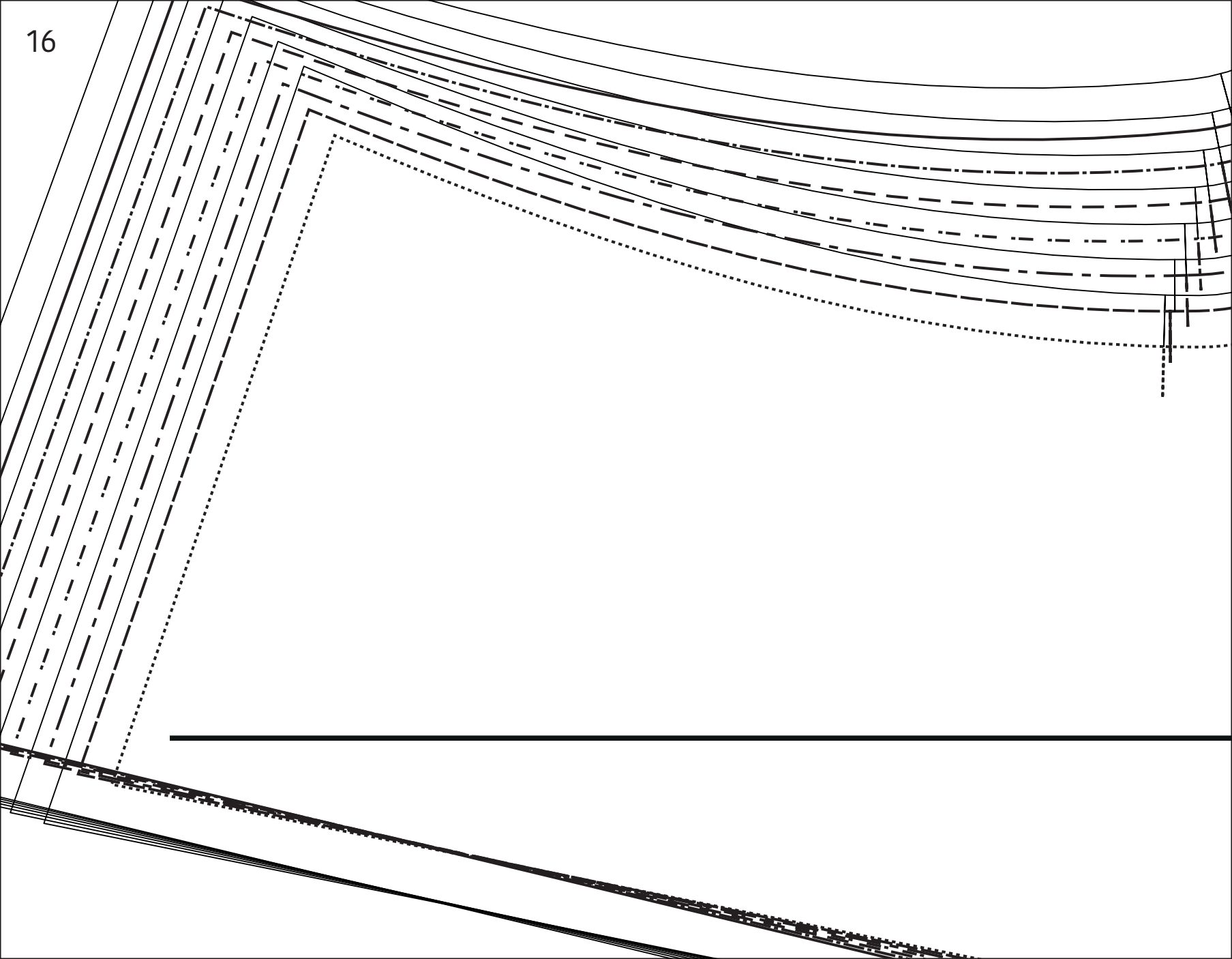

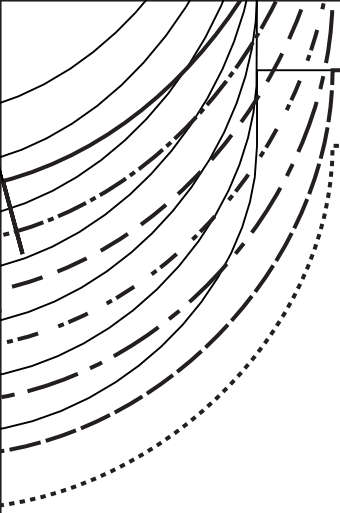

A

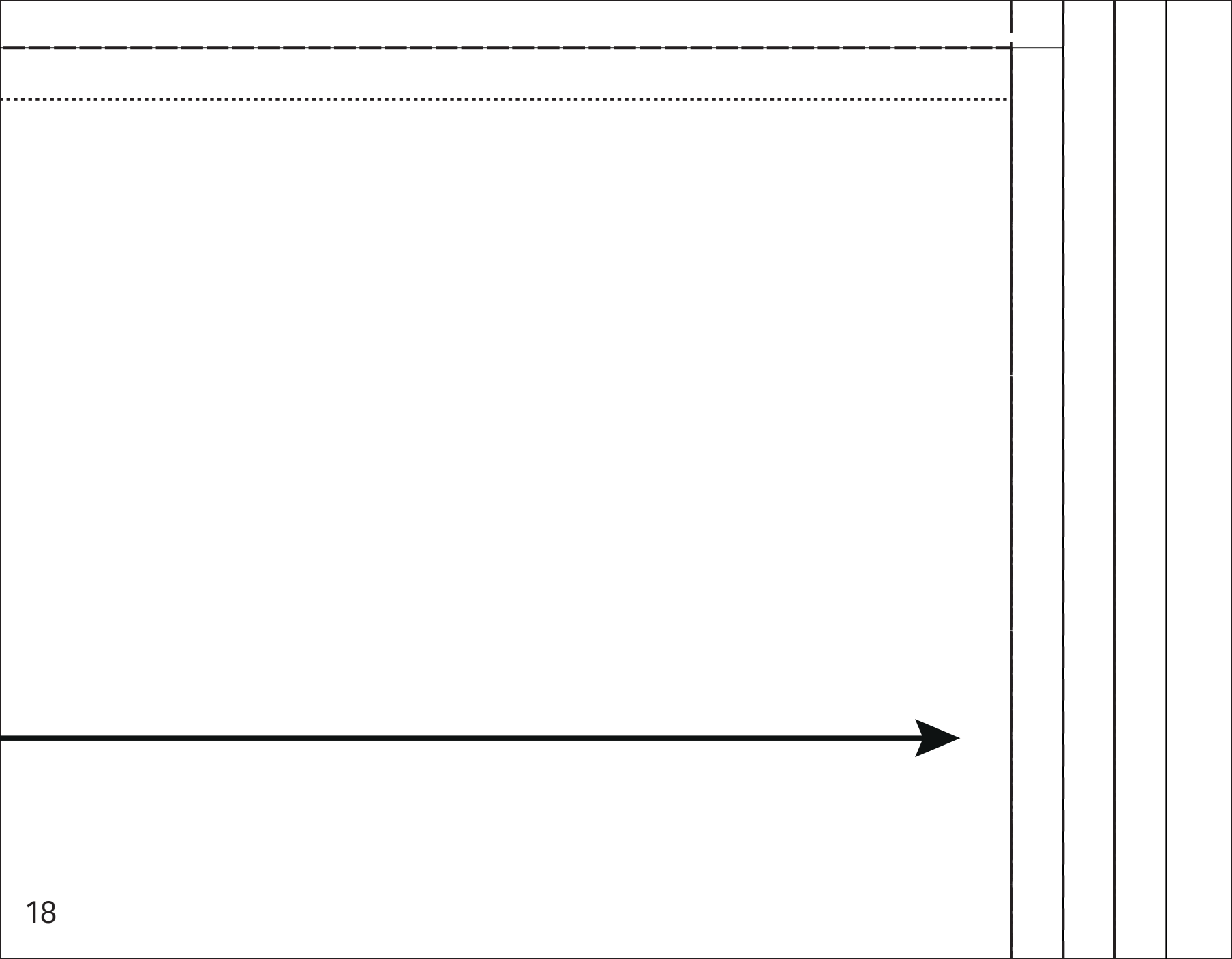

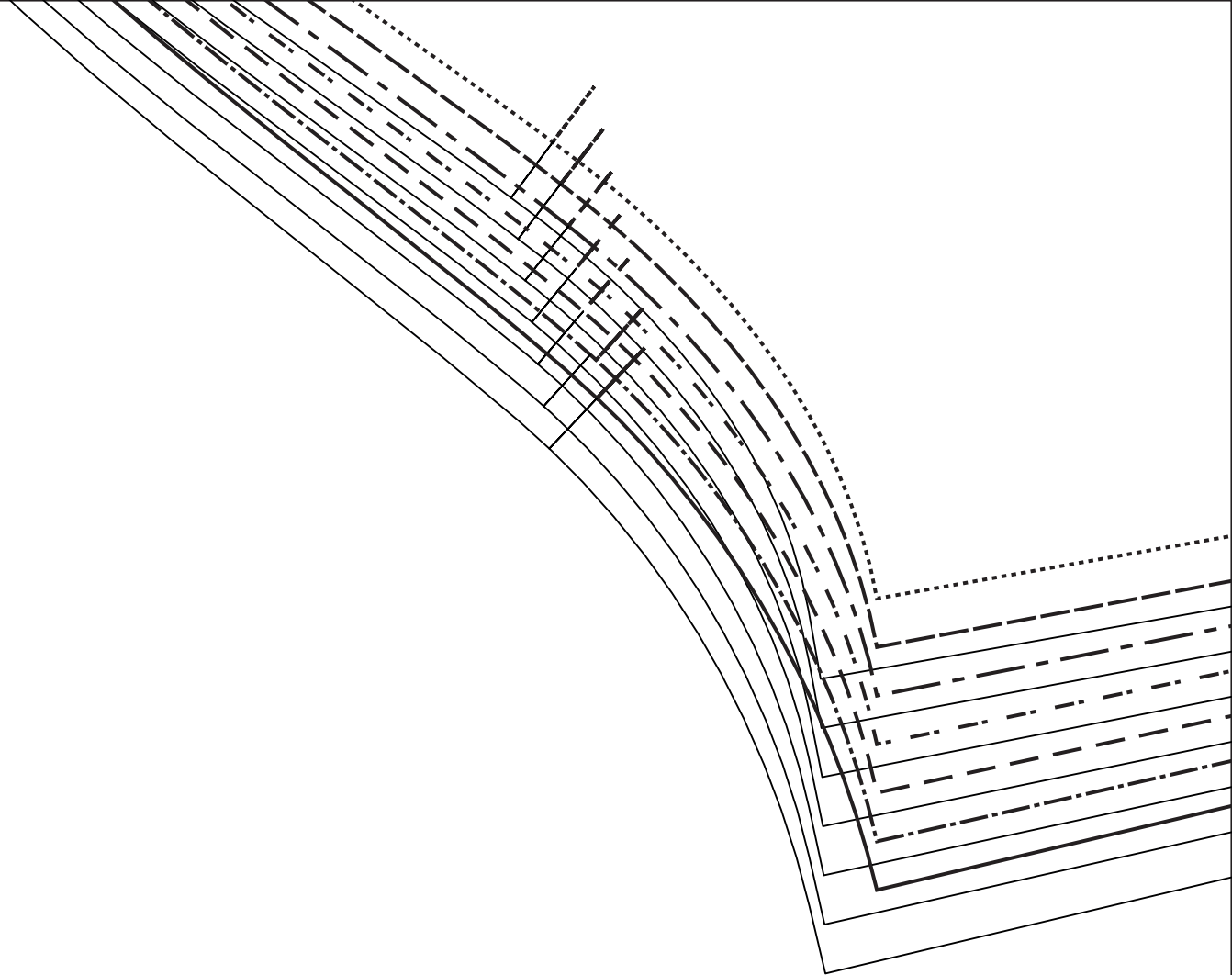

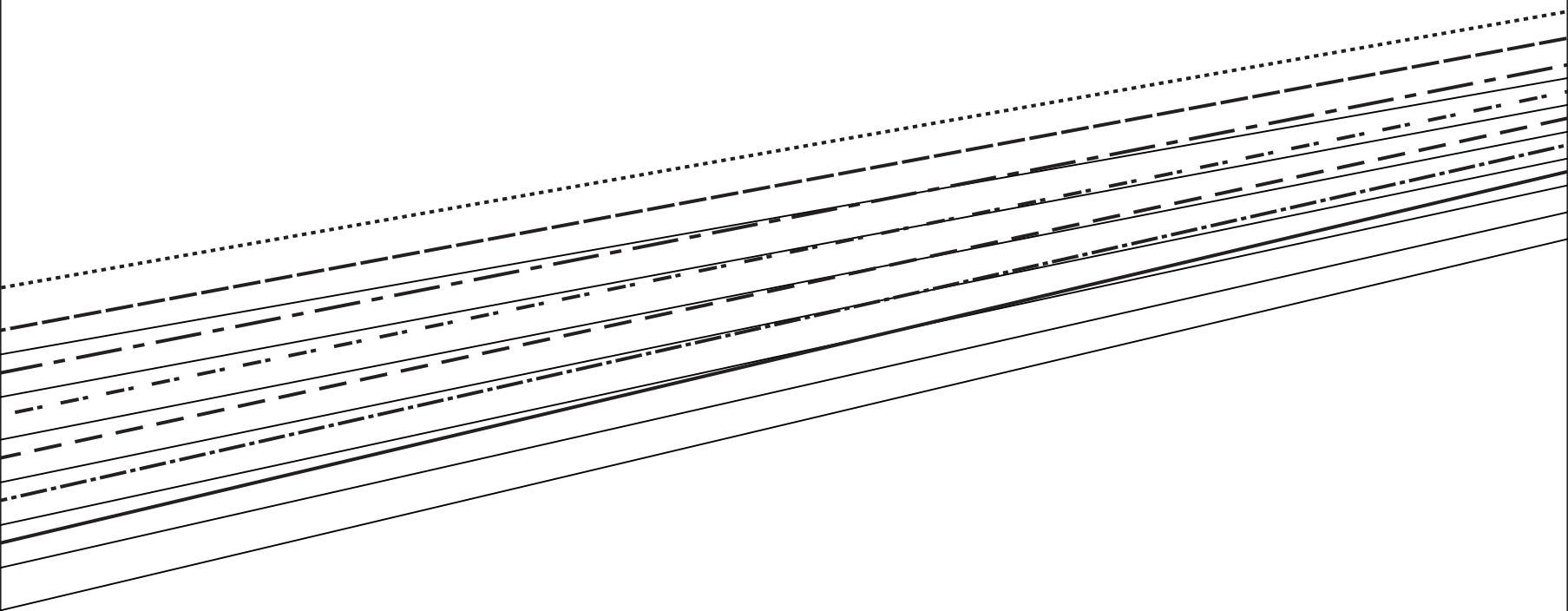

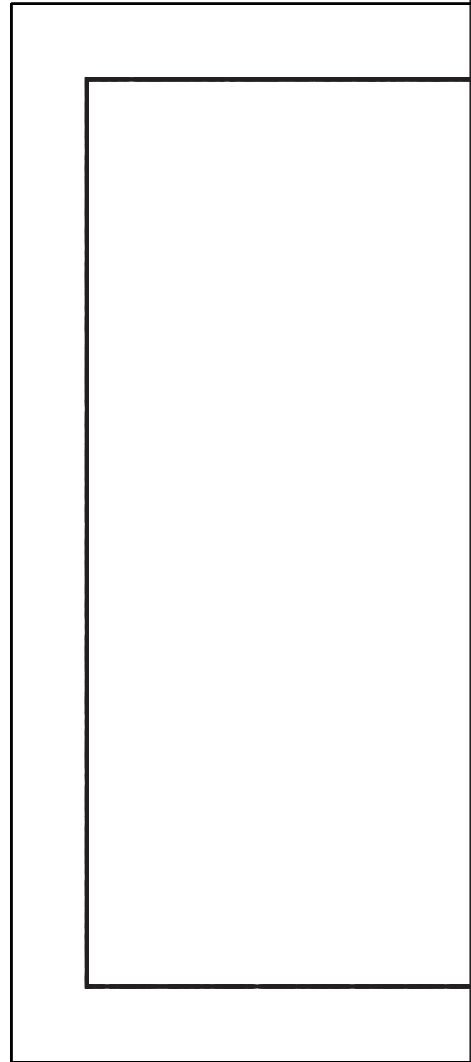
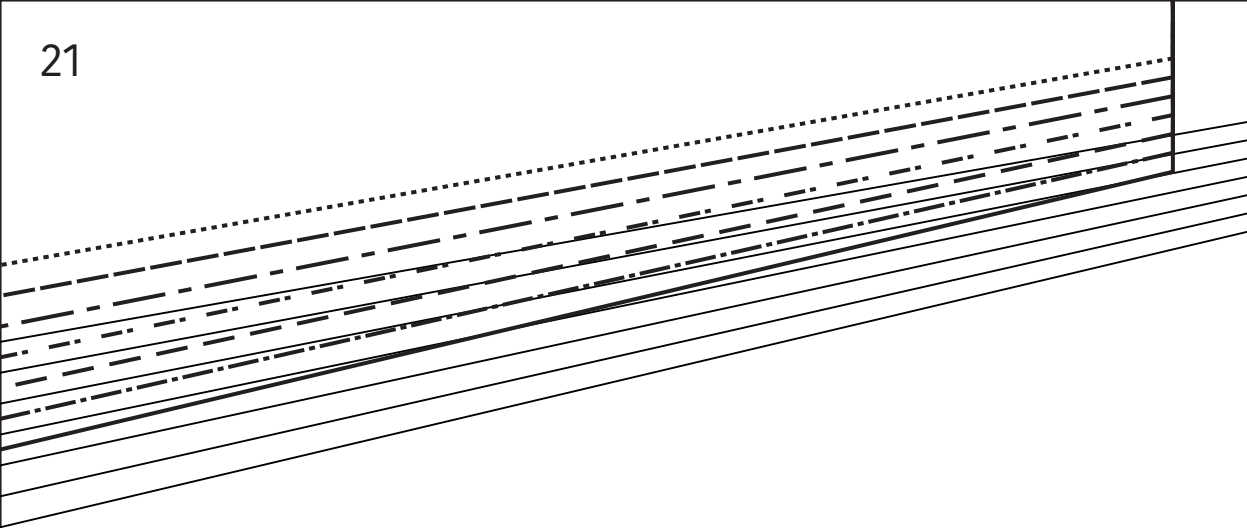

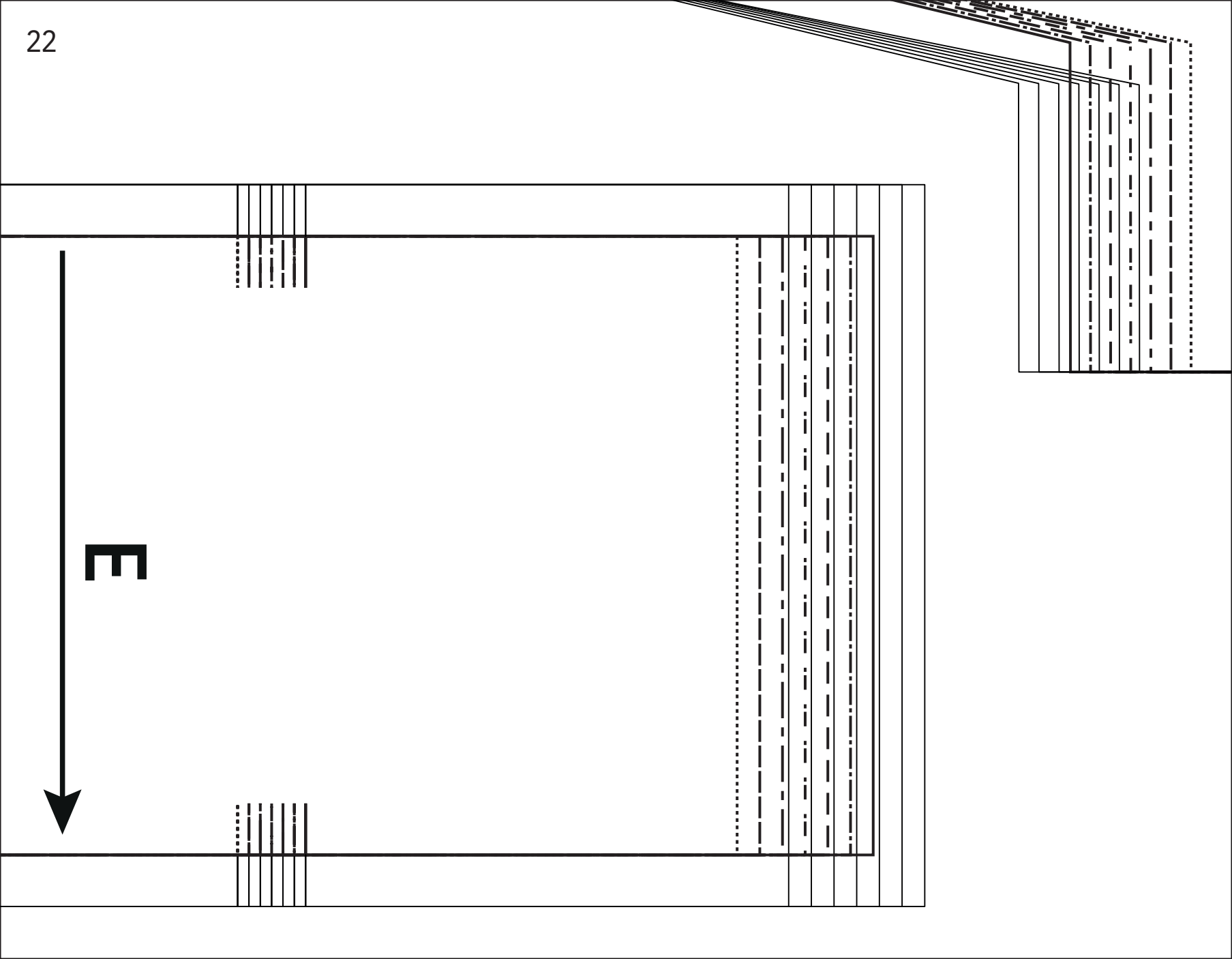

 MV/MDV/CF/VM

--	--	--	--

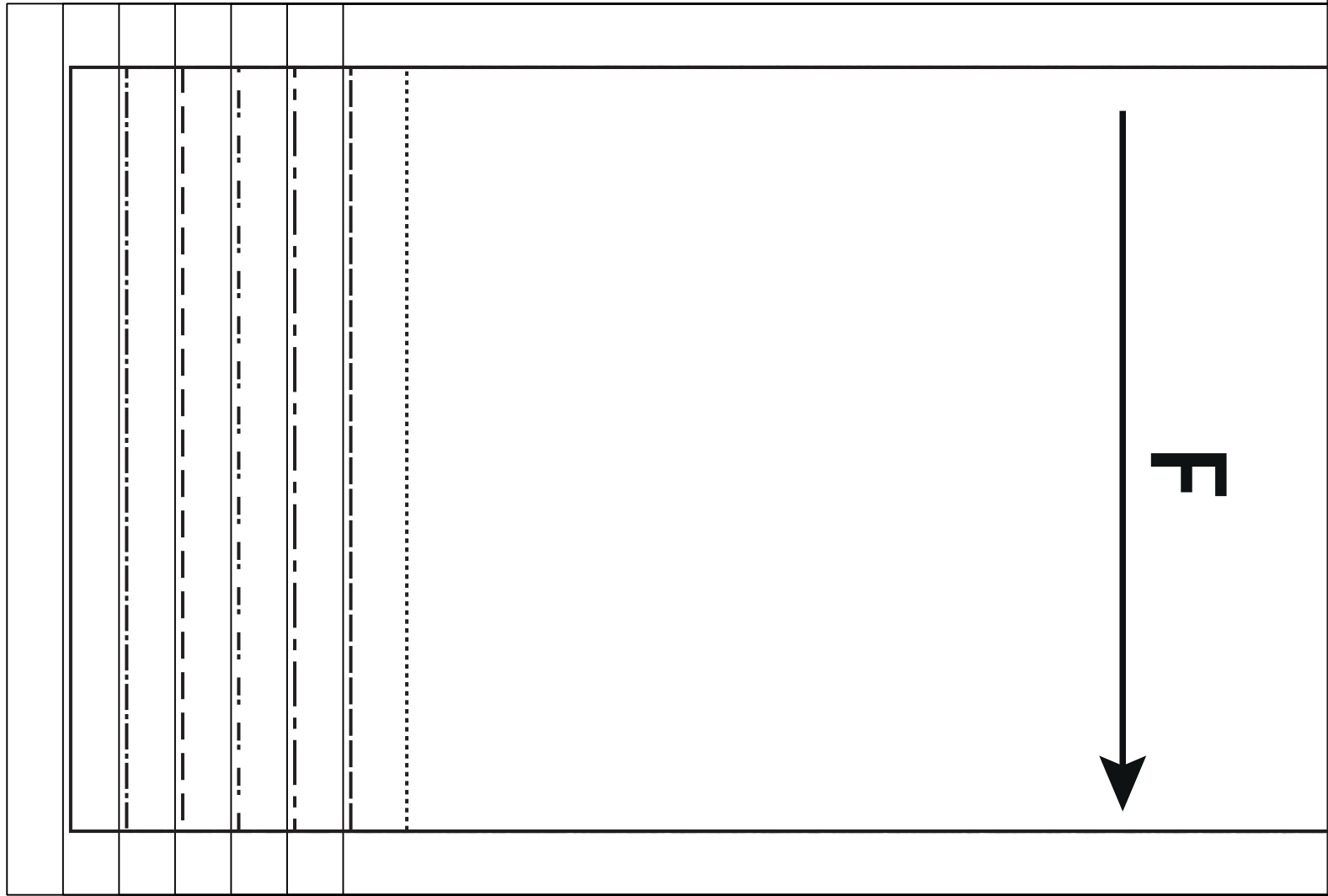

--	--

--	--

--	--

--	--

