

# Becky

Jurk / Robe /  
Dress / Kleid



Maten / Tailles / Sizes / Größen:

-----	34
-----	36
-----	38
-----	40
—————	42
-----	44
-----	46
-----	48
-----	50
-----	52
-----	54
-----	56

Patroondelen / Pièces du patron /  
Pattern pieces / Schnittteile:

- A** voorpand / devant / front panel /  
Vorderteil
- B** rugpand / dos / back panel /  
Rückenteil
- C** mouwboord / bord manchette /  
cuffs / Manschette
- D** beleg VP / parementure DV /  
facing FP / Besatz VT
- E** beleg RP / parementure DS /  
facing BP / Besatz RT
- F** zak / poche / pocket / Tasche

Patroonschema / Schéma du Patron / Pattern Diagram /  
Übersichtsplan zum Zusammenkleben

1	2	3	4	5	6
7	8	9	10	11	12
13	14	15	16	17	18
19	20	21	22	23	24
25	26	27	28	29	30
	32	33	34	35	36
	38	39	40	41	42

Controlevierkant / Carré de controle  
/ Test square / Kontrollquadrat

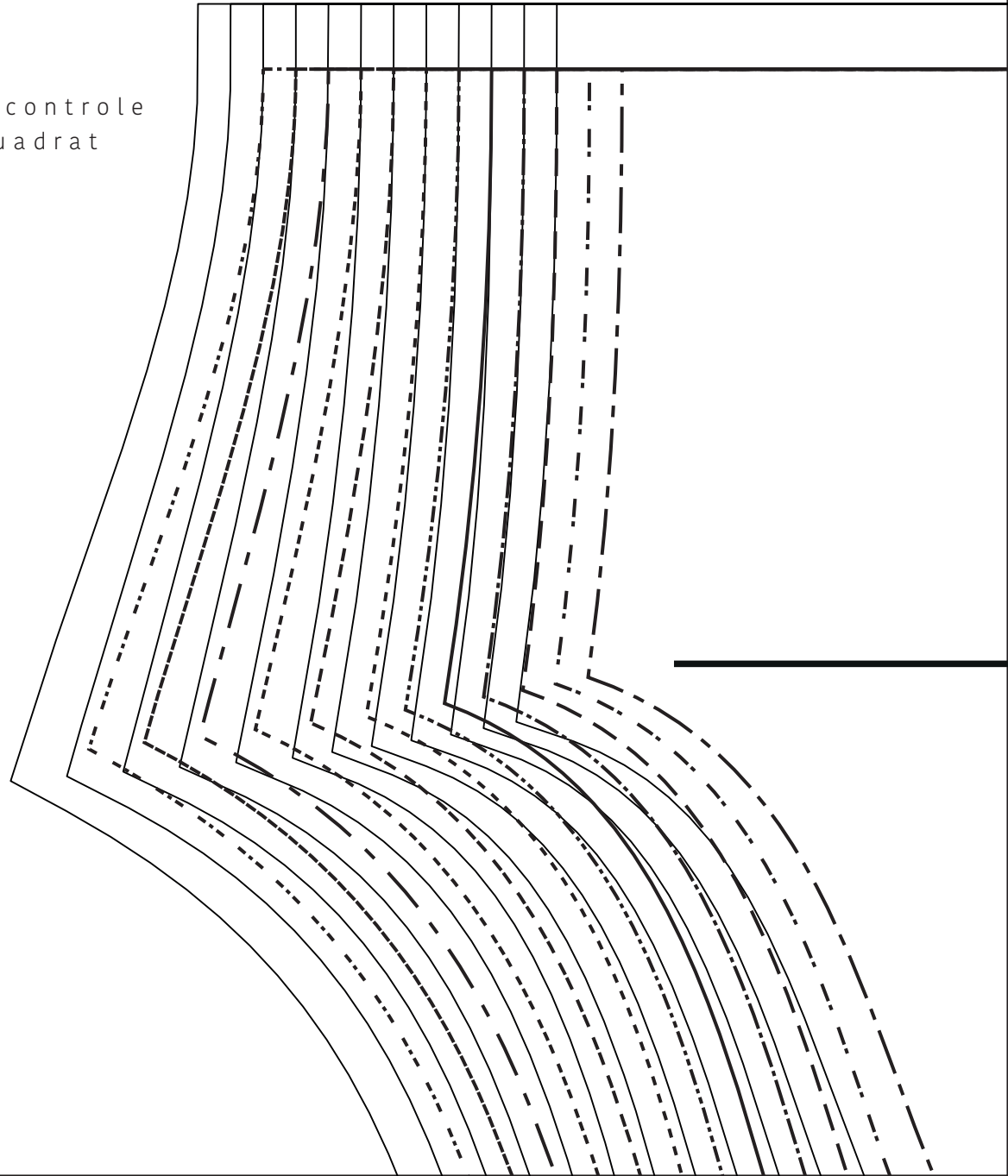
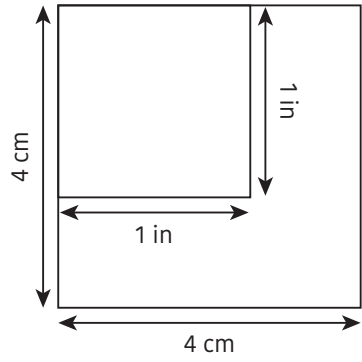



MR/MDS/CB/RM

**B**



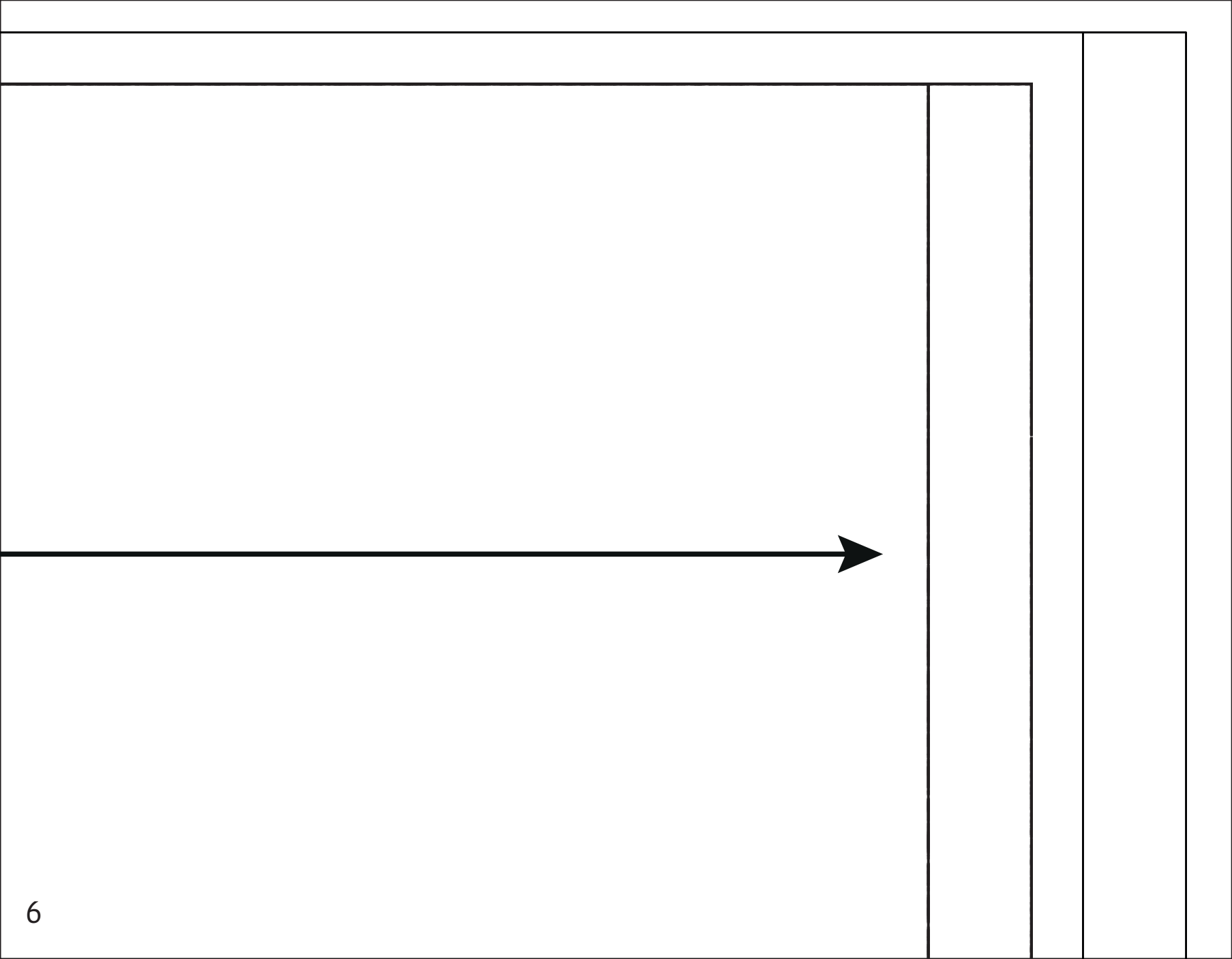

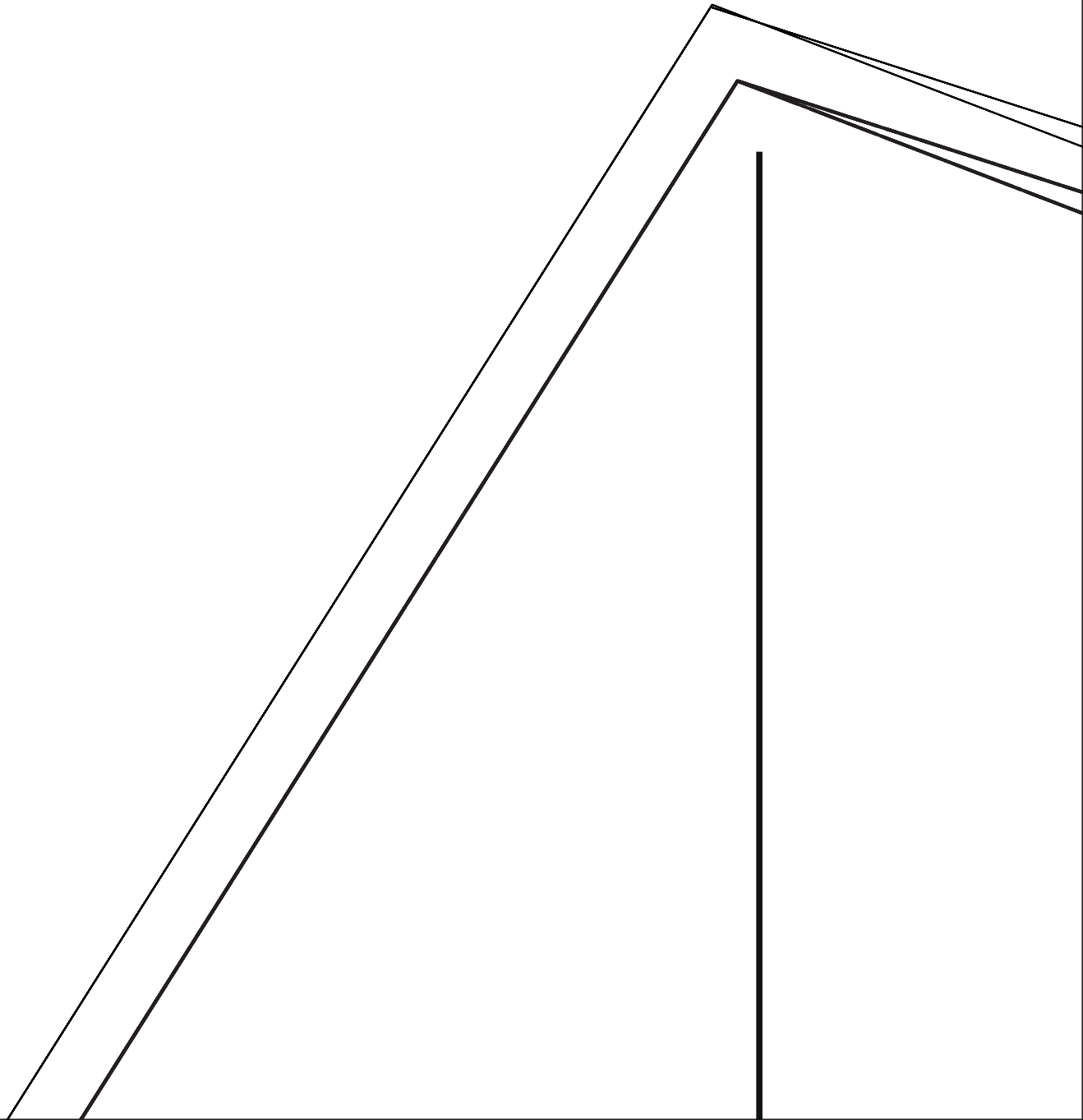

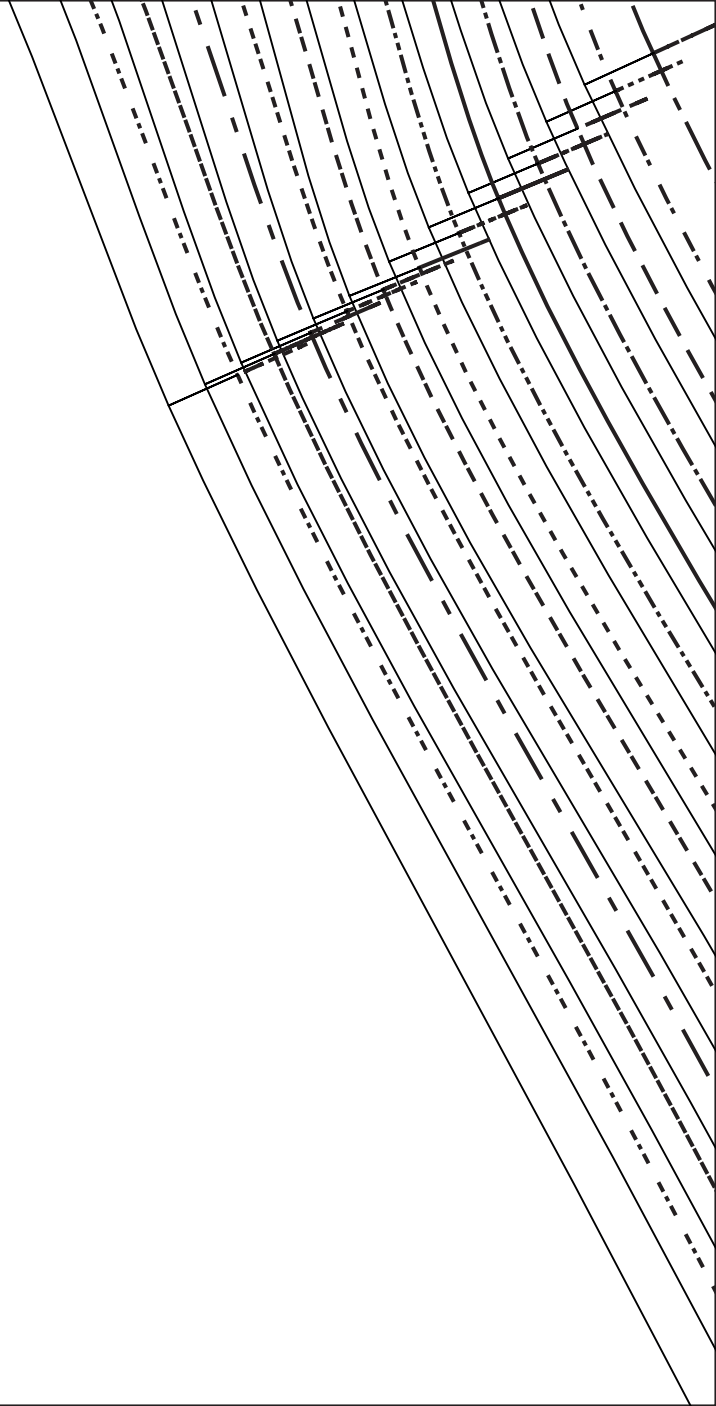
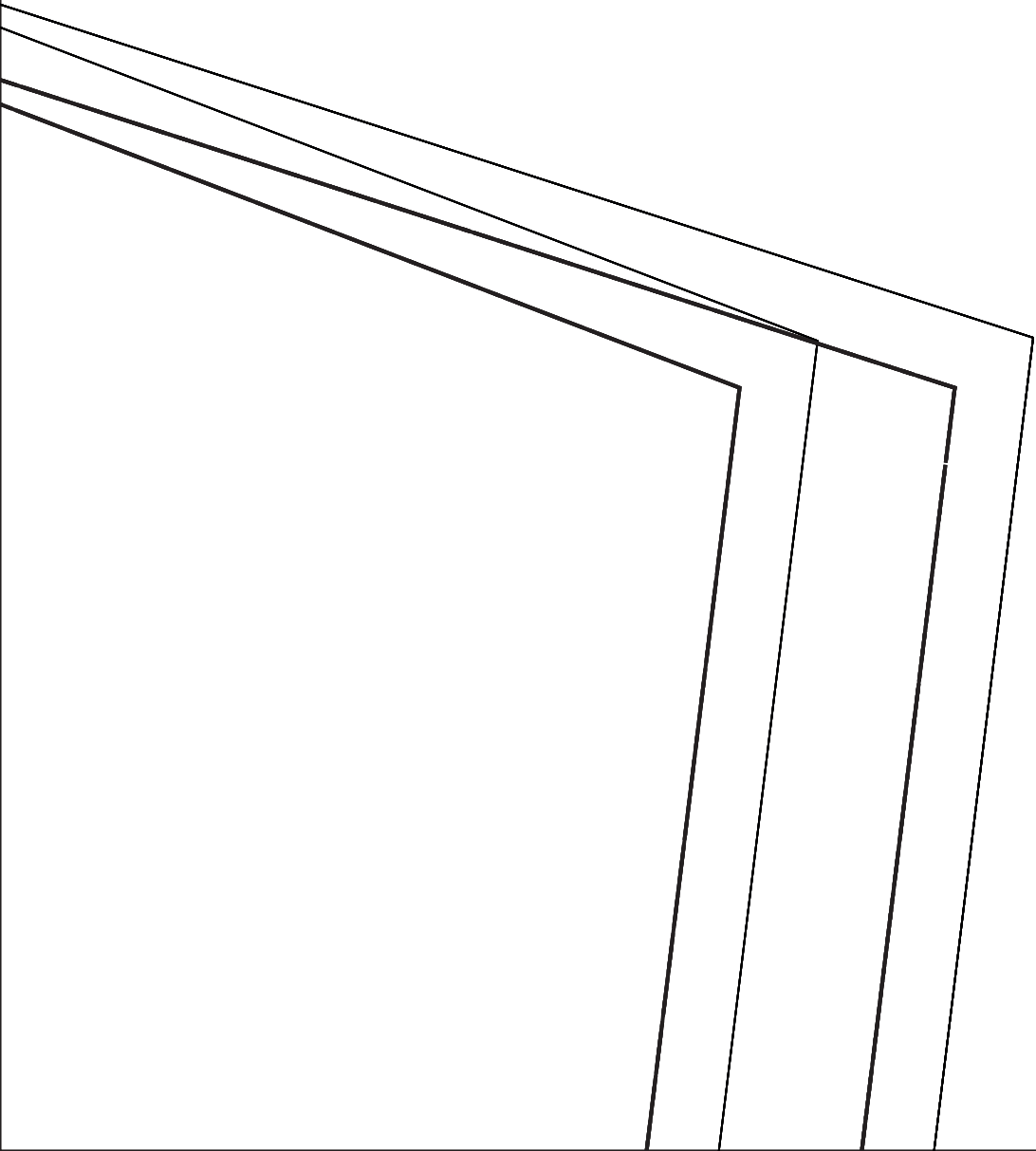



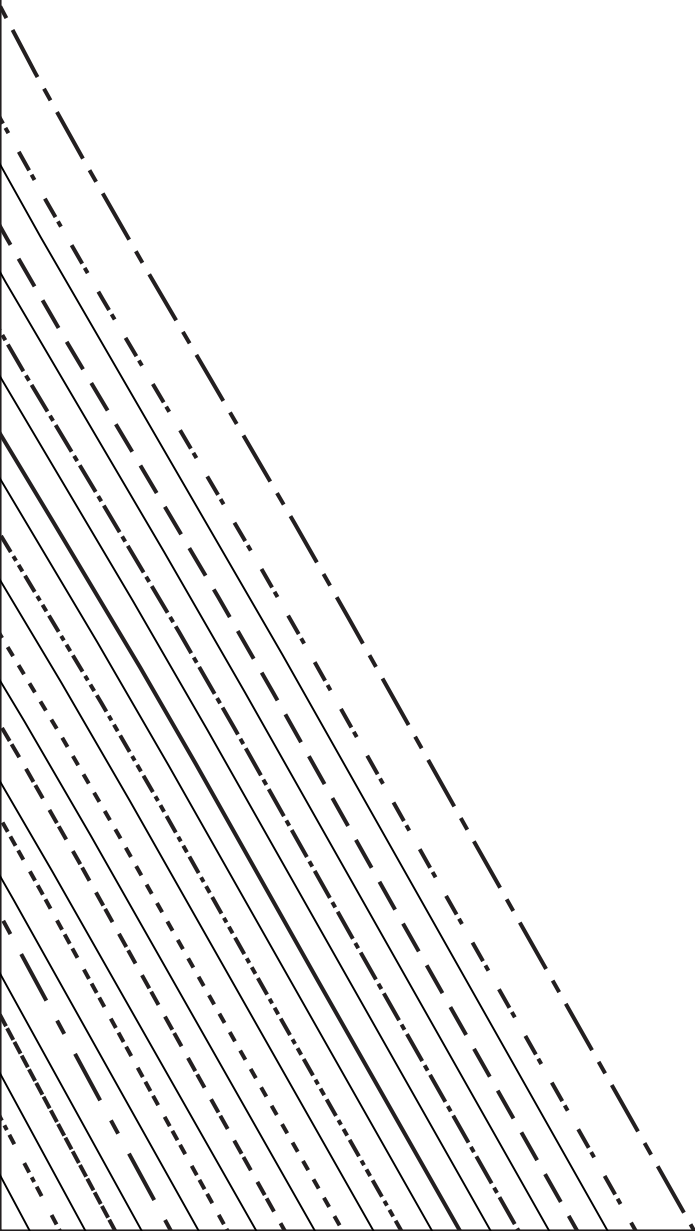

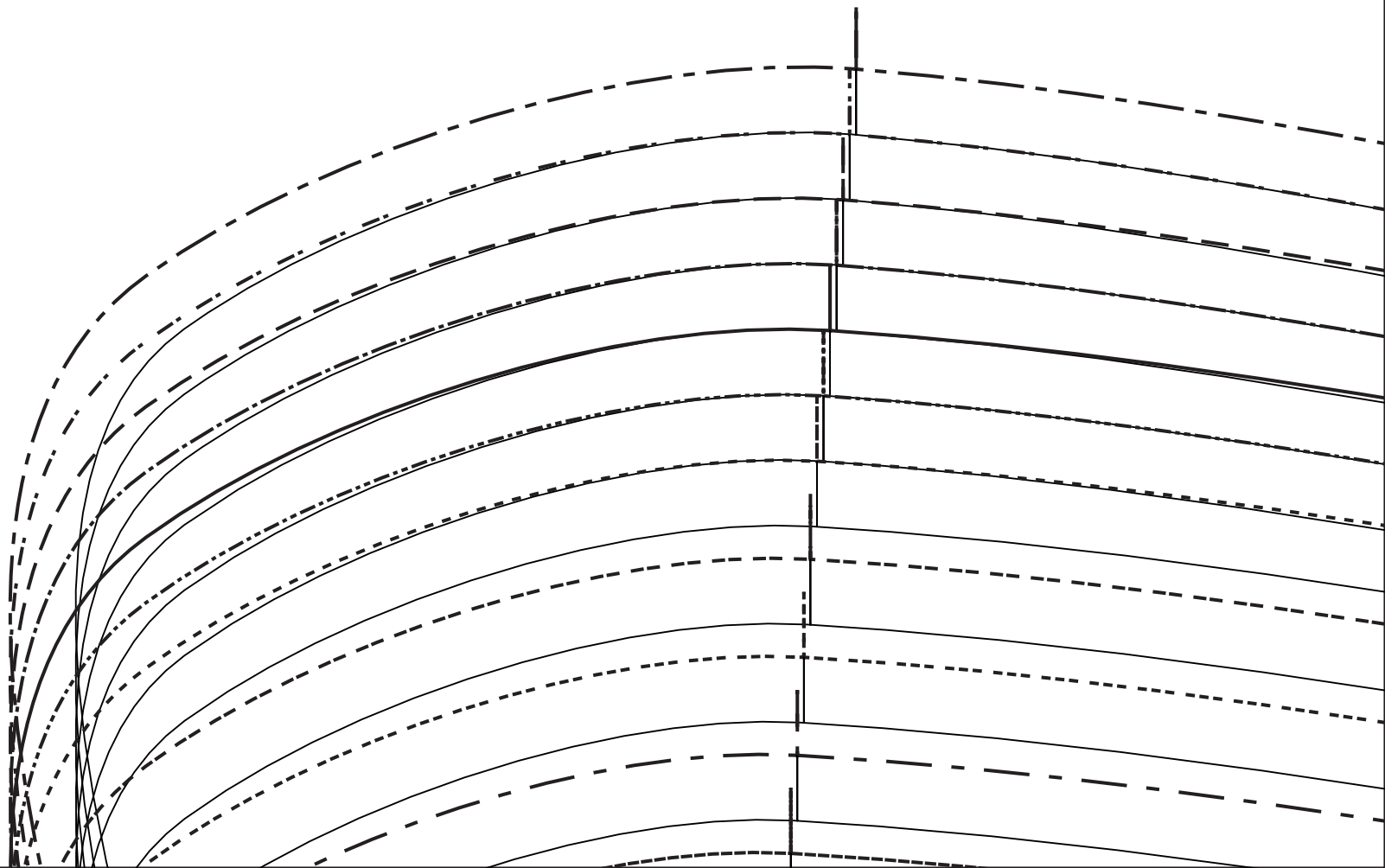



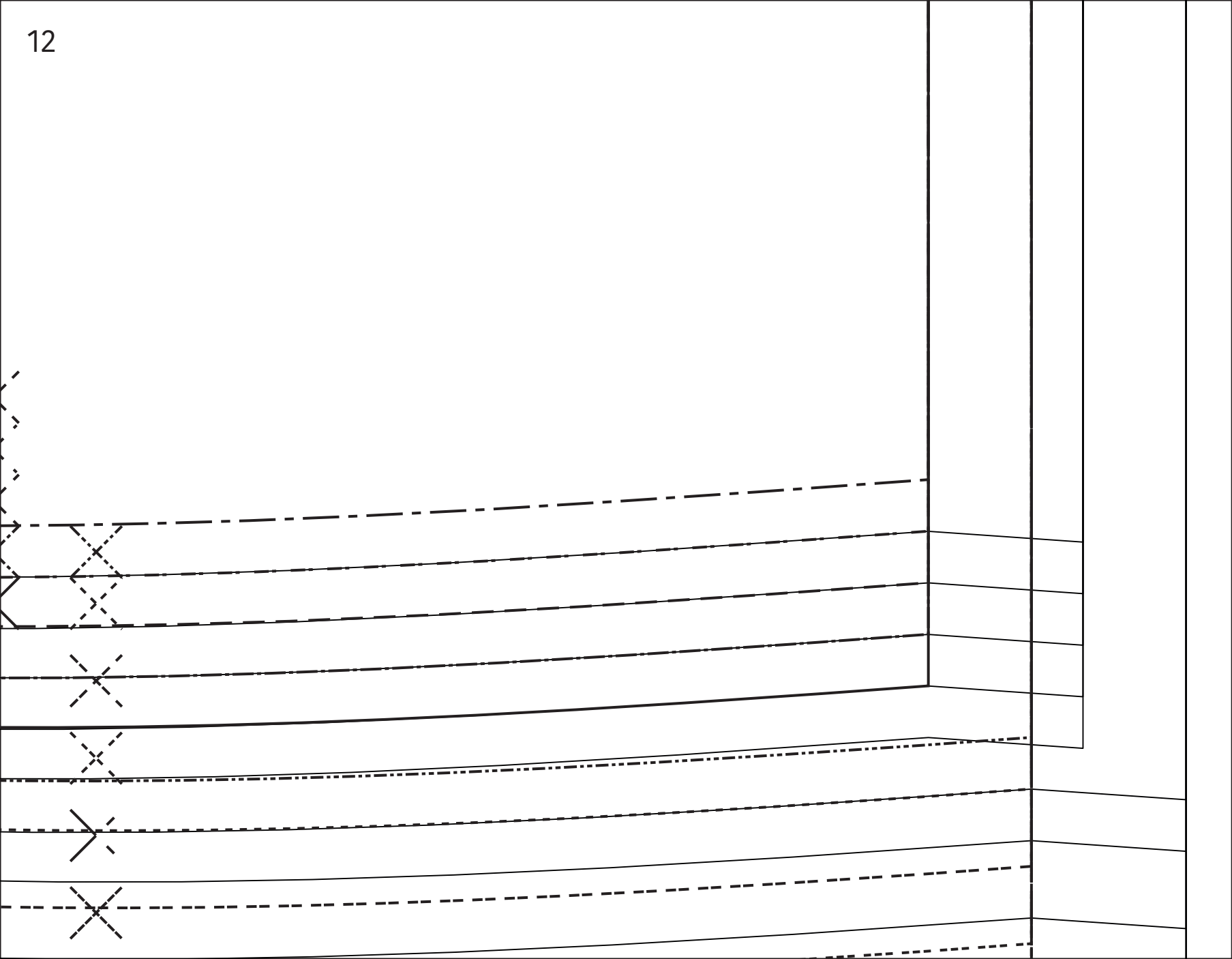

13

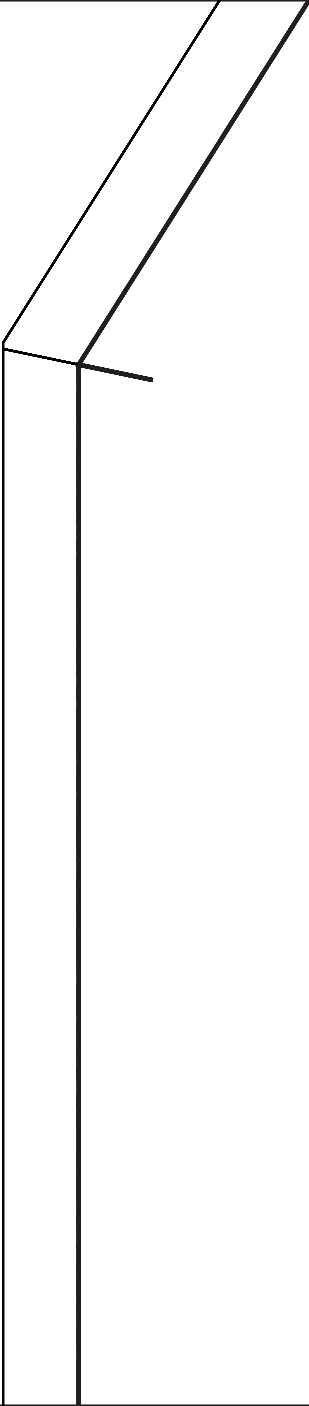

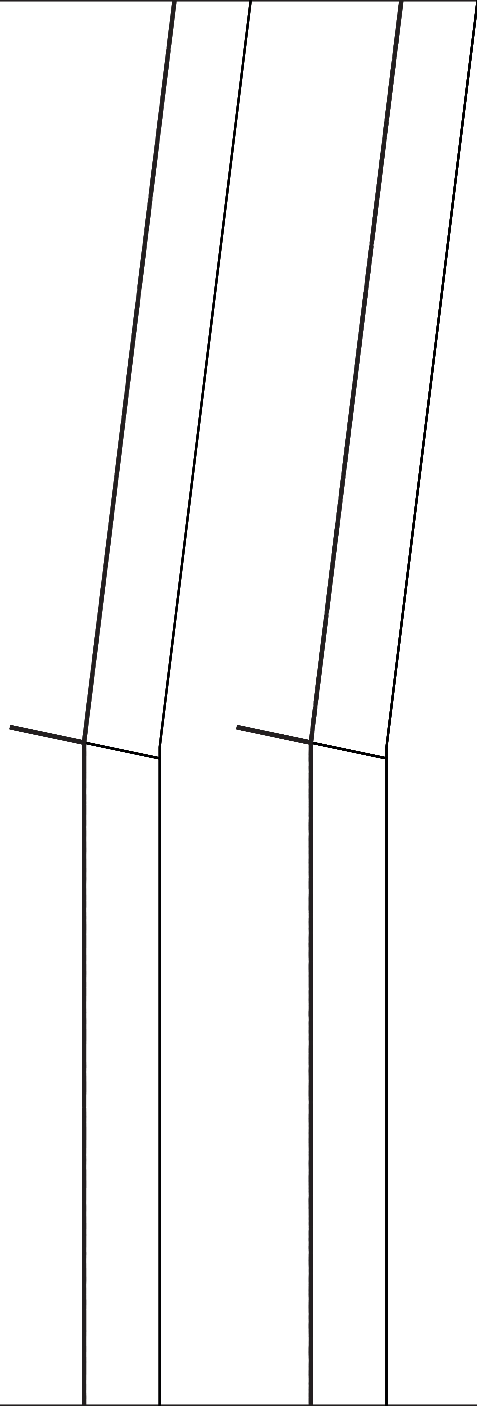

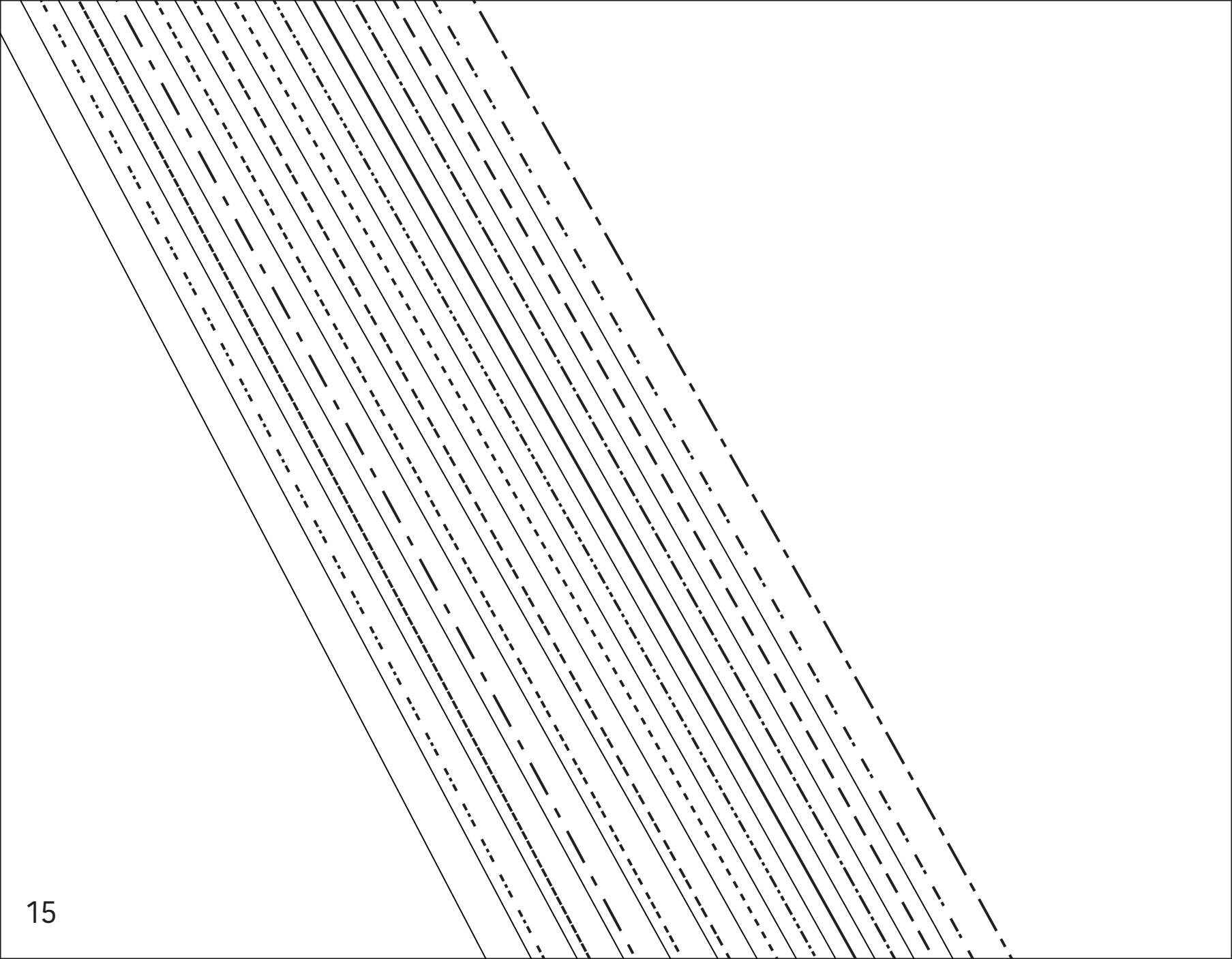

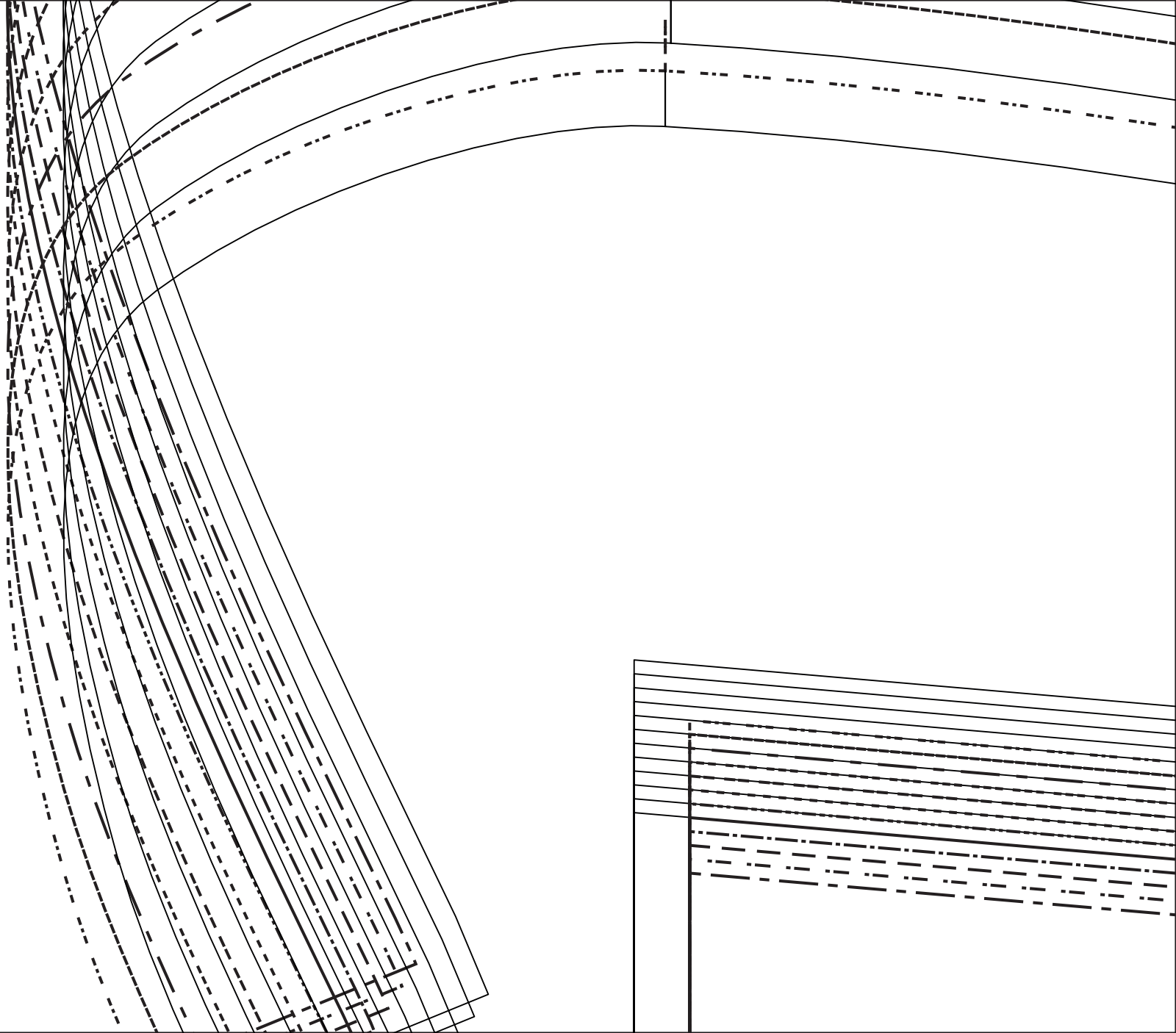



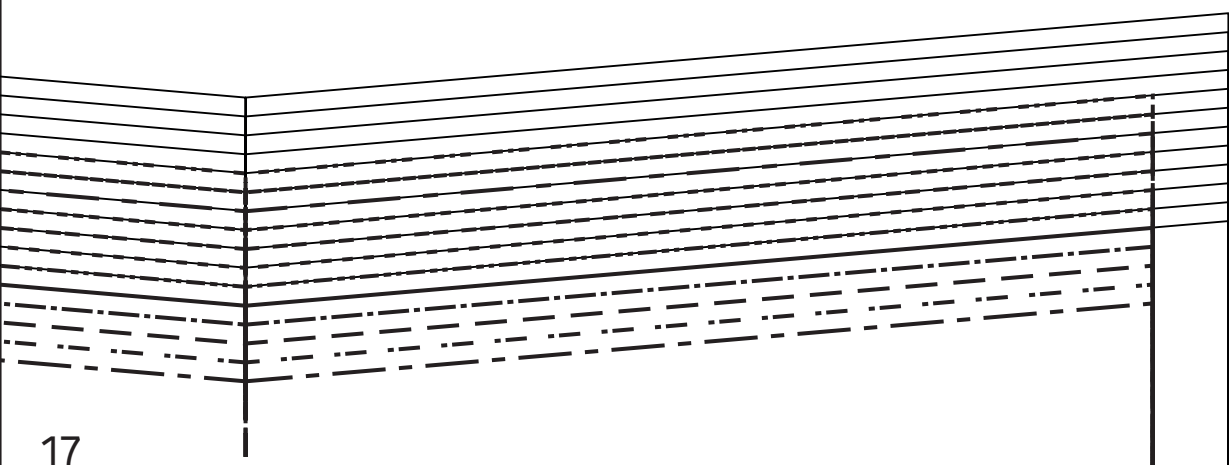
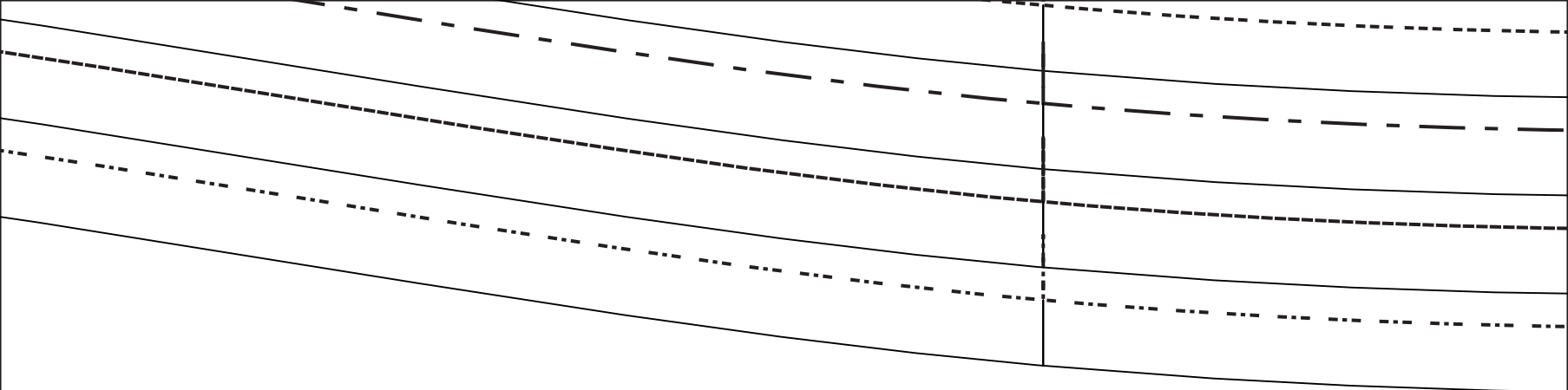

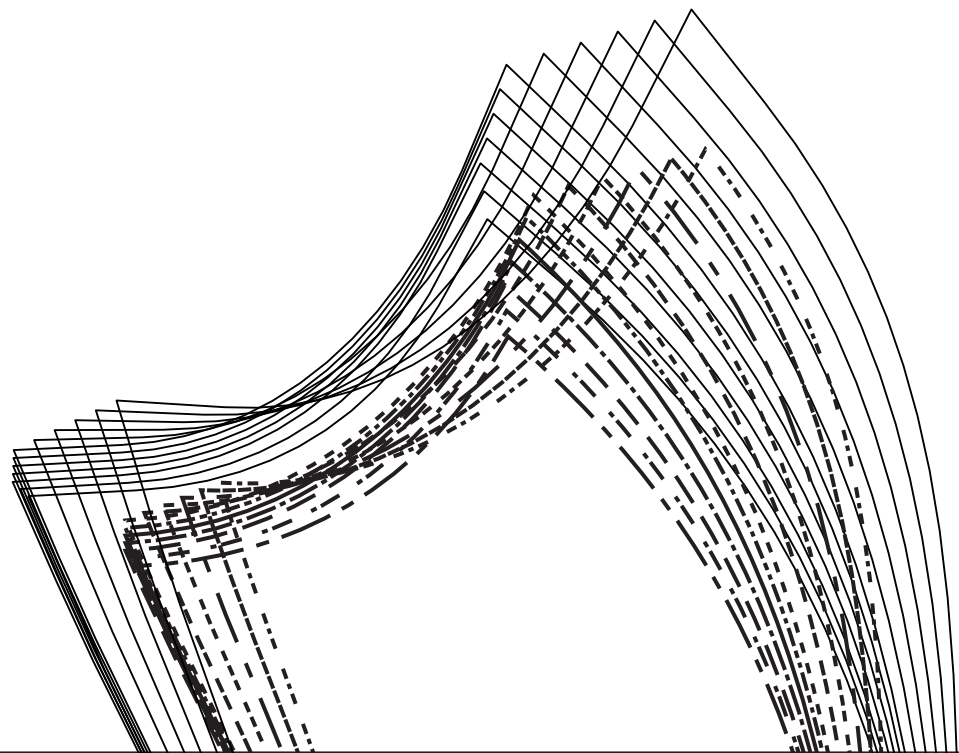
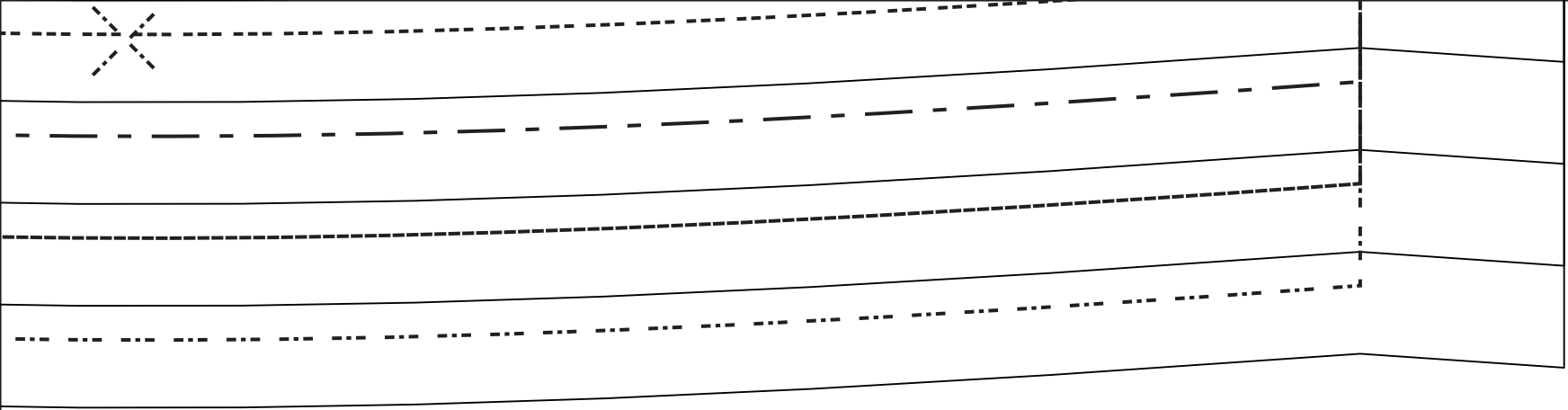



--	--	--	--	--

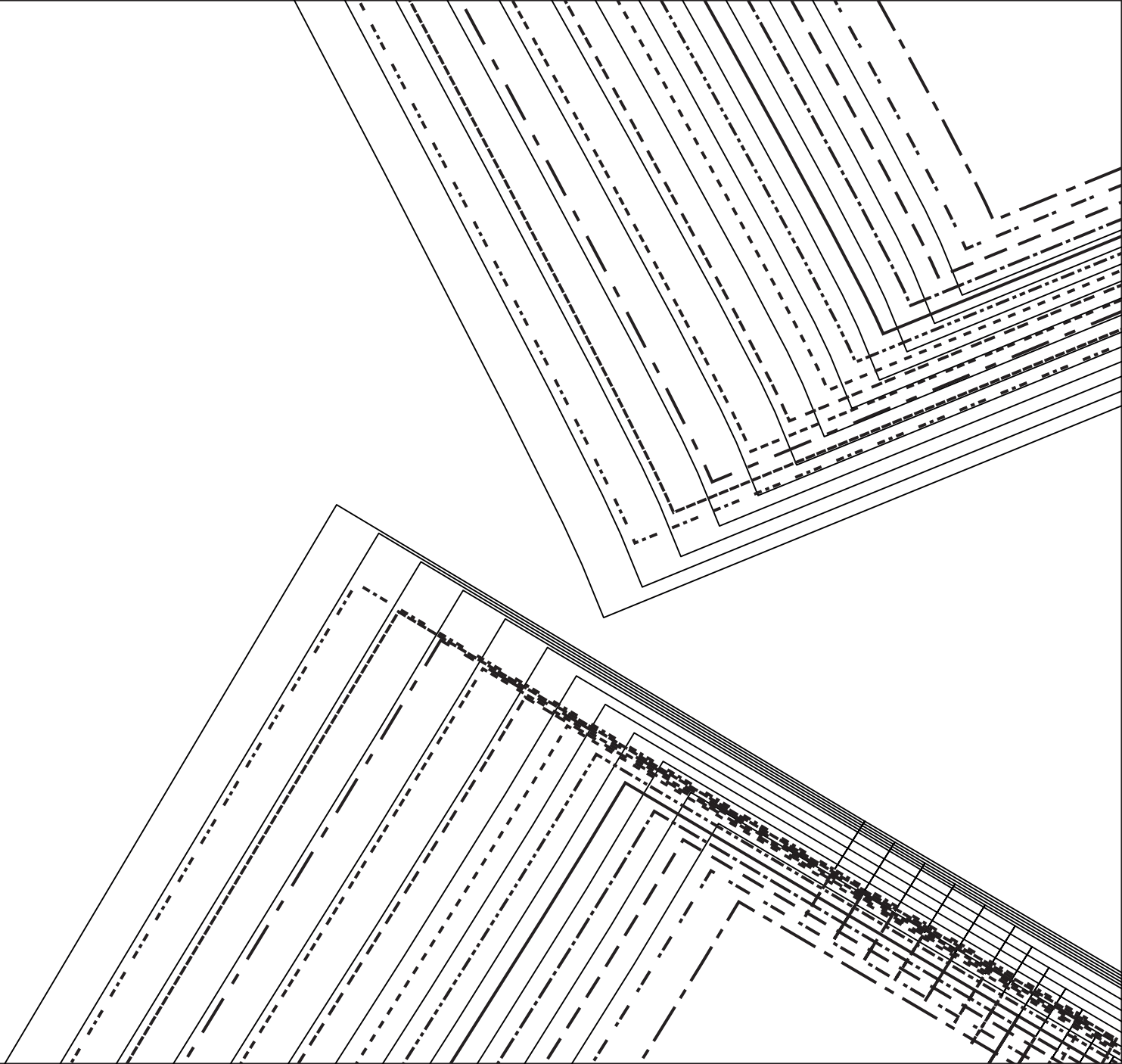

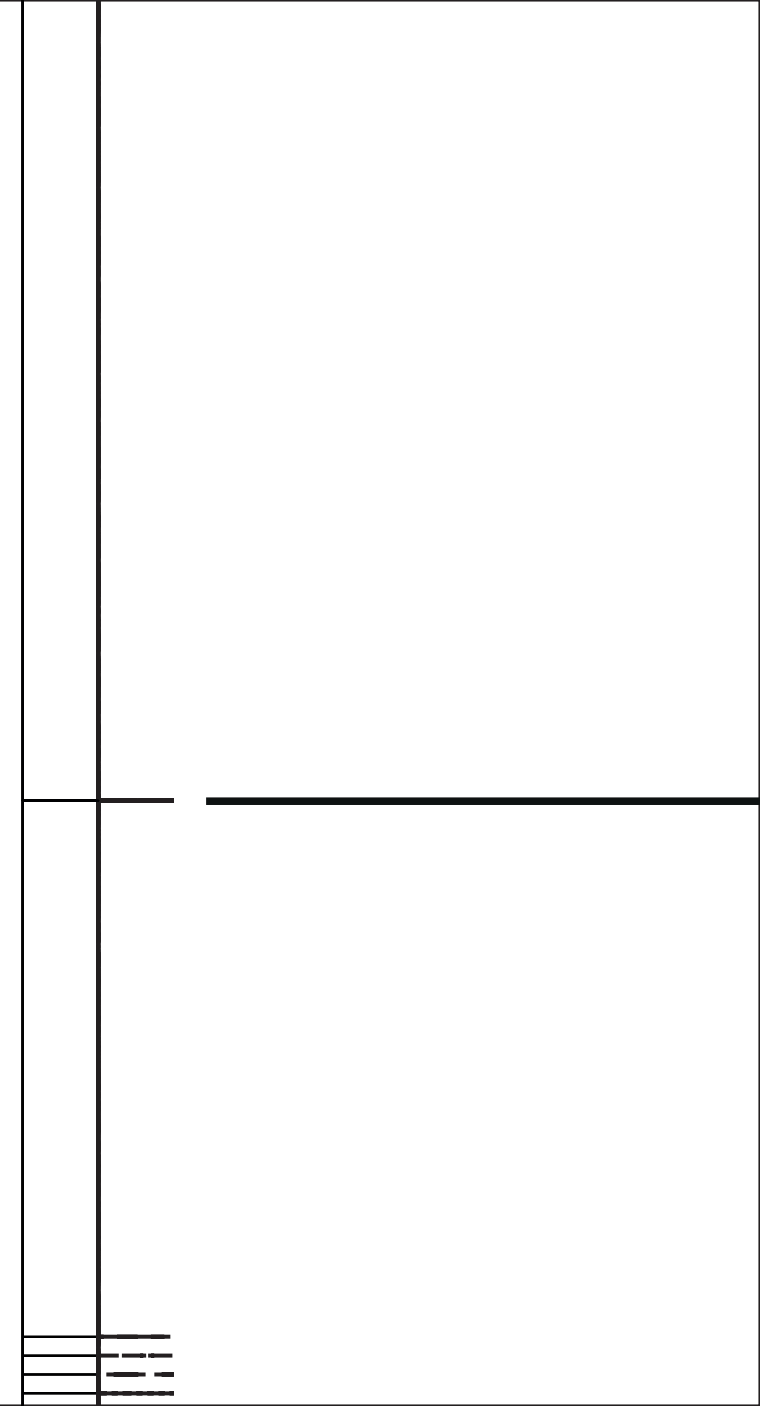
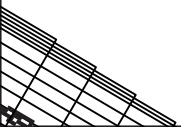
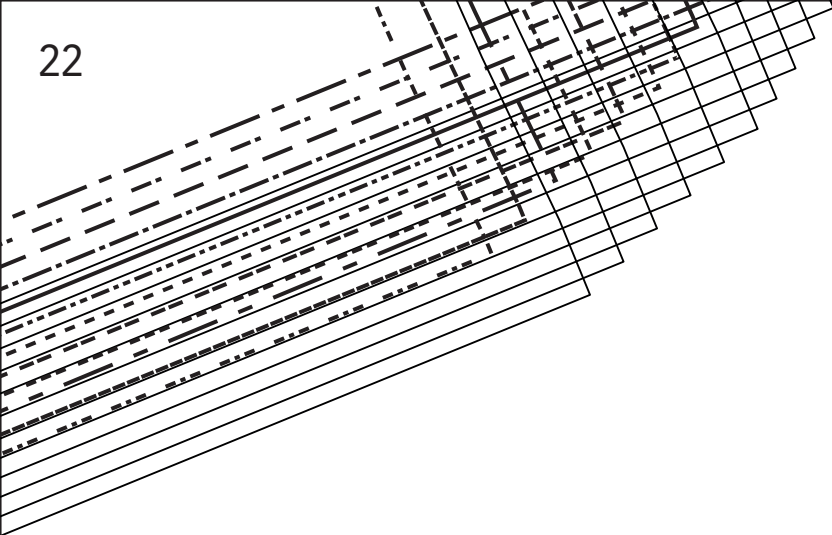

**C**



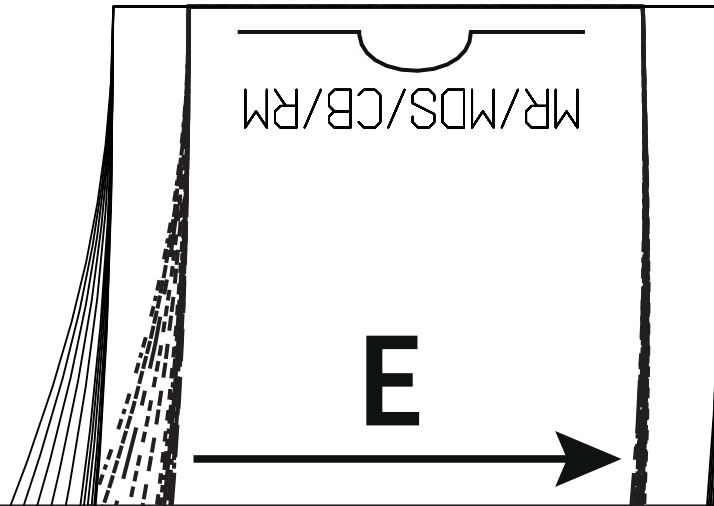
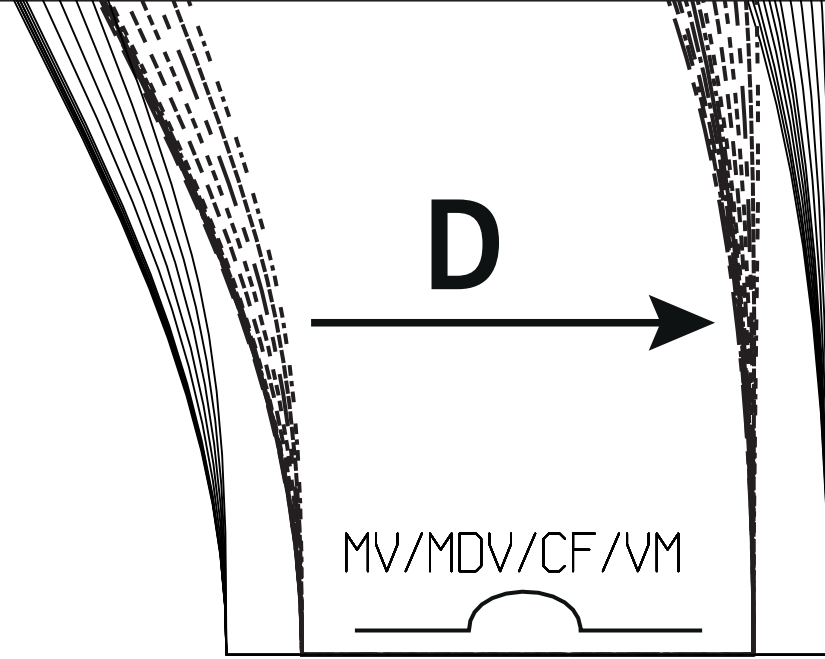





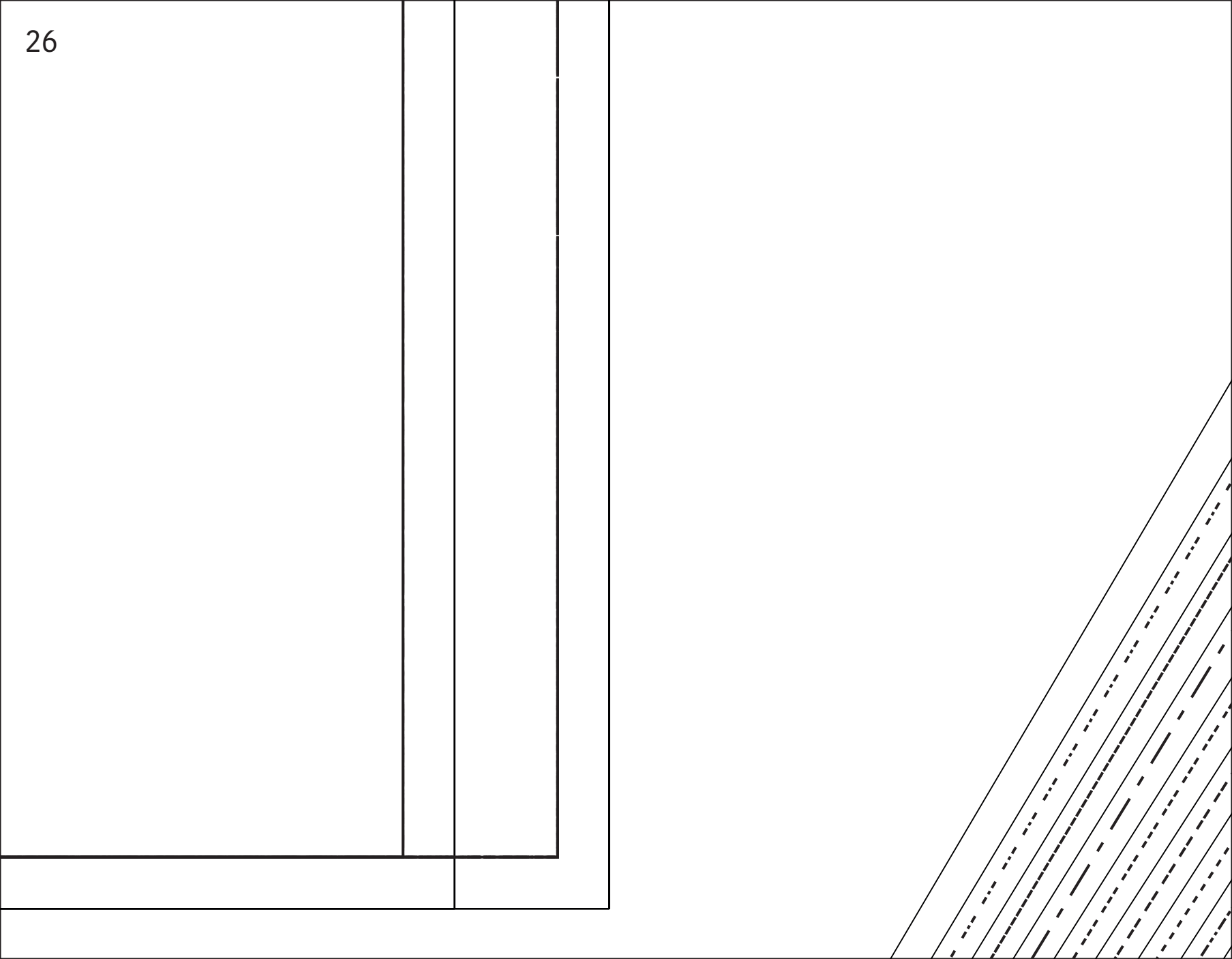

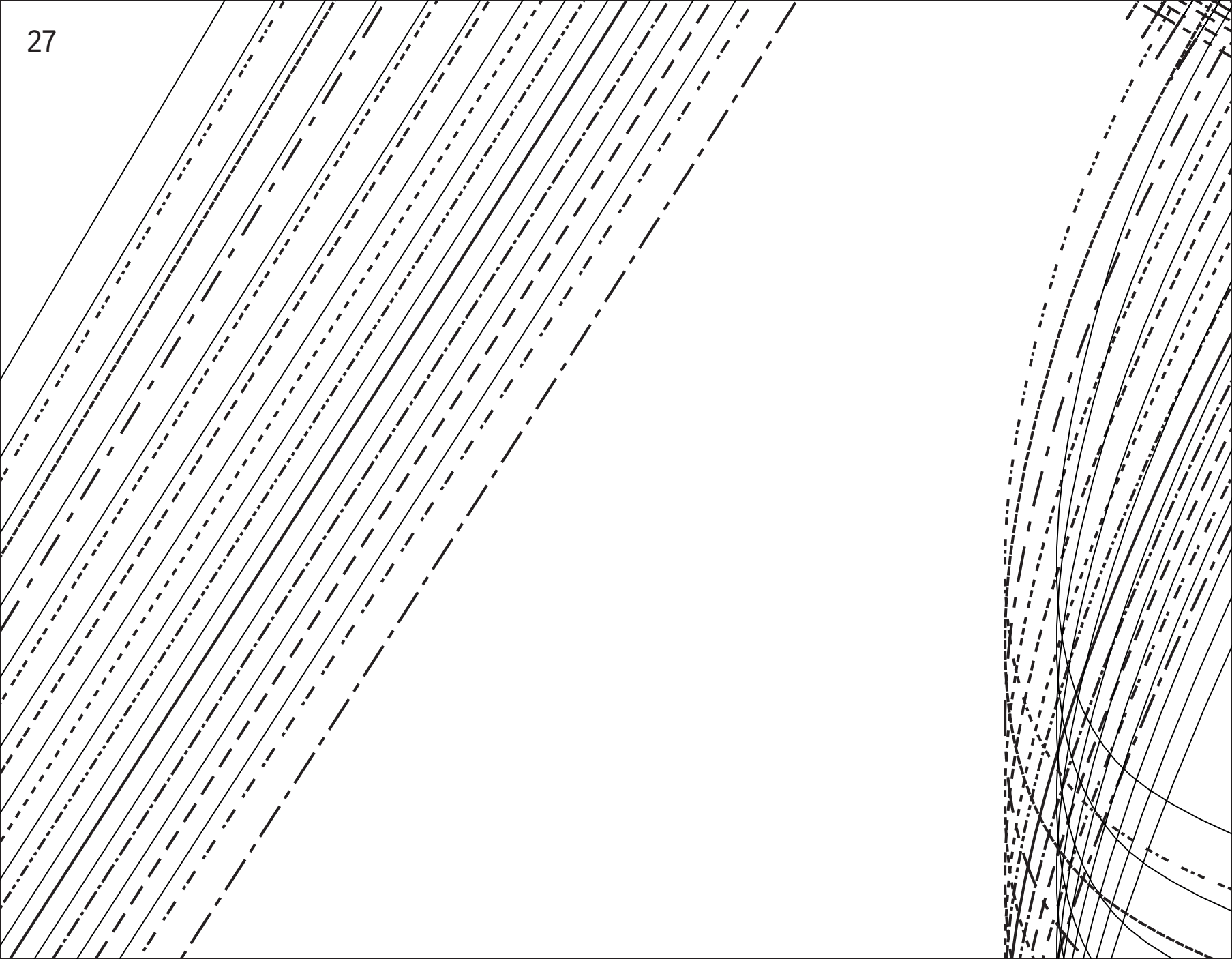

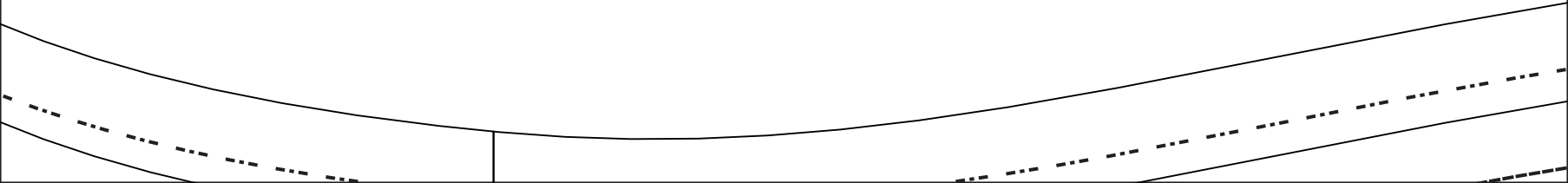
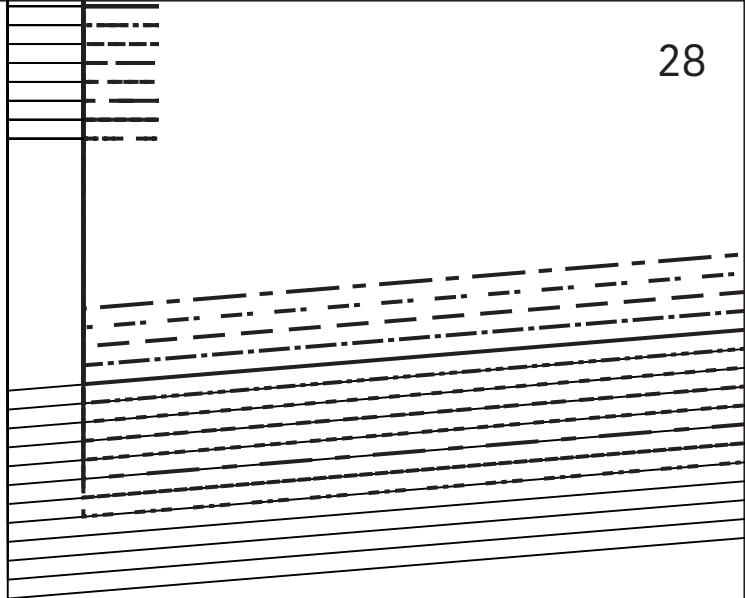
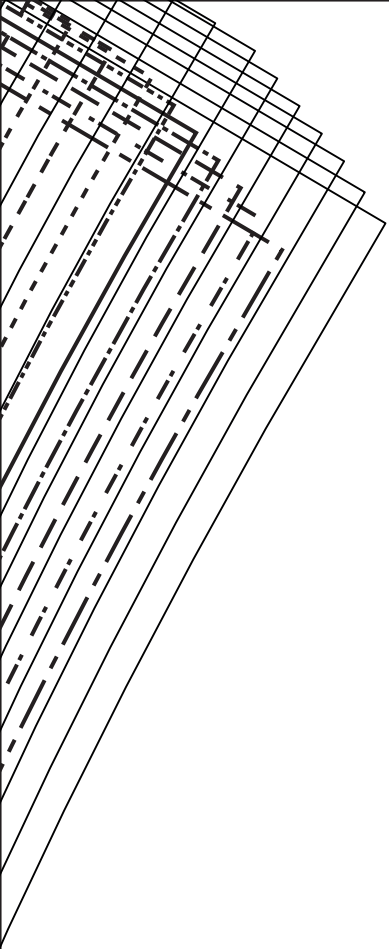

—
- - -
· · ·
- · -
- - -
- · -
- - -
- · -
- - -
- · -

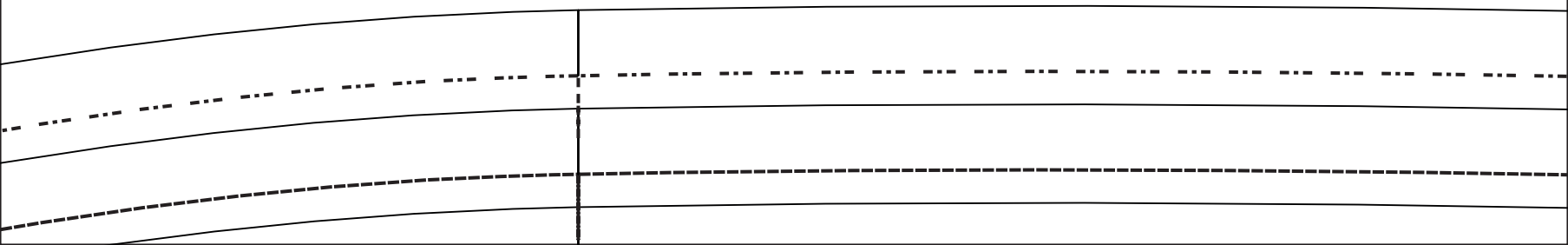
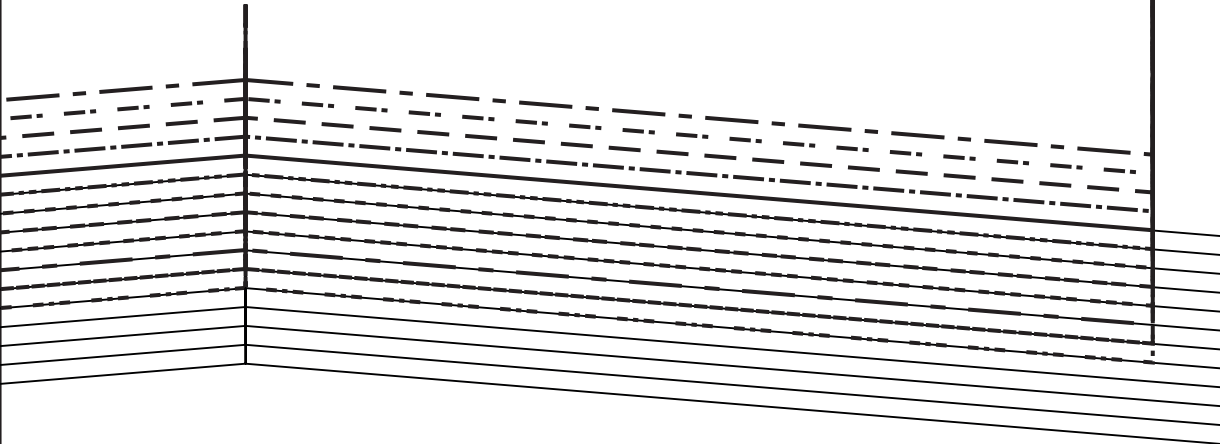

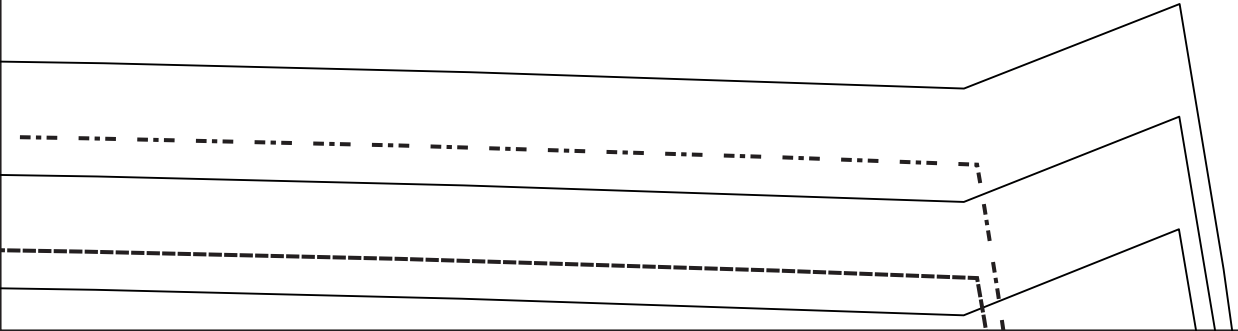
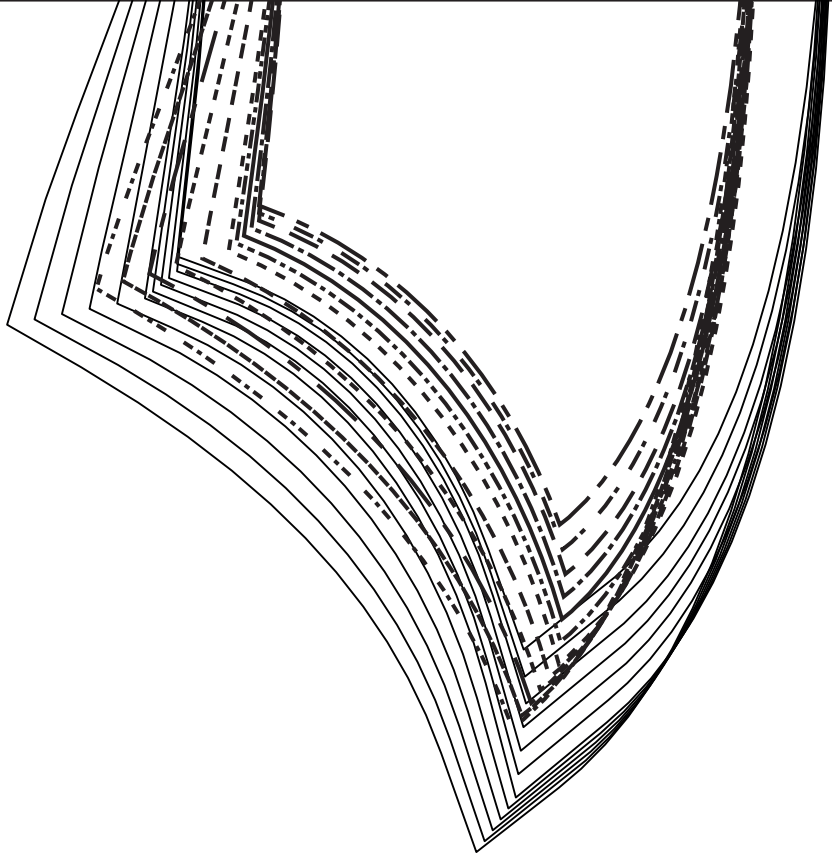



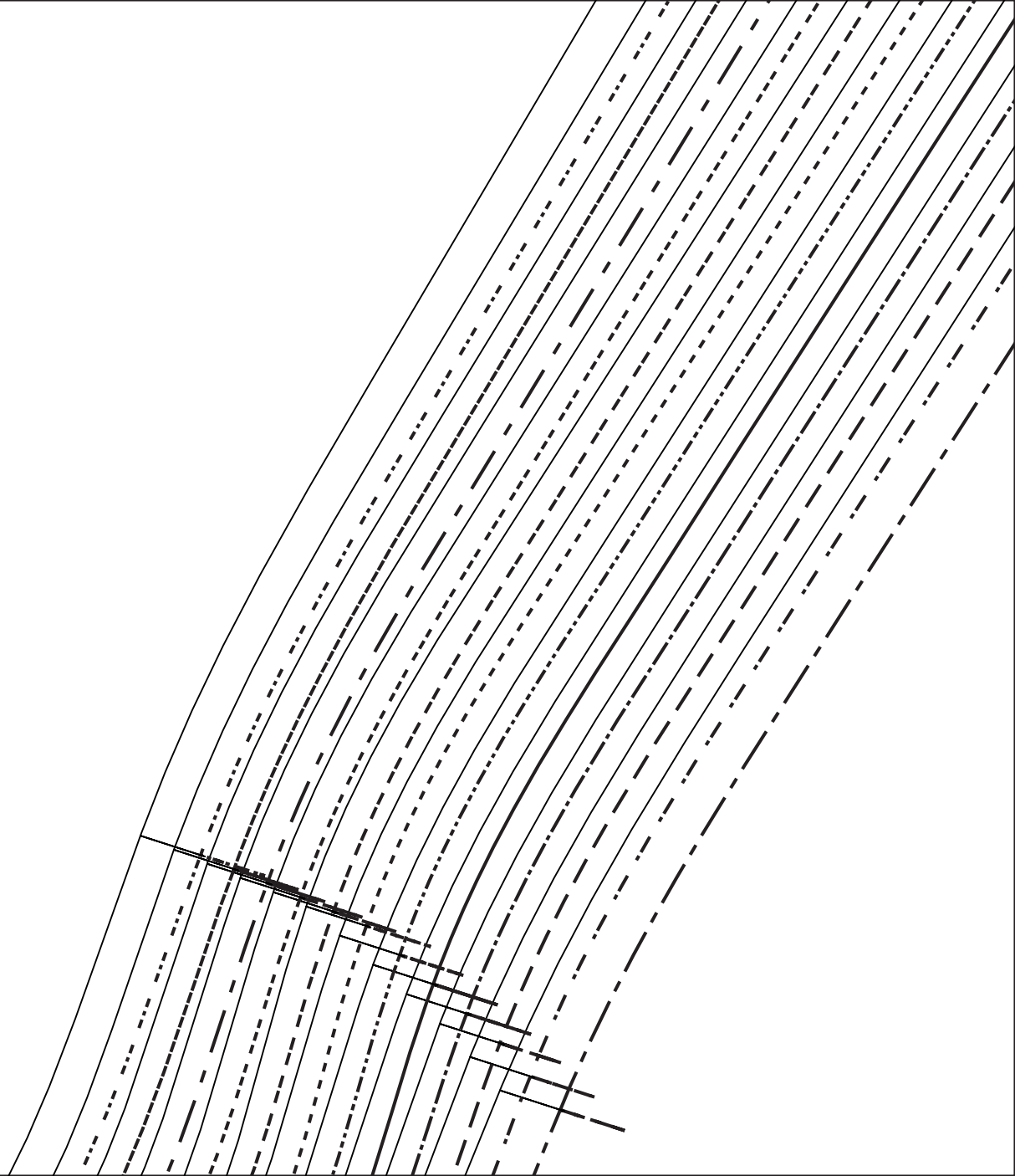



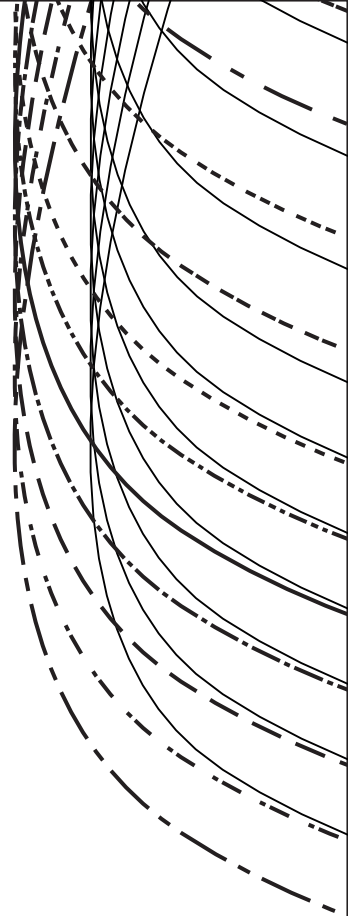
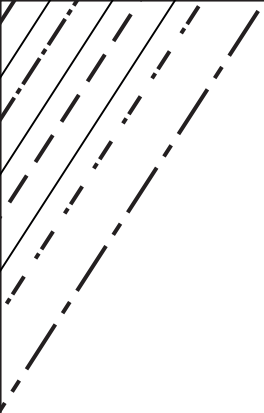

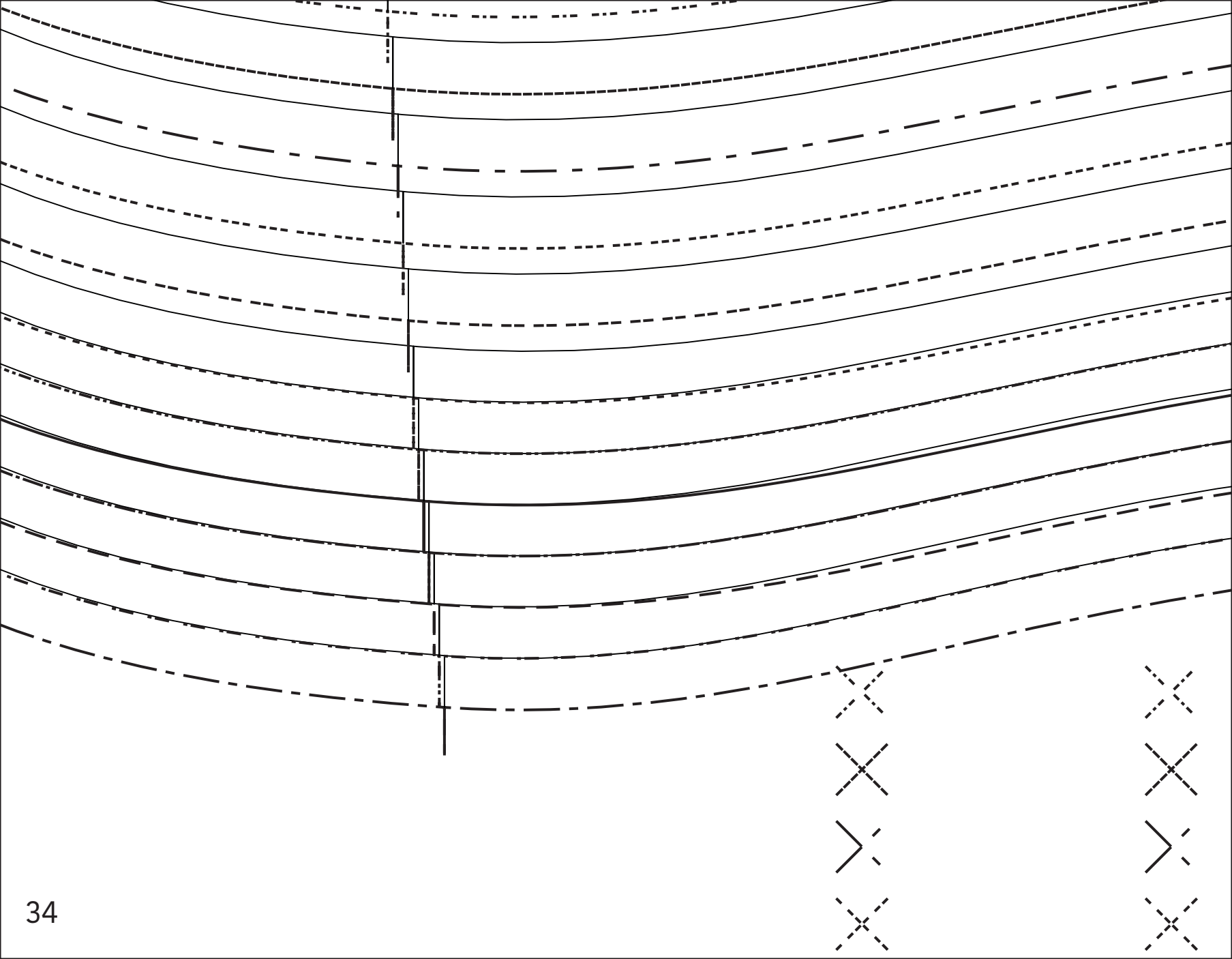

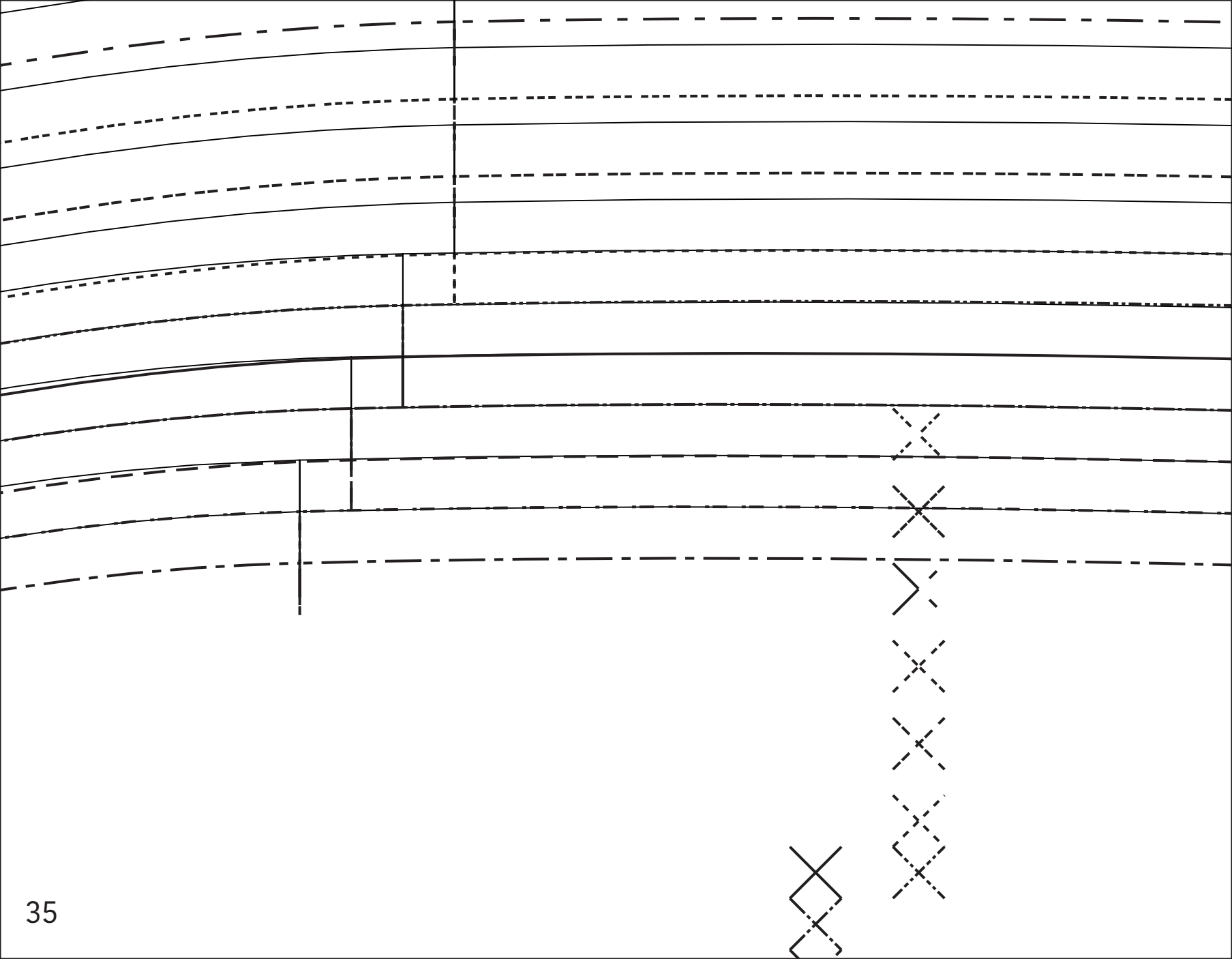

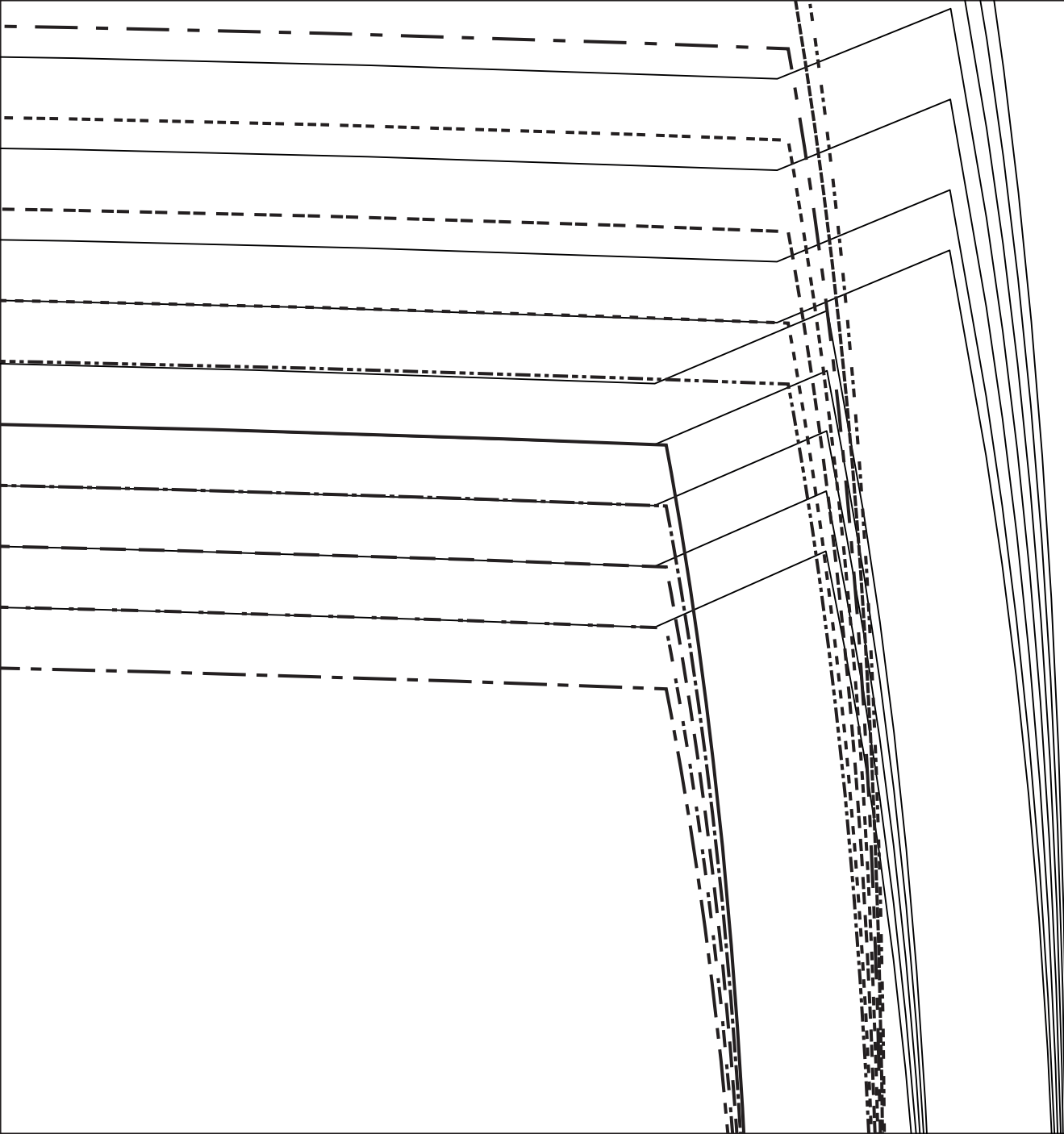



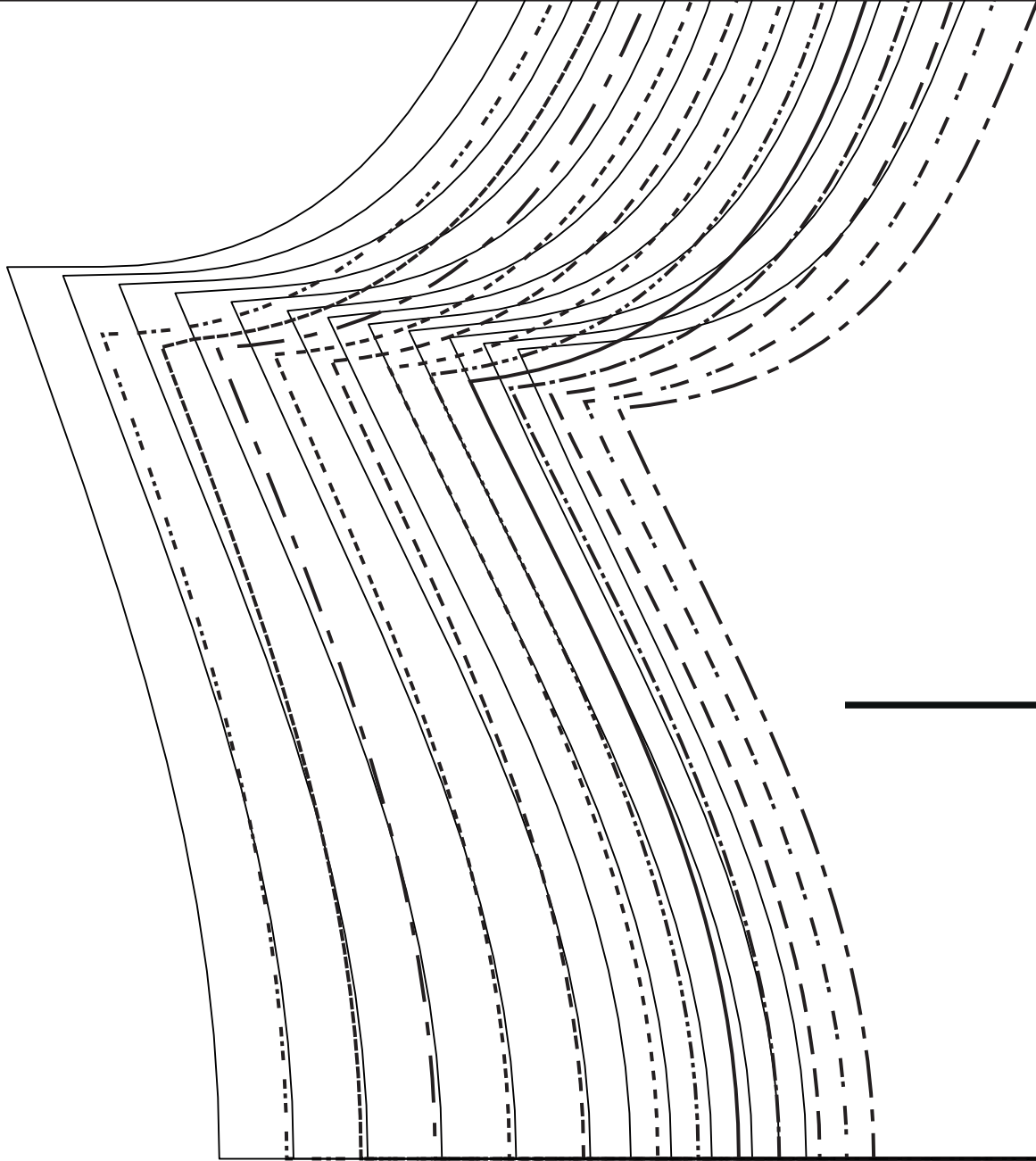



**A**



MV/MDV/CF/VM





