

Patroonschema / Schéma du Patron / Pattern Diagram /  
Übersichtsplan zum Zusammenkleben

**Chase**  
**T-shirt**

**Maten / Tailles / Sizes:**

..... XXS  
----- XS  
----- S  
----- M  
----- L  
----- XL  
----- XXL  
----- XXXL

**Patroondelen / Pièces du patron /  
Pattern pieces:**

**A** voorpand / devant / front panel  
**B** rugpand / dos / back panel  
**C** mouw / manche / sleeve  
**D** halsboord / bord encolure / collar  
**E** bies hals RP / liseré encolure DS /  
collar trim BP

1	2	3	4	5	6
7	8	9	10	11	12
13	14	15	16	17	18
19	20	21	22	23	24

Controlevierkant / Carré de controle  
/ Test square / Kontrollquadrat

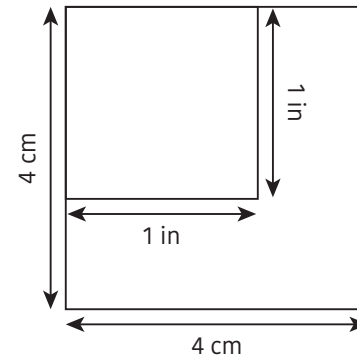

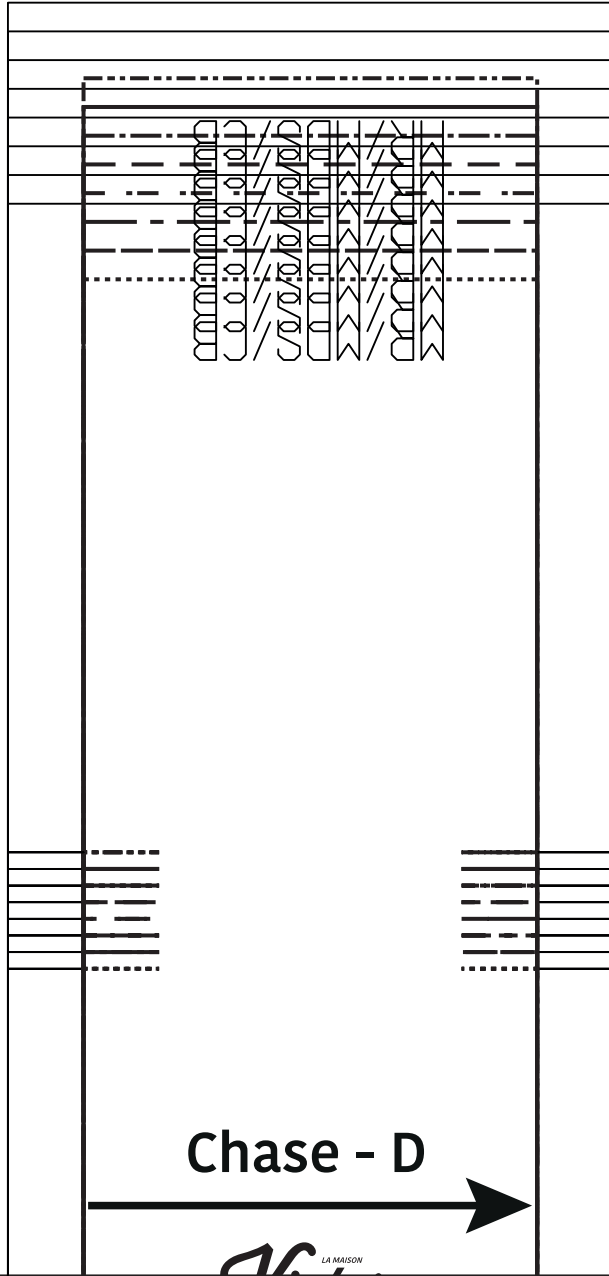

Chase - D

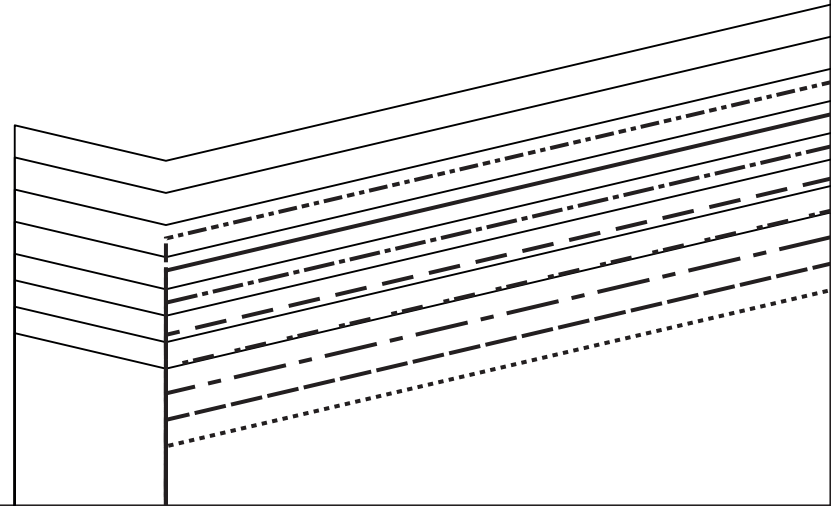

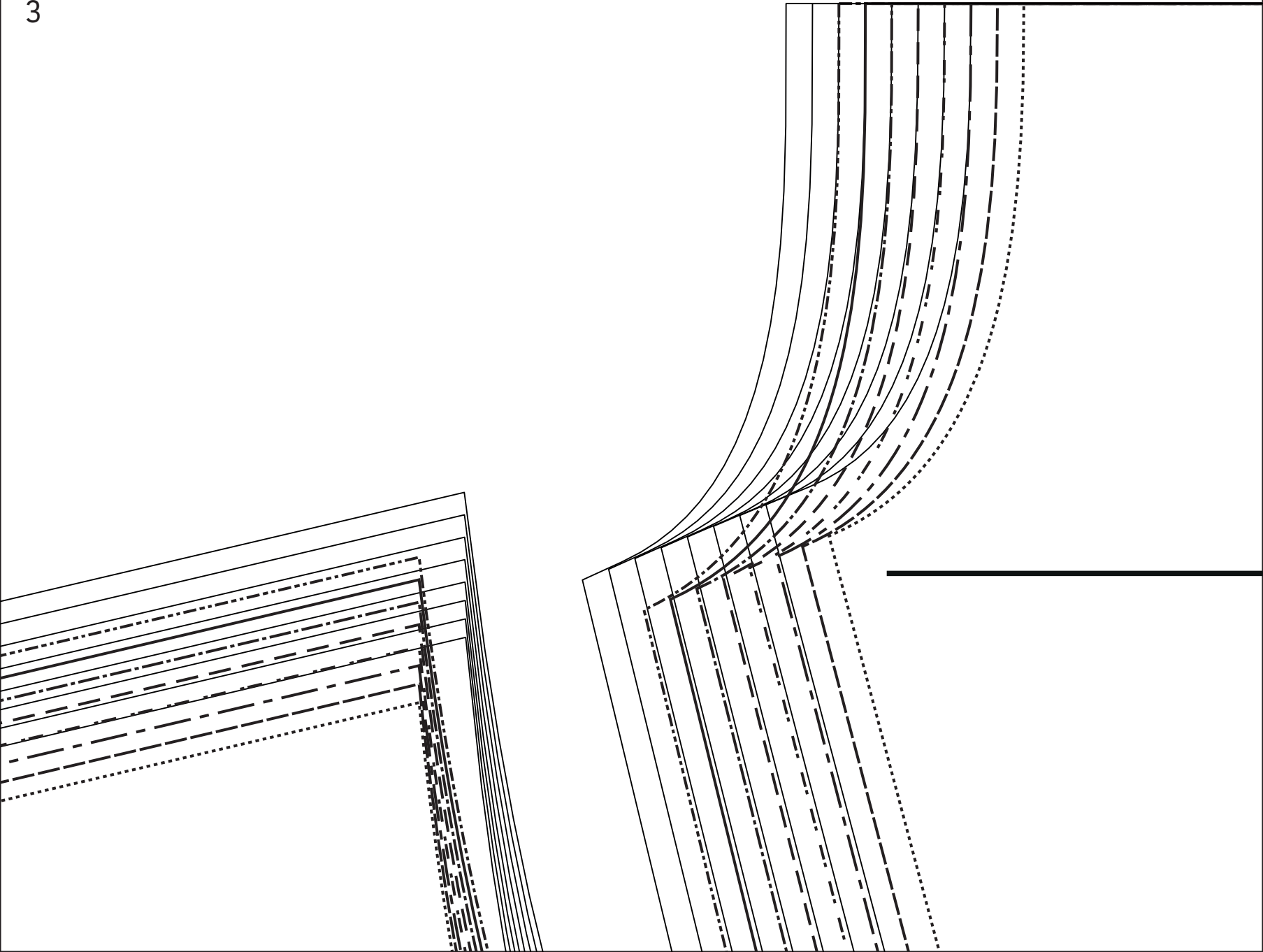



MR/MDS/CB

# Chase - B

*Victor*  
LA MAISON





*Victor*

MV/MDV/CF





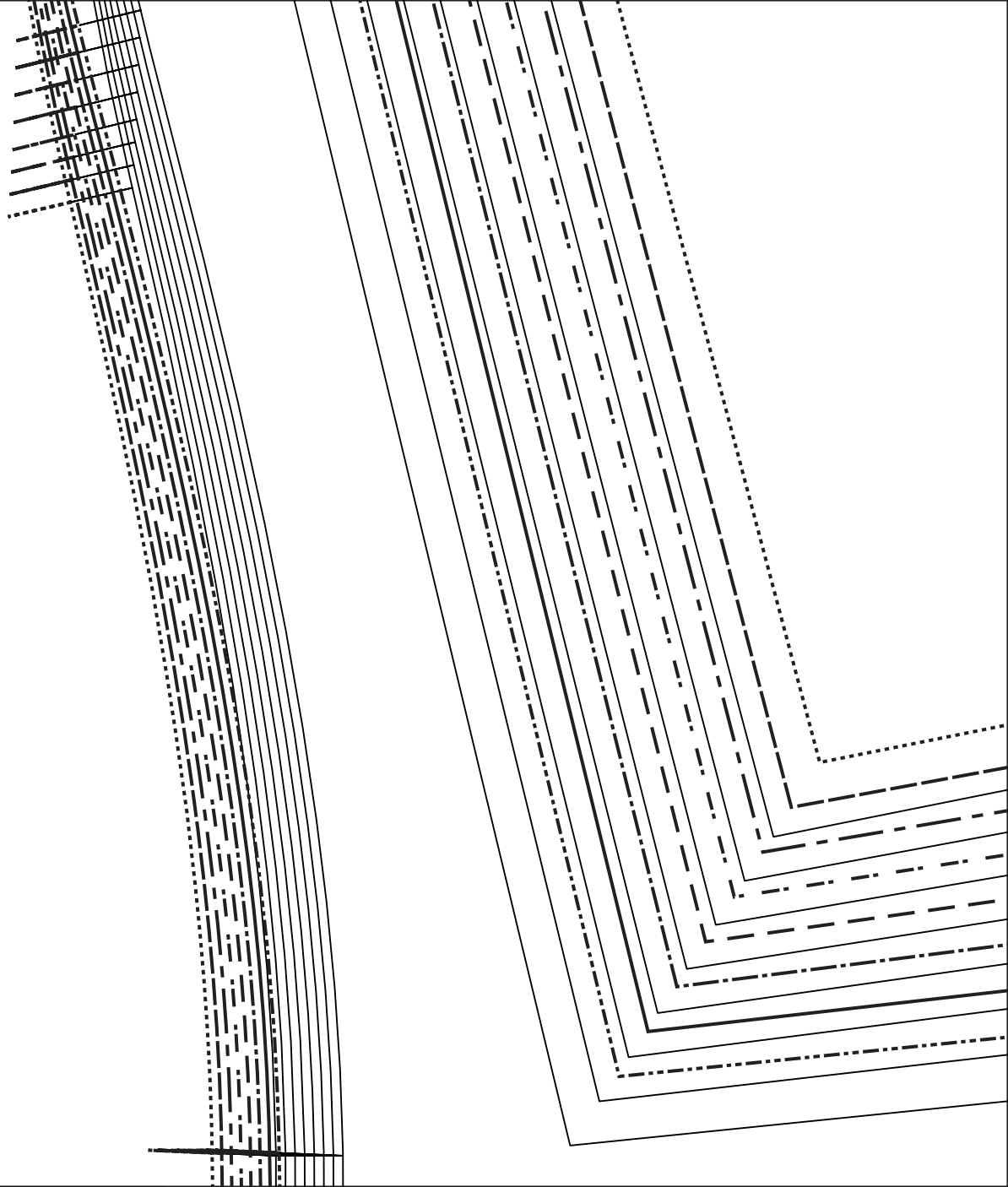

*W!*

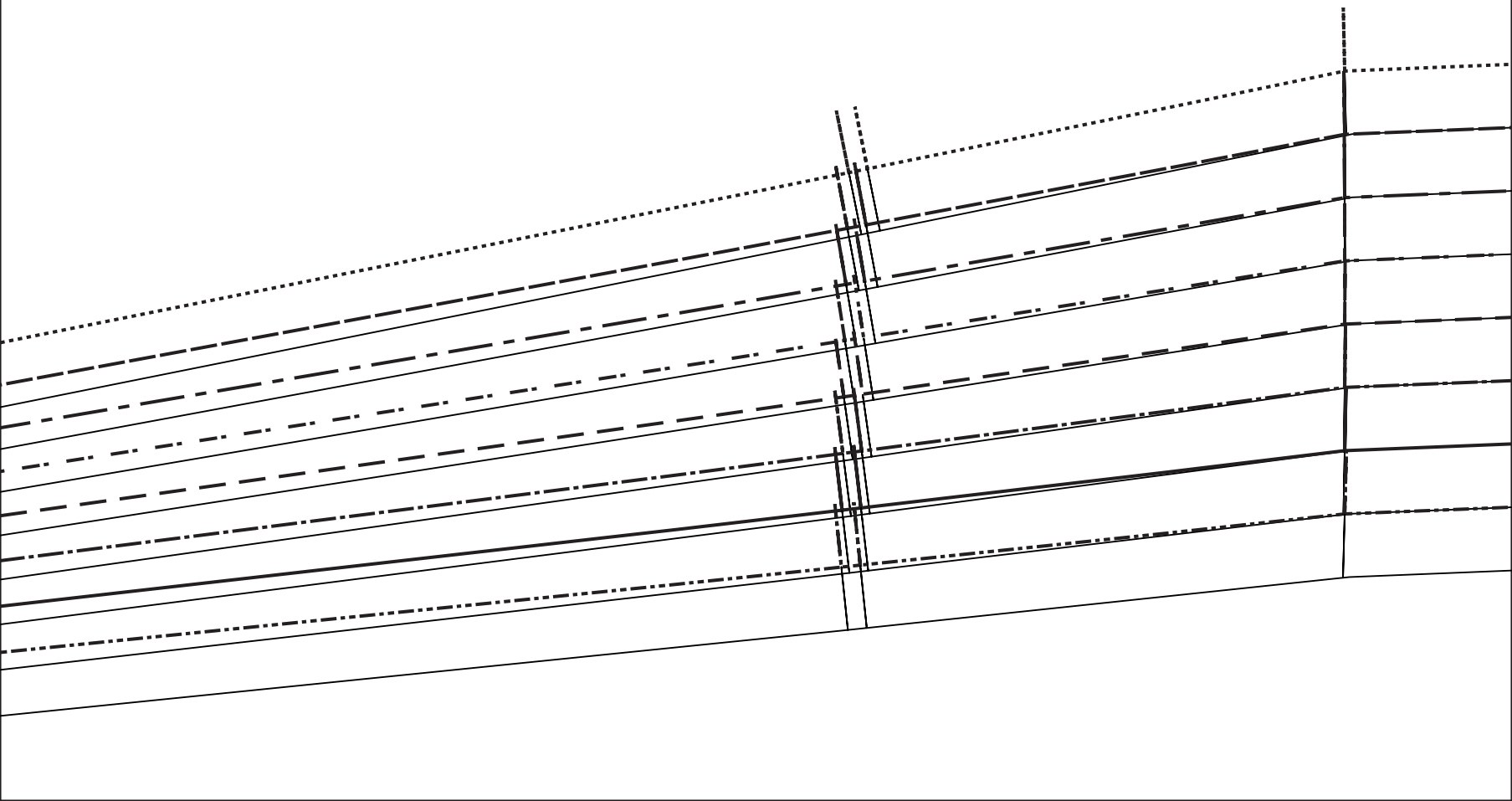

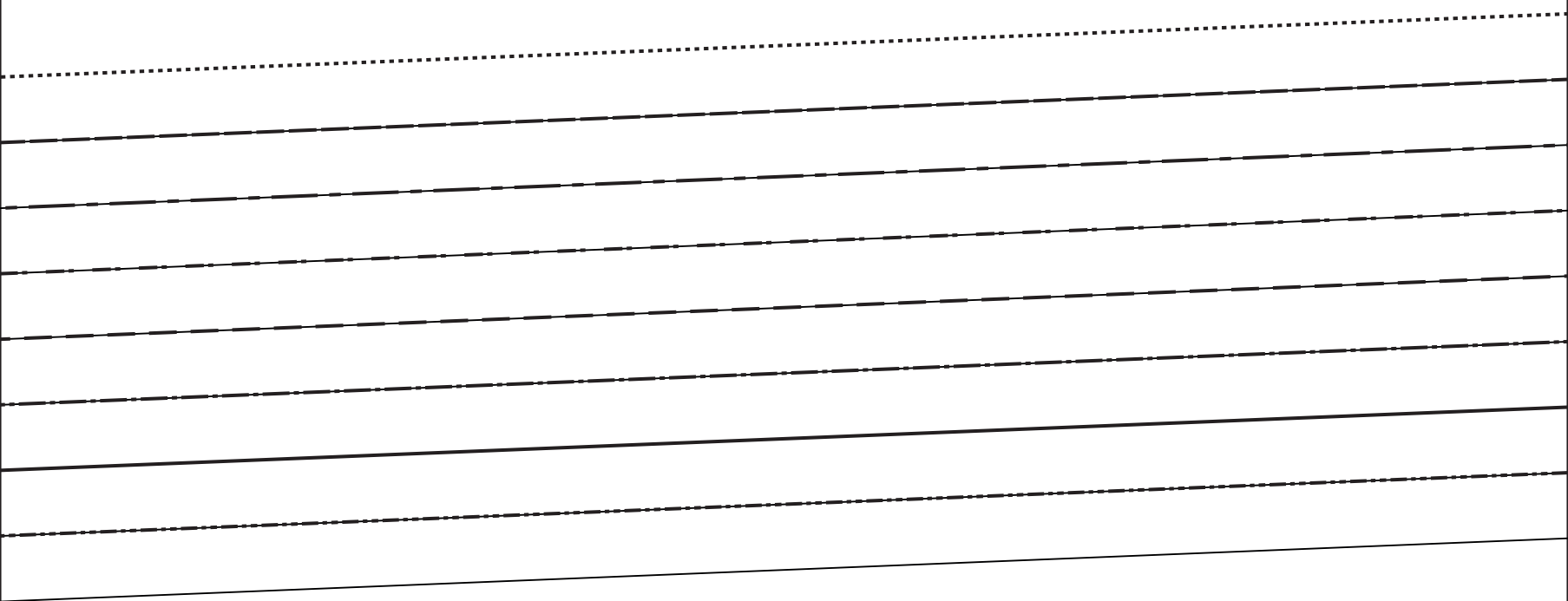

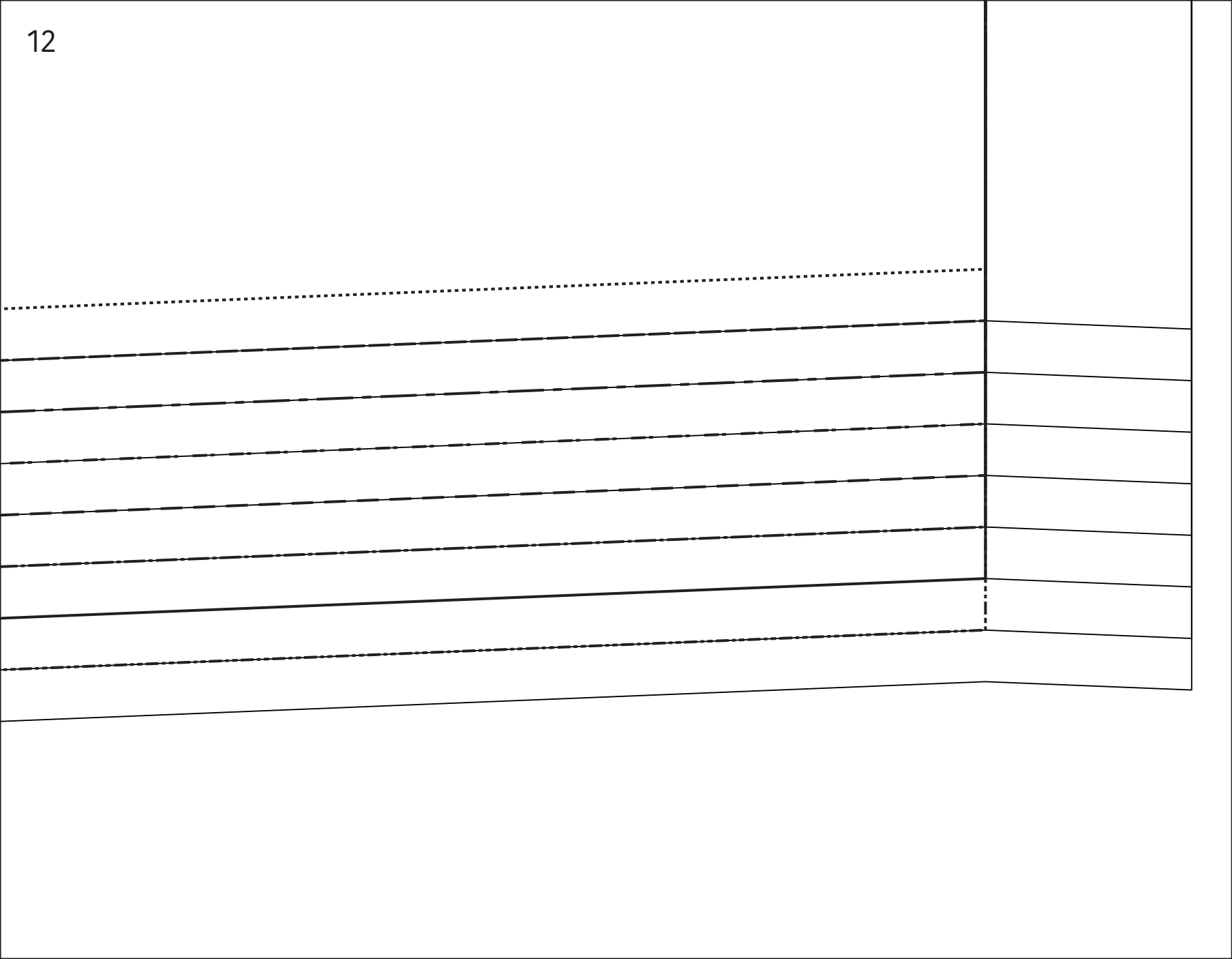



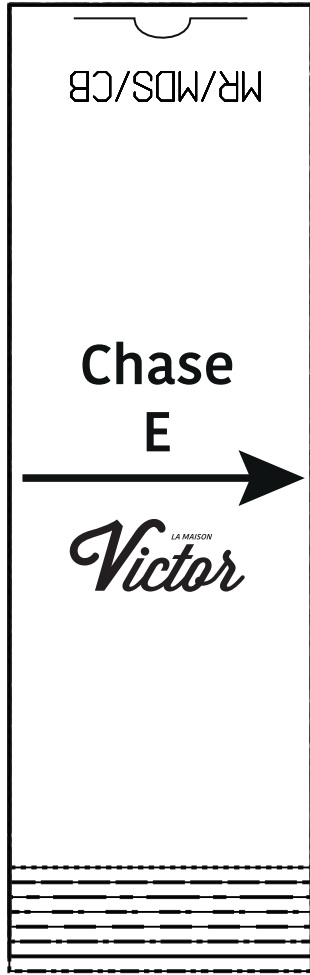

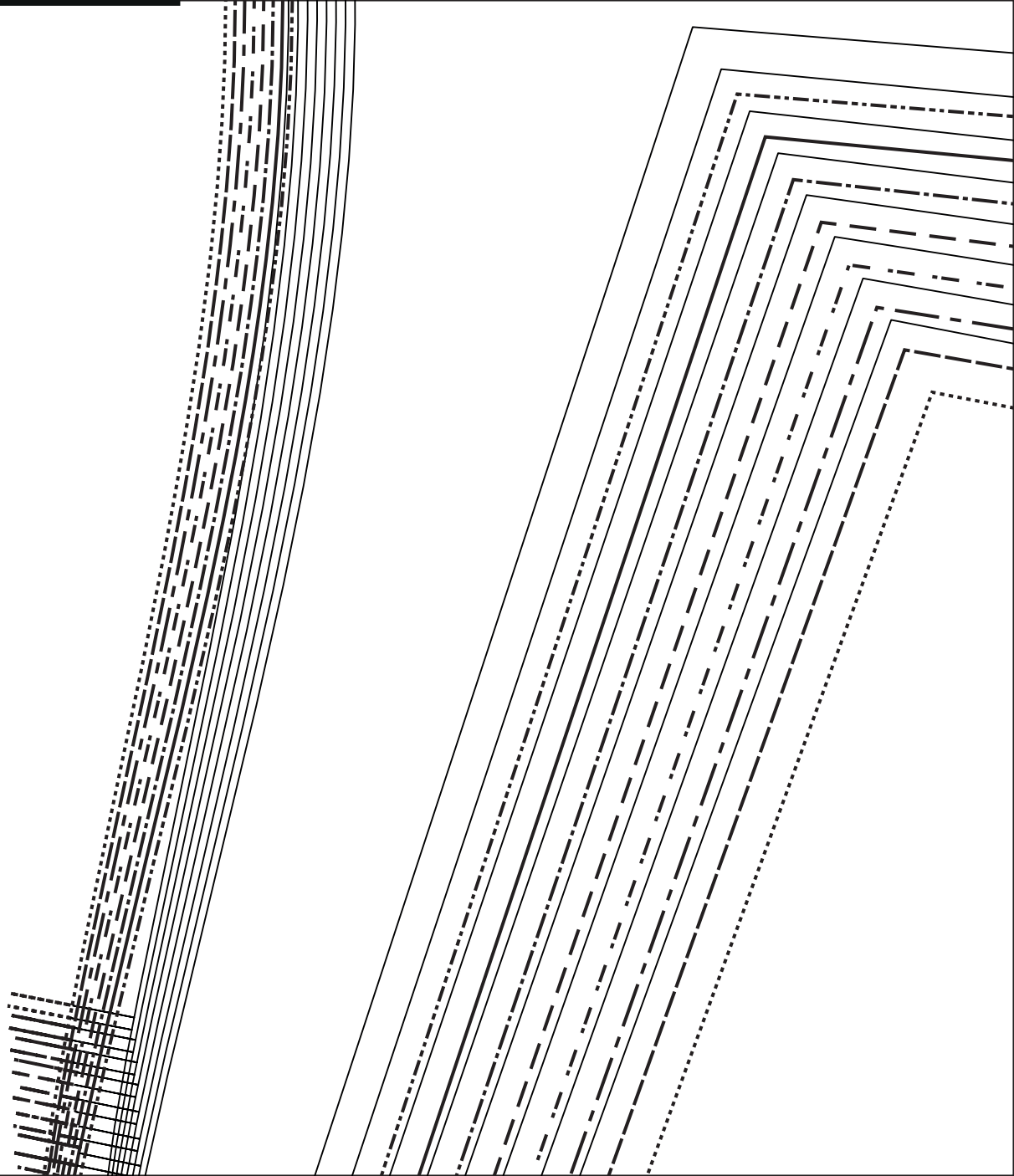

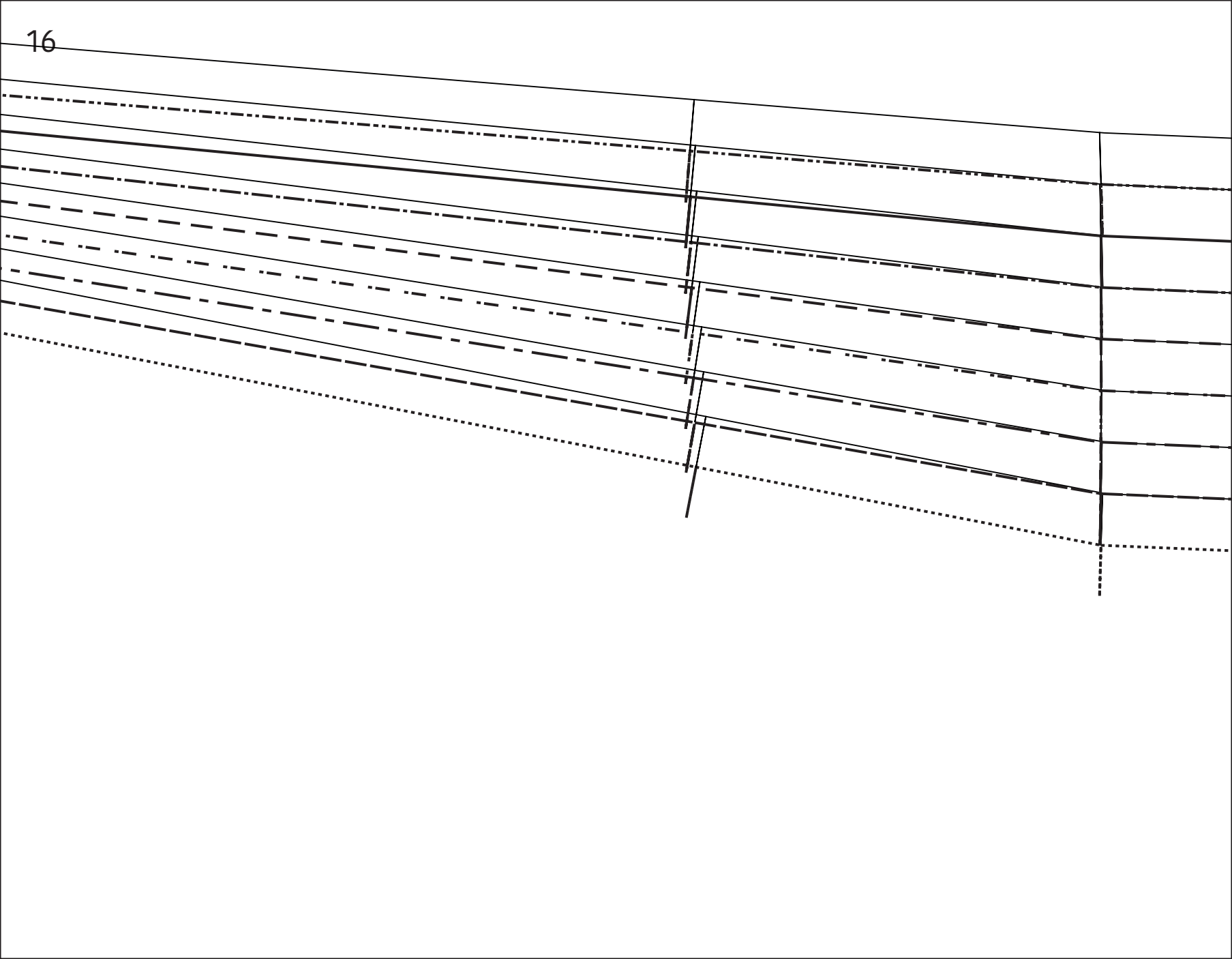



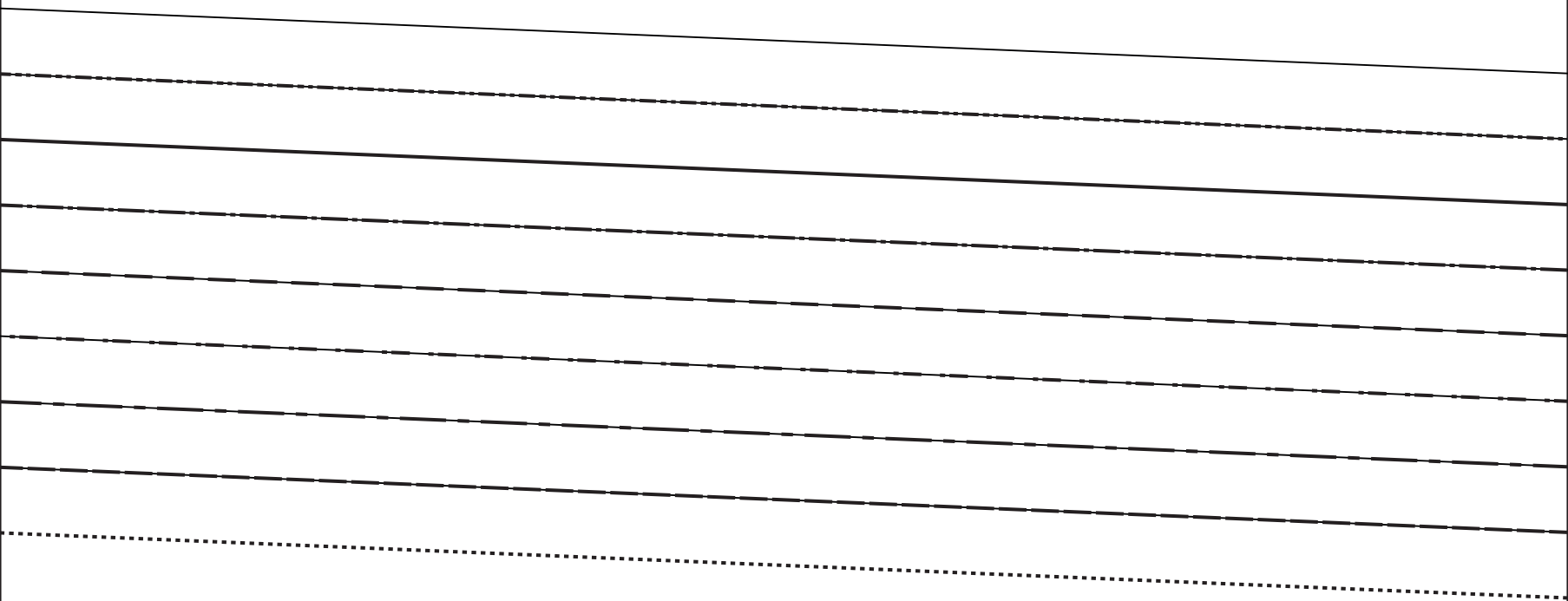

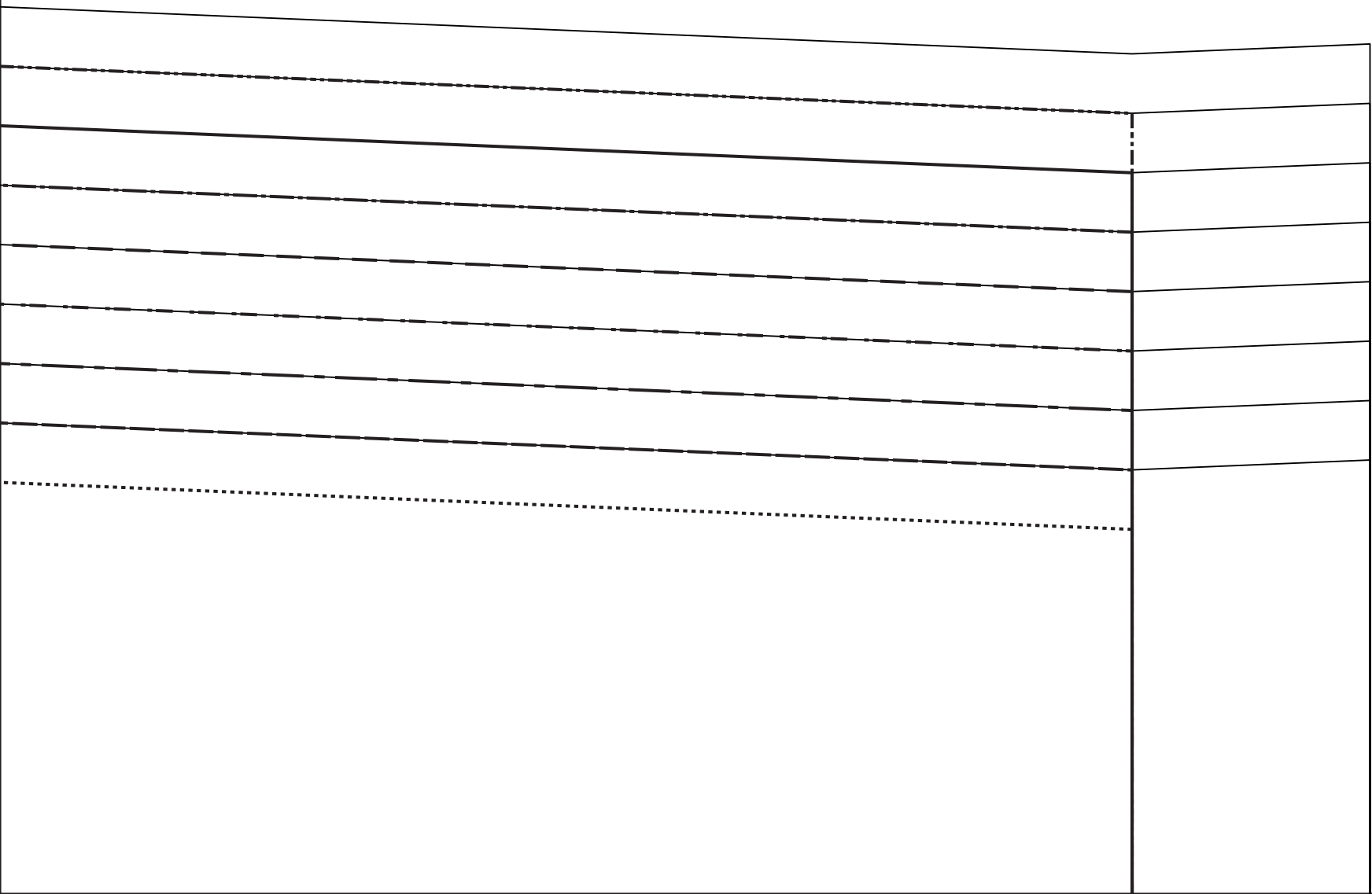



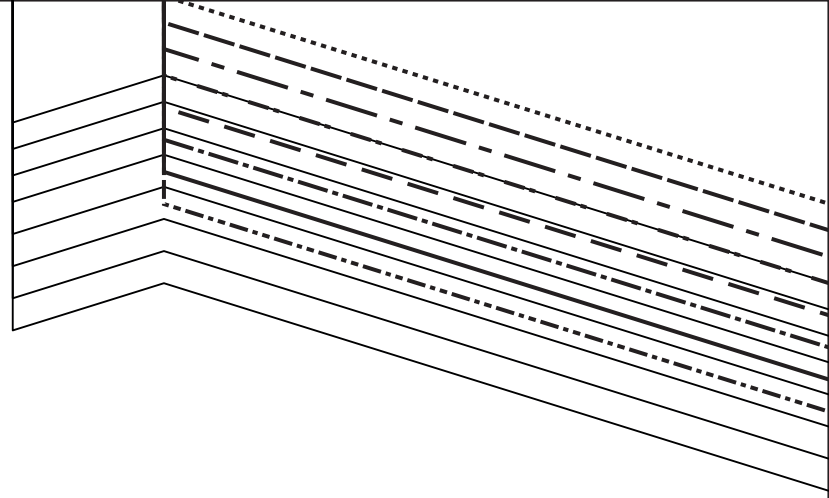

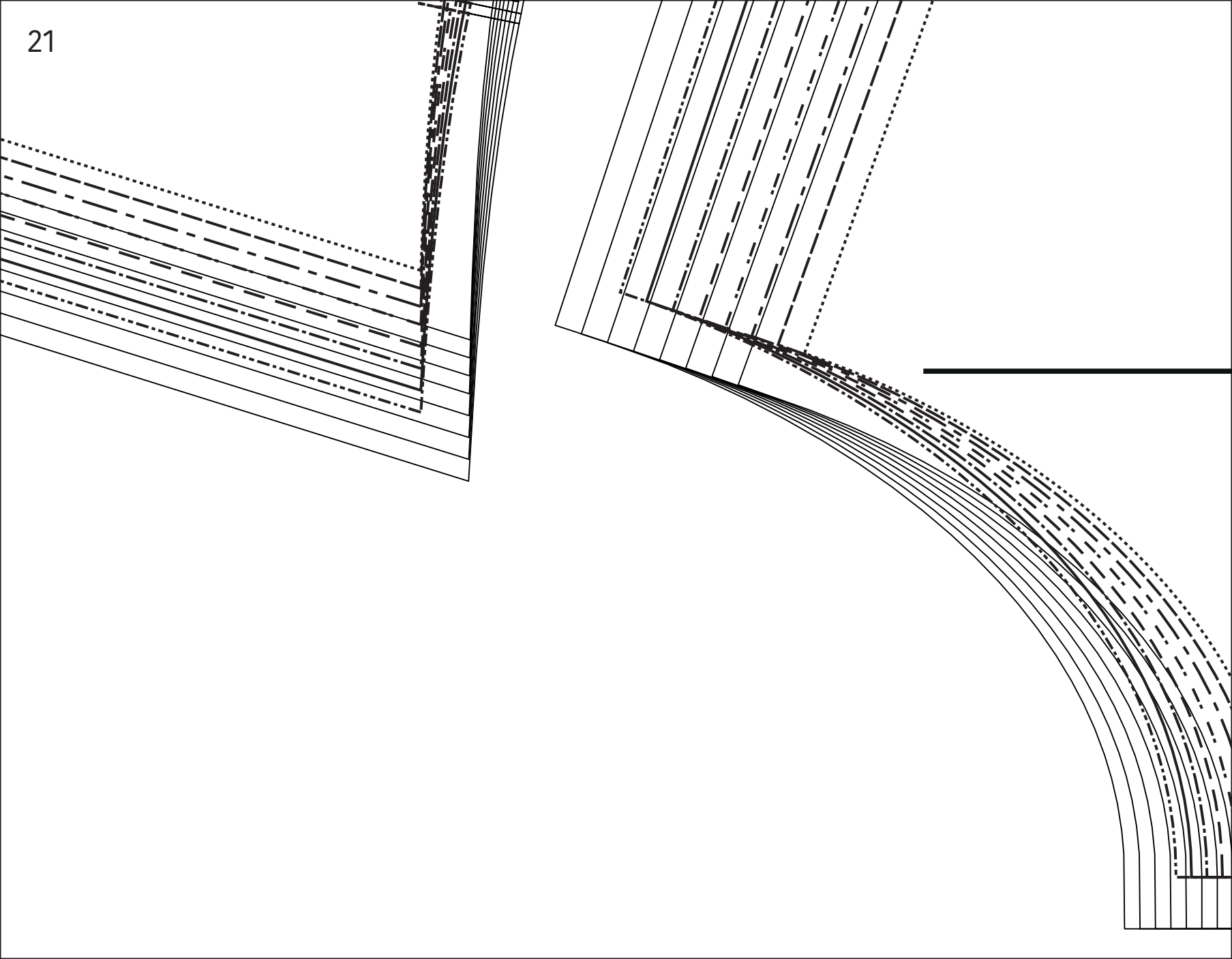

MV/MDV/CF

# Chase - A

---

*Victor* LA MAISON

---

---

