

Patroonschema / Schéma du Patron / Pattern Diagram /
Übersichtsplan zum Zusammenkleben

Johanna

Vest / Veste / Cardigan

Maten / Tailles / Sizes:

-----	34
- . - . - . - . - . - . - . - . - .	36
-----	38
- . - . - . - . - . - . - . - . - .	40
=====	42
- . - . - . - . - . - . - . - . - .	44
-----	46
- . - . - . - . - . - . - . - . - .	48
-----	50
- . - . - . - . - . - . - . - . - .	52
=====	54
- . - . - . - . - . - . - . - . - .	56

Patroondelen / Pièces du patron / Pattern pieces:

- A** voorpand / devant / front panel
- B** rugpand / dos / back panel
- C** kraag / col / neckline
- D** mouw / manche / sleeve
- E** zak / poche / pocket
- F** mouwboord / bord manchette /
sleeve hem

1	2	3	4	5	6
X 7	8	9	10	11	12
13	14	15	16	17	18
19	20	21	22	23	24
25	26	27	28	29	30
31	32	33	34	35	36
37	38	39	40	41	

Controlevierkant / Carré de controle / Test square / Kontrollquadrat

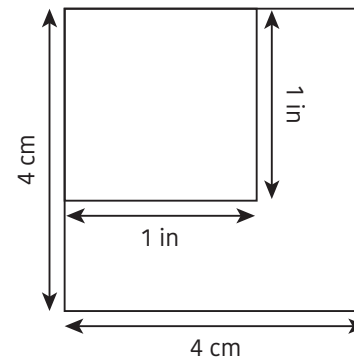

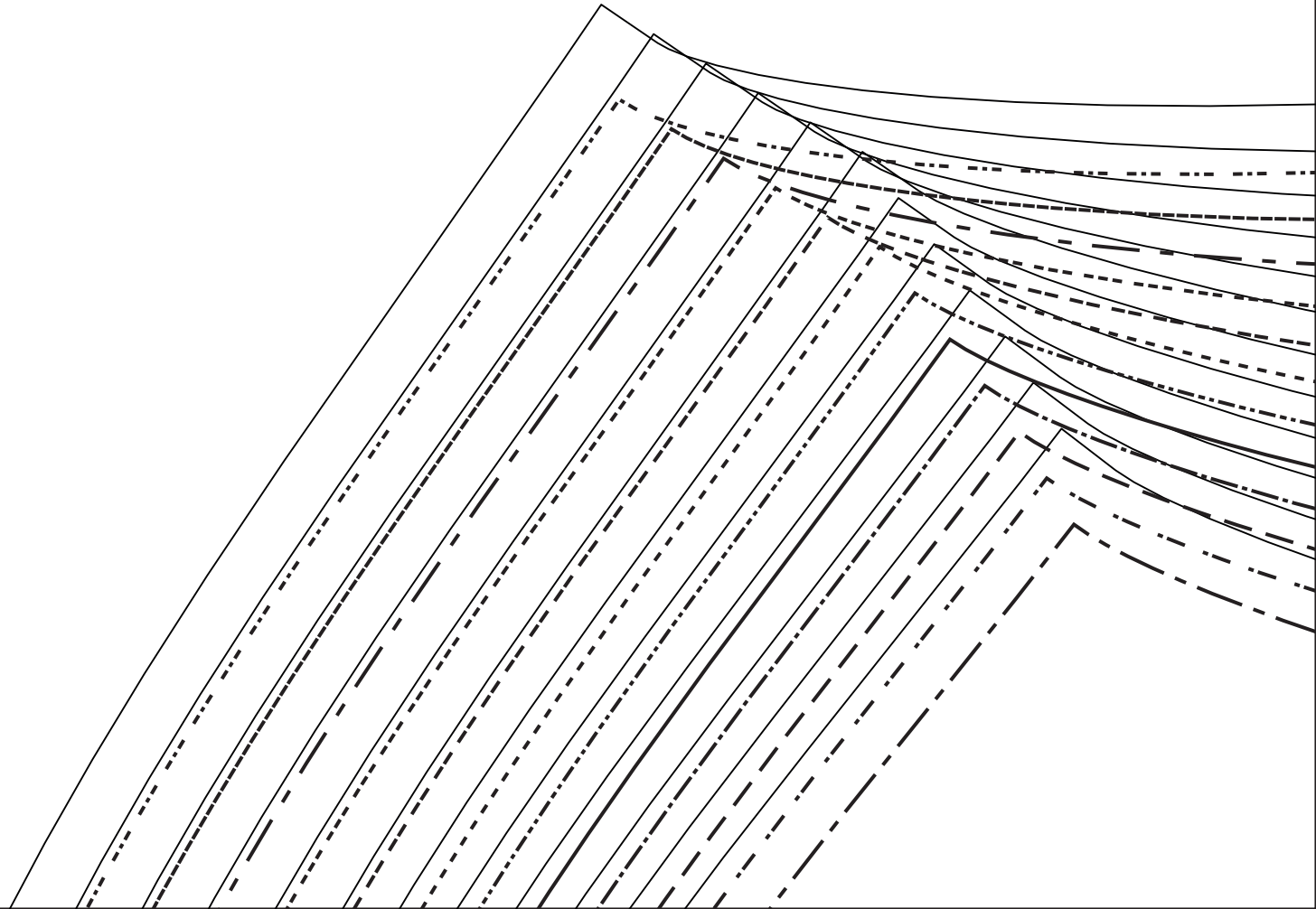

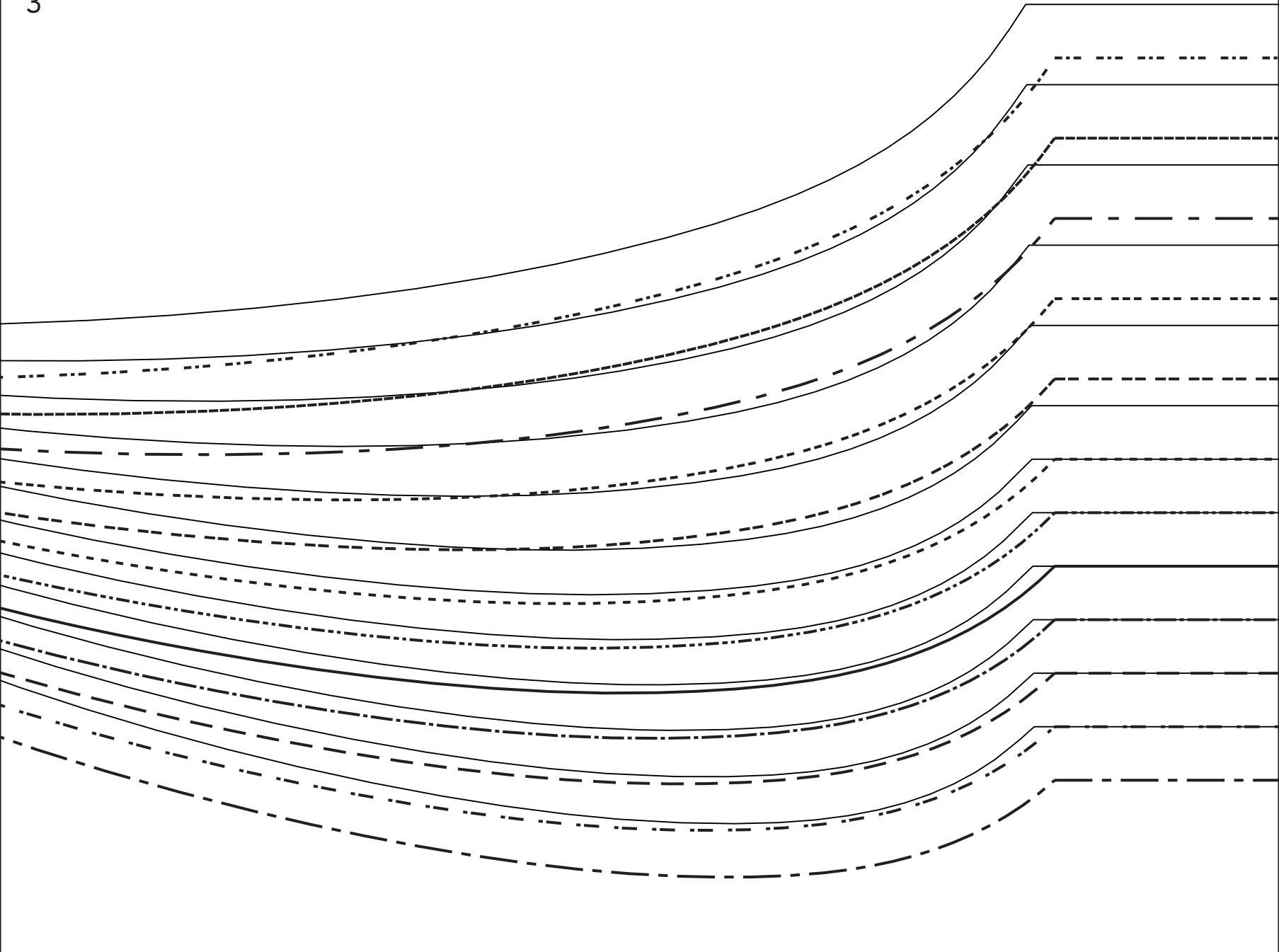

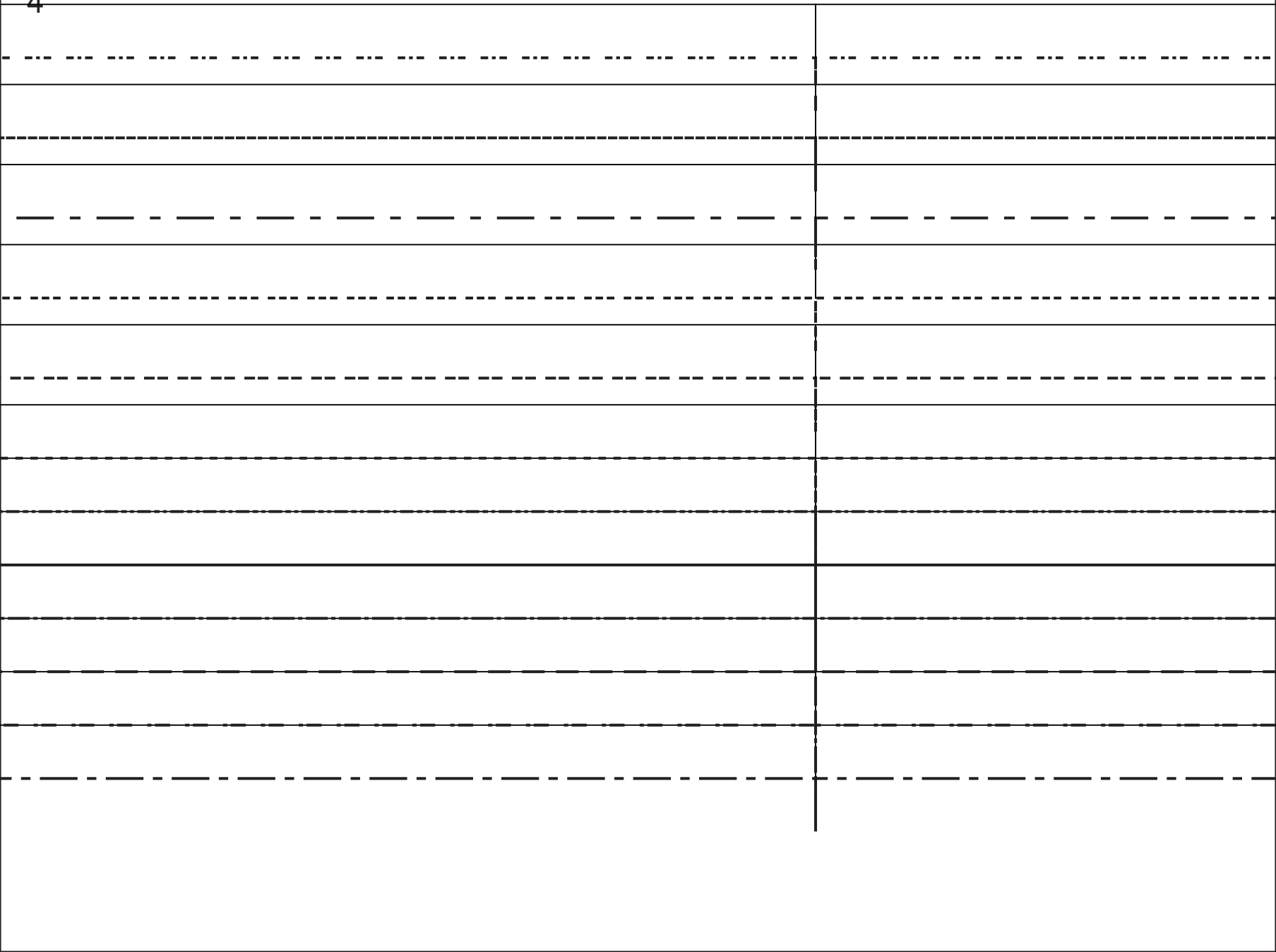

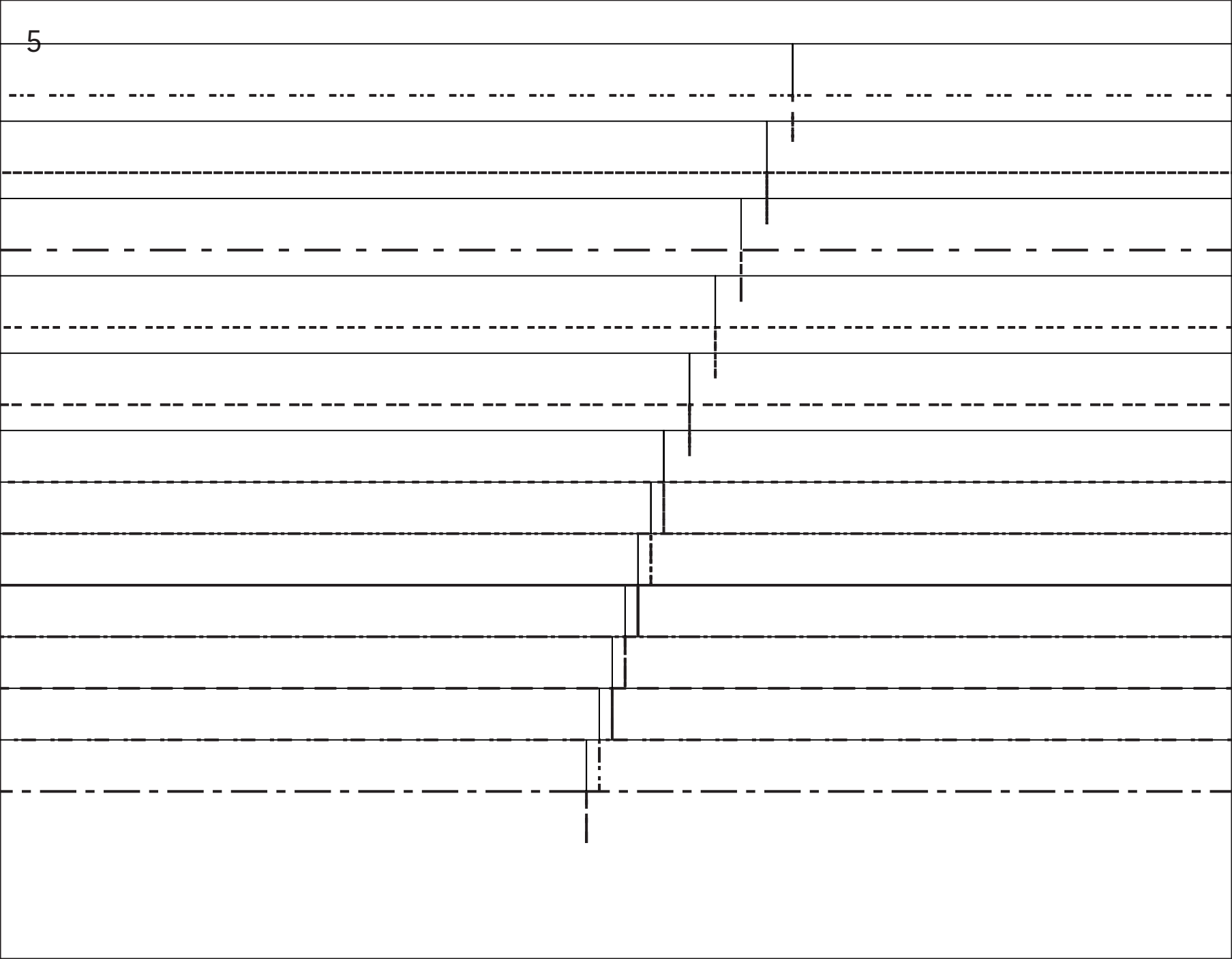

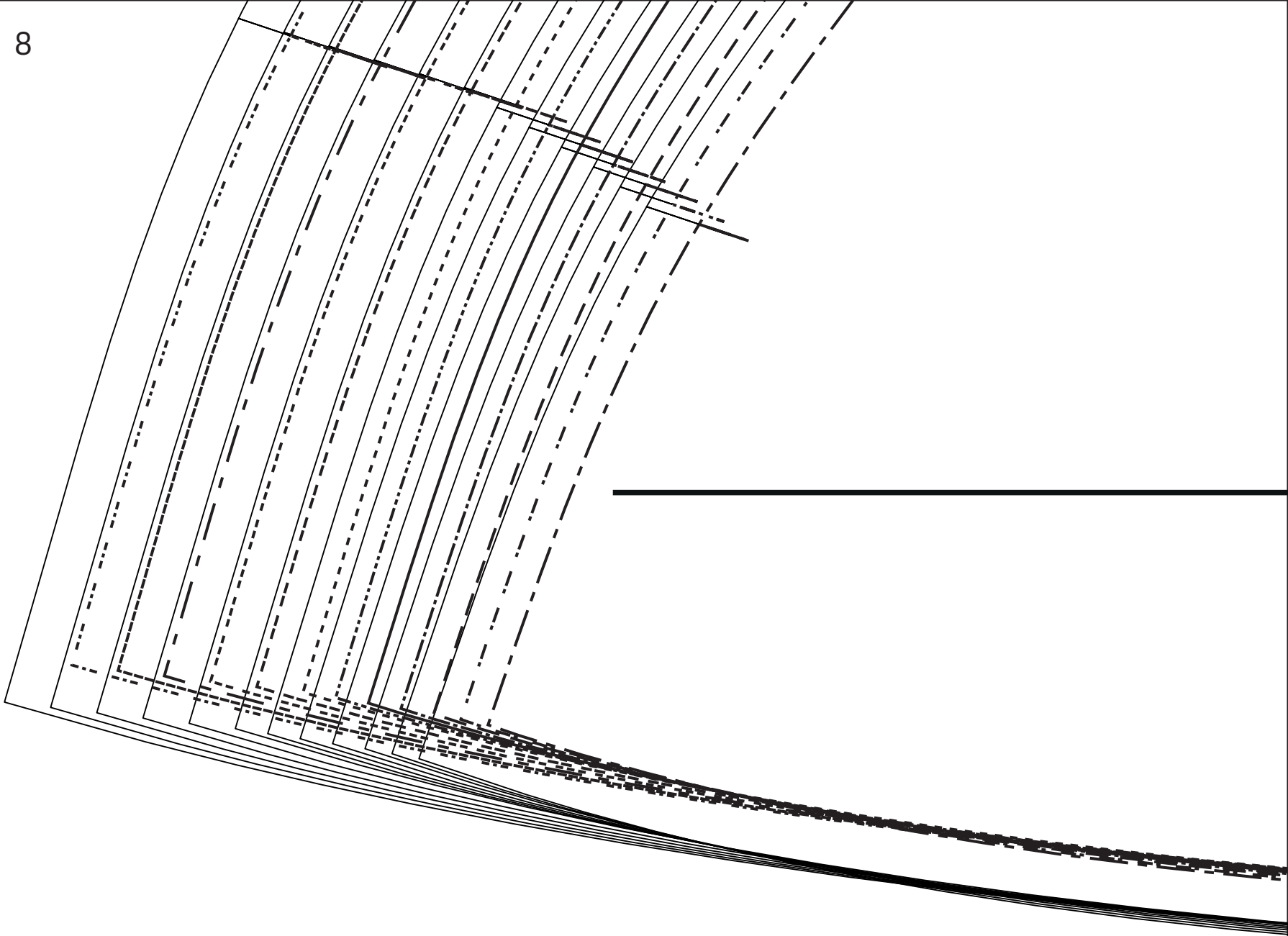



Johanna - A

LA MAISON
Victor





12



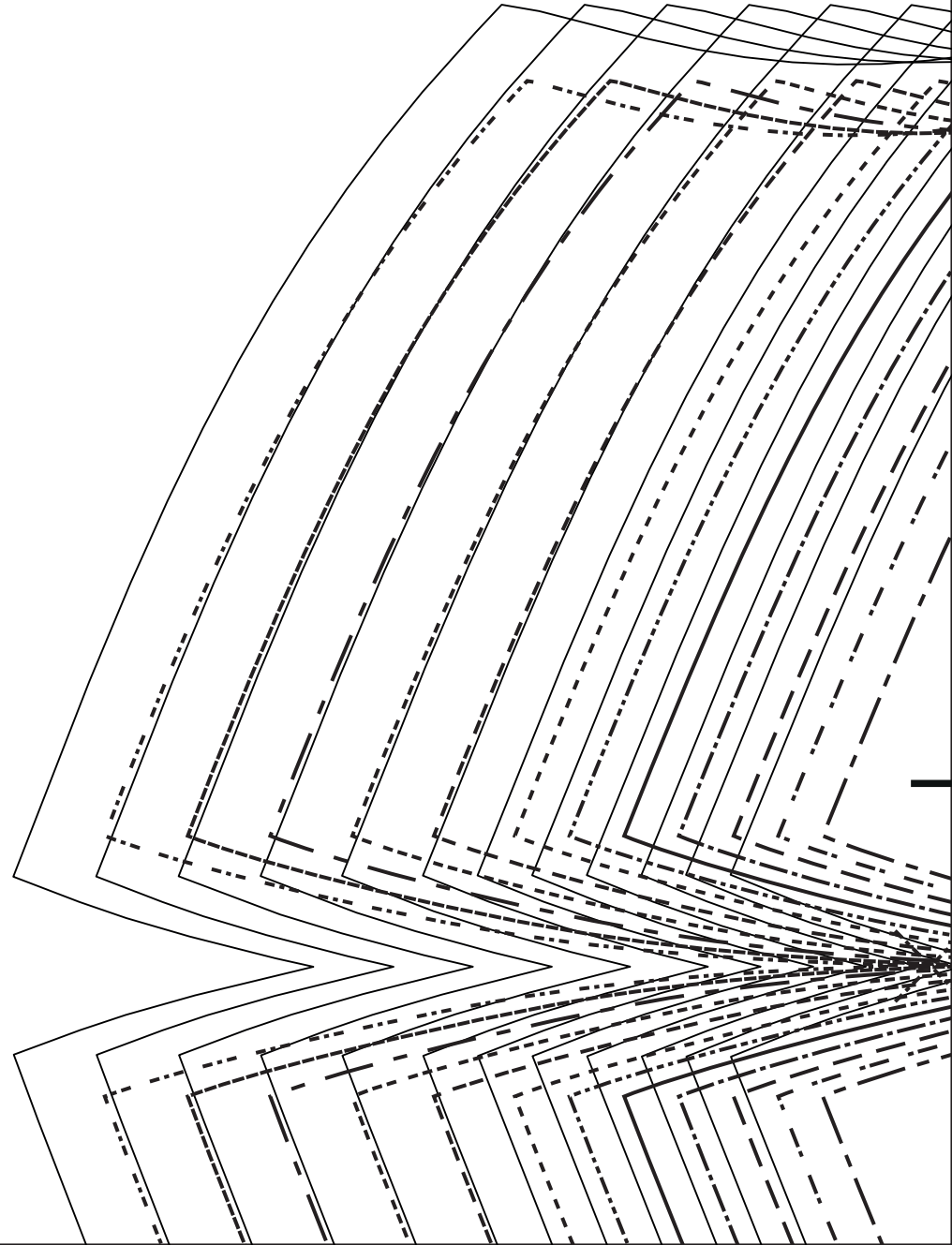

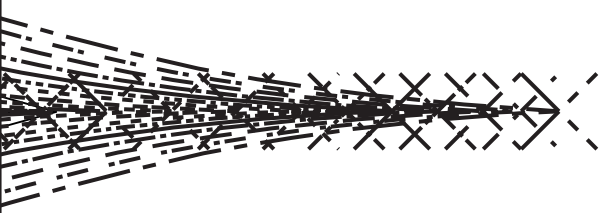
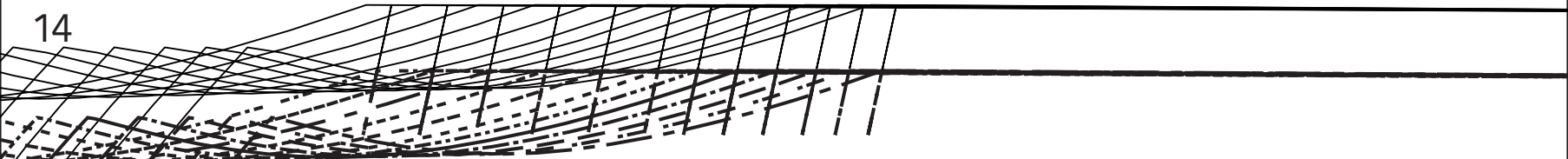

ohanna - C

Victor
LA MAISON

|



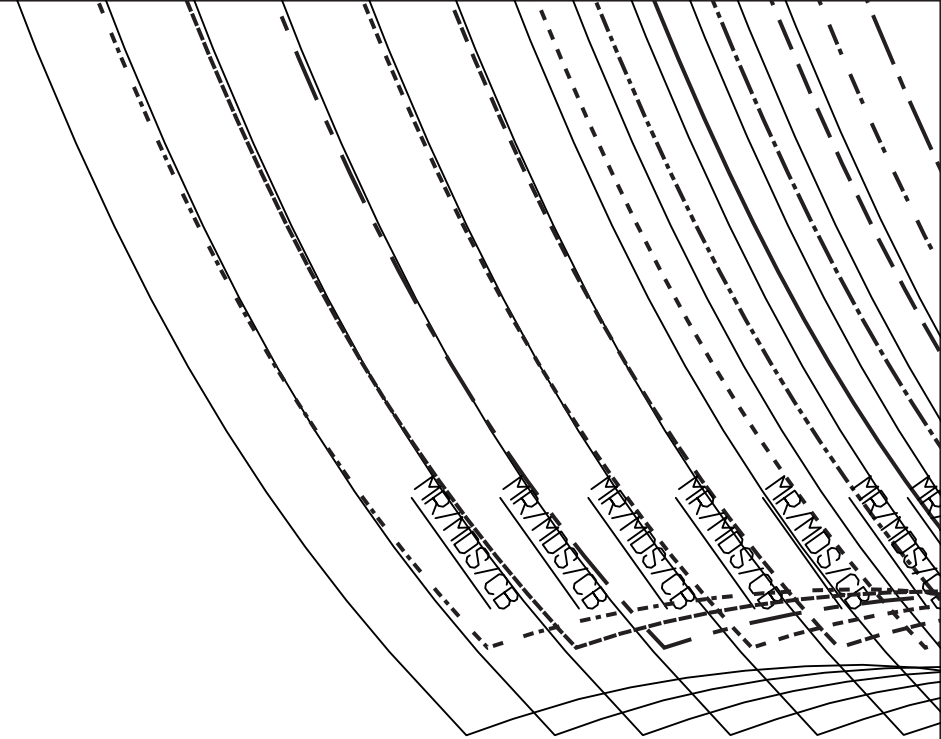

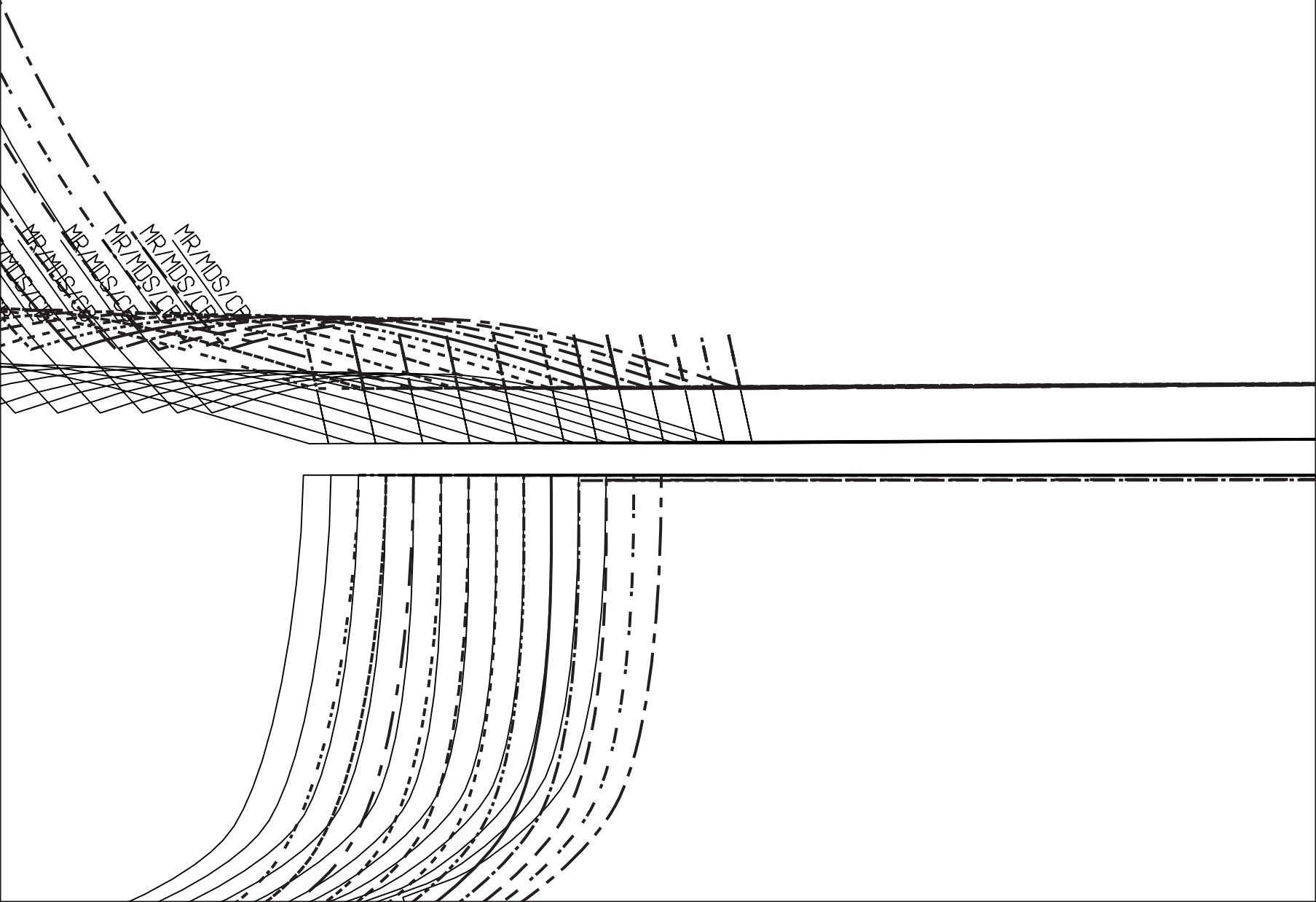

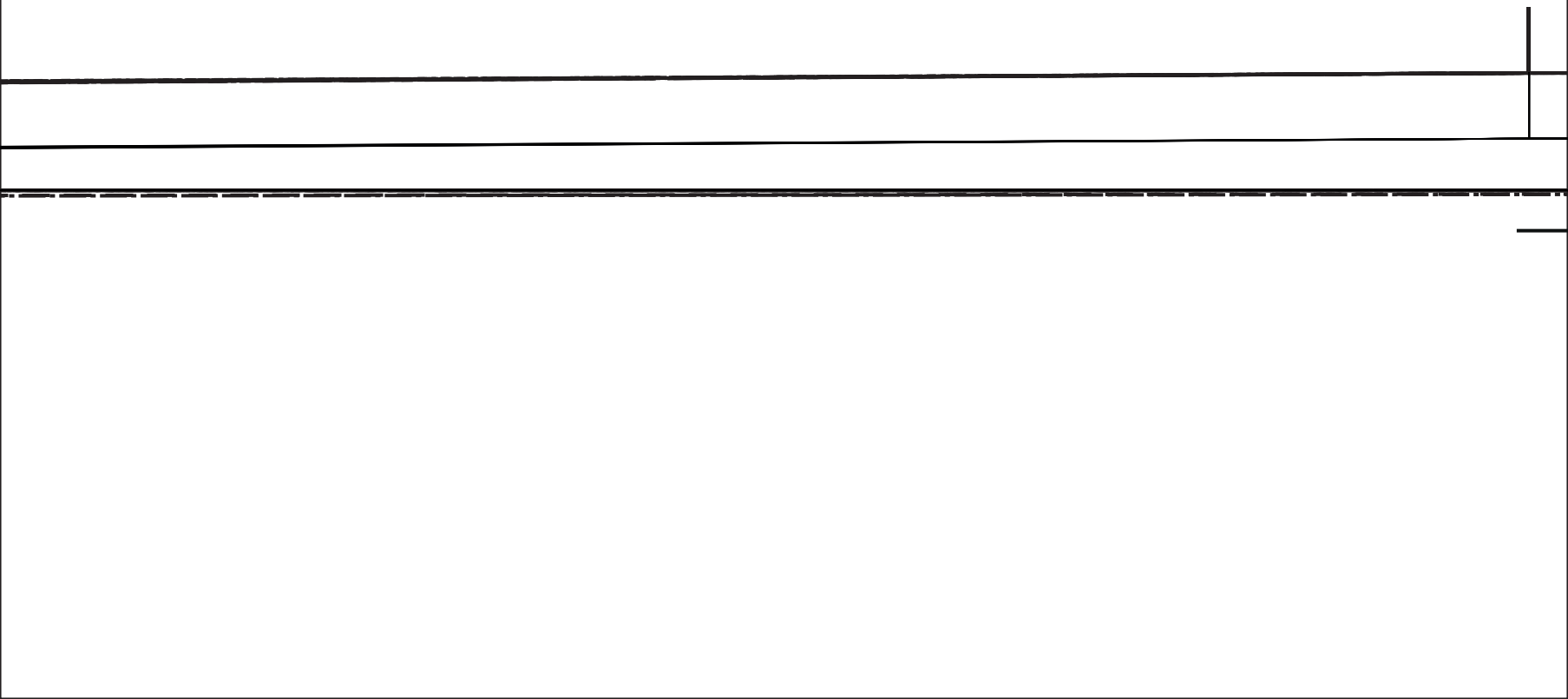

MR/MDS/CB

Johanna - B

1

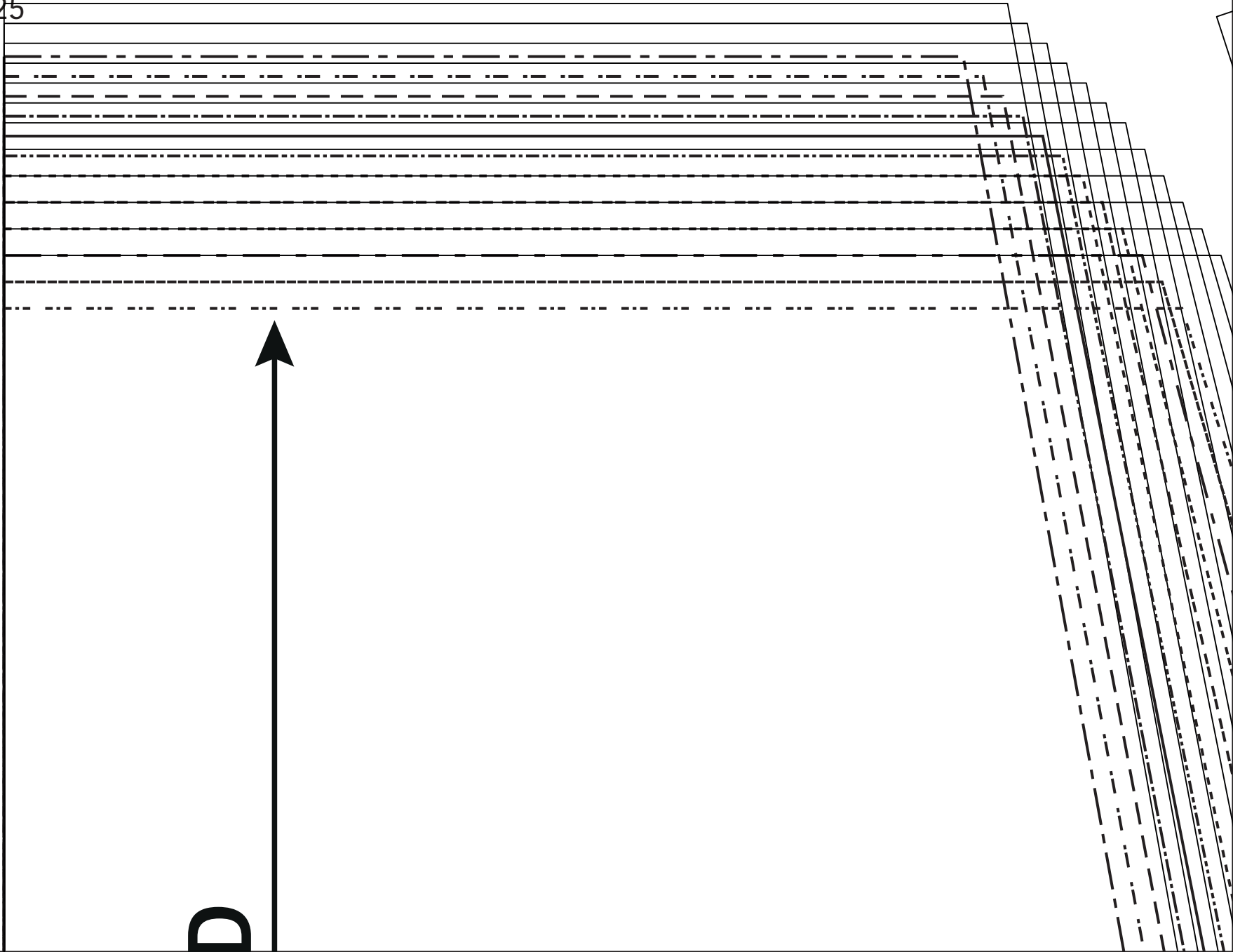

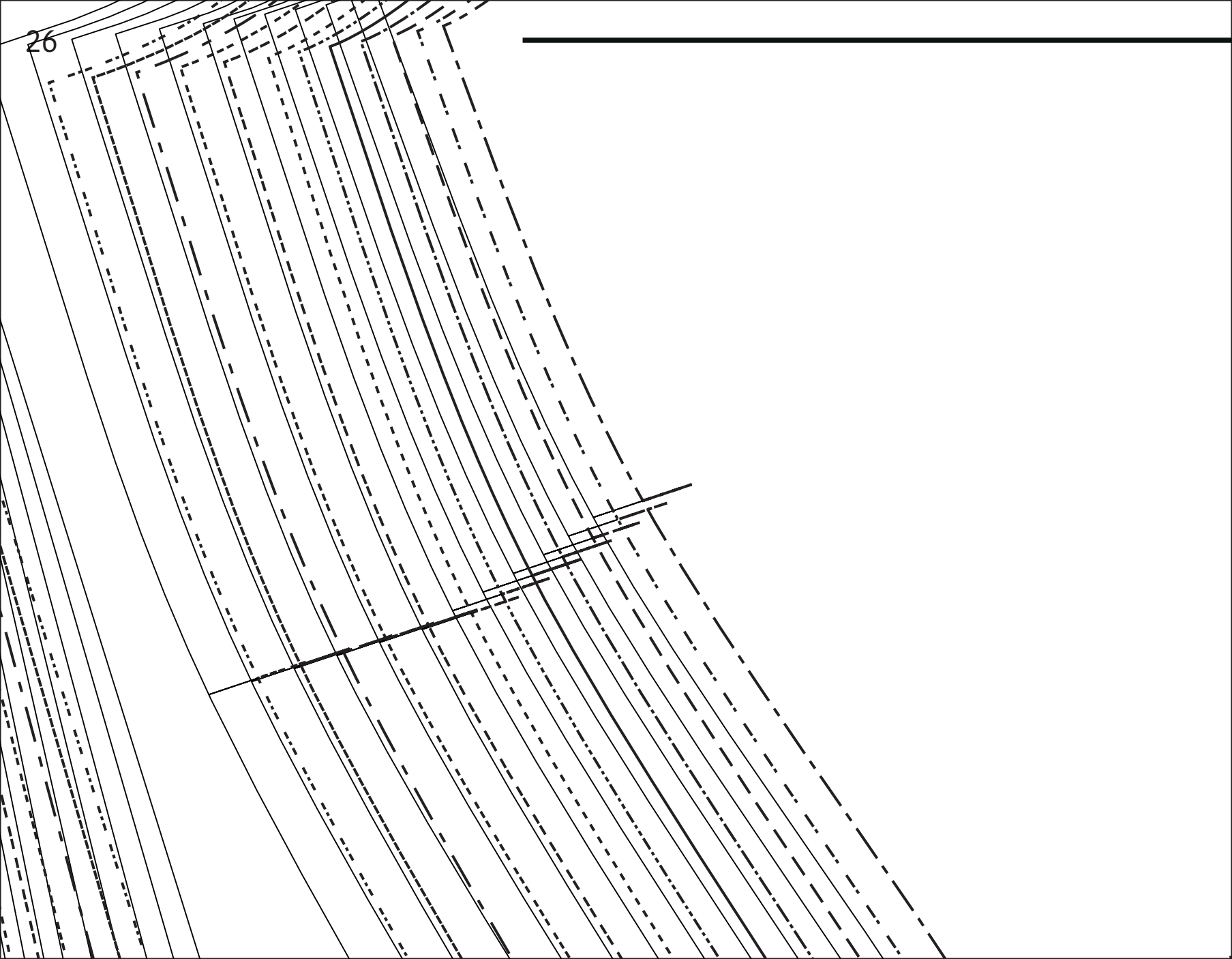

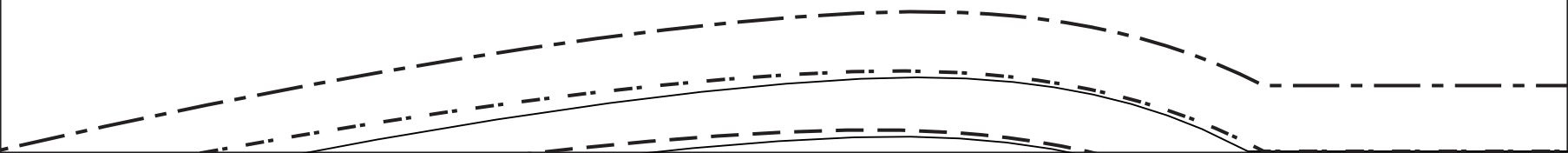

Victor
LA MAISON



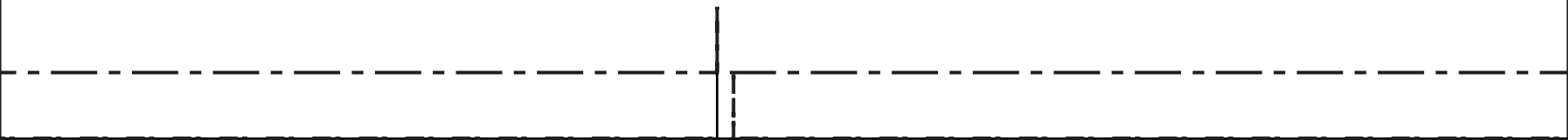

30

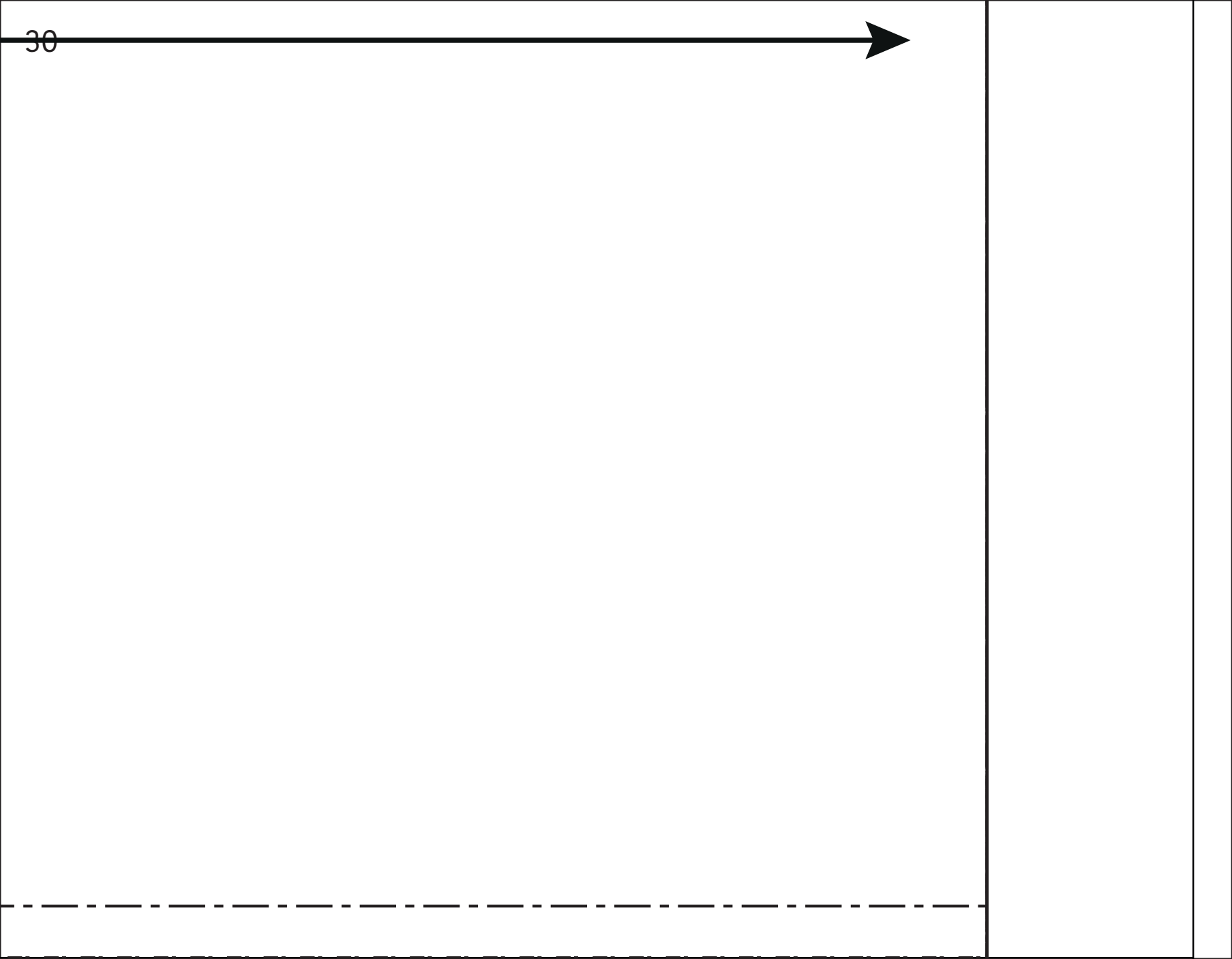



Johanna -

LA MAISON
Victor

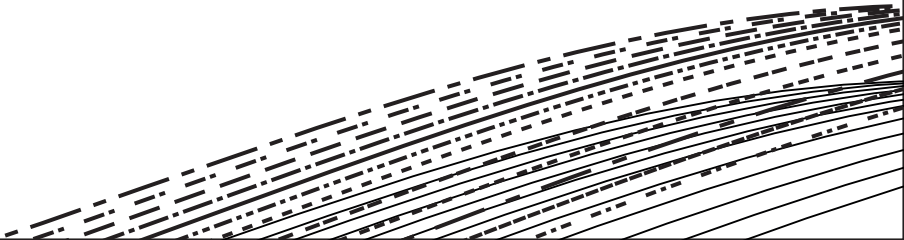

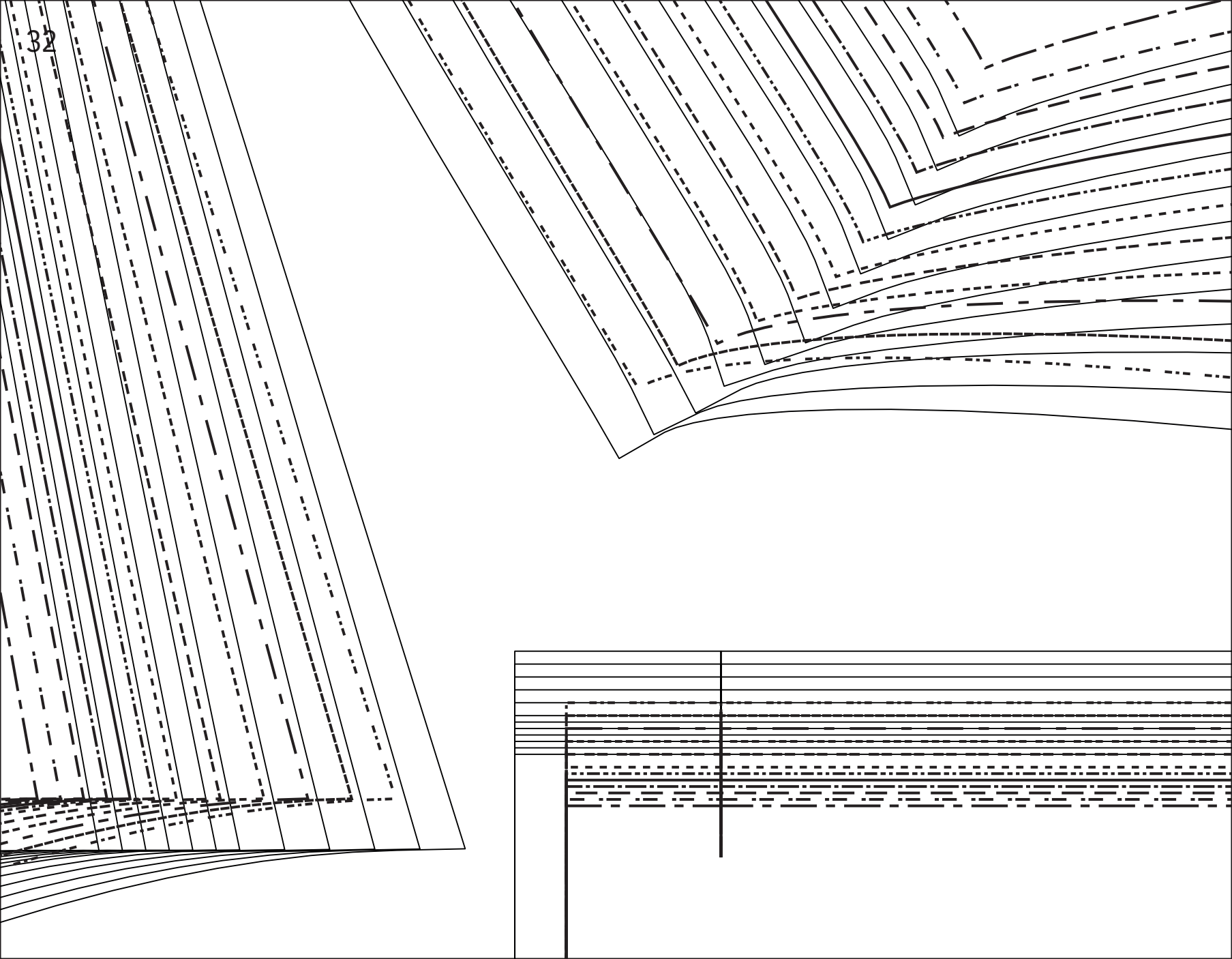

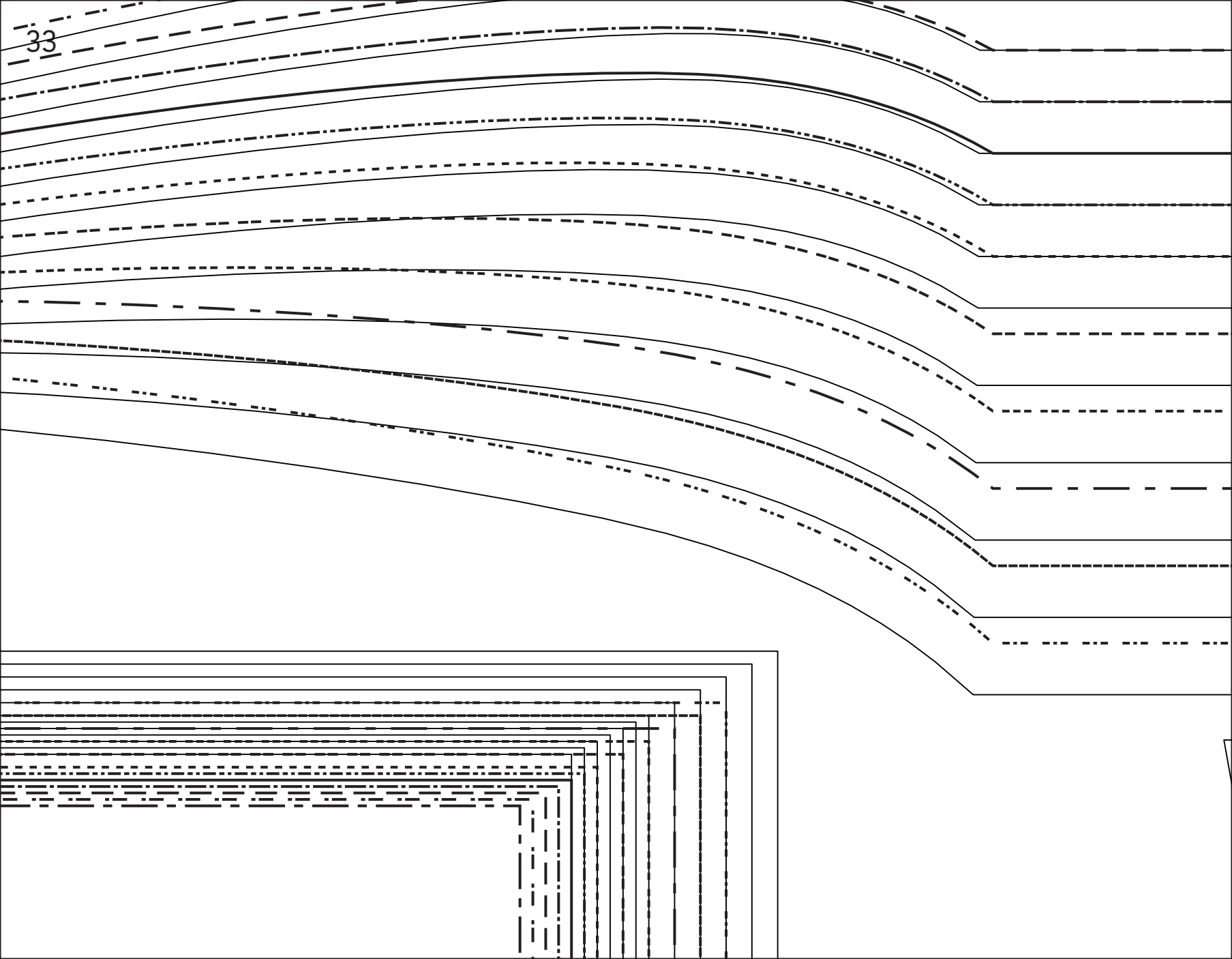

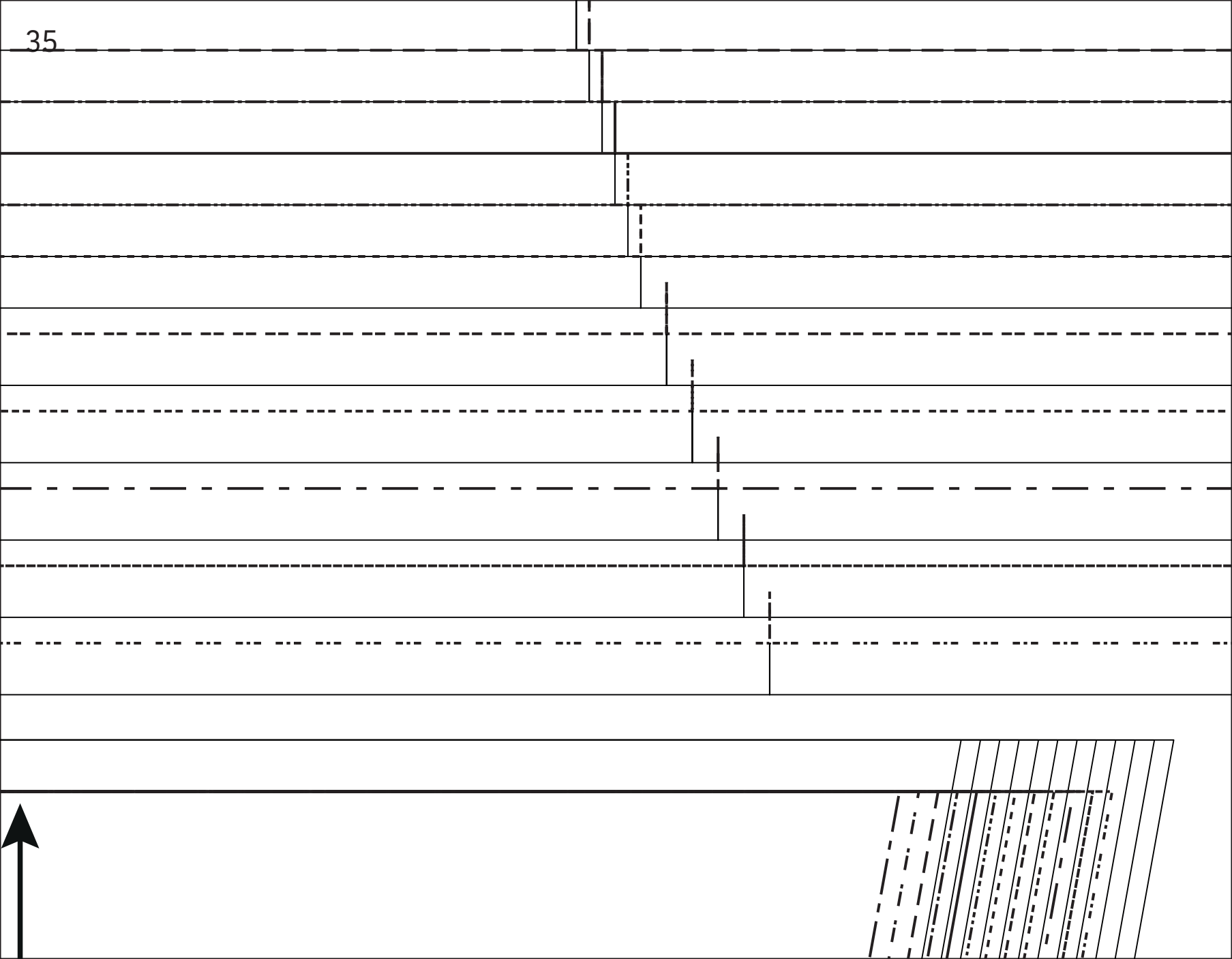

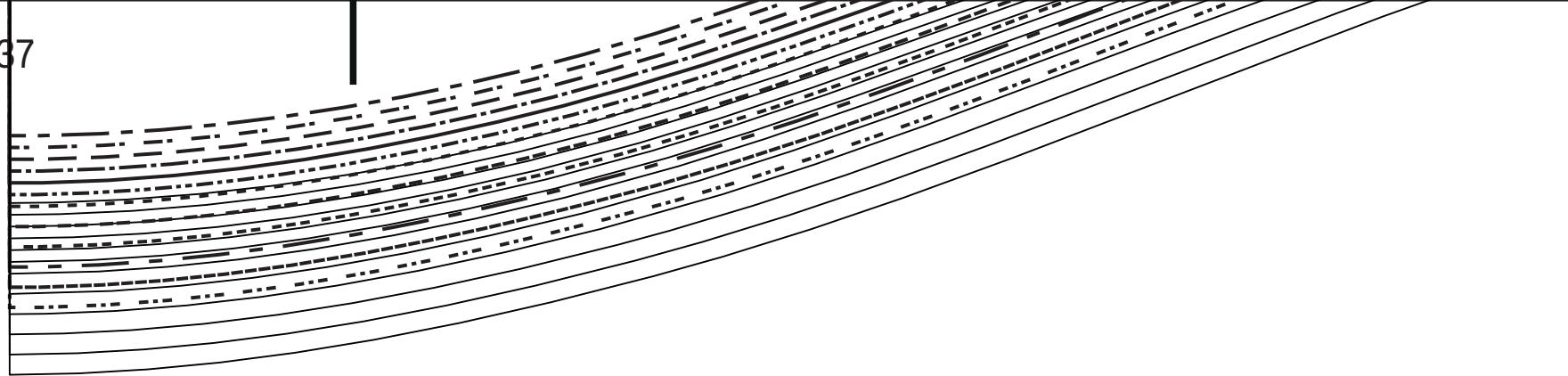

Johanna

Vict
LA

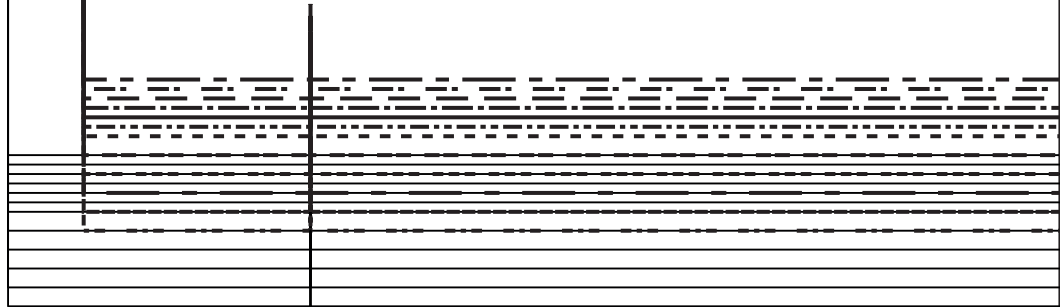

a - E



MAISON

for

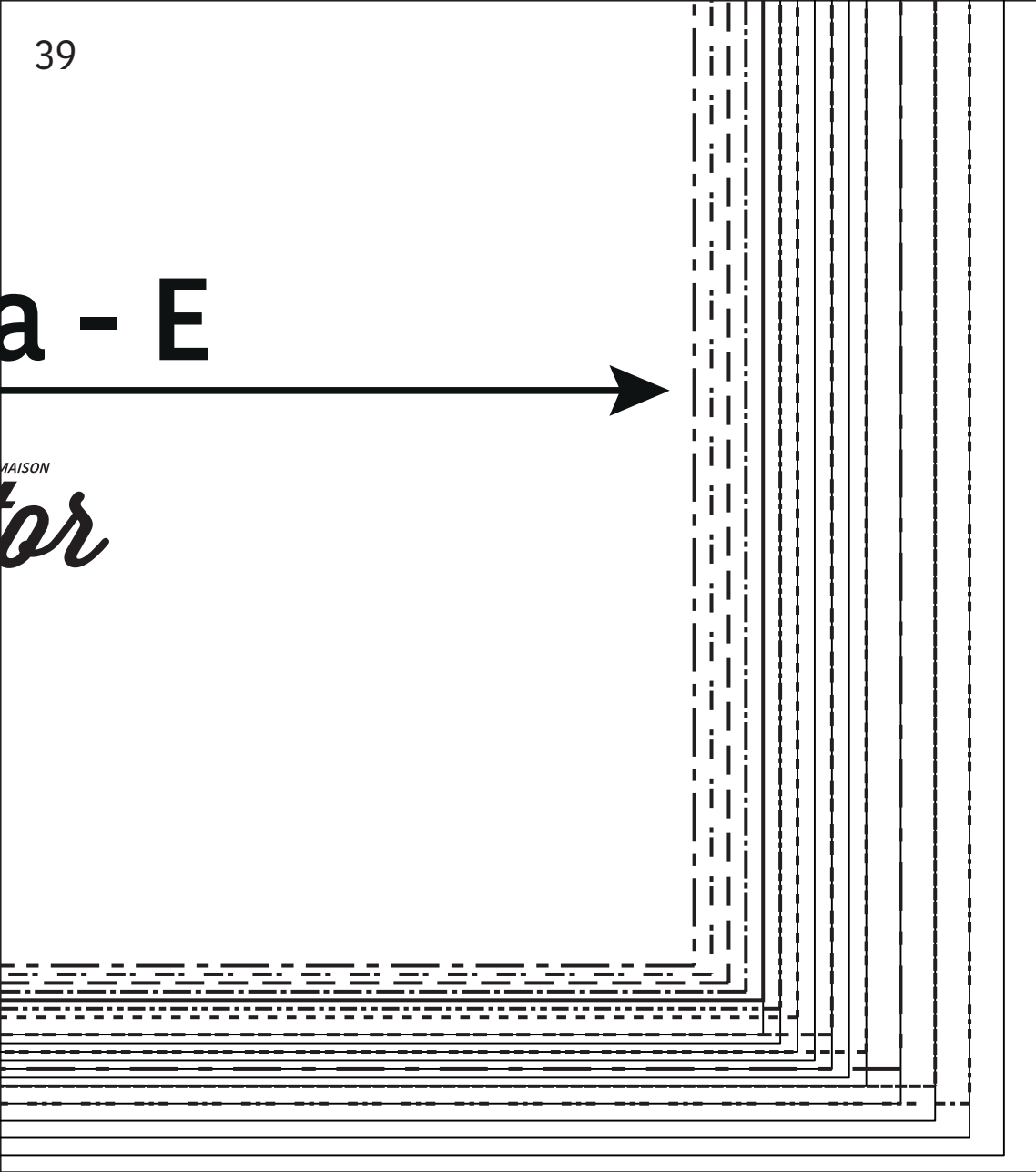

40

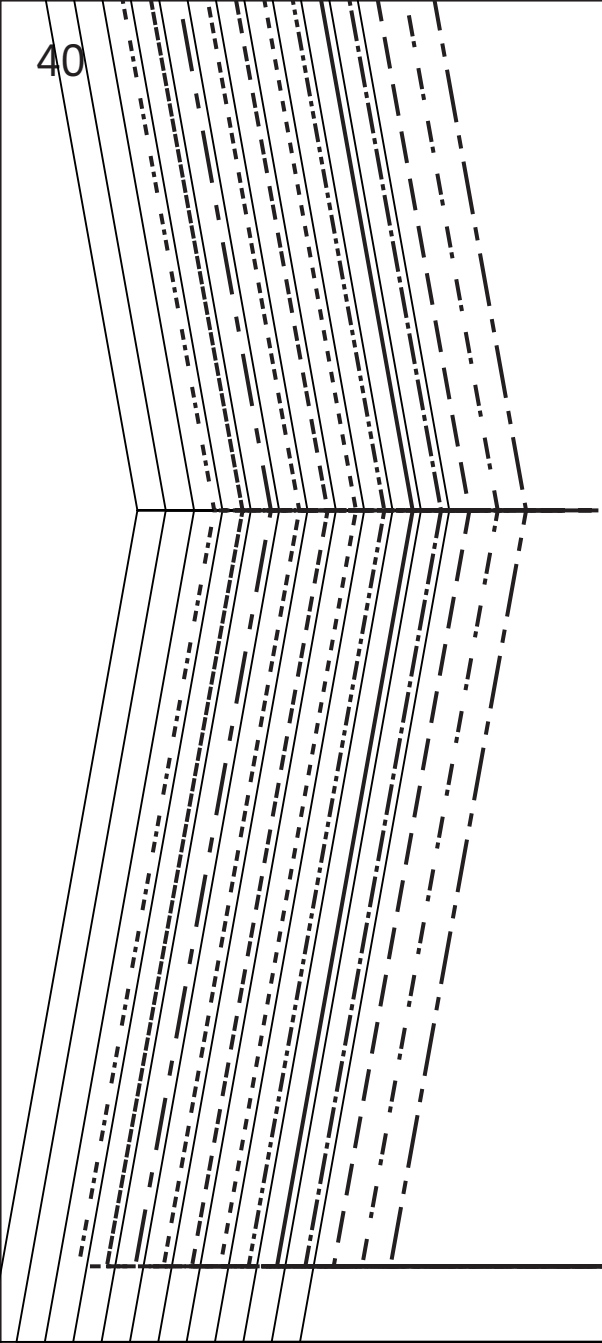

Johanna - F

LA MAISON
Victor

