

# Anastasia

## Jurk / Robe / Dress

### Maten / Tailles / Sizes:

-----	34
- - - - -	36
-----	38
- - - - -	40
=====	42
- - - - -	44
-----	46
- - - - -	48
- - - - -	50
-----	52
- - - - -	54
.....	56

### Patroondelen / Pièces du patron / Pattern pieces:

- A** voorpand / devant / front panel
- B** rugpand / dos / back panel
- C** beleg VP / parementure DV /  
facing FP
- D** beleg RP / parementure DS /  
facing BP

## Patroonschema / Schéma du Patron / Pattern Diagram / Übersichtsplan zum Zusammenkleben

1	2	3	4	5	6	7
8	9	10	11	12	13	14
15	16	17	18	19	20	21
22	23	24	25	26	27	28
29	30	31	32	33	34	

### Controlevierkant / Carré de controle / Test square / Kontrollquadrat

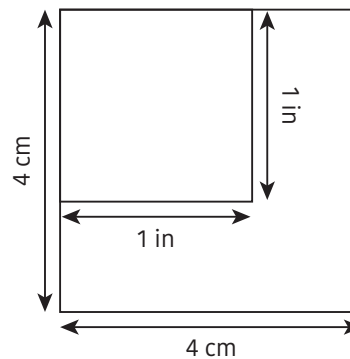

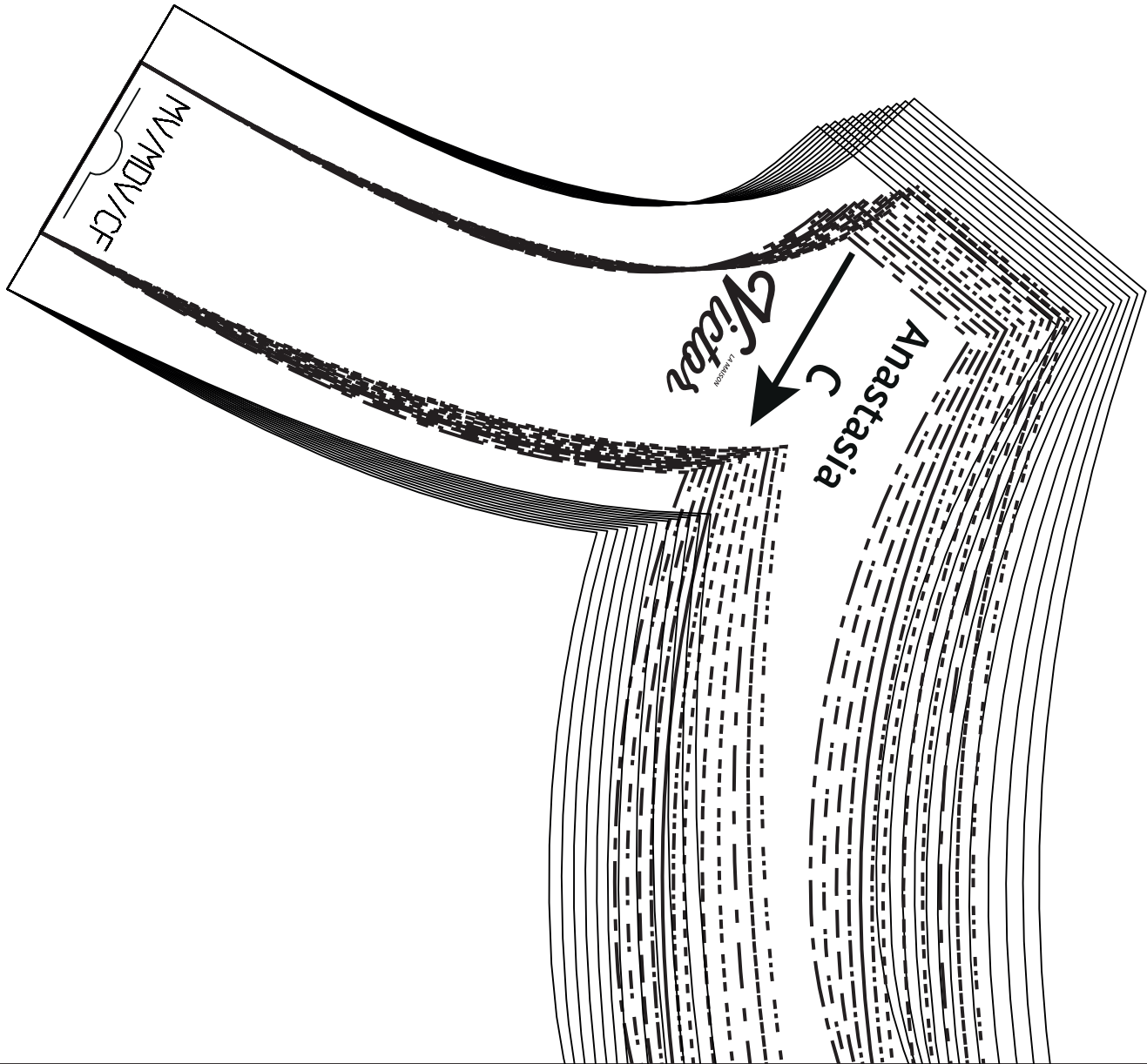

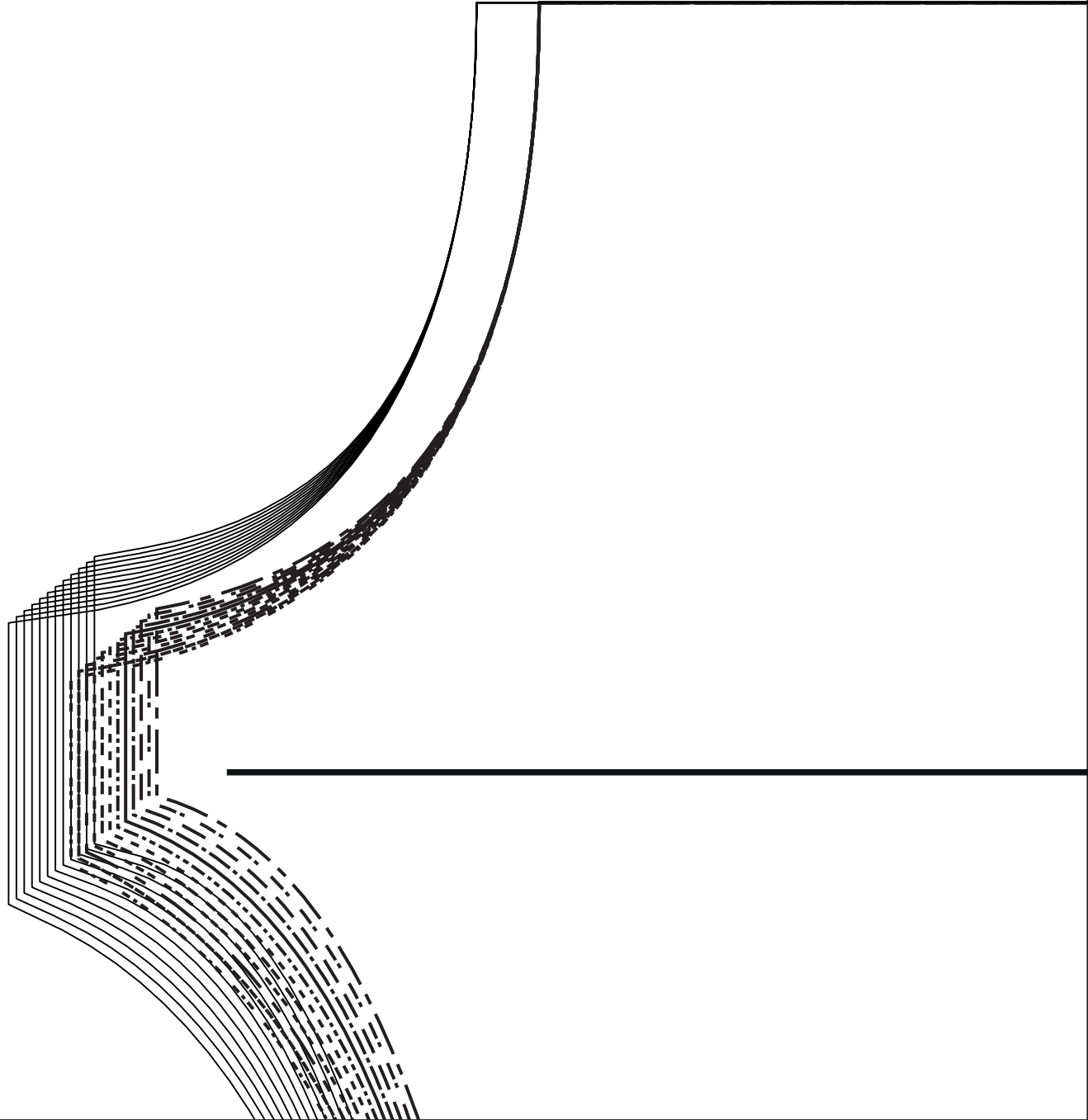

MR/MDS/CB



# Anastasia - B

LA MAISON  
*Victor*



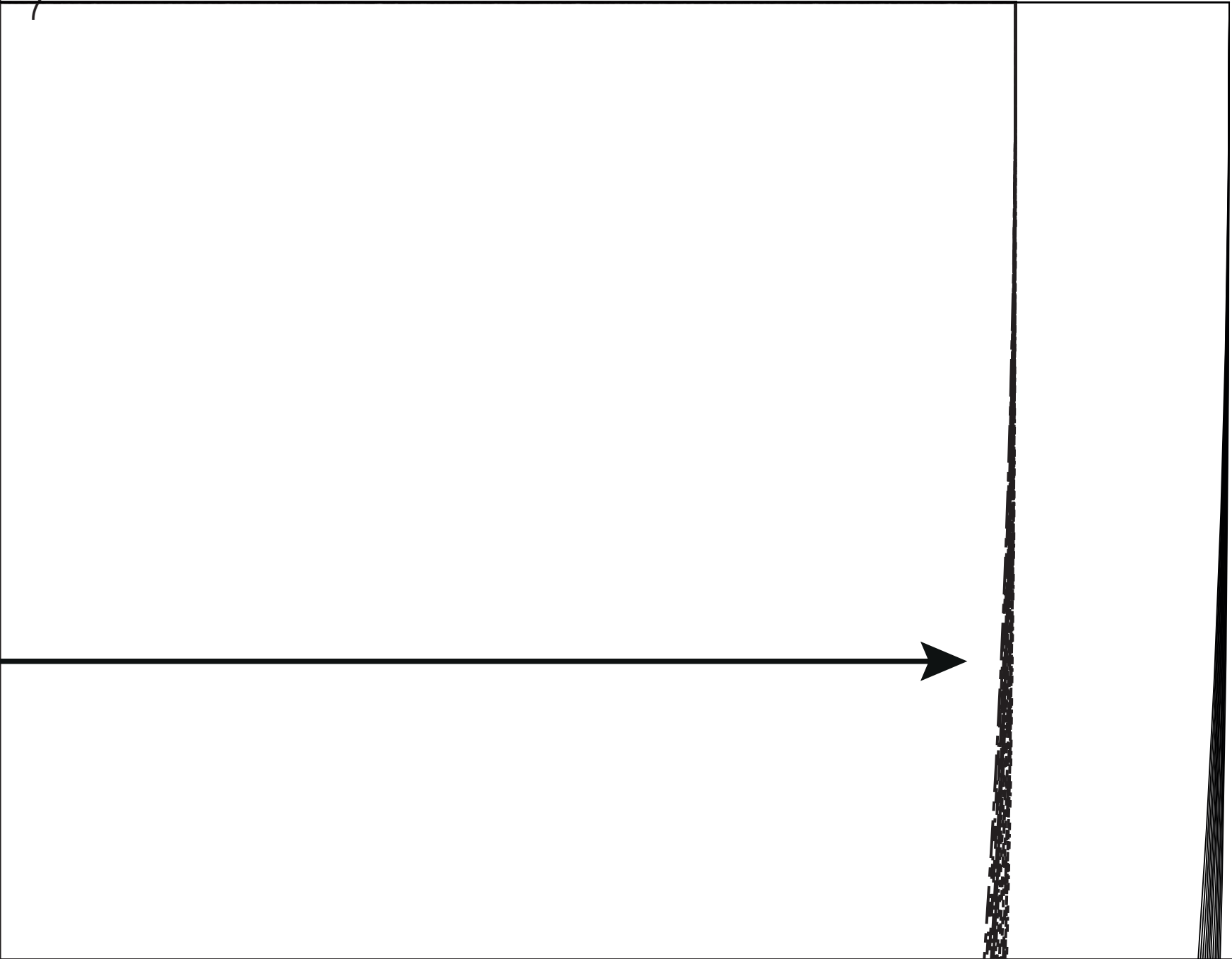

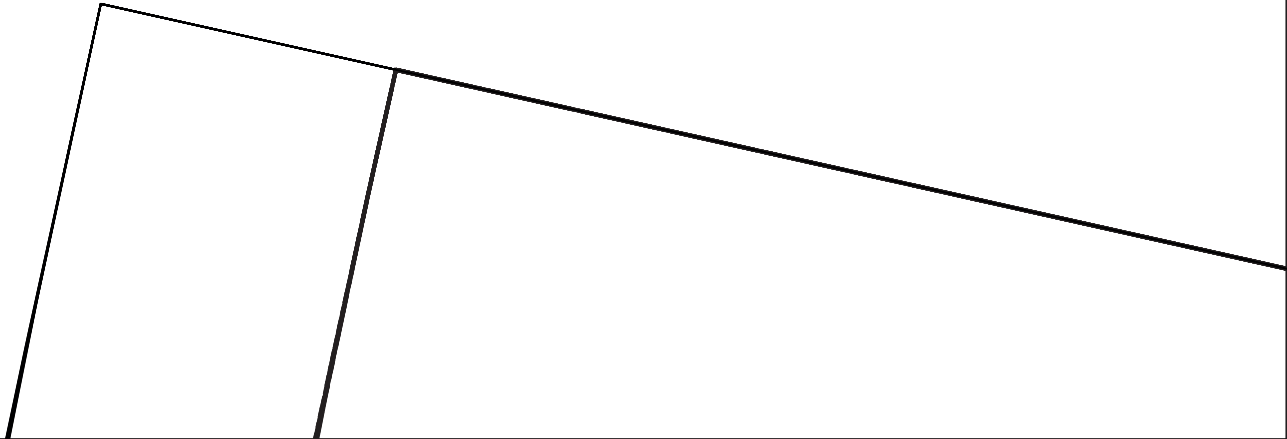



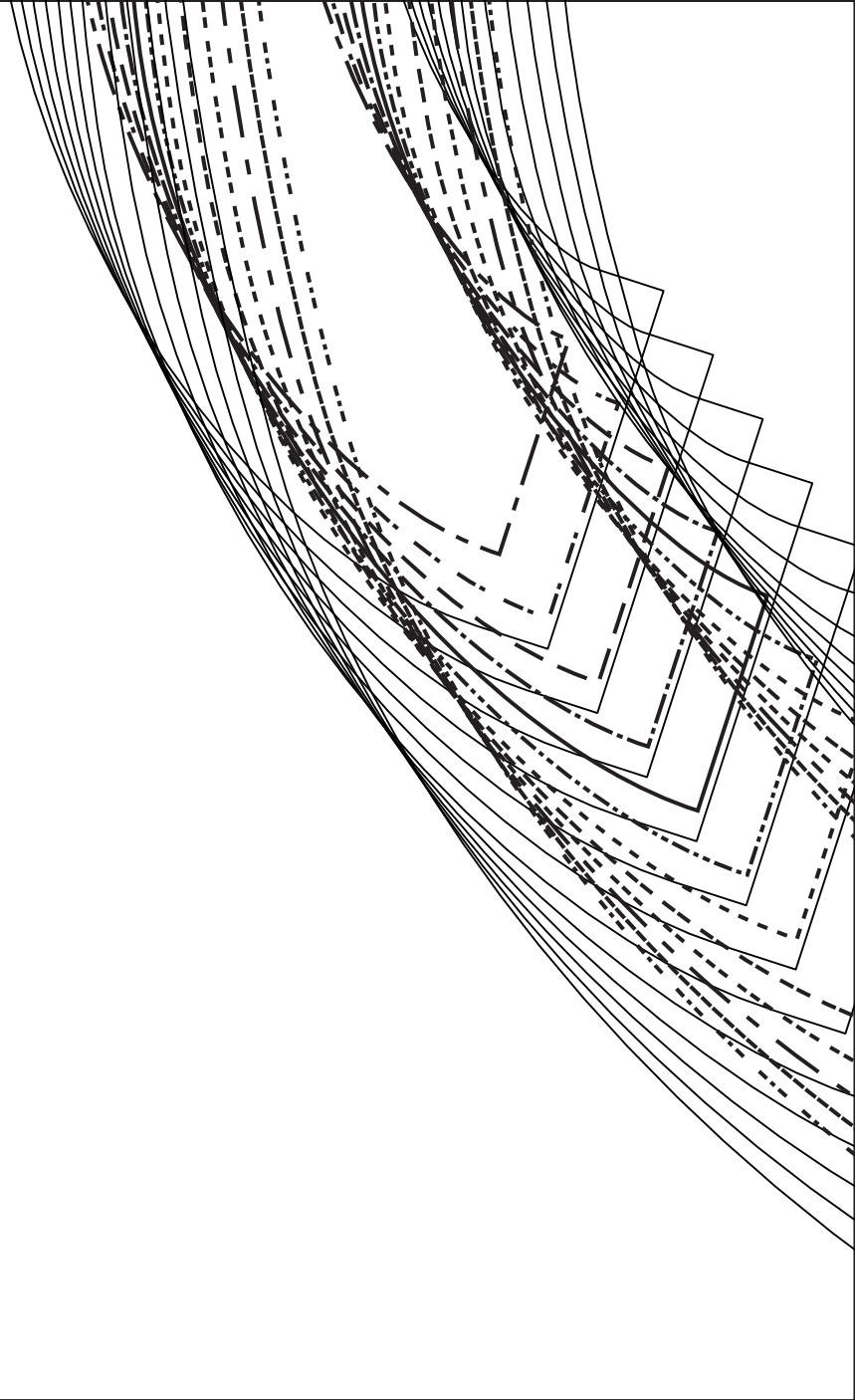

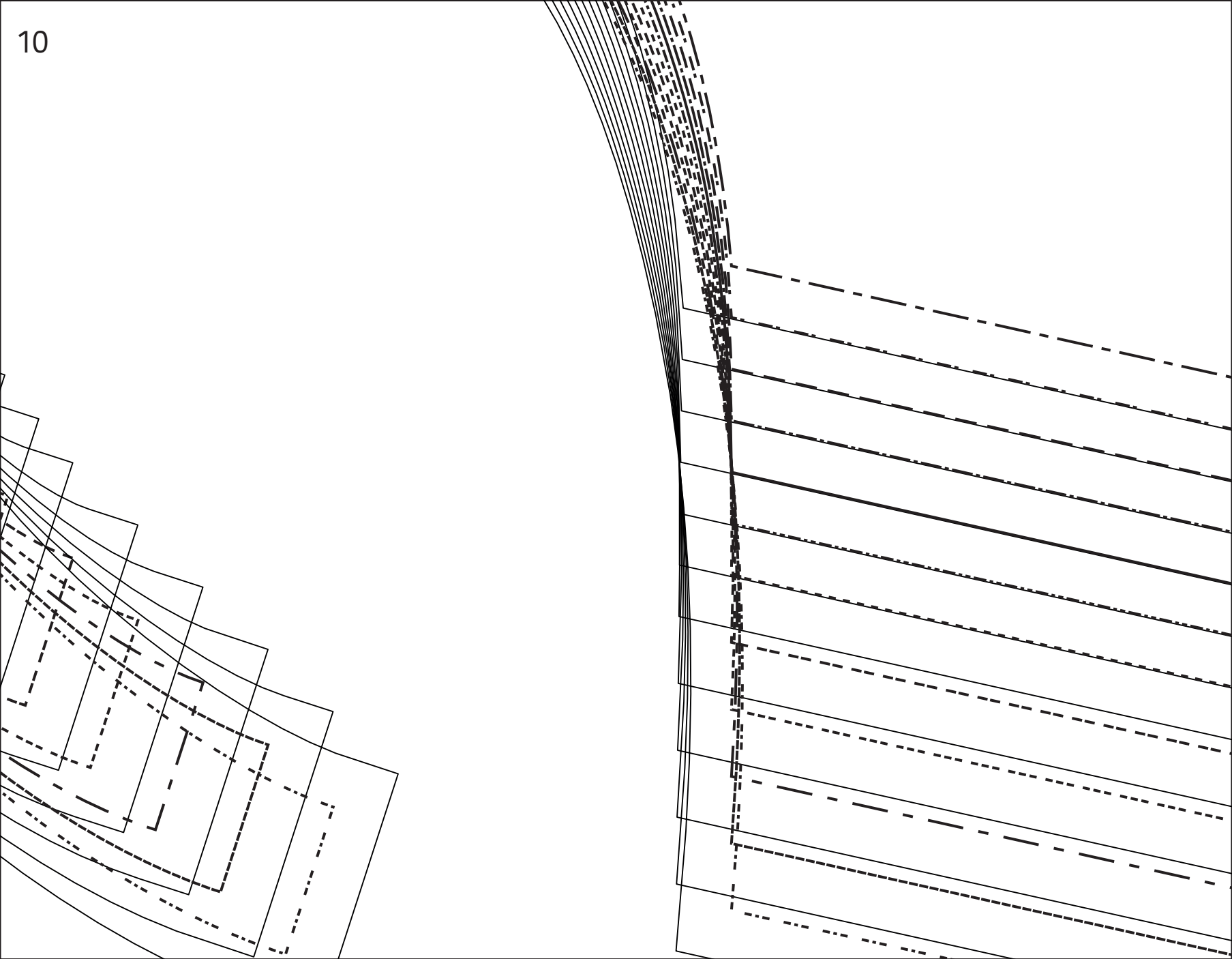

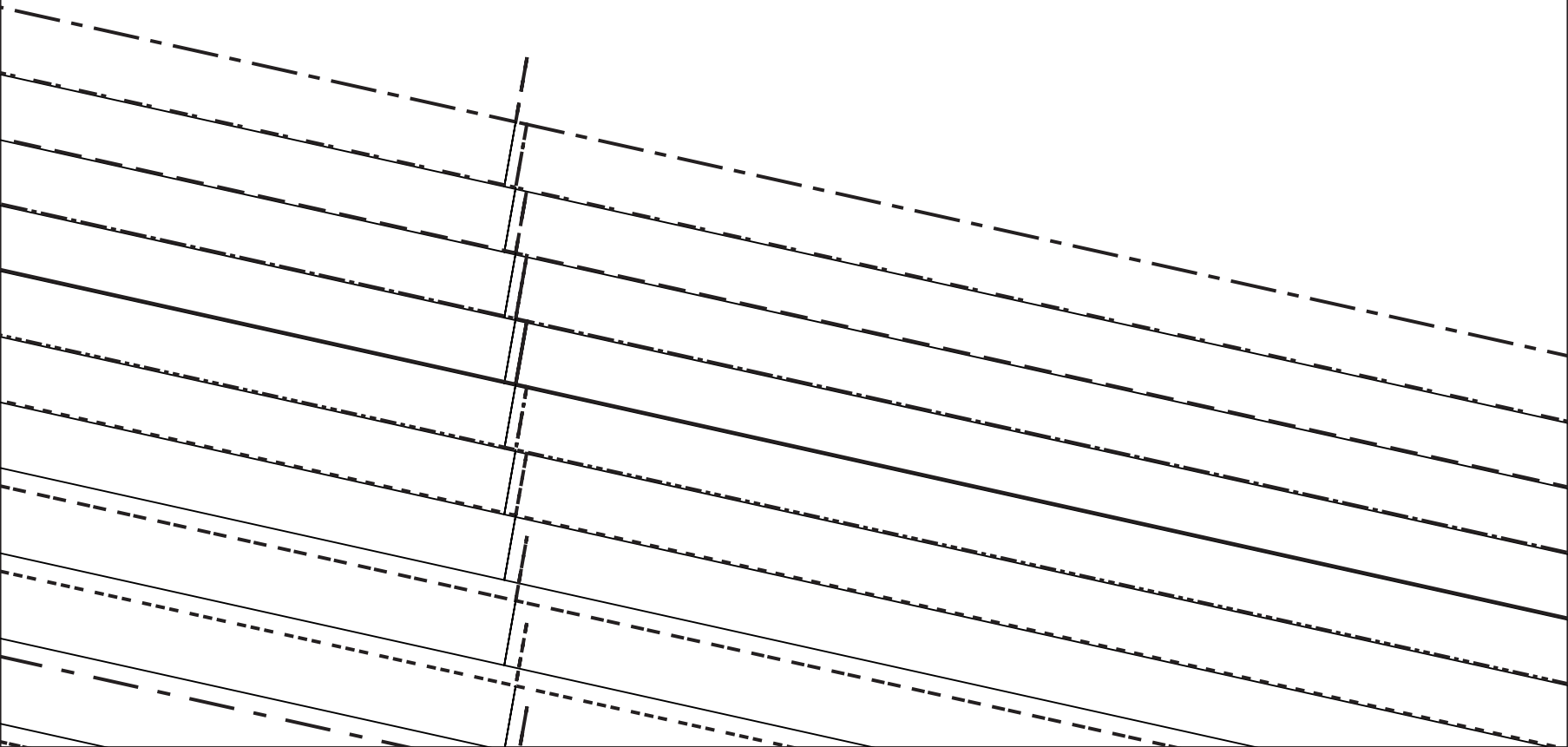

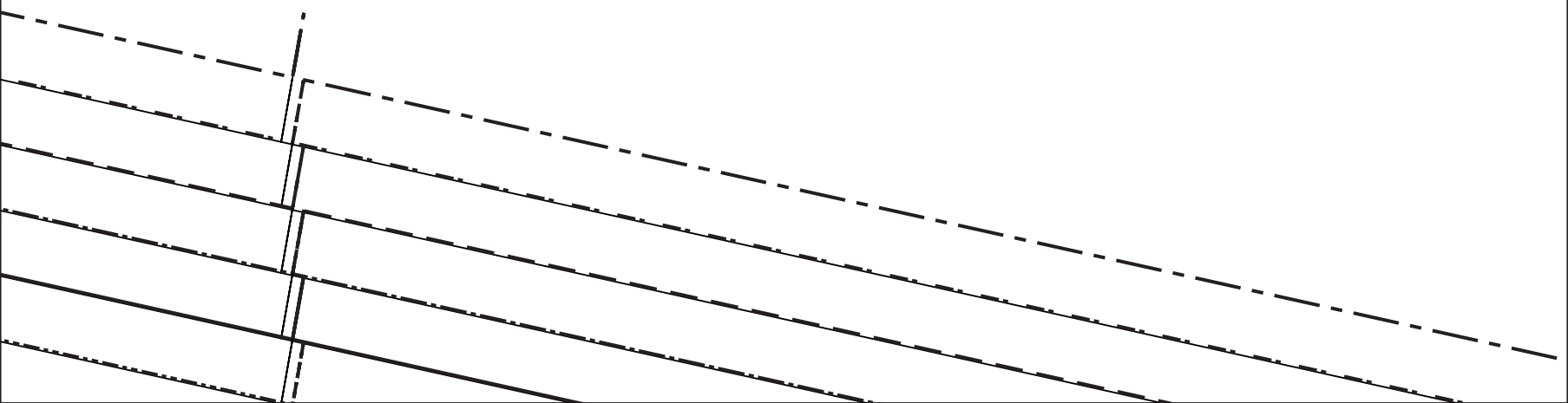



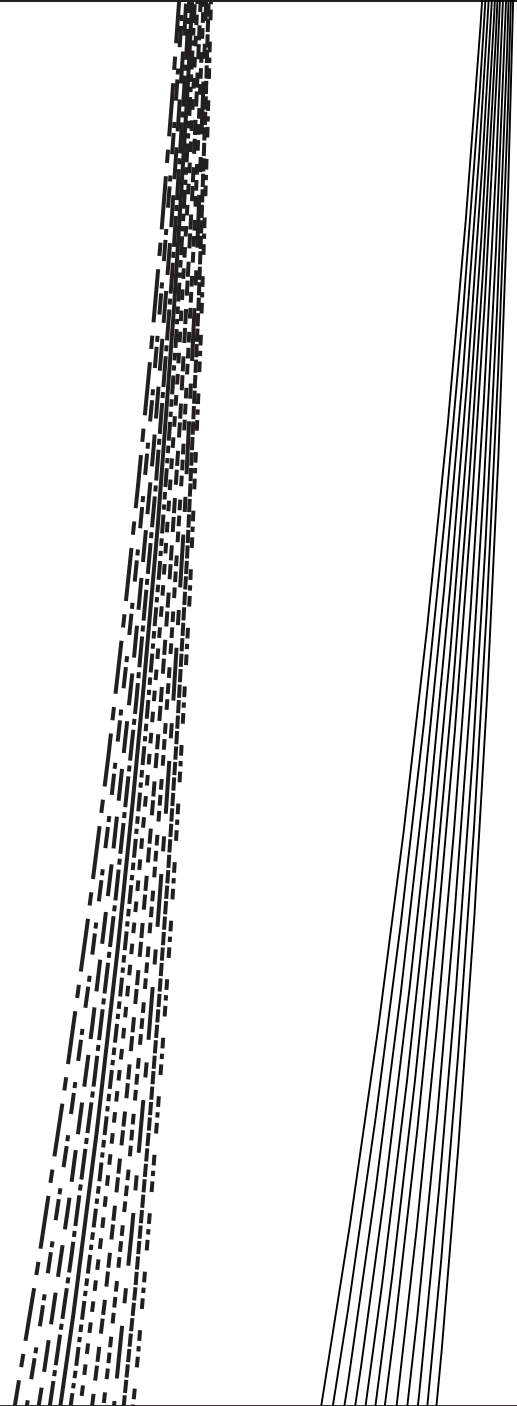

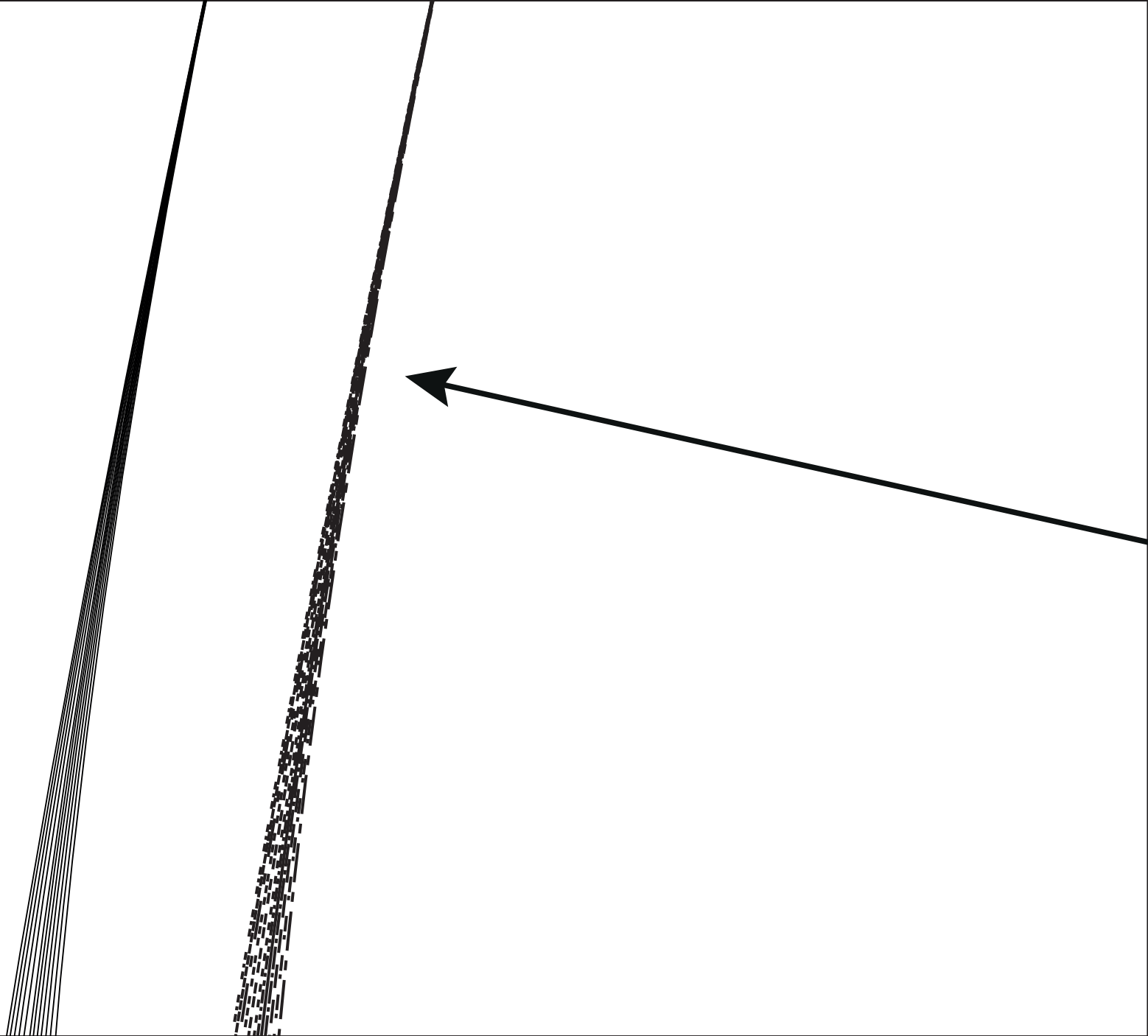

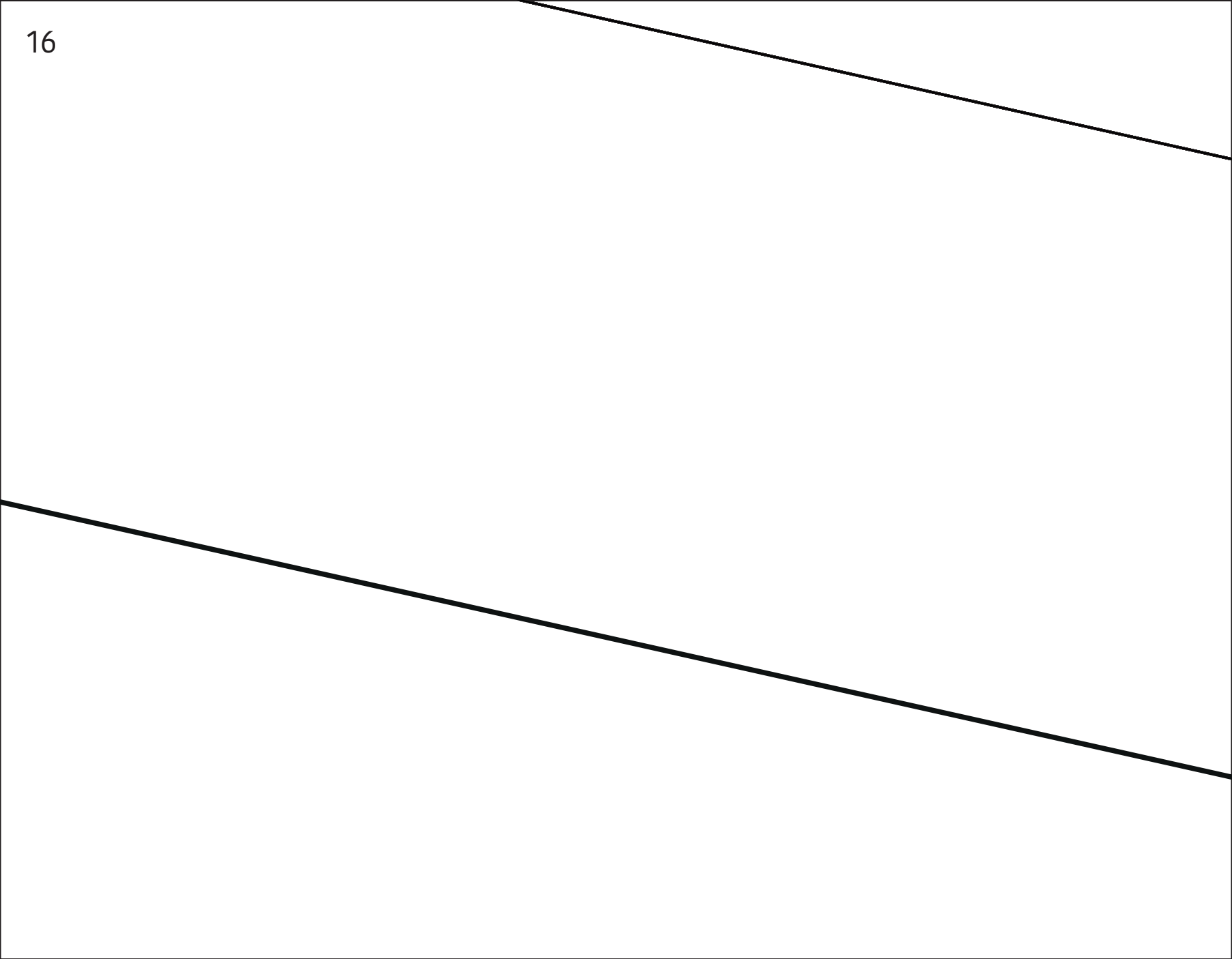



MV/MDV/CF

*Victor*  
LA MAISON

18

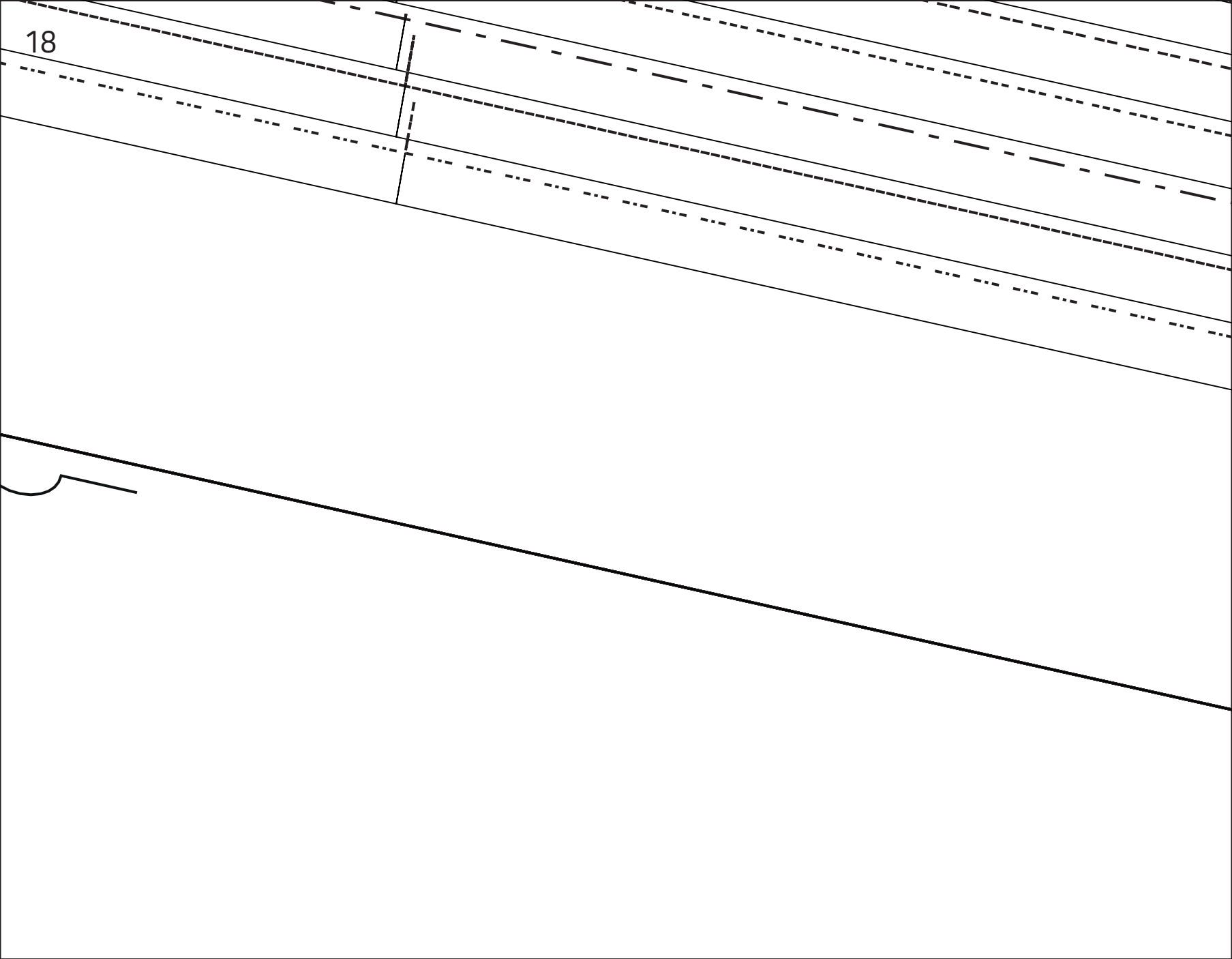

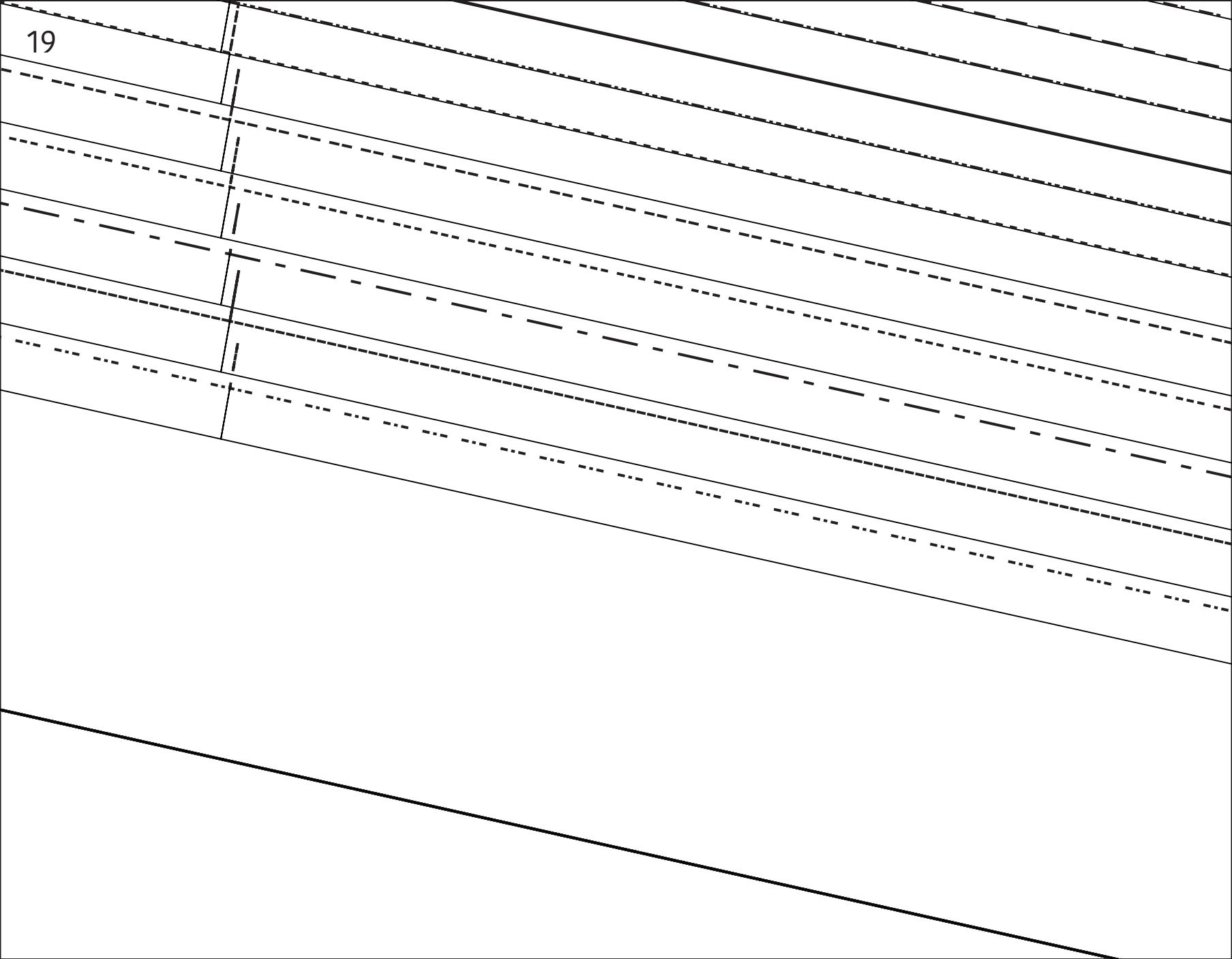

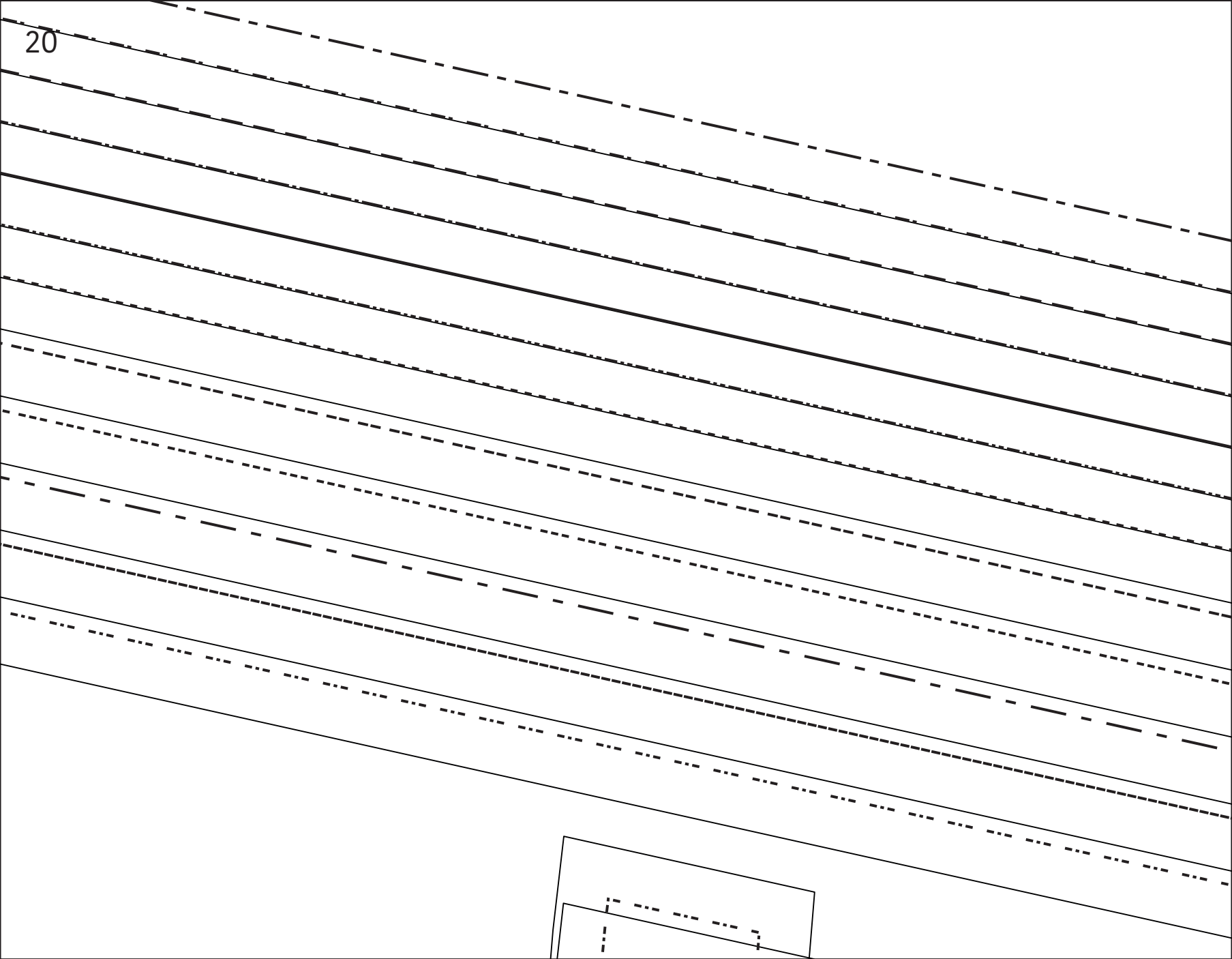

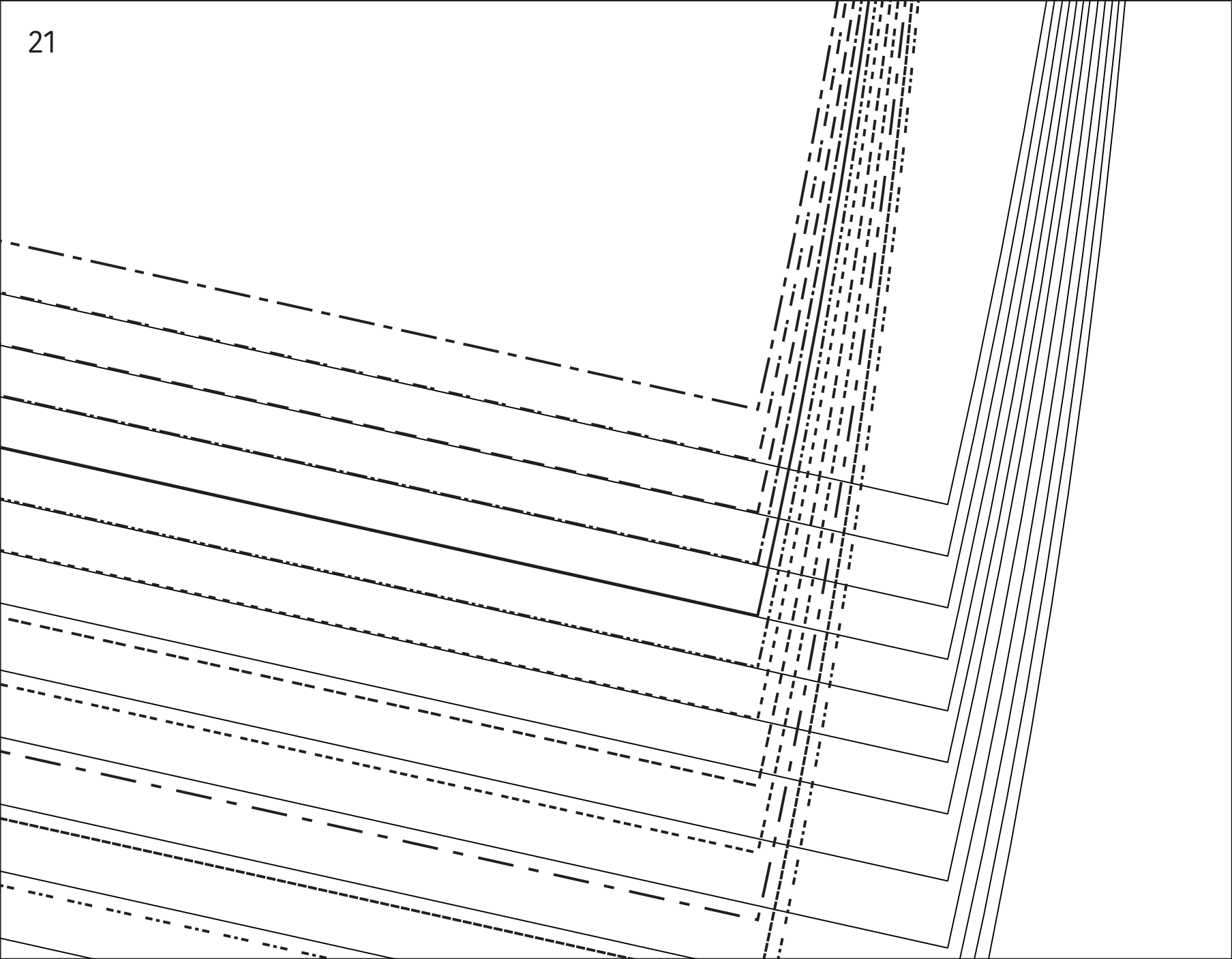

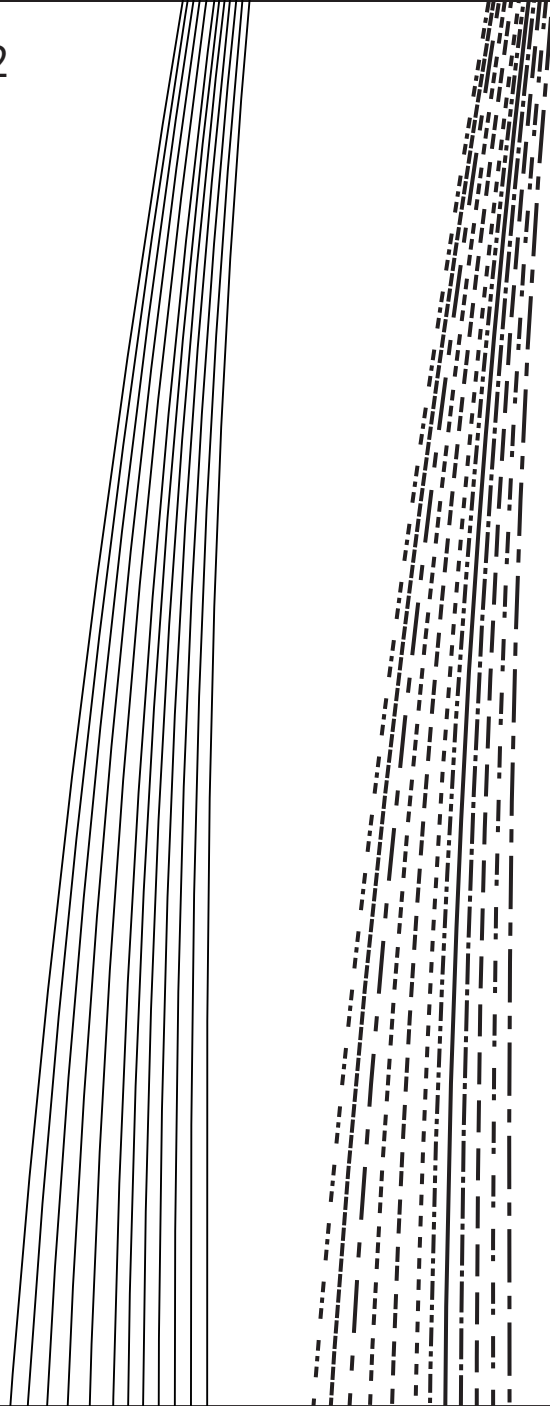



Anastasia - A



25

