

Patroonschema / Schéma du Patron / Pattern Diagram /  
Übersichtsplan zum Zusammenkleben

# Jda

## Trui / Pull / Jumper

### Maten / Tailles / Sizes:

-----	34
-----	36
-----	38
-----	40
-----	42
-----	44
-----	46
-----	48
-----	50
-----	52
-----	54
-----	56

### Patroondelen / Pièces du patron / Pattern pieces:

- A** voorpand / devant / front panel
- B** rugpand / dos / back panel
- C** mouw / manche / sleeve
- D** kraag / col / collar
- E** zoomboord / bord ourlet / hem trim
- F** polsboord / bord manchette / cuff

1	2	3	4	5	6
7	8	9	10	11	12
13	14	15	16	17	18
19	20	21	22	23	24
25	26	27	28	29	

### Controlevierkant / Carré de controle / Test square / Kontrollquadrat

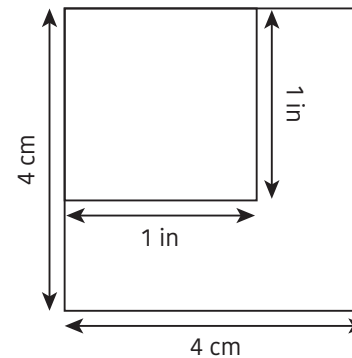

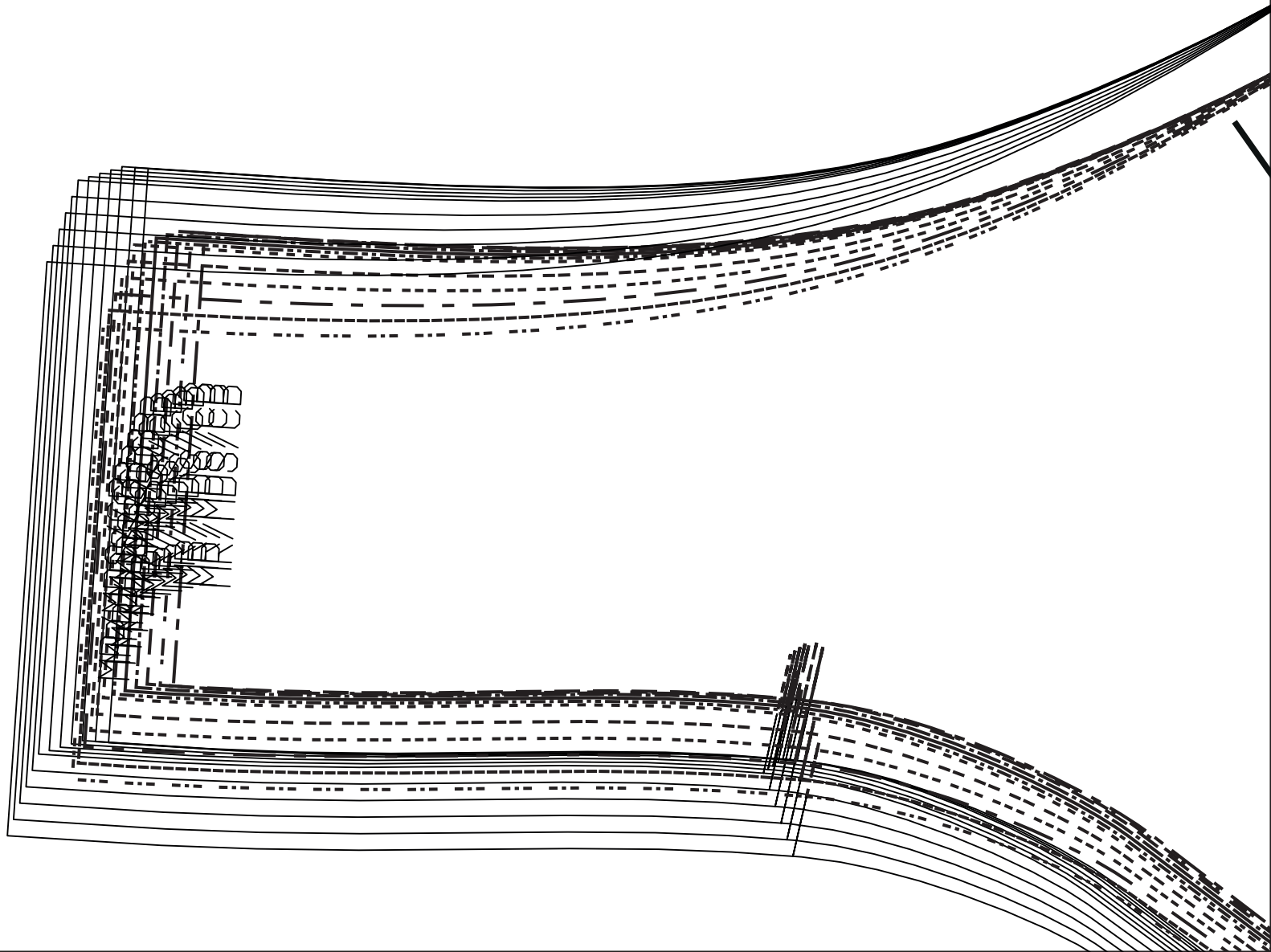

3



IDA -

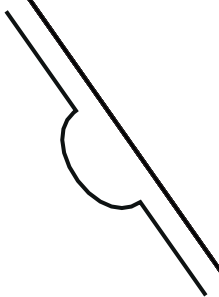

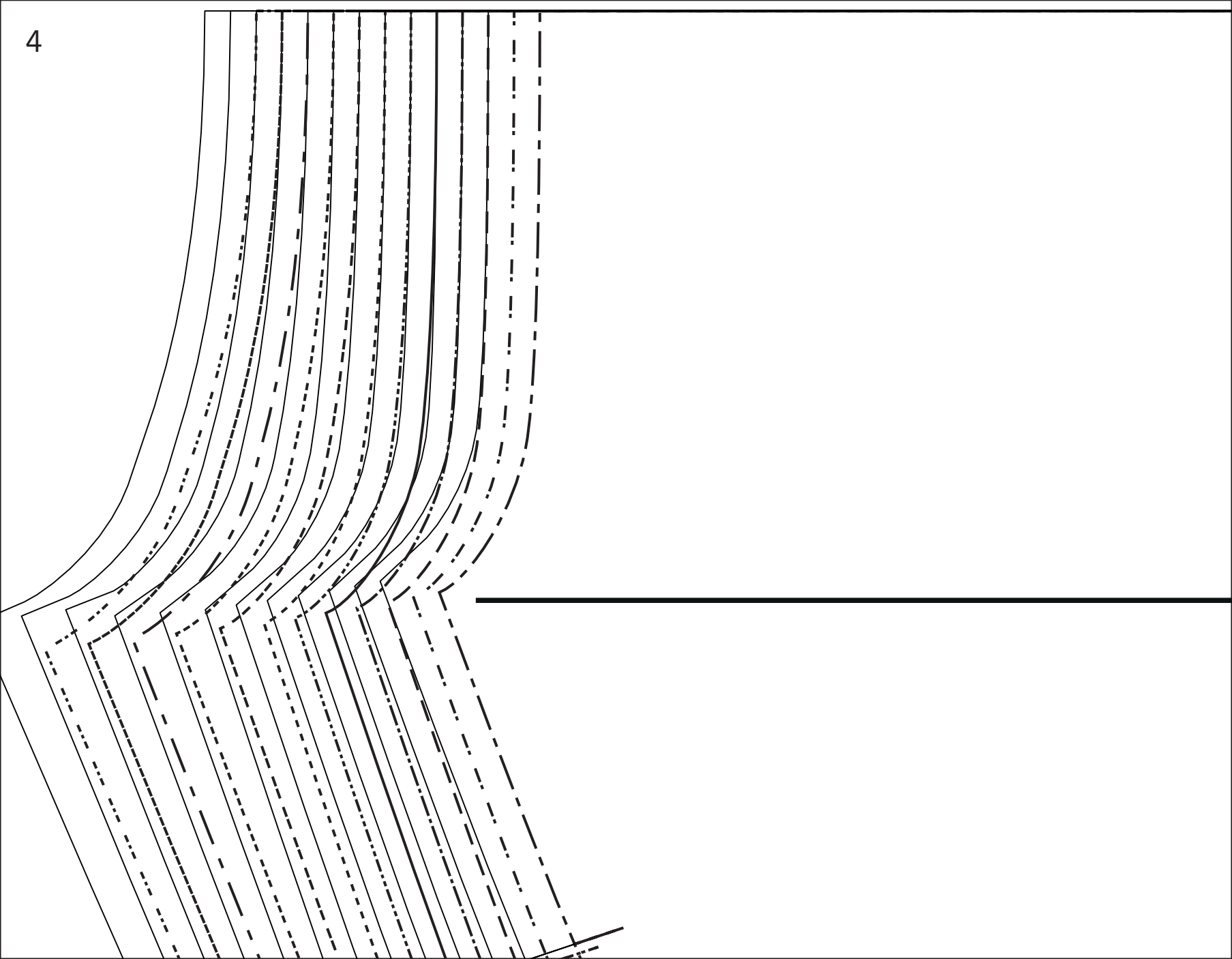



# IDA - B

*Victor* LA MAISON



--	--	--	--	--	--

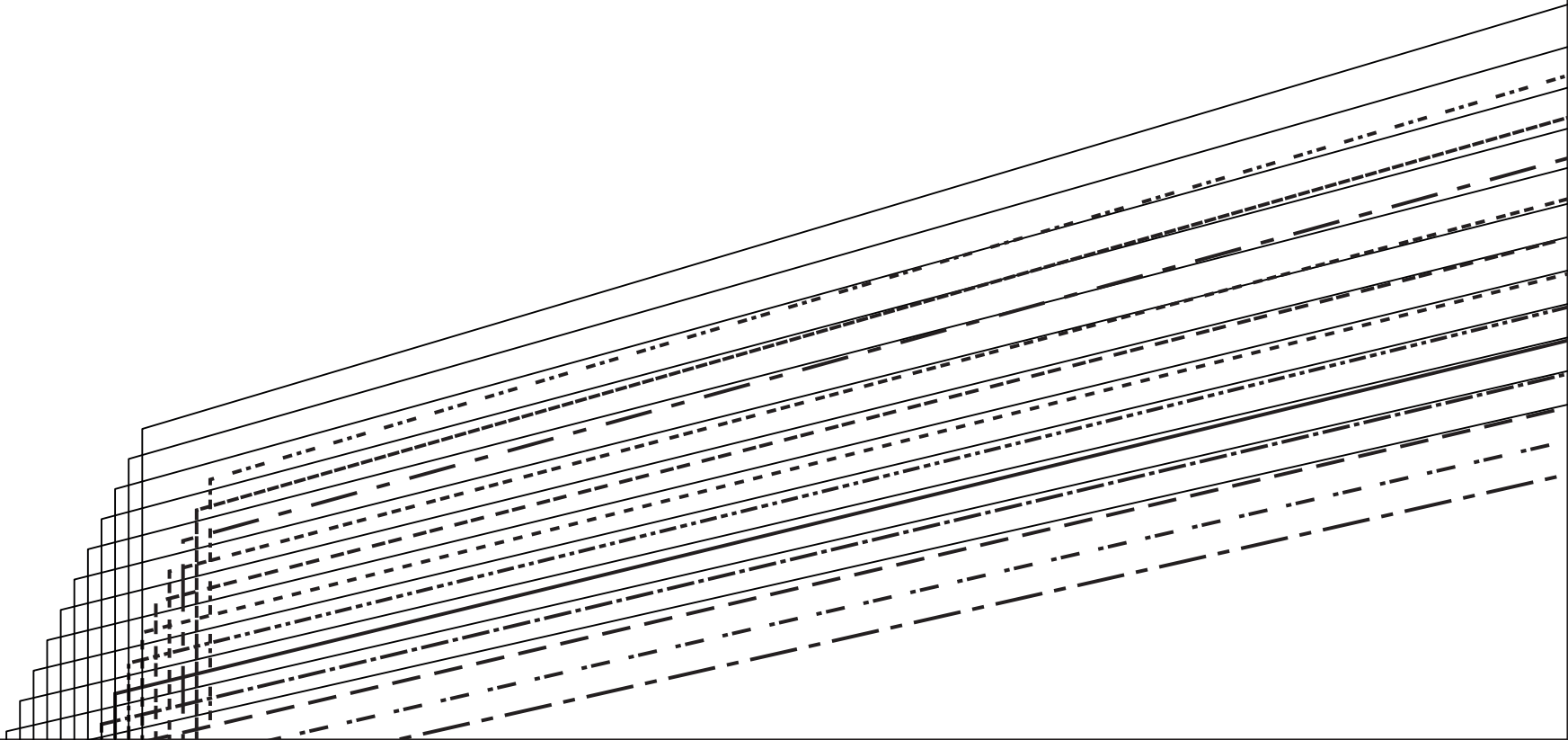

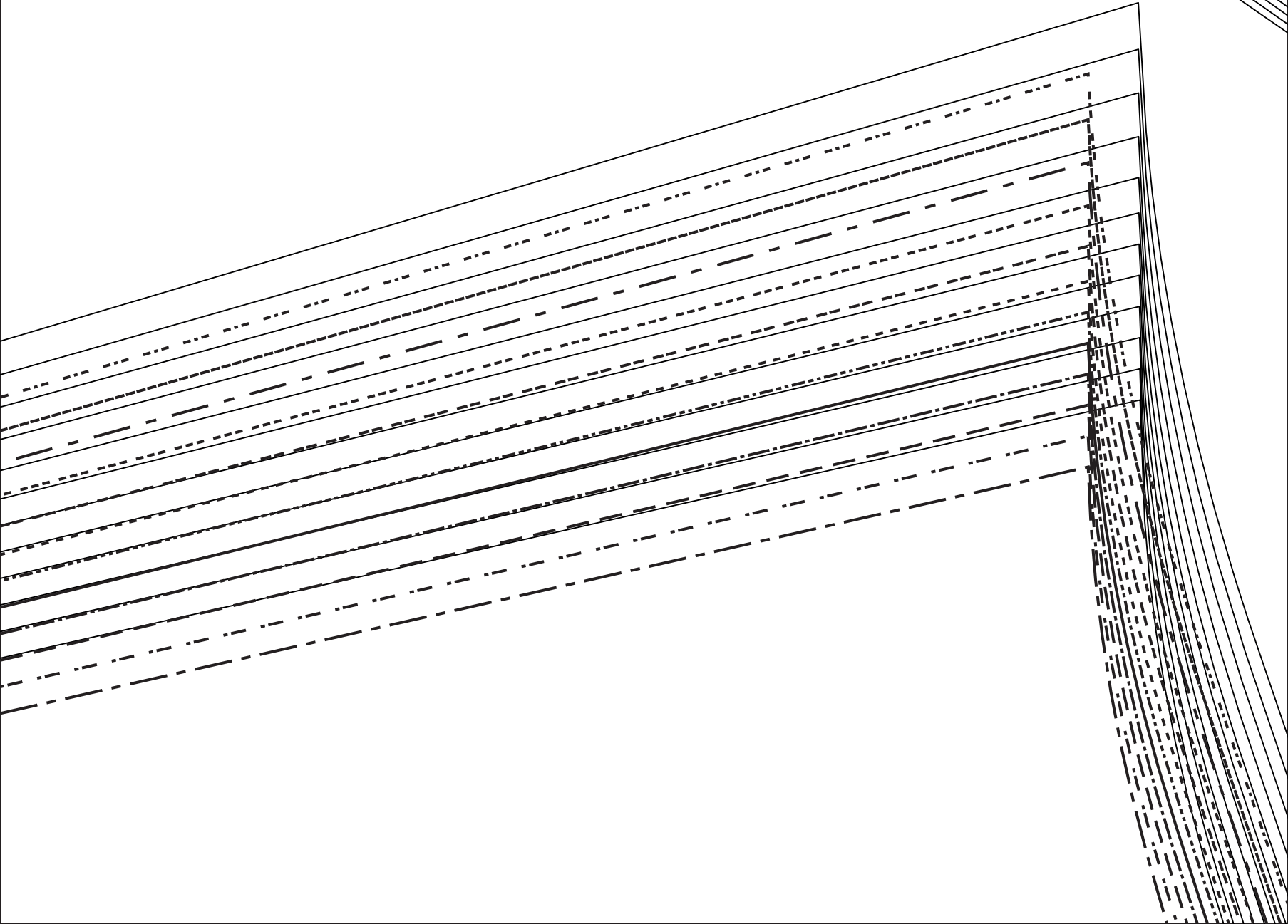



**D**  
LA MAISON  
*victor*

MV/MDV/CF

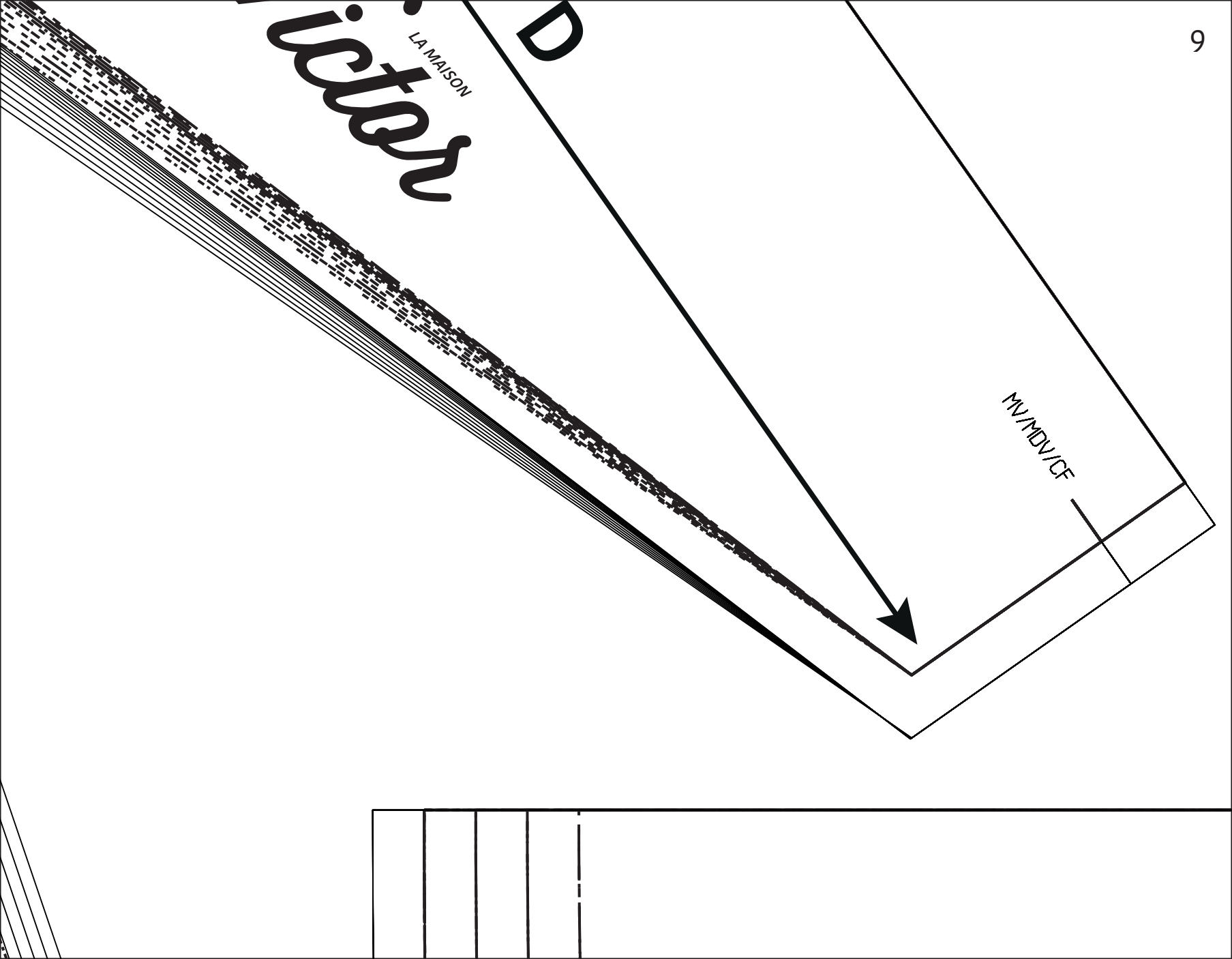

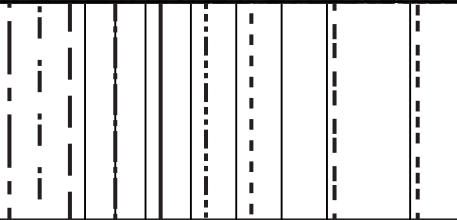
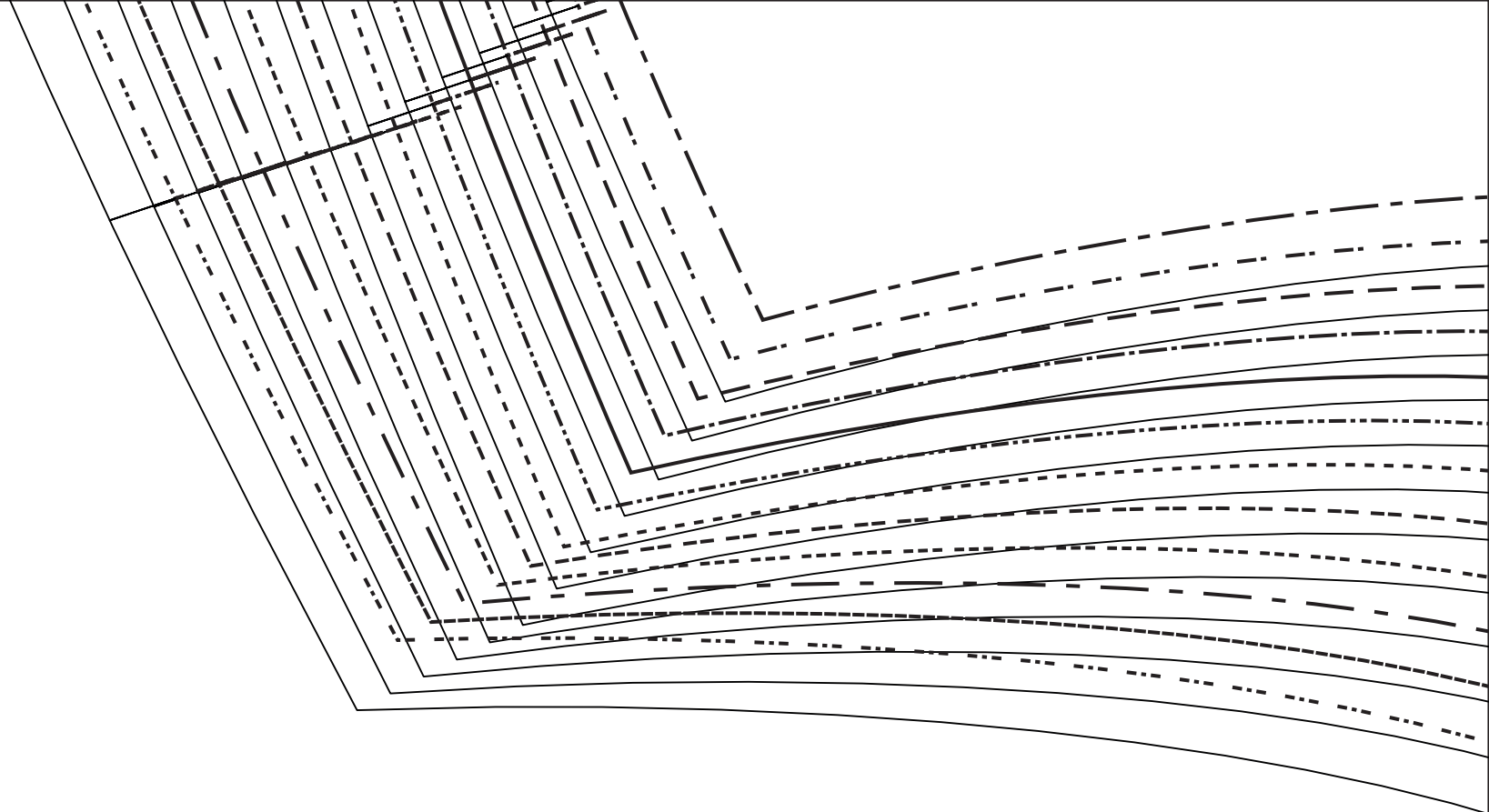

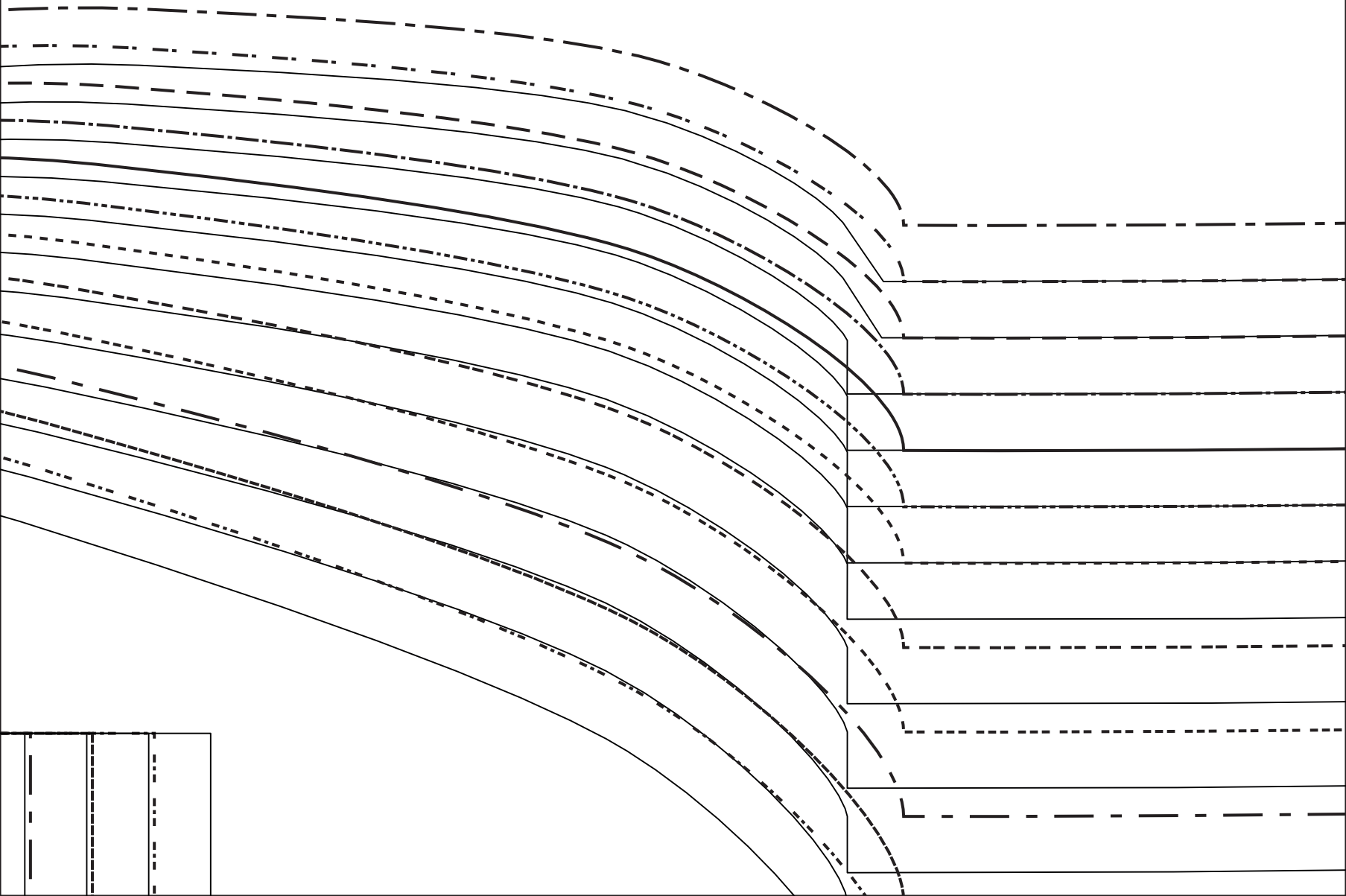

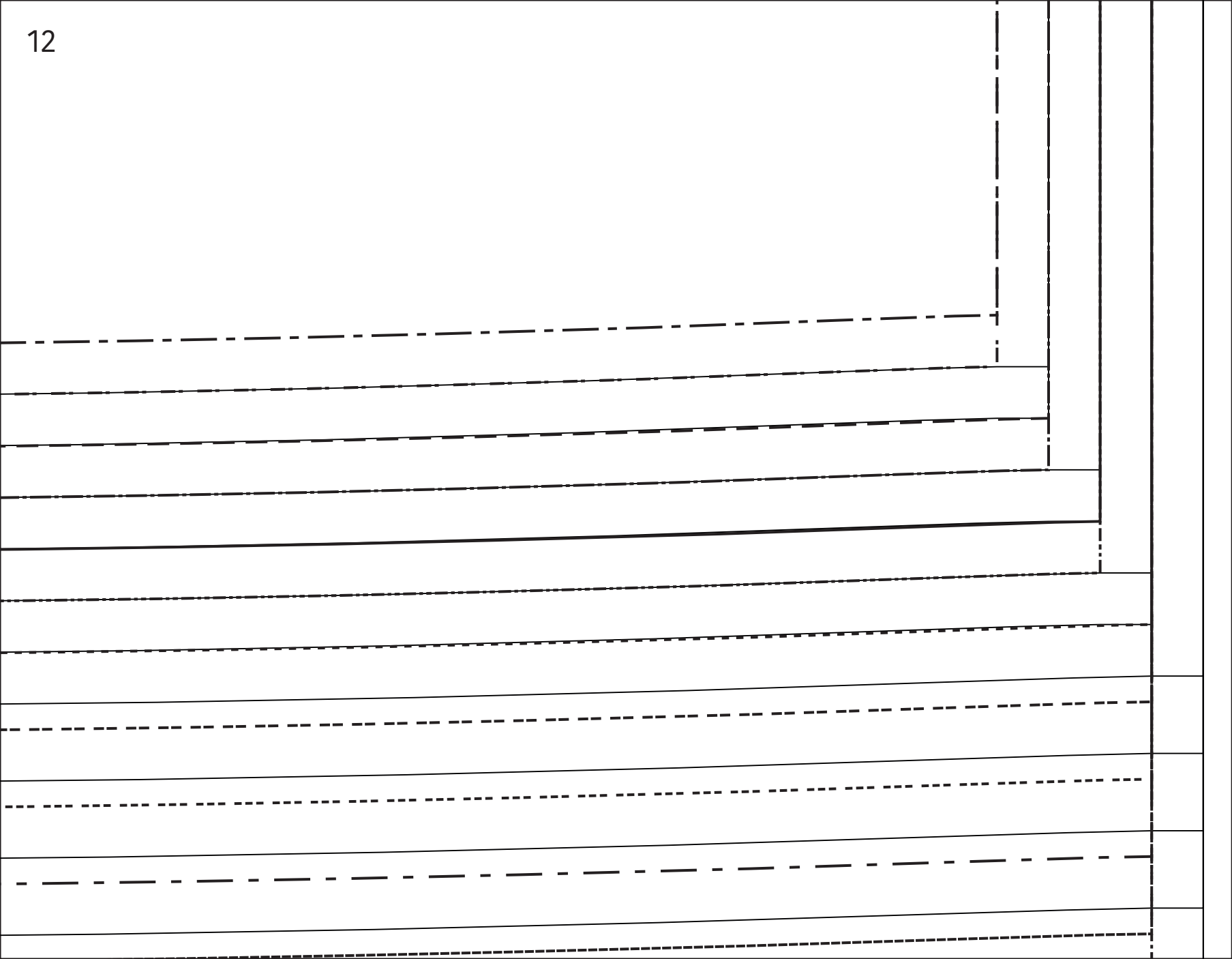

*fox*  
LA MAISON

- C

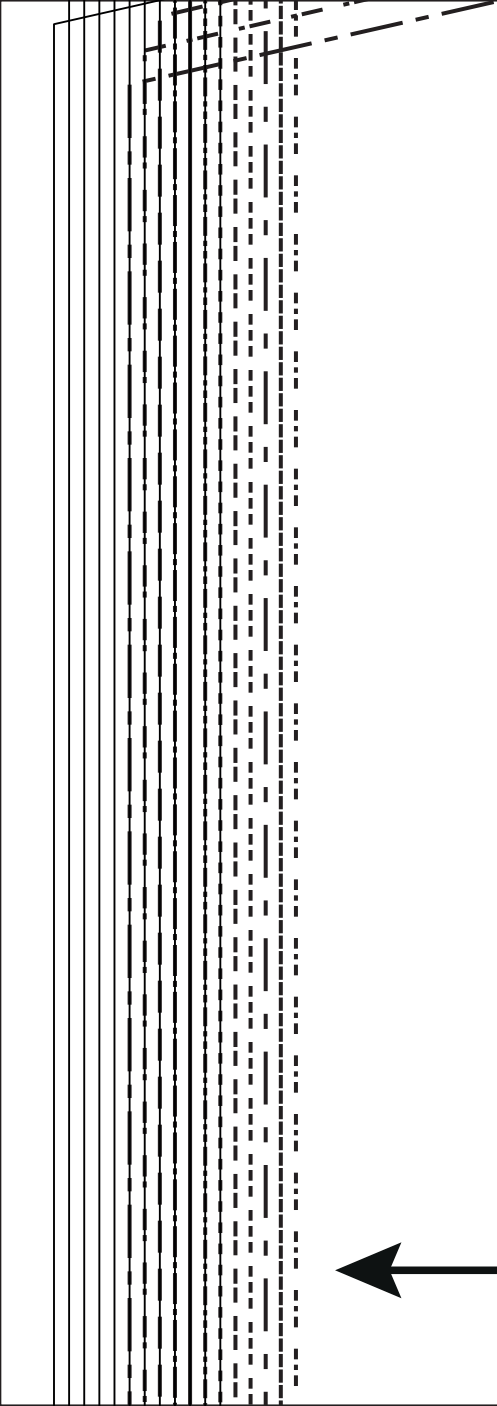

*Via*

**IDA**



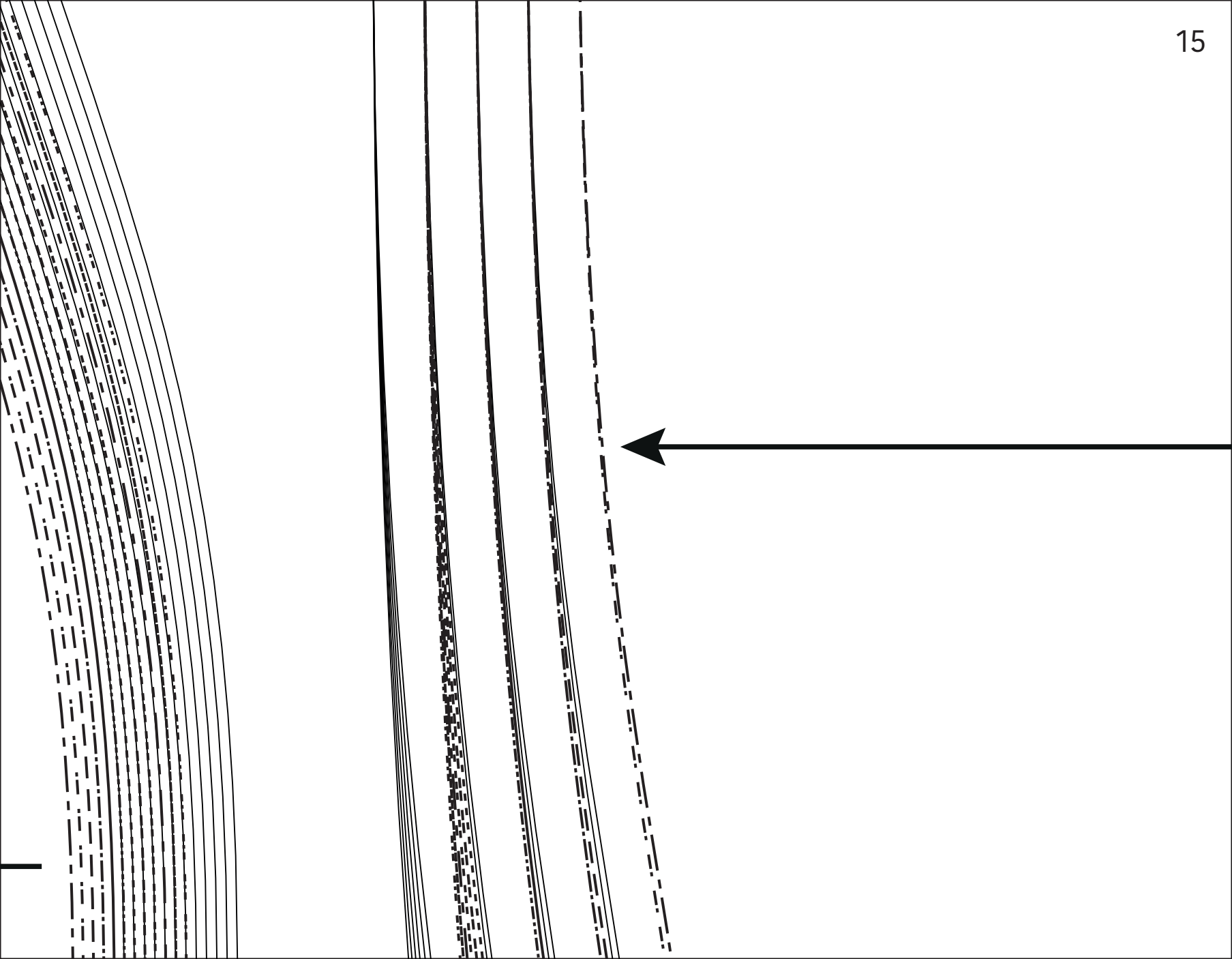

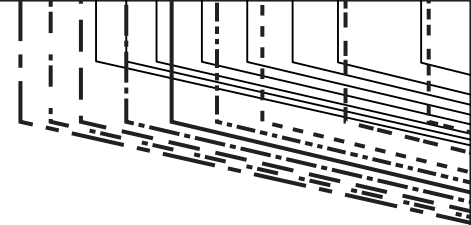

*Victor*  
LA MAISON

IDA - A



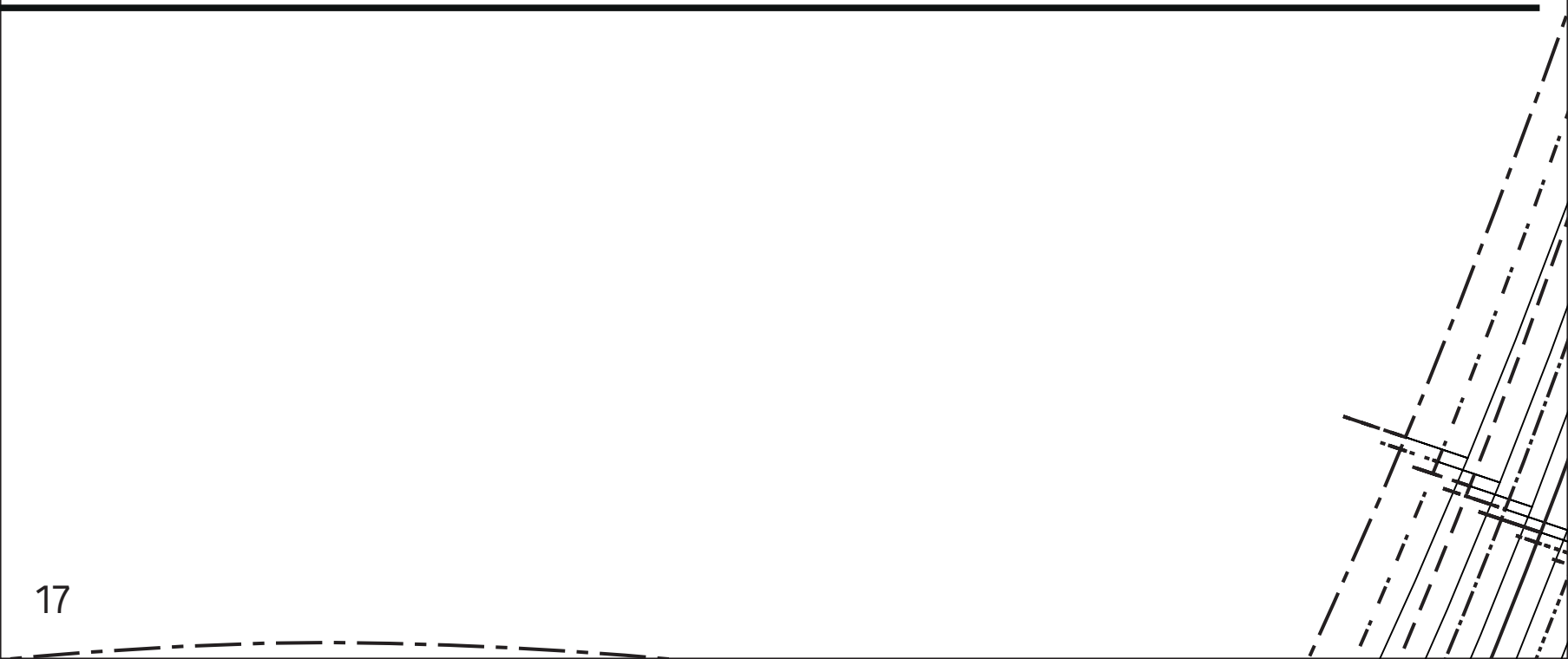
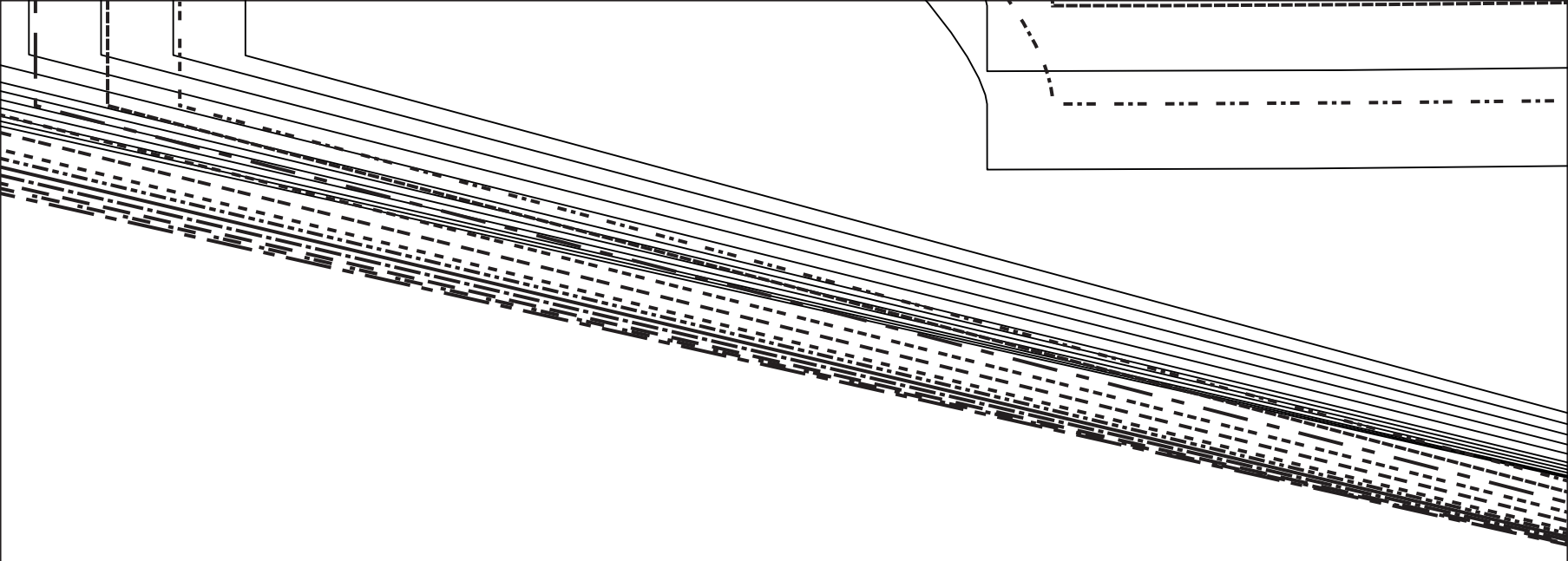

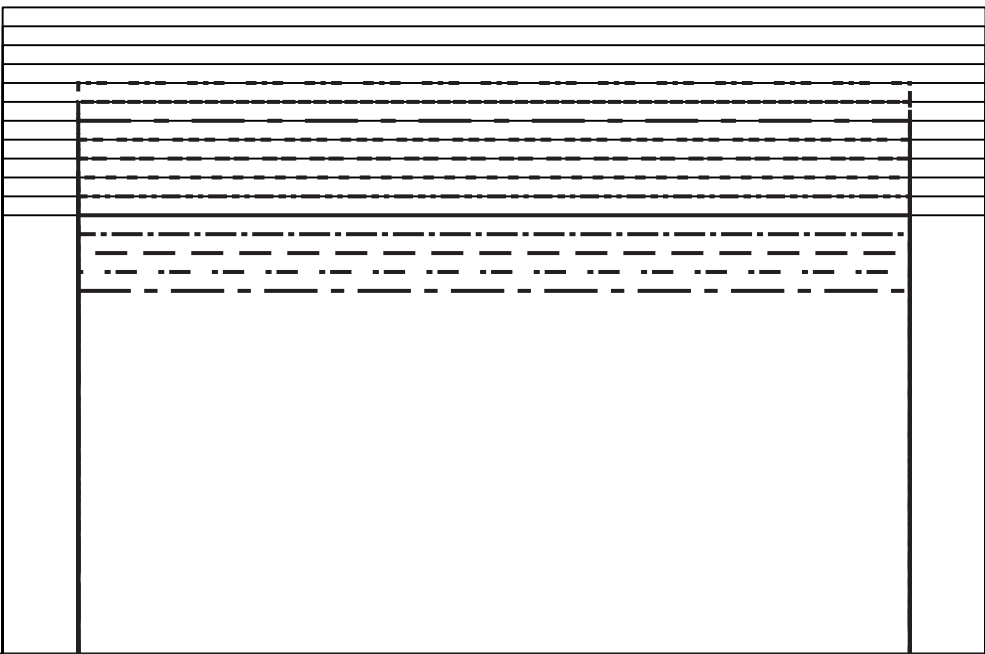
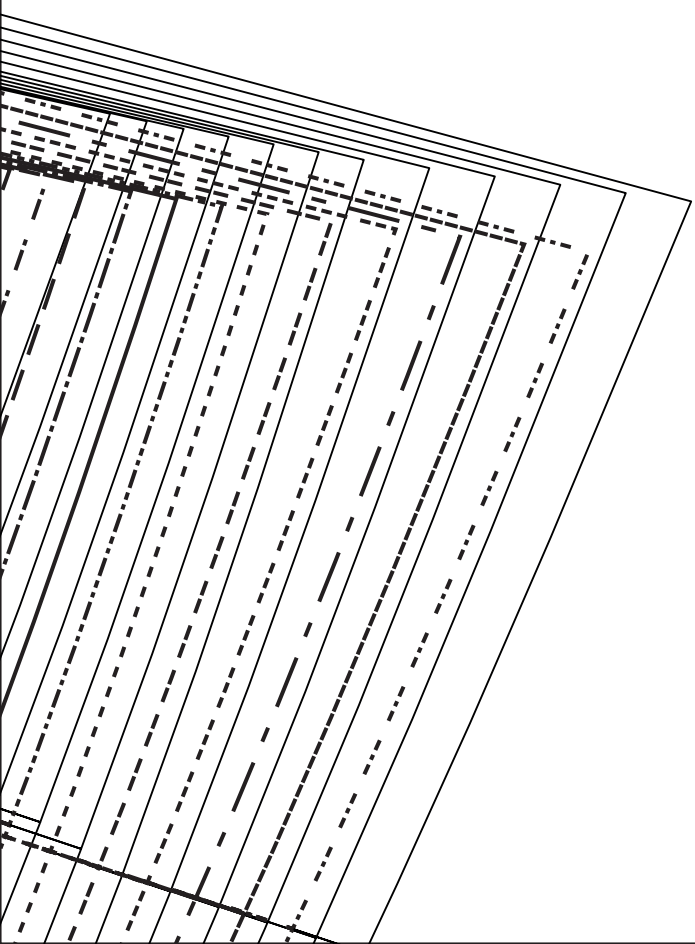
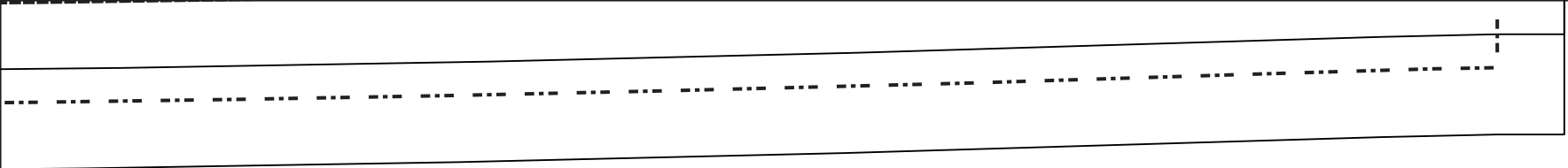

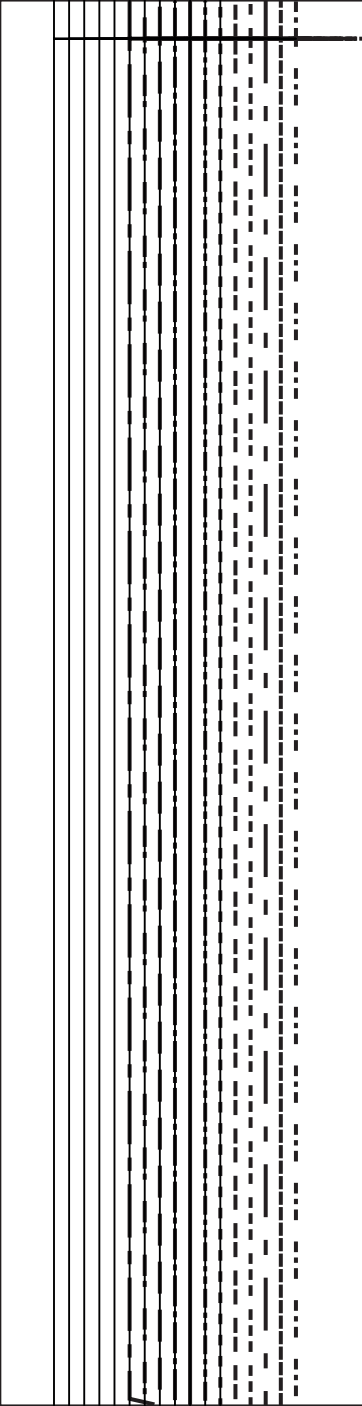



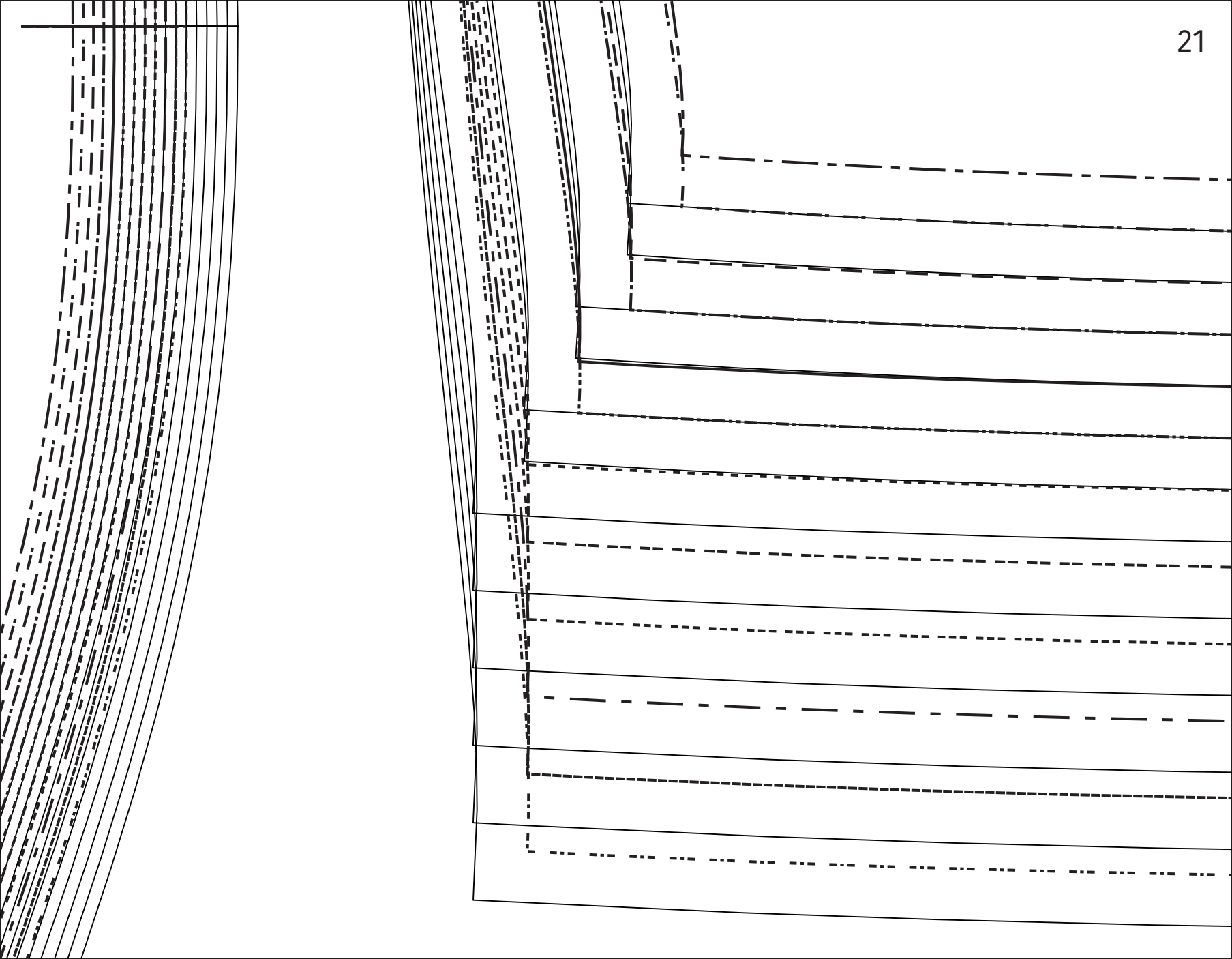

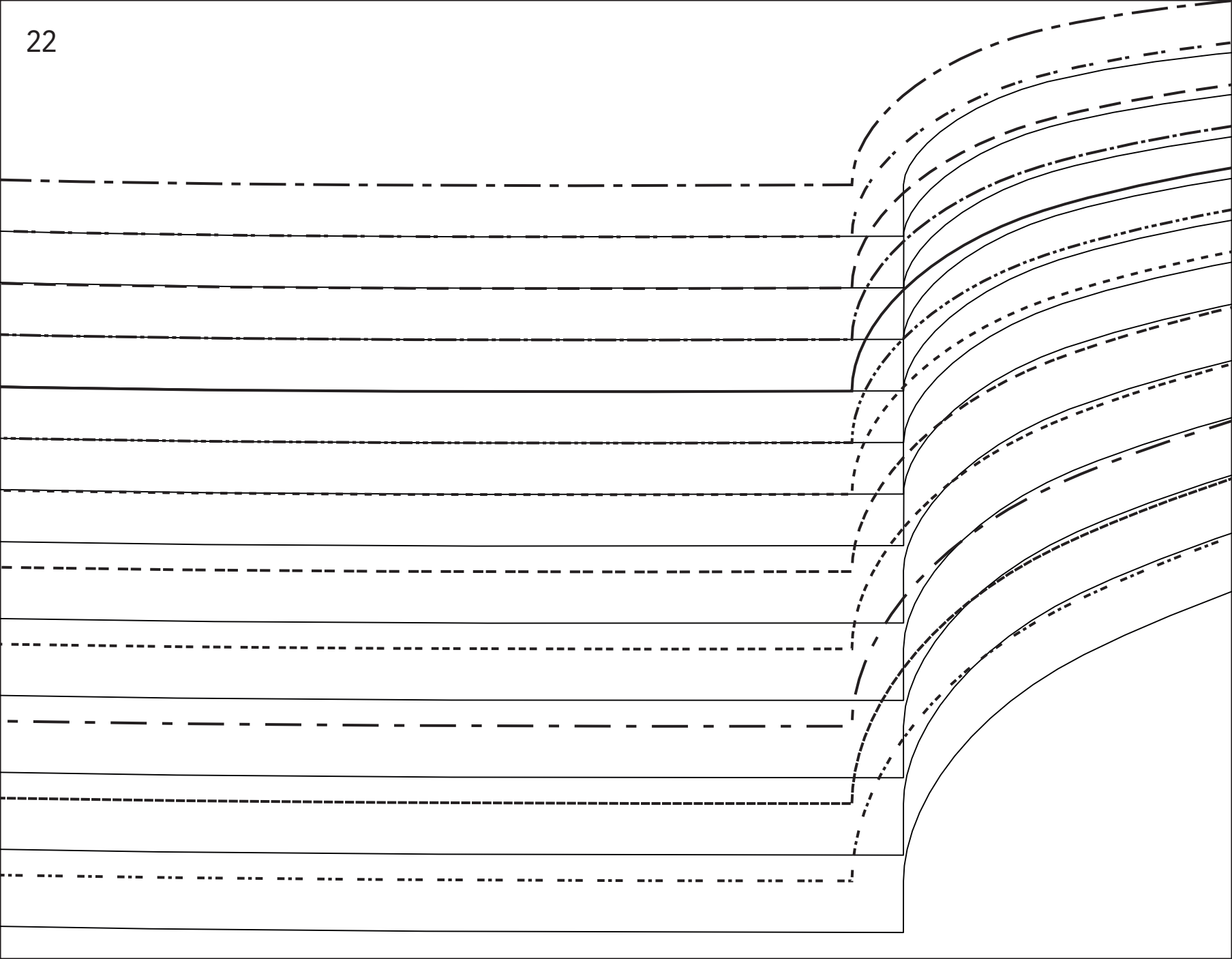

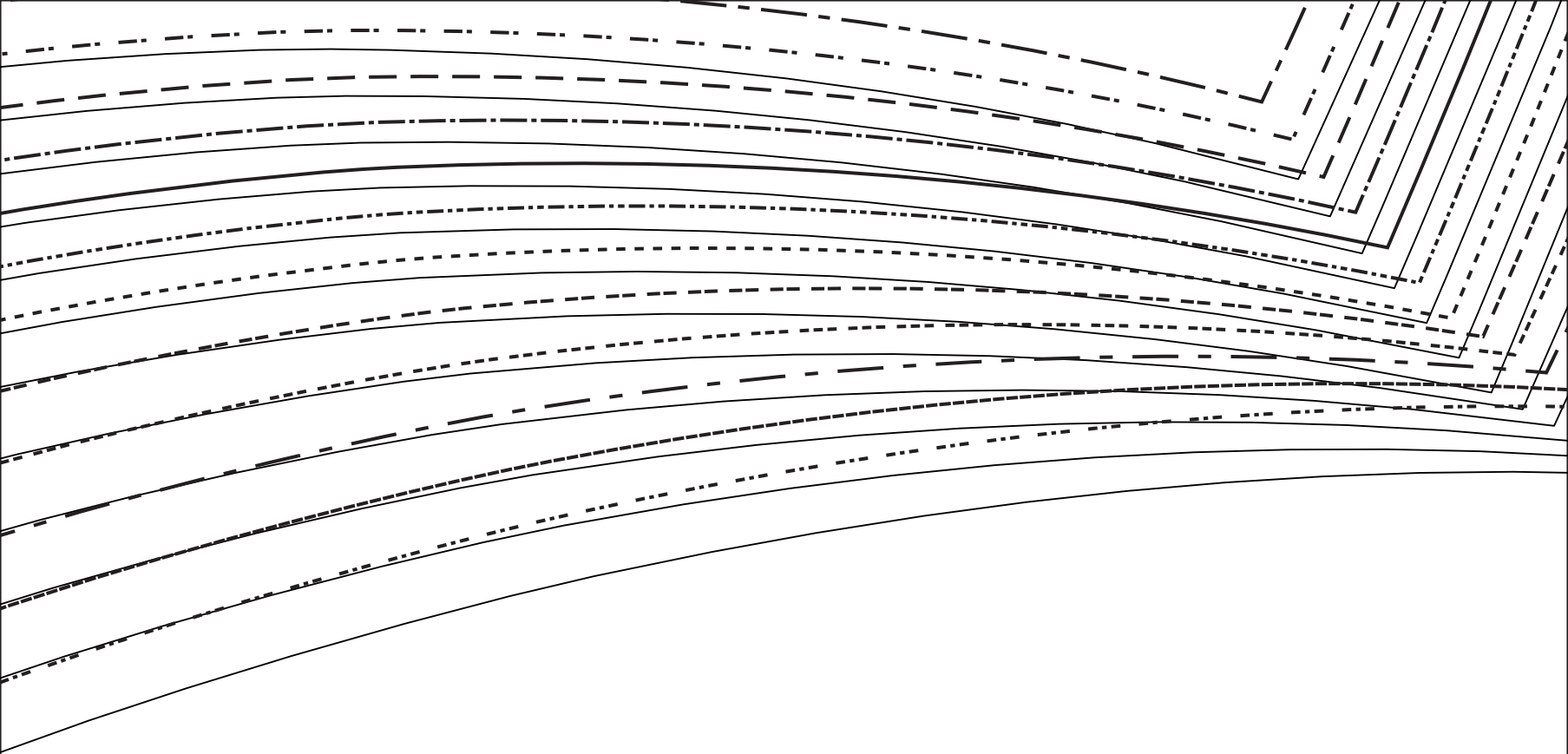

IDA - F



*Victor*  
LA MAISON

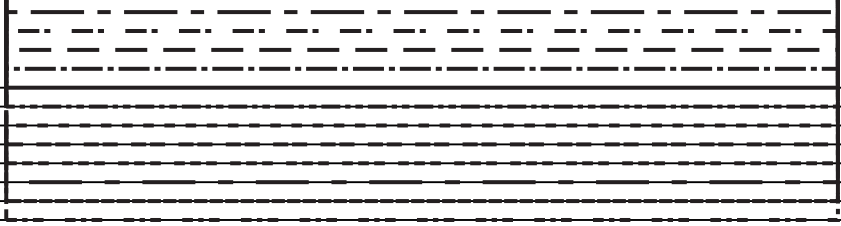



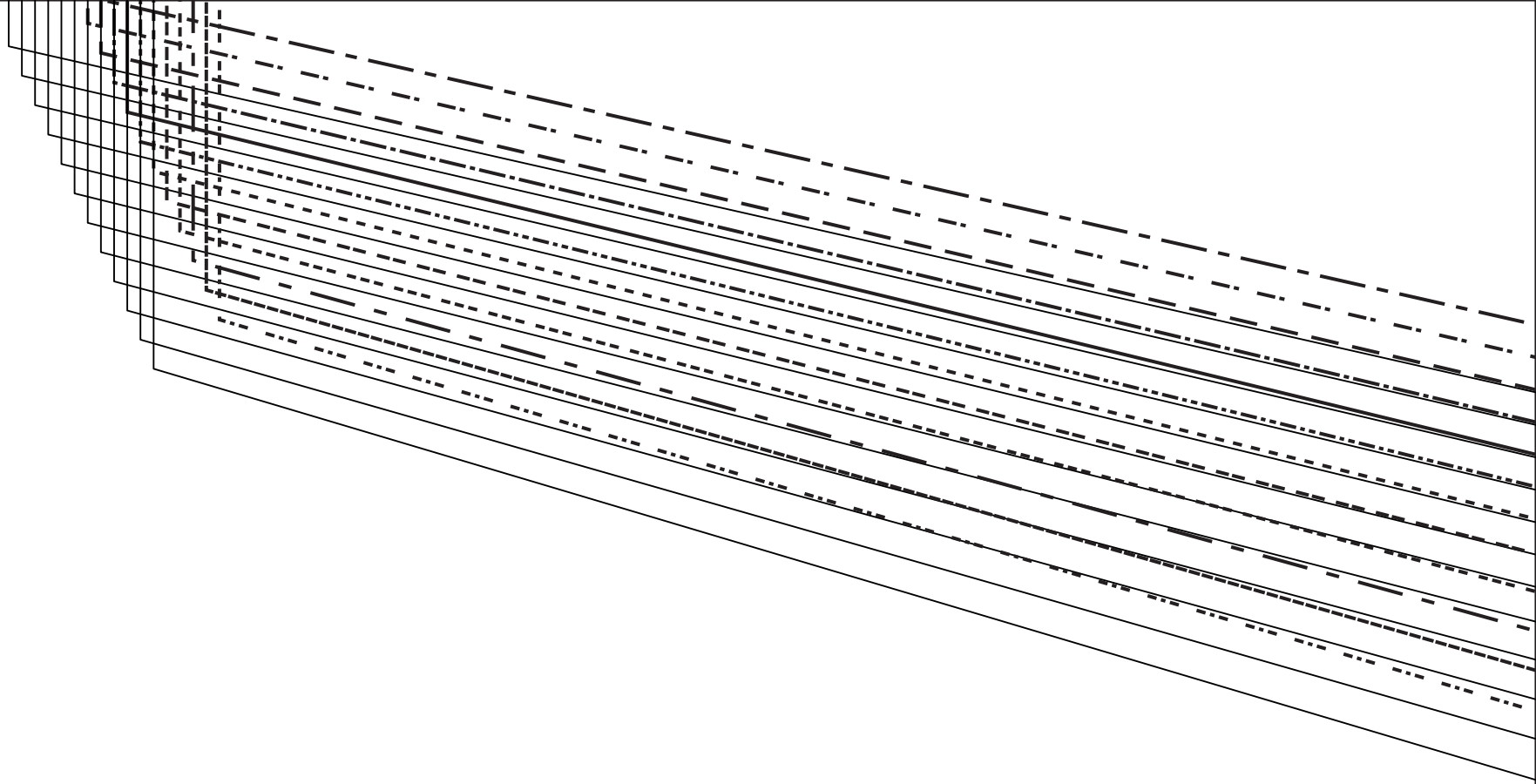

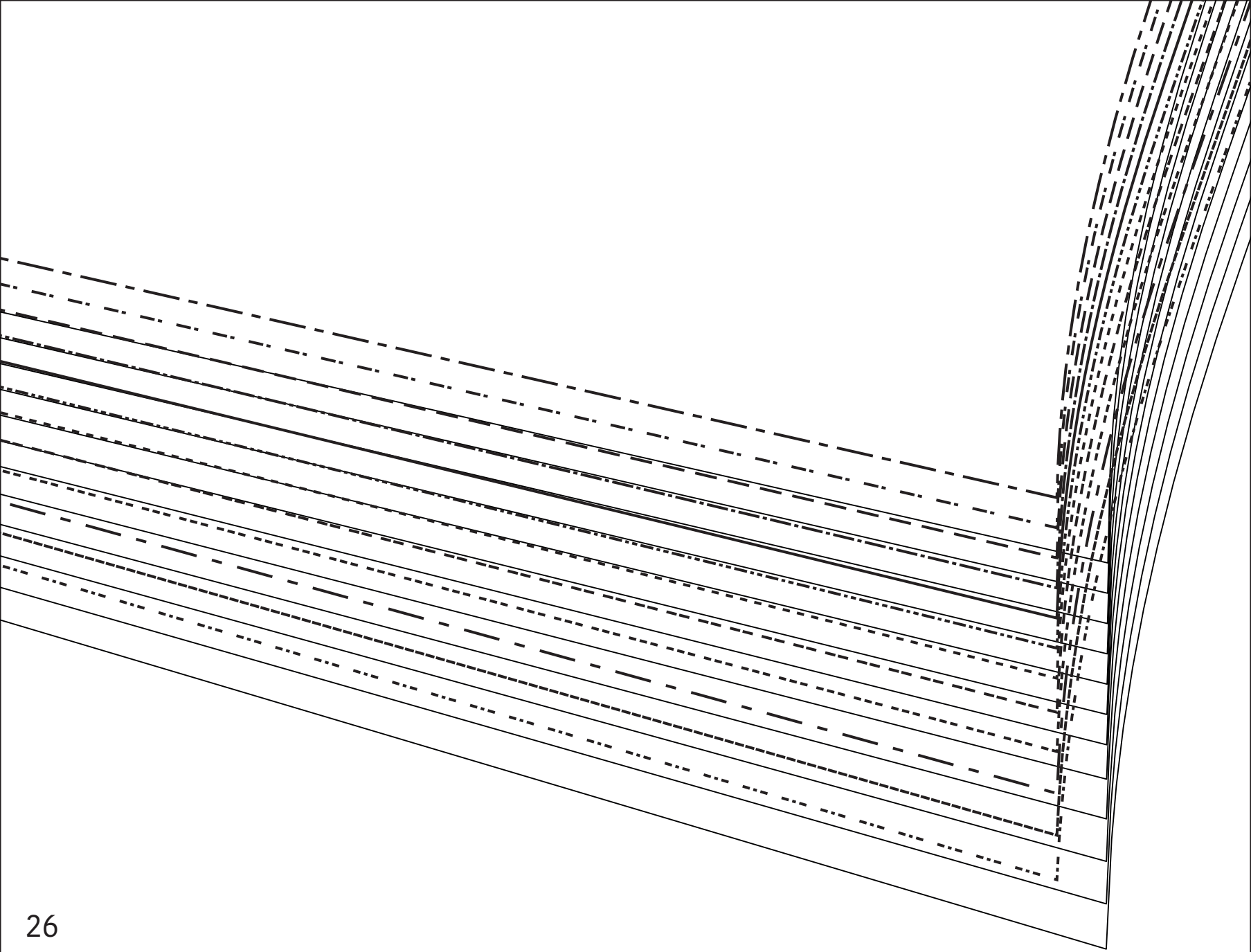

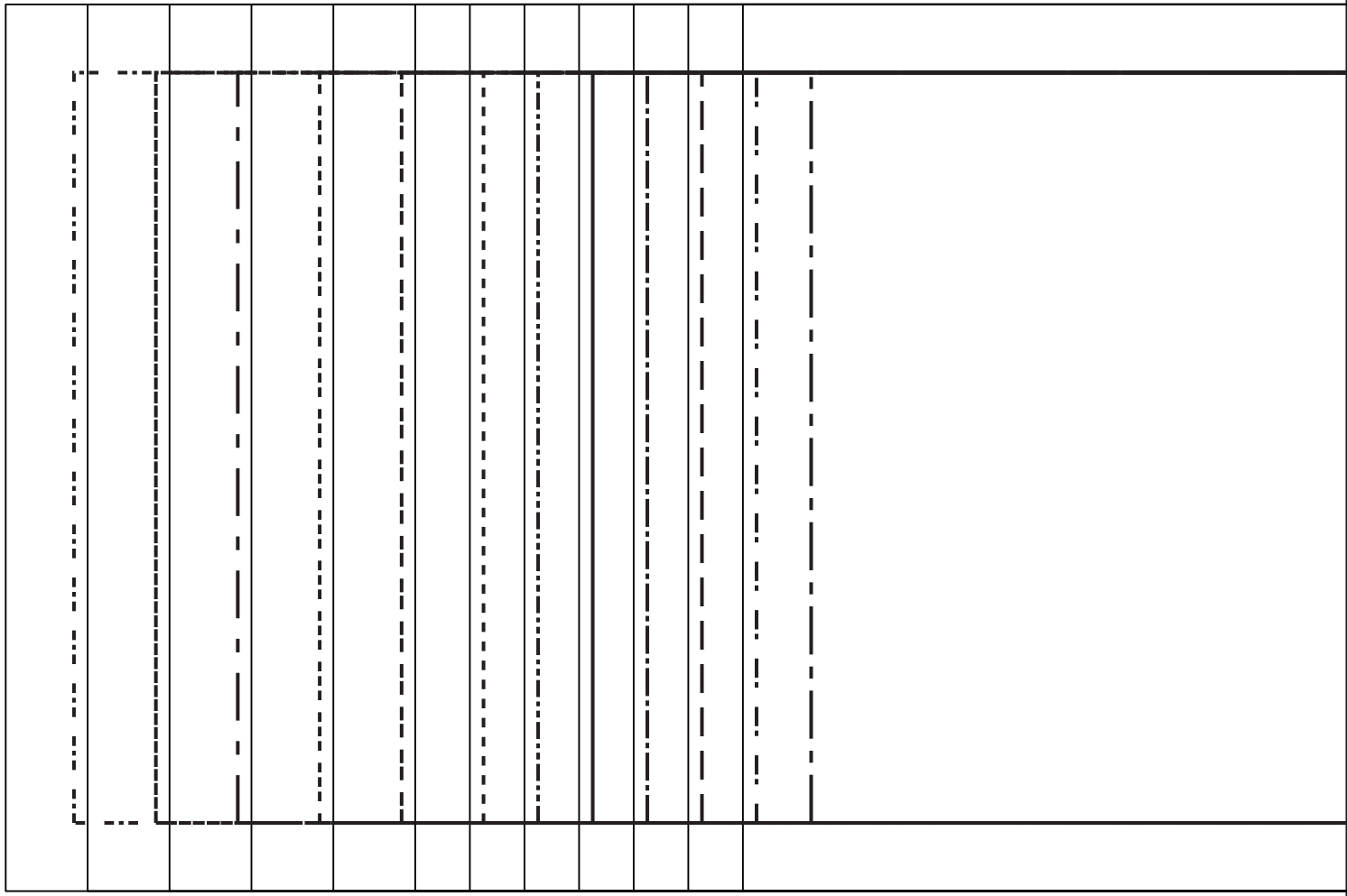
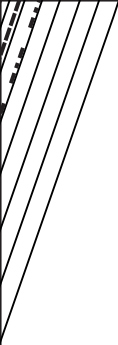

MV/MDV/CF

MR/MDS/CB

**IDA - E**



*Victor*  
LA MAISON

