

Patroonschema / Schéma du Patron / Pattern Diagram /
Übersichtsplan zum Zusammenkleben

Leia

Jas / Veste / Jacket

Maten / Tailles / Sizes:

.....	30
-----	32
- - - - -	34
- . - . -	36
- - - - -	38
- . - - -	40
—————	42
- - - - -	44
- - - - -	46
- - - - -	48

Patroondelen / Pièces du patron / Pattern pieces:

- A** voorpand / devant / front
- B** rugpand / dos / back
- C** mouw / manche / sleeve
- D** kap / capuche / hood
- E** kap rug / partie milieu capuche /
hood back
- F** zak / poche / pocket

1	2	3	4	5	6
7	8	9	10	11	12
13	14	15	16	17	18
19	20	21	22	23	24
25	26	27	28		

Controlevierkant / Carré de controle / Test square / Kontrollquadrat

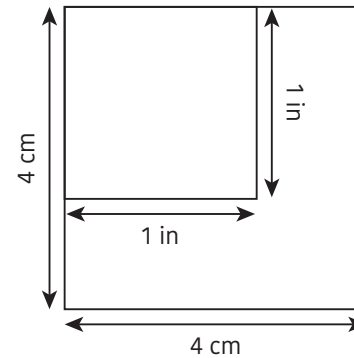

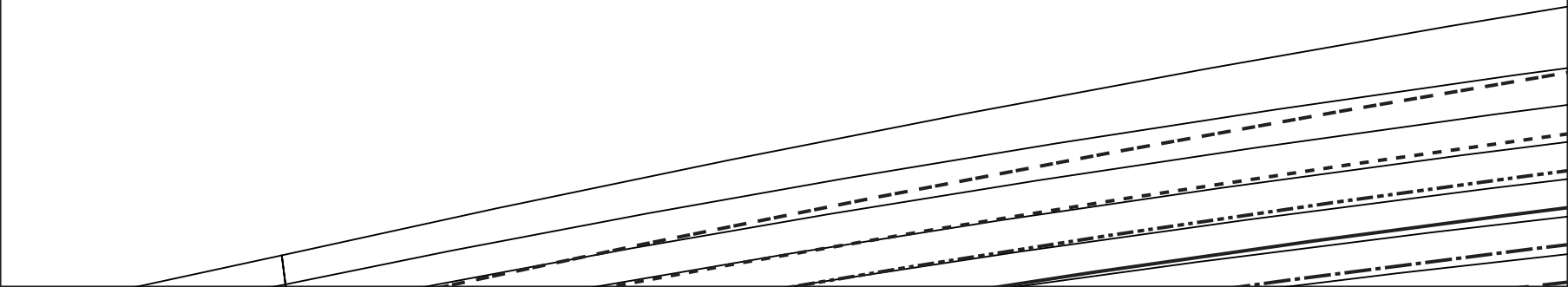

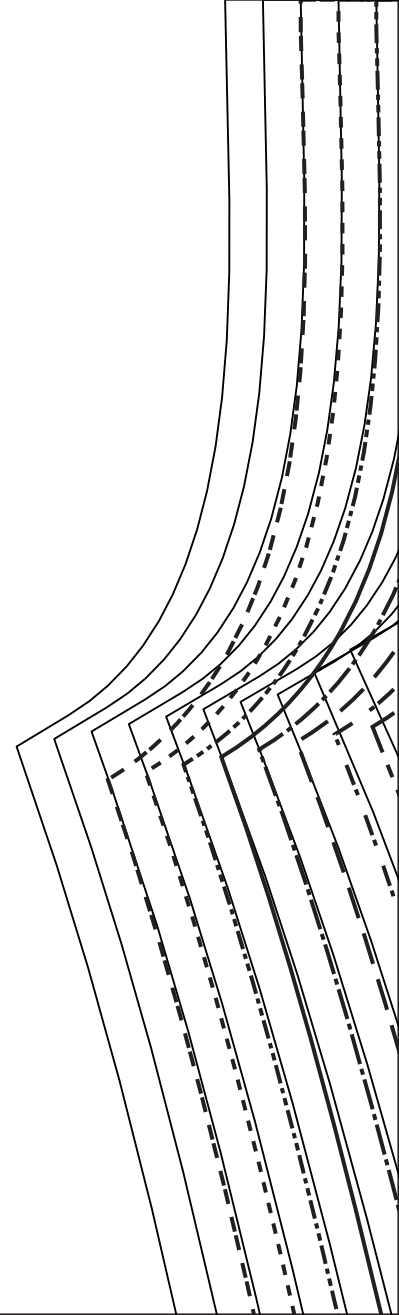
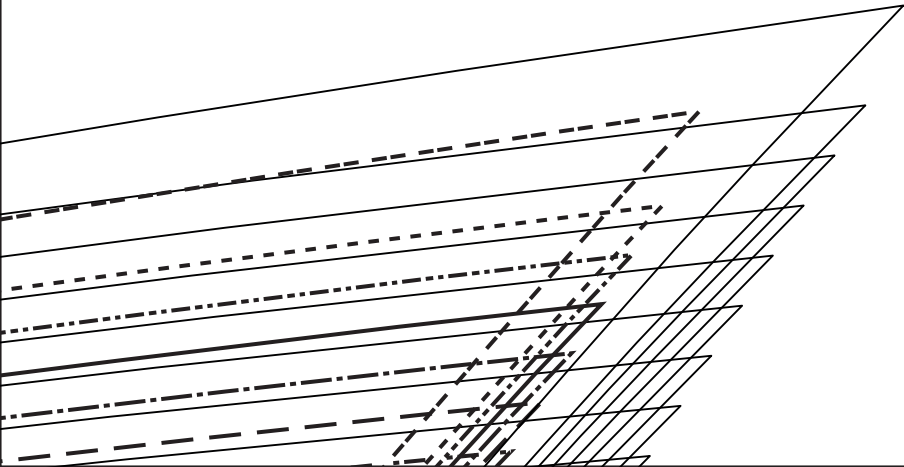

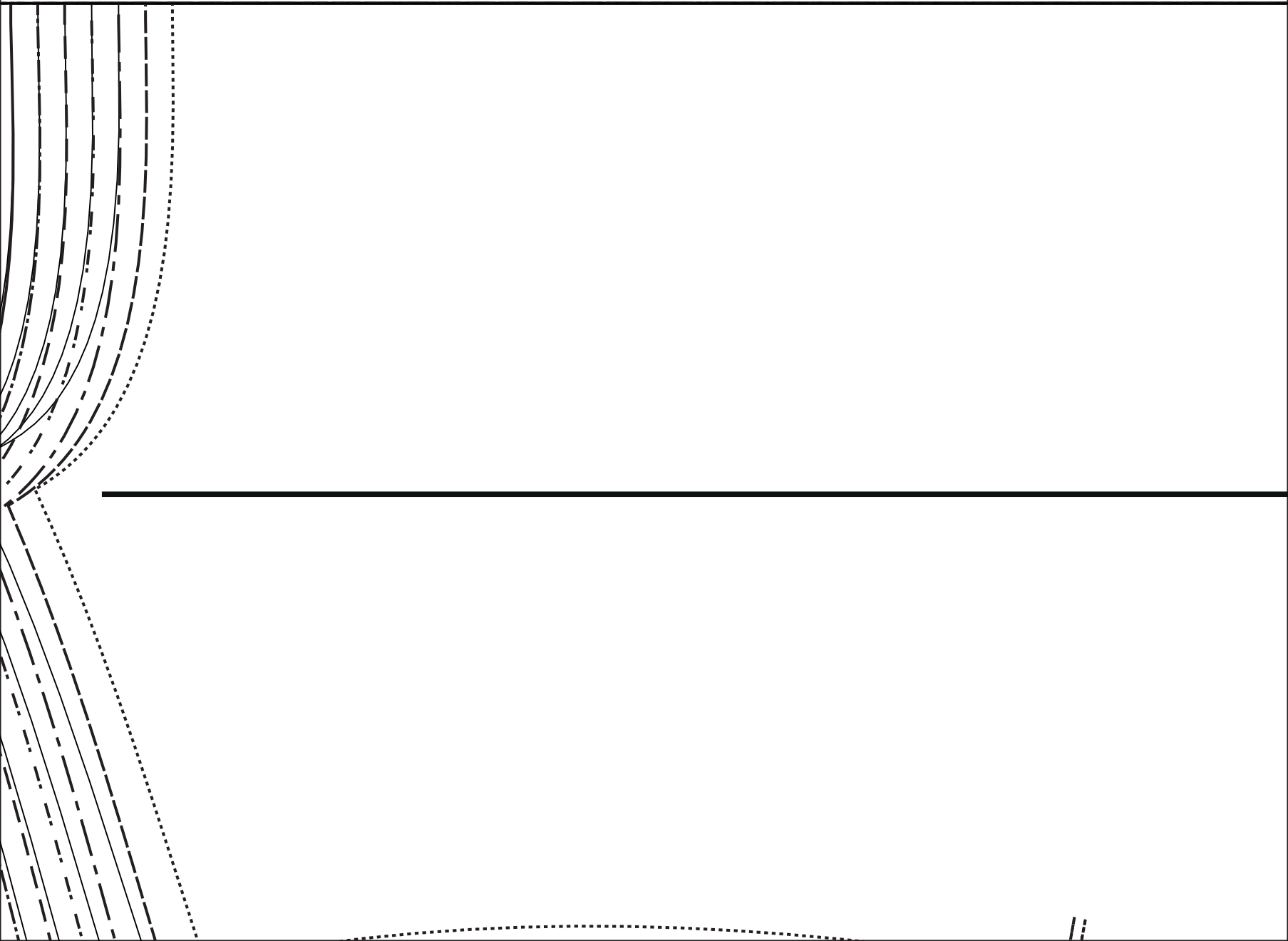



LEIA - B

Victor LA MAISON

6

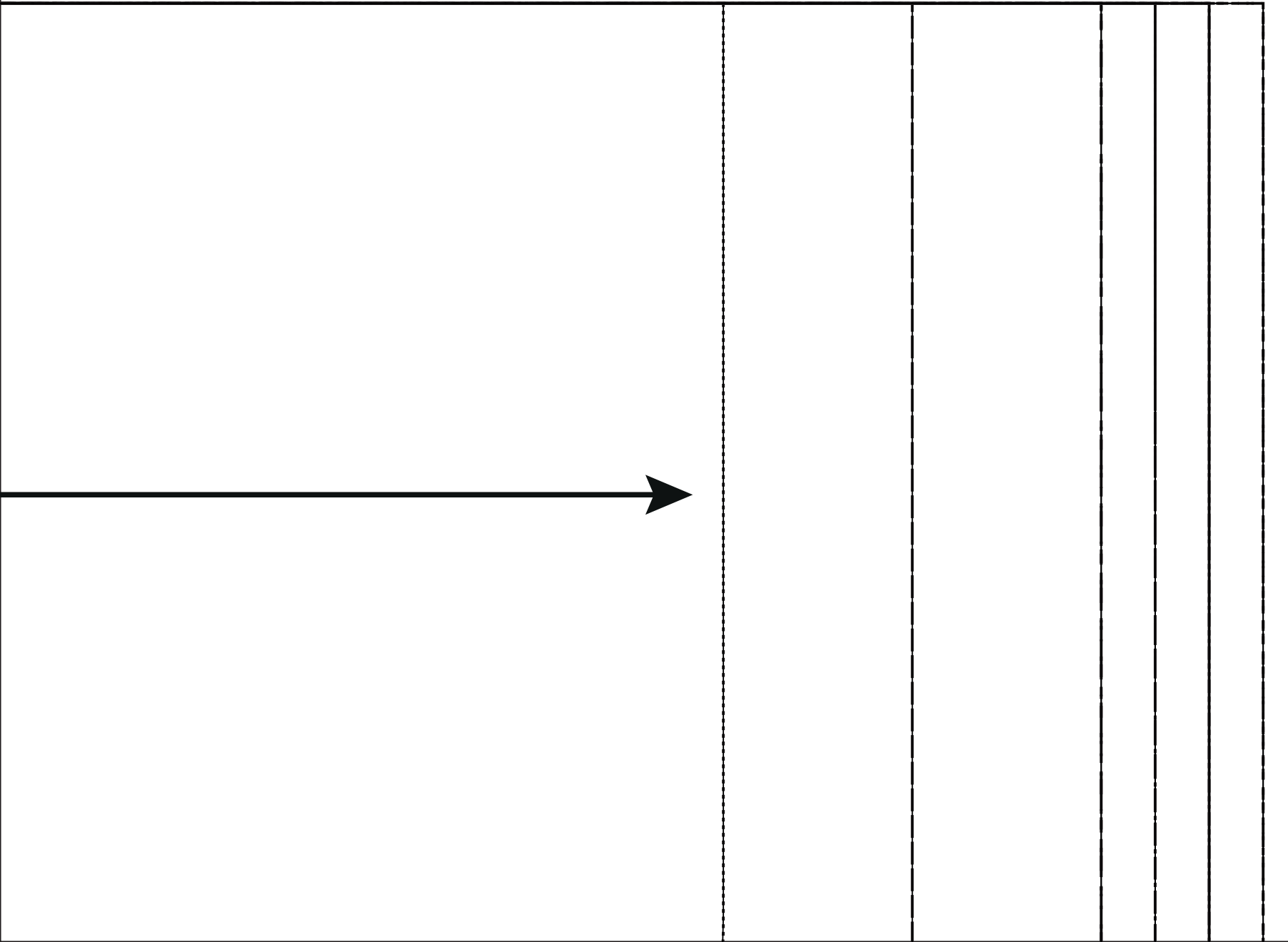

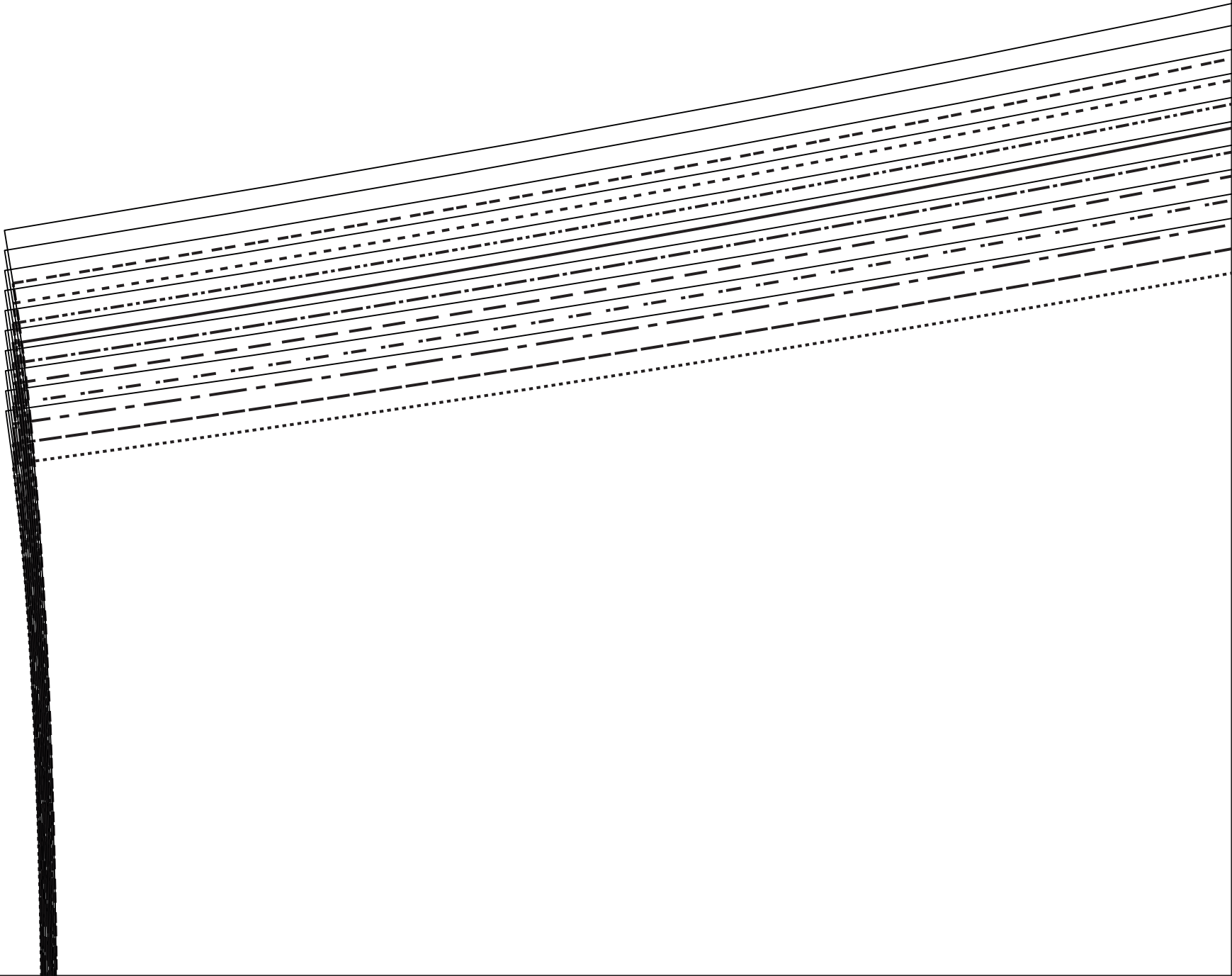

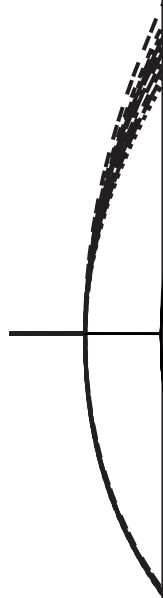
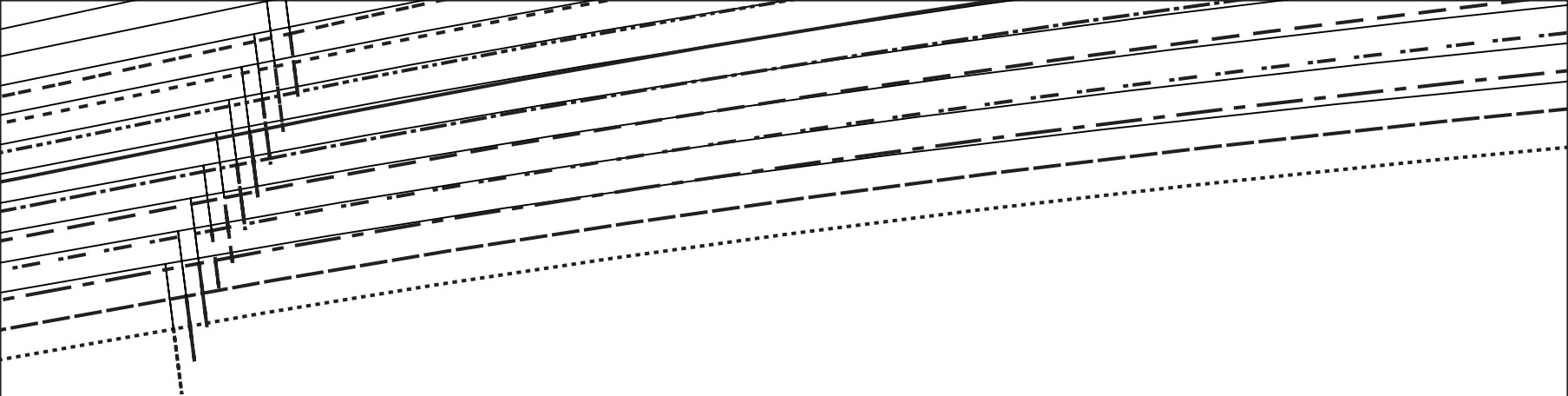

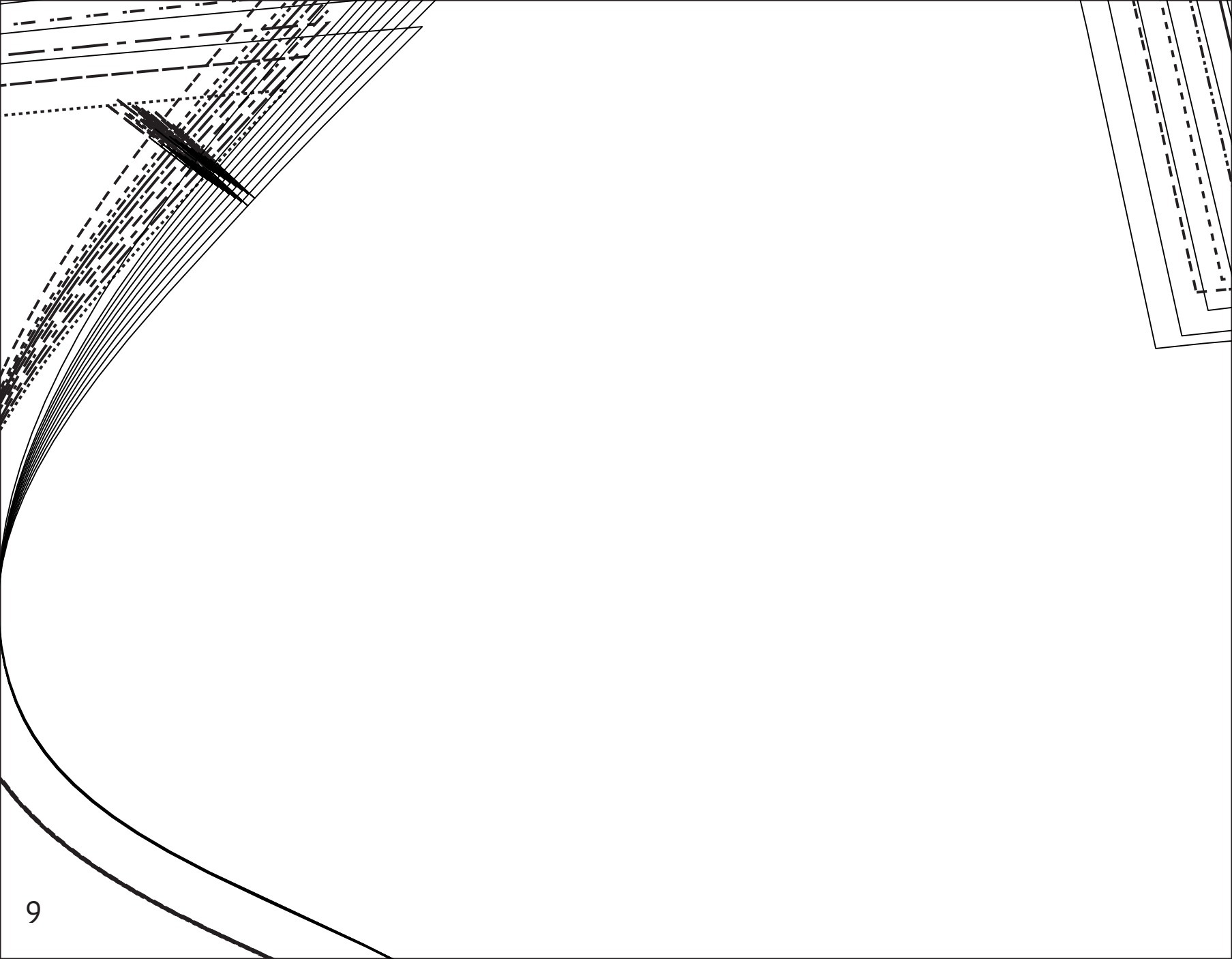

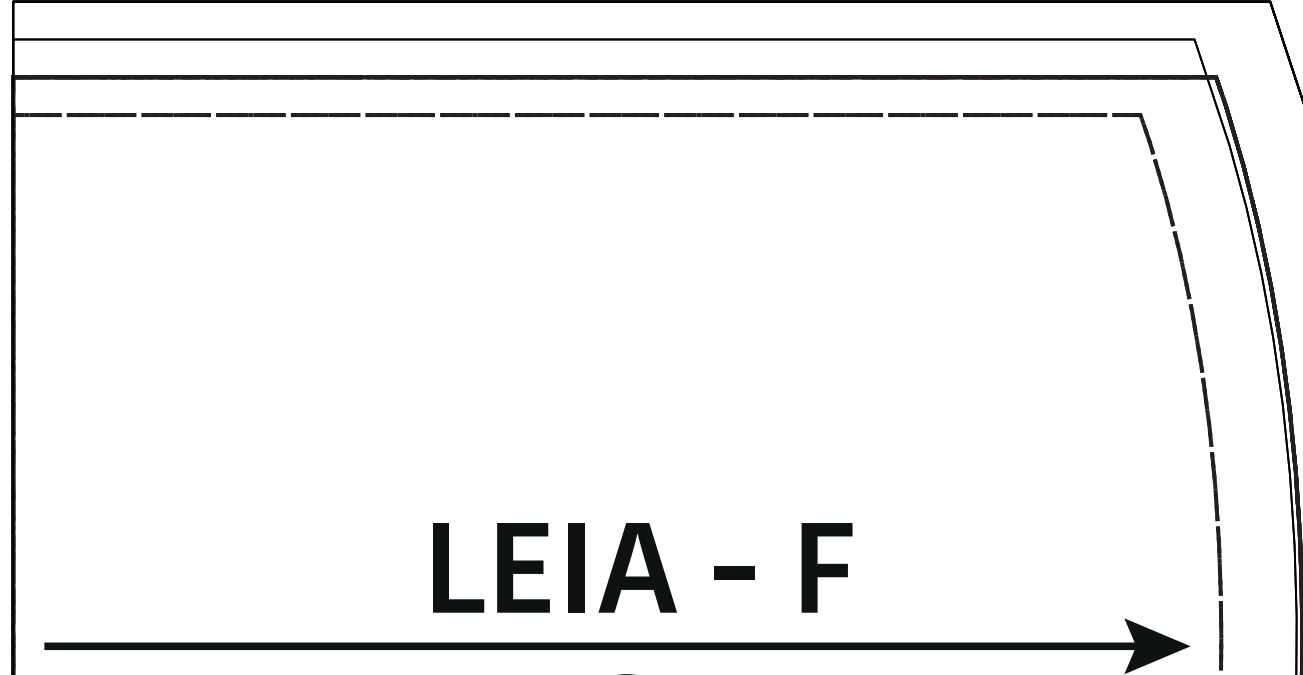
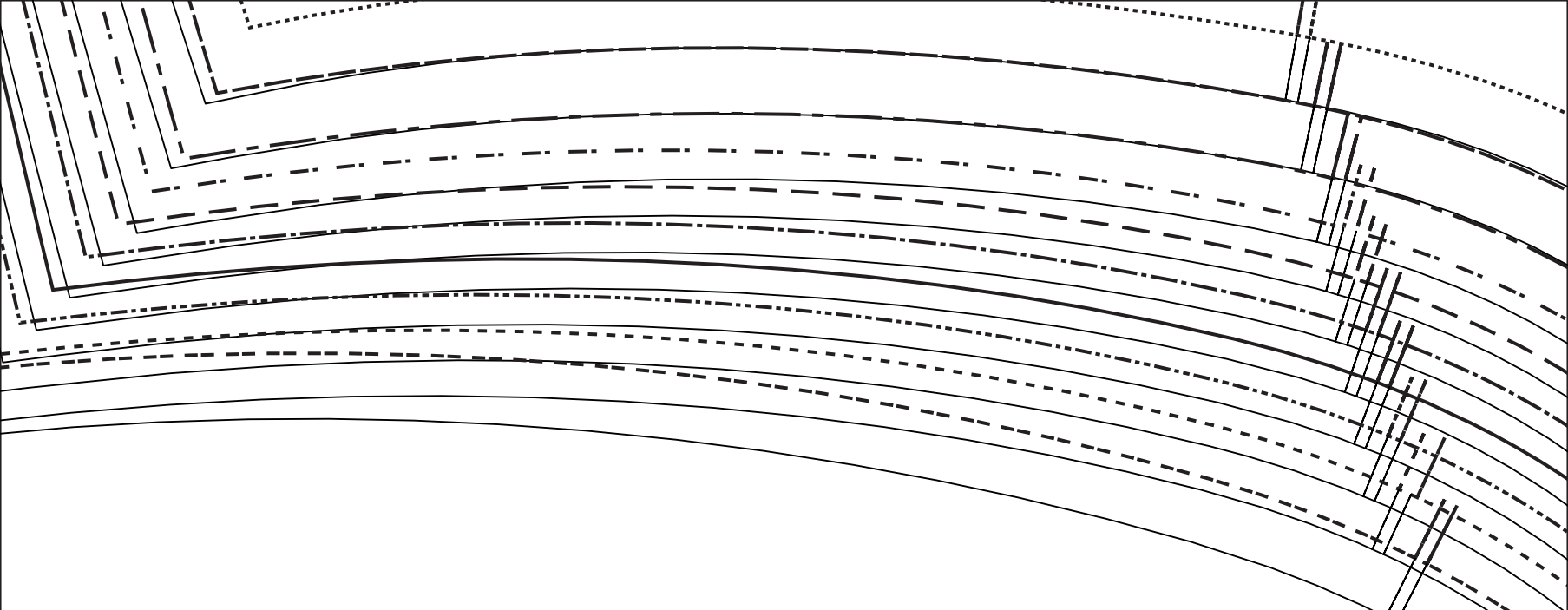

LEIA - F

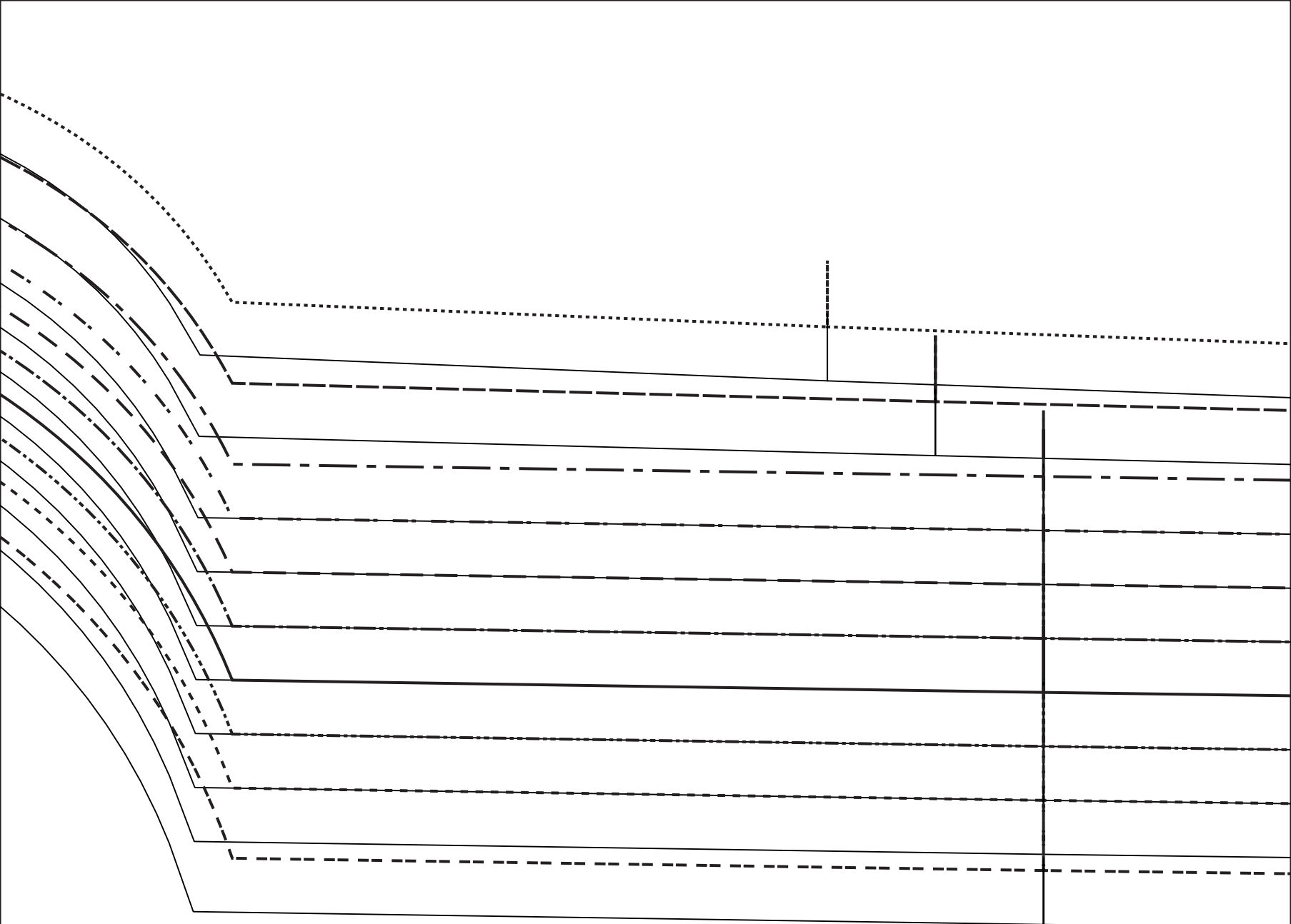

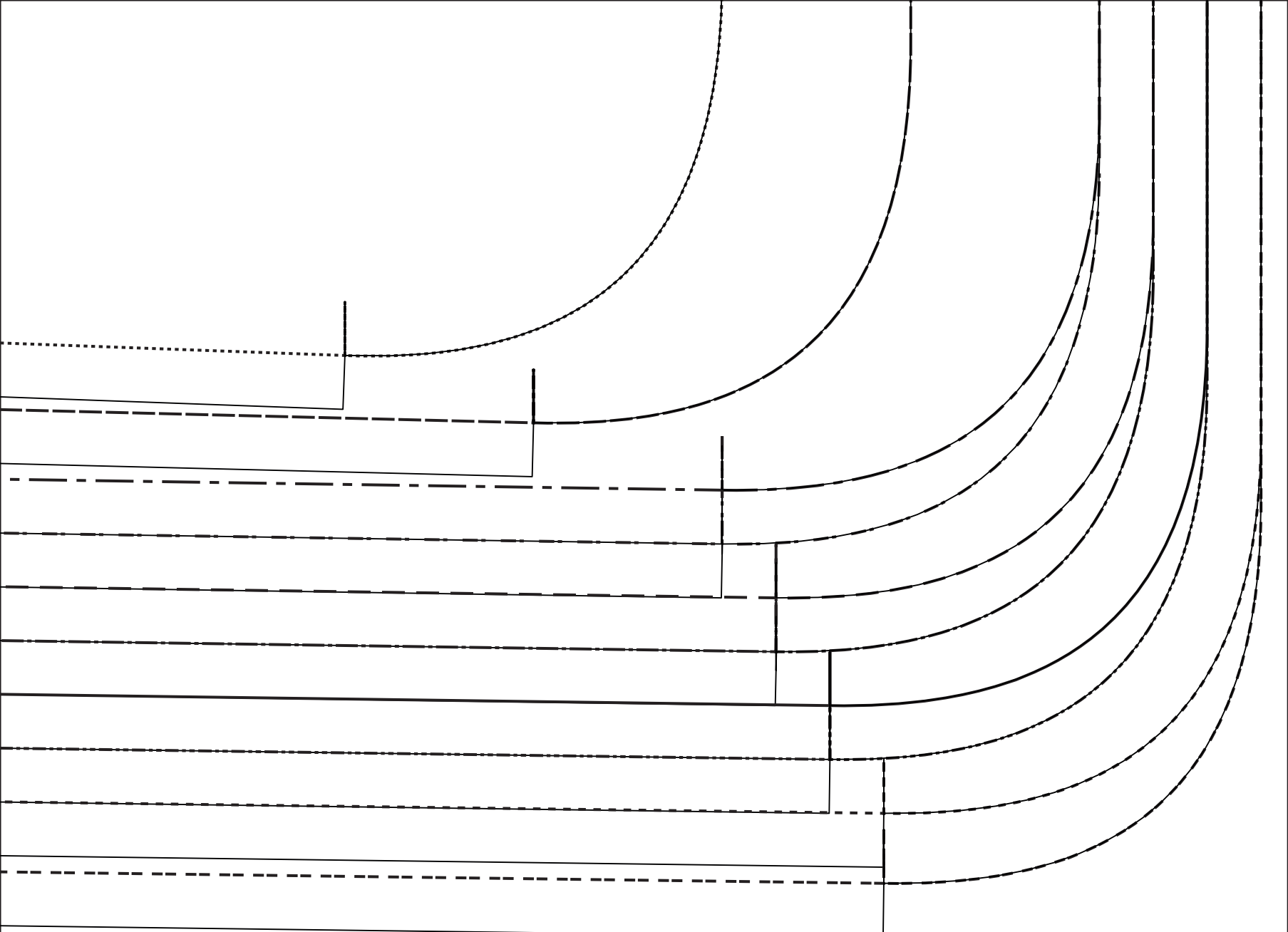



Victor
LA MAISON

LEIA - C

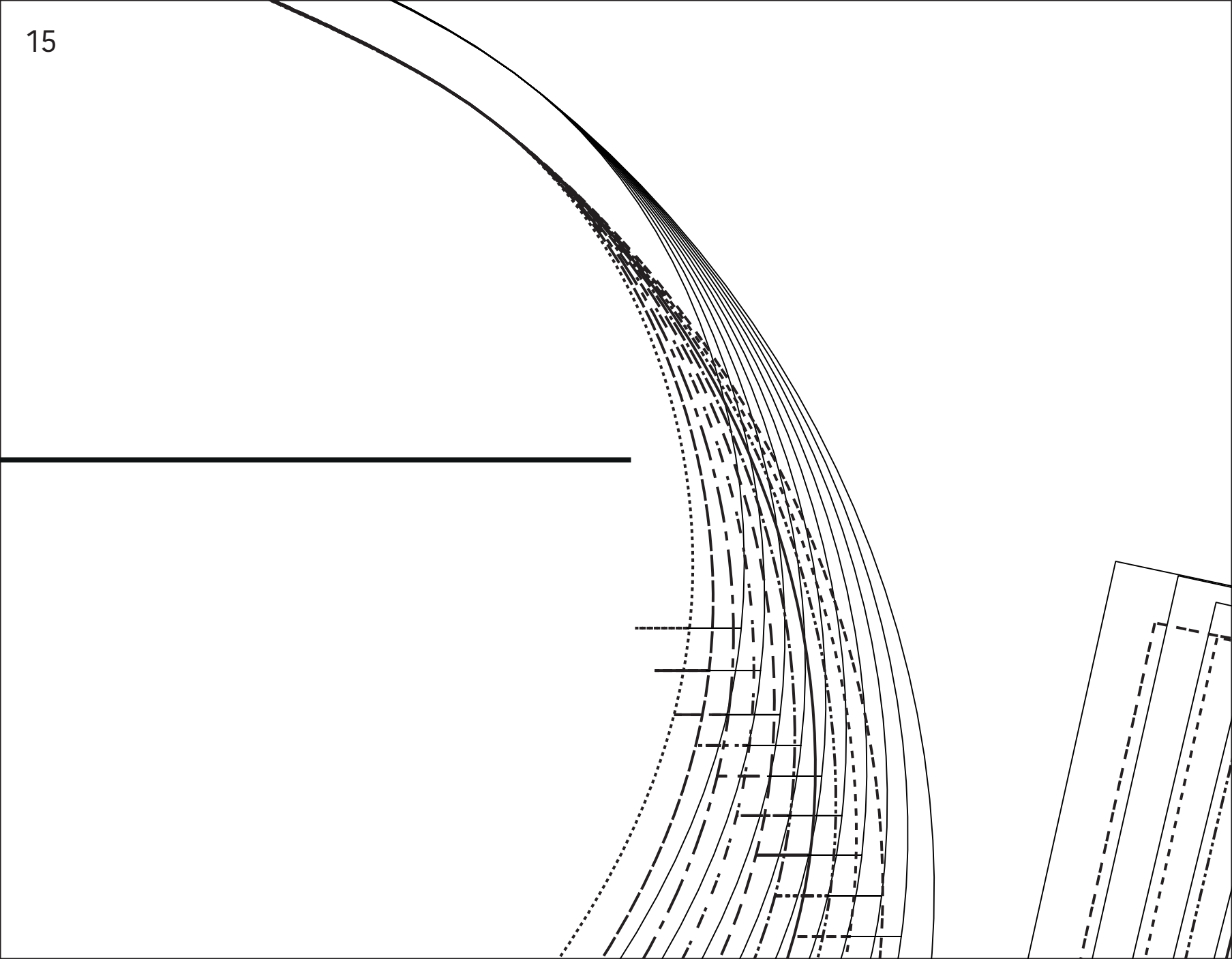

LA MAISON

Victor



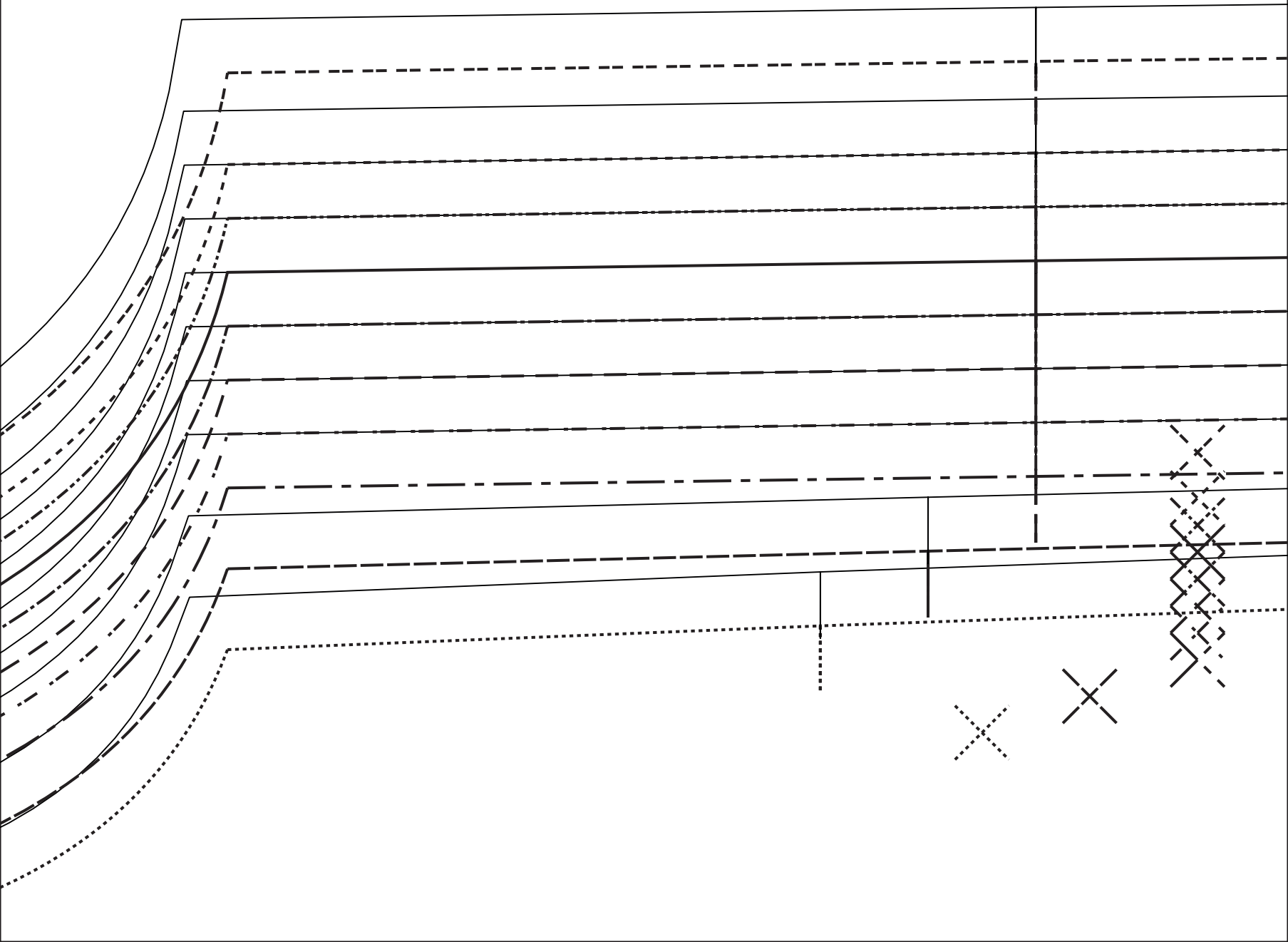

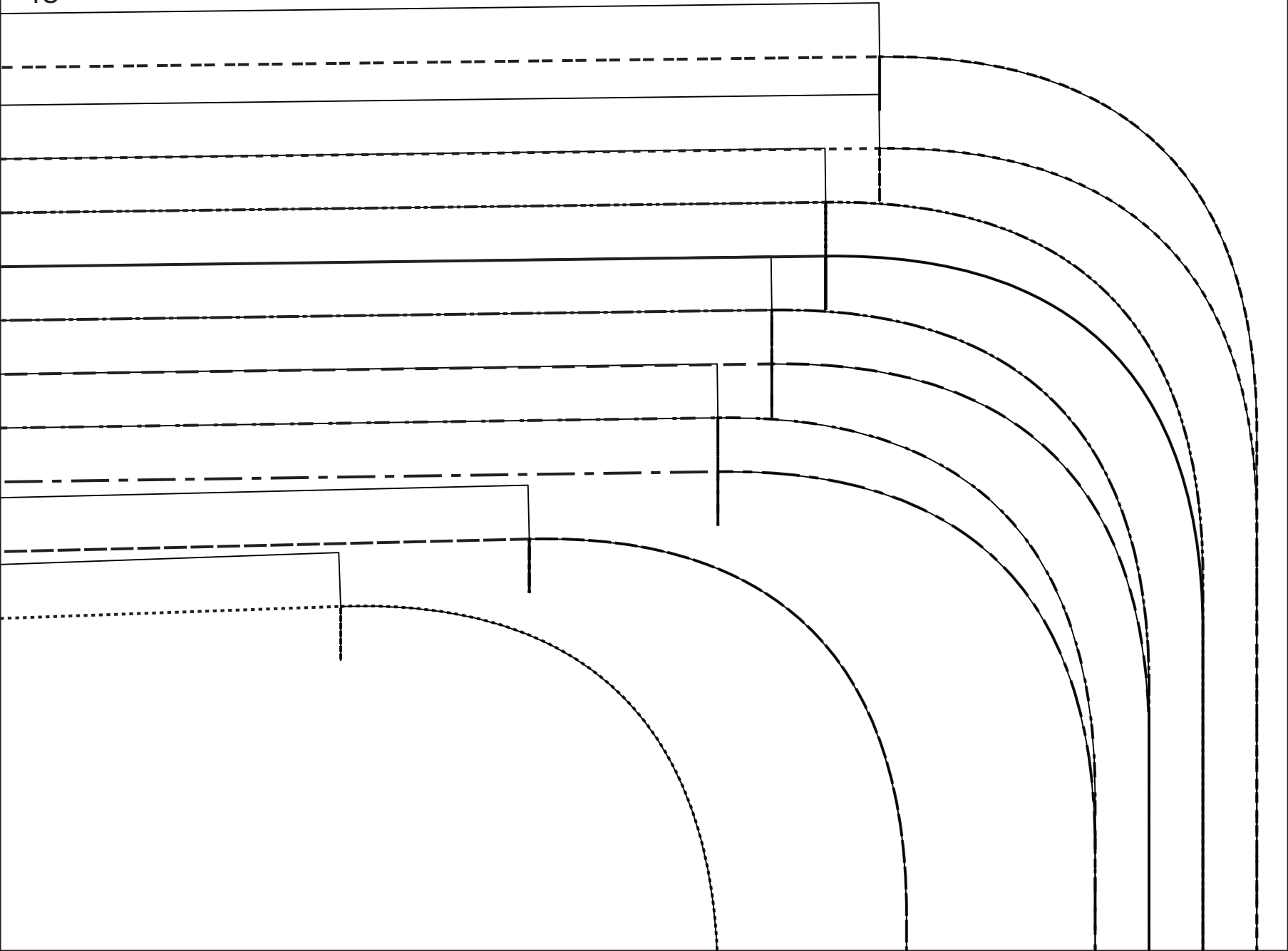

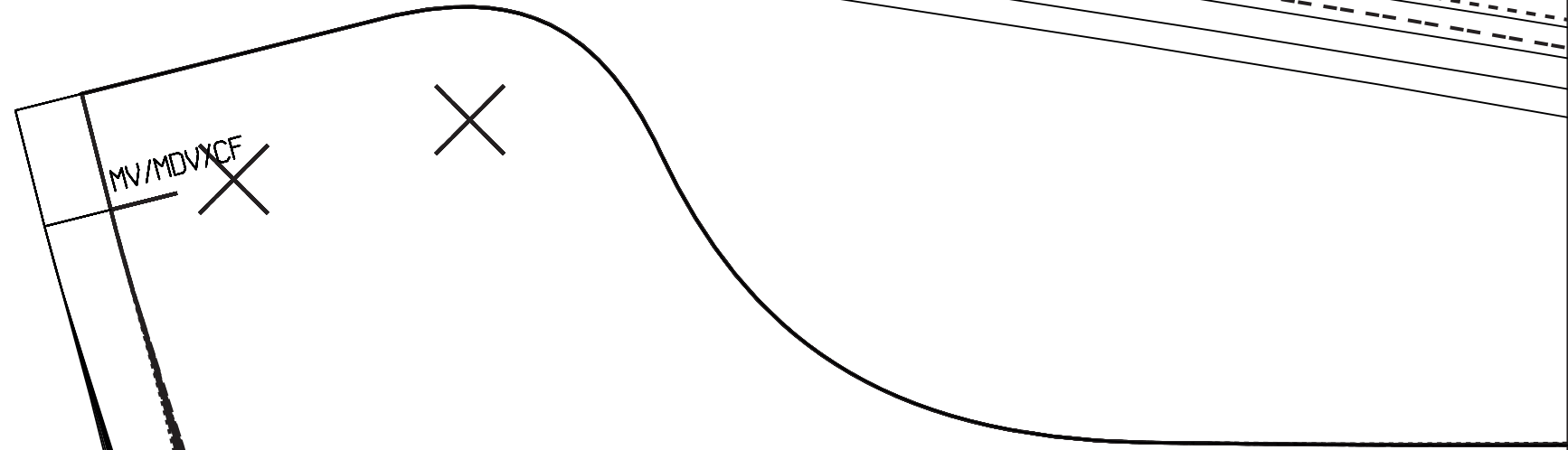

MV/MDVXCF

Victor

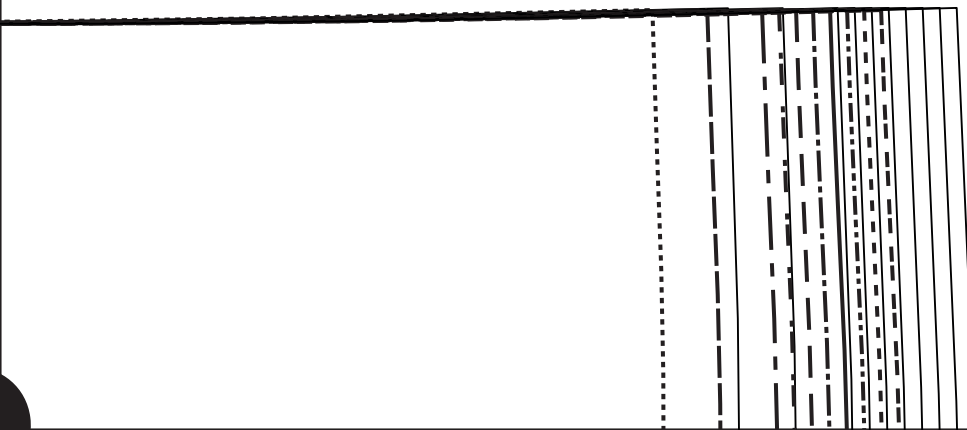
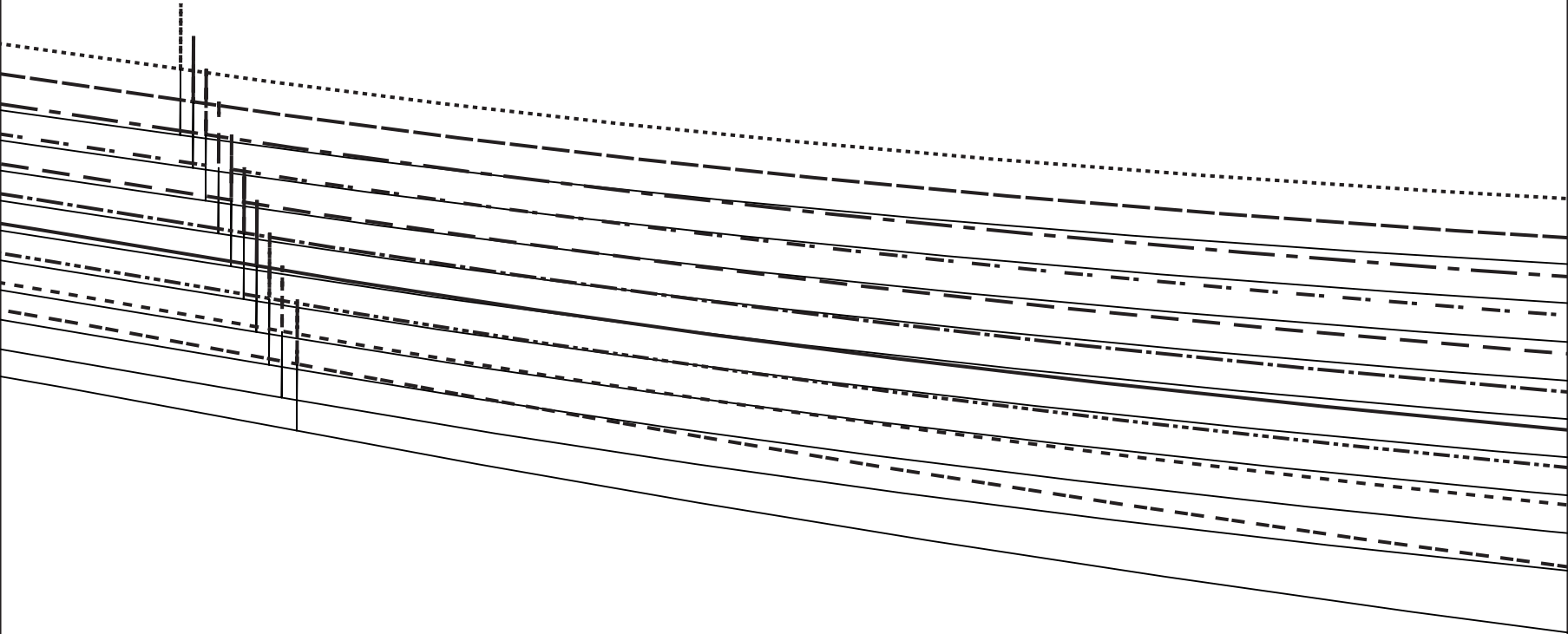

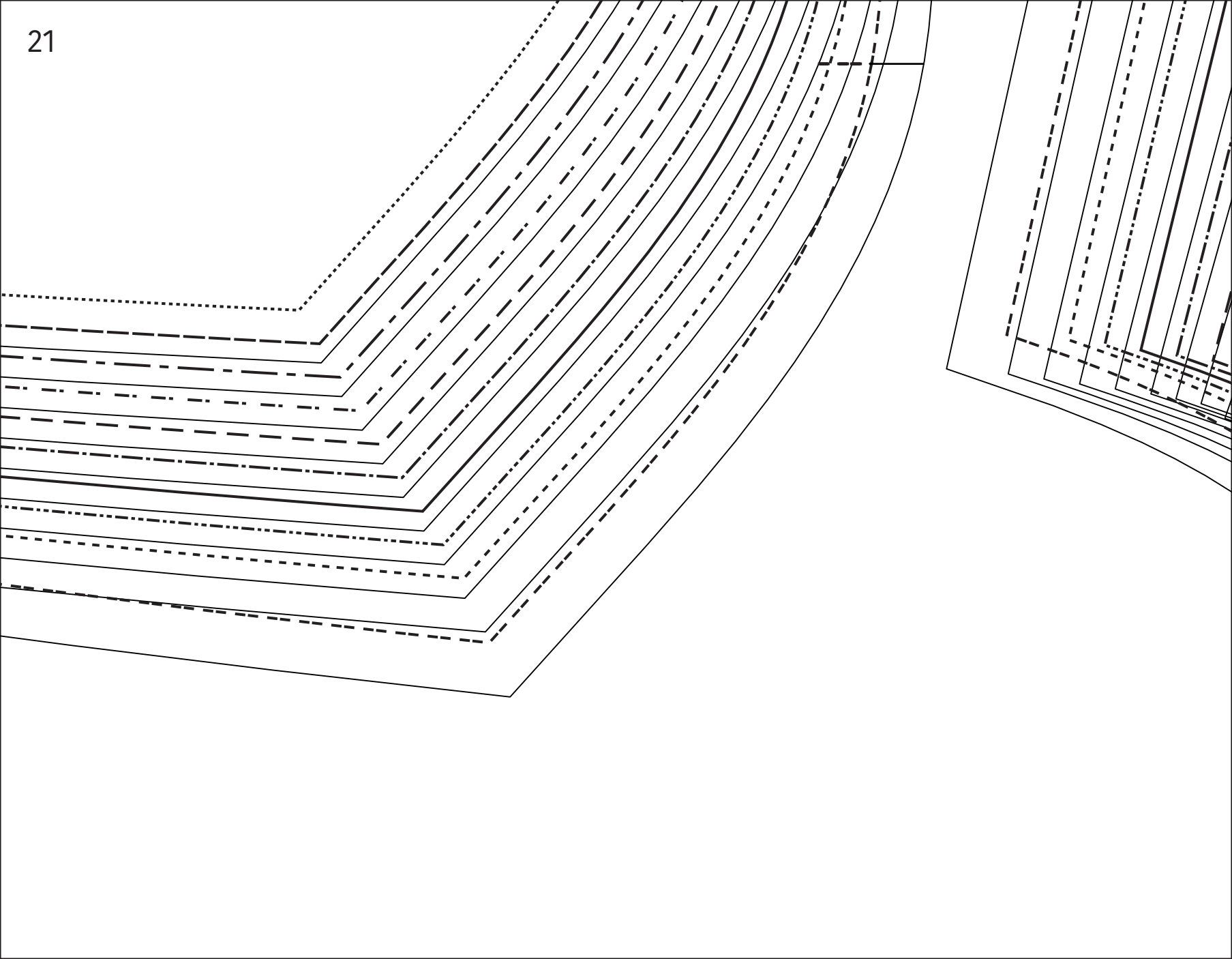

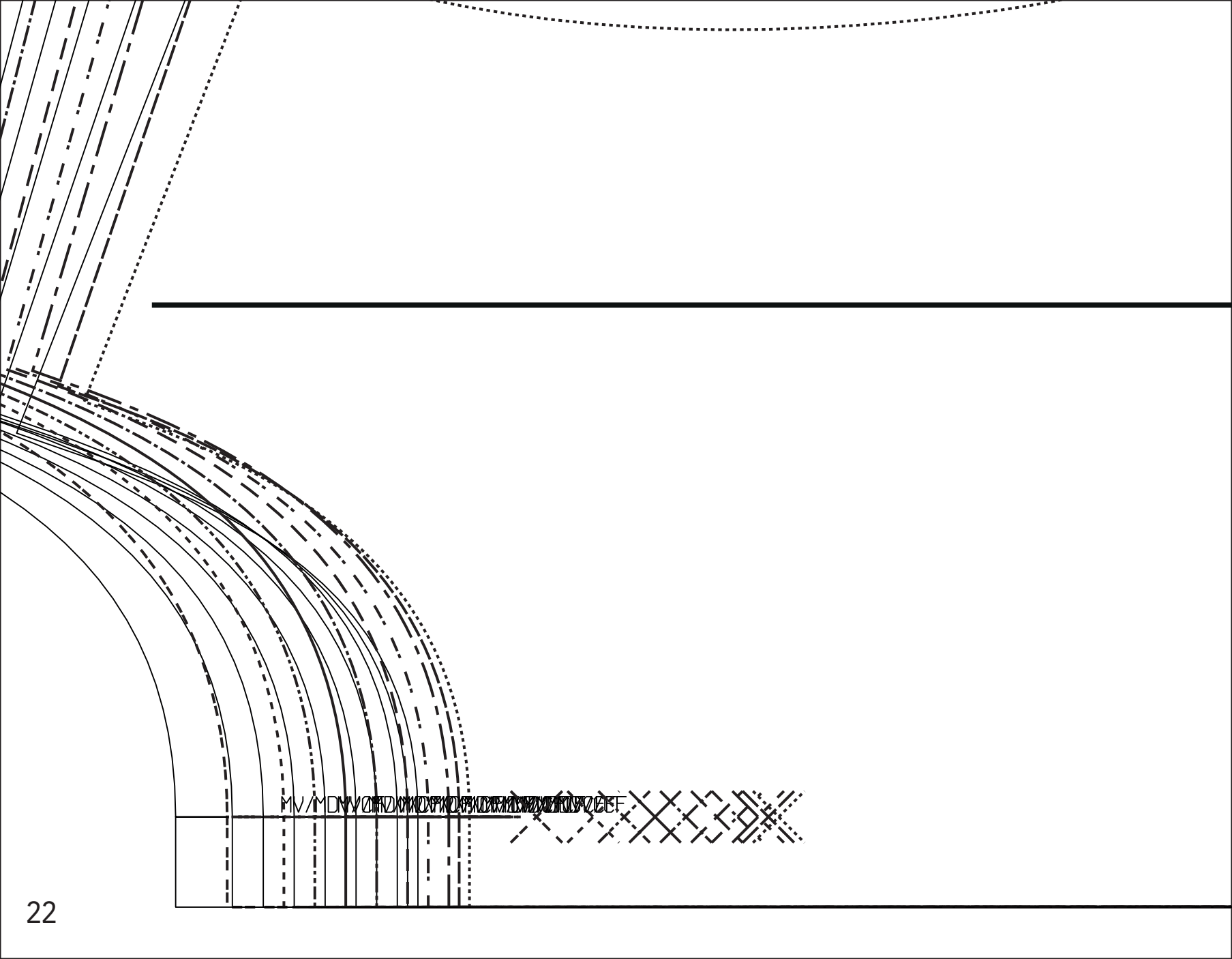

LEIA - A

Victor LA MAISON



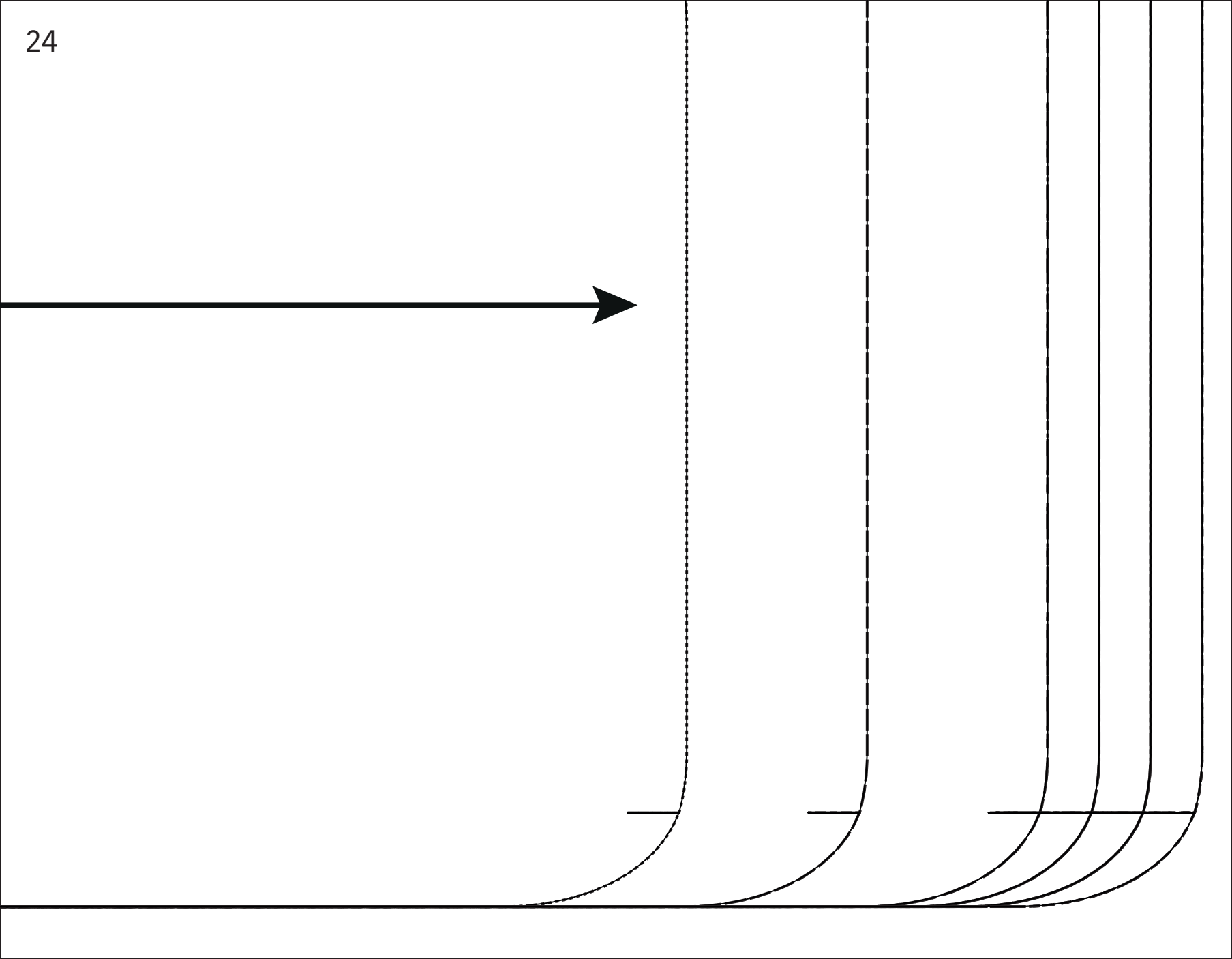



LEIA - D

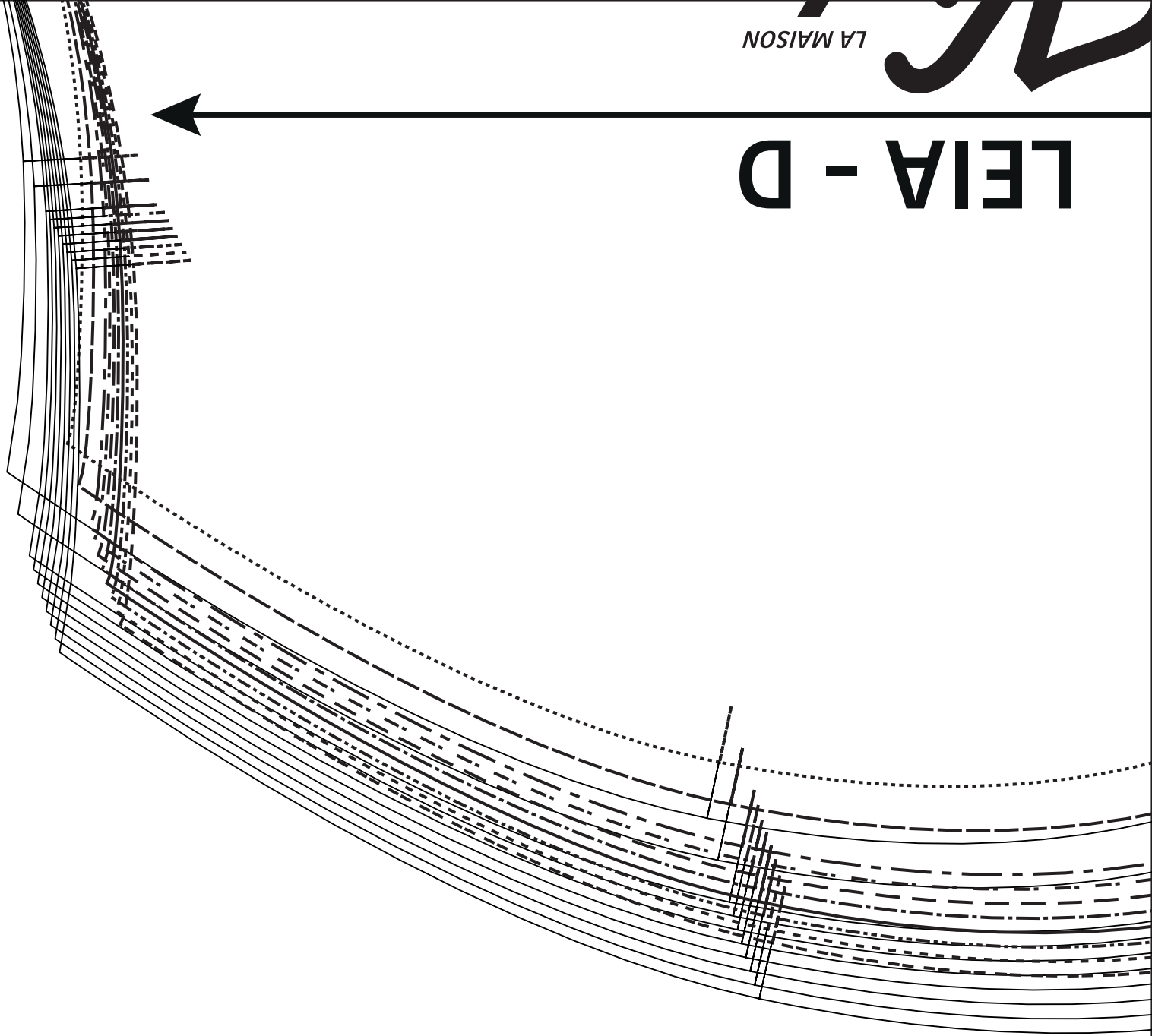

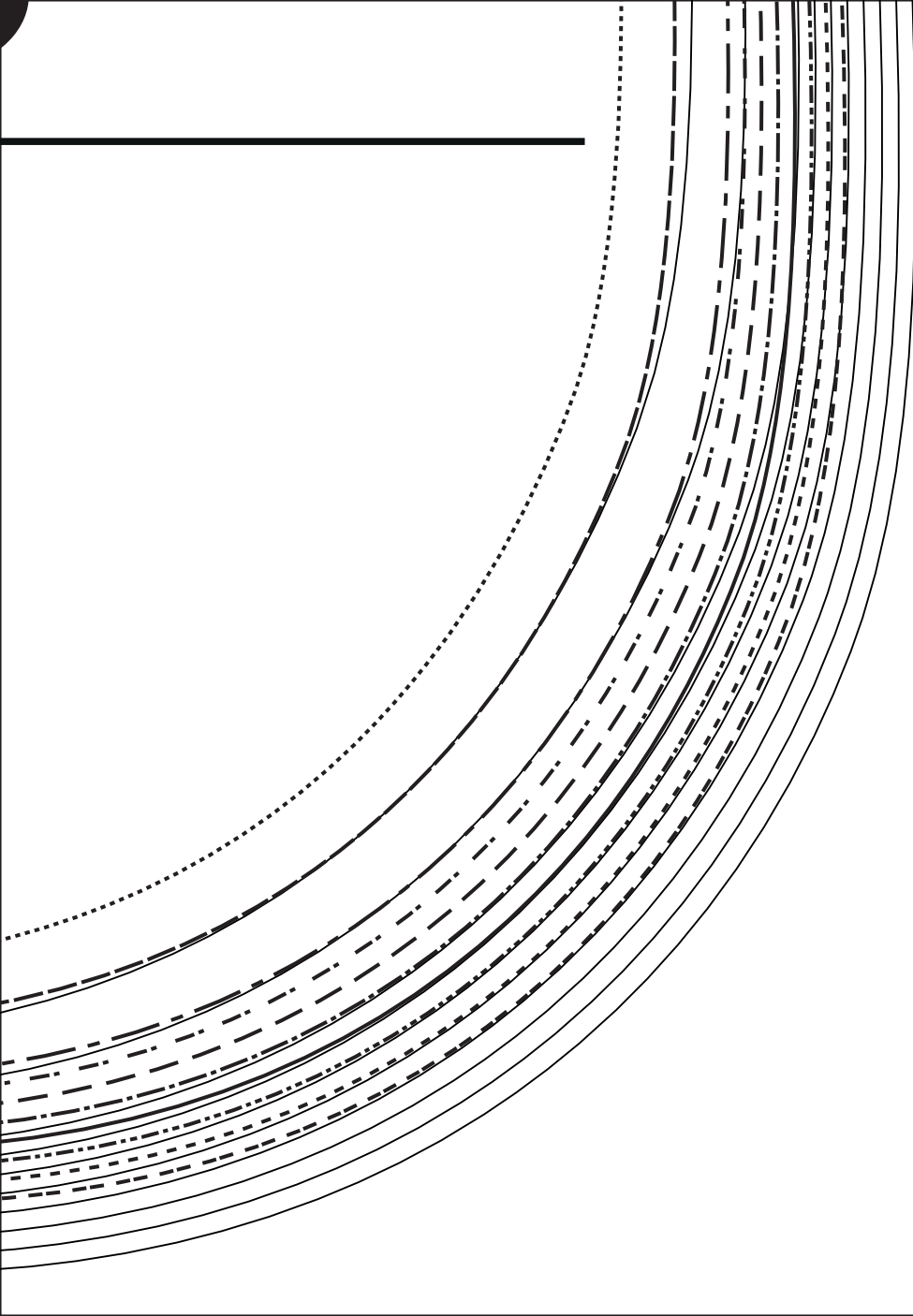

--	--	--	--	--	--	--	--	--	--



LEIA - E

Victor LA MAISON

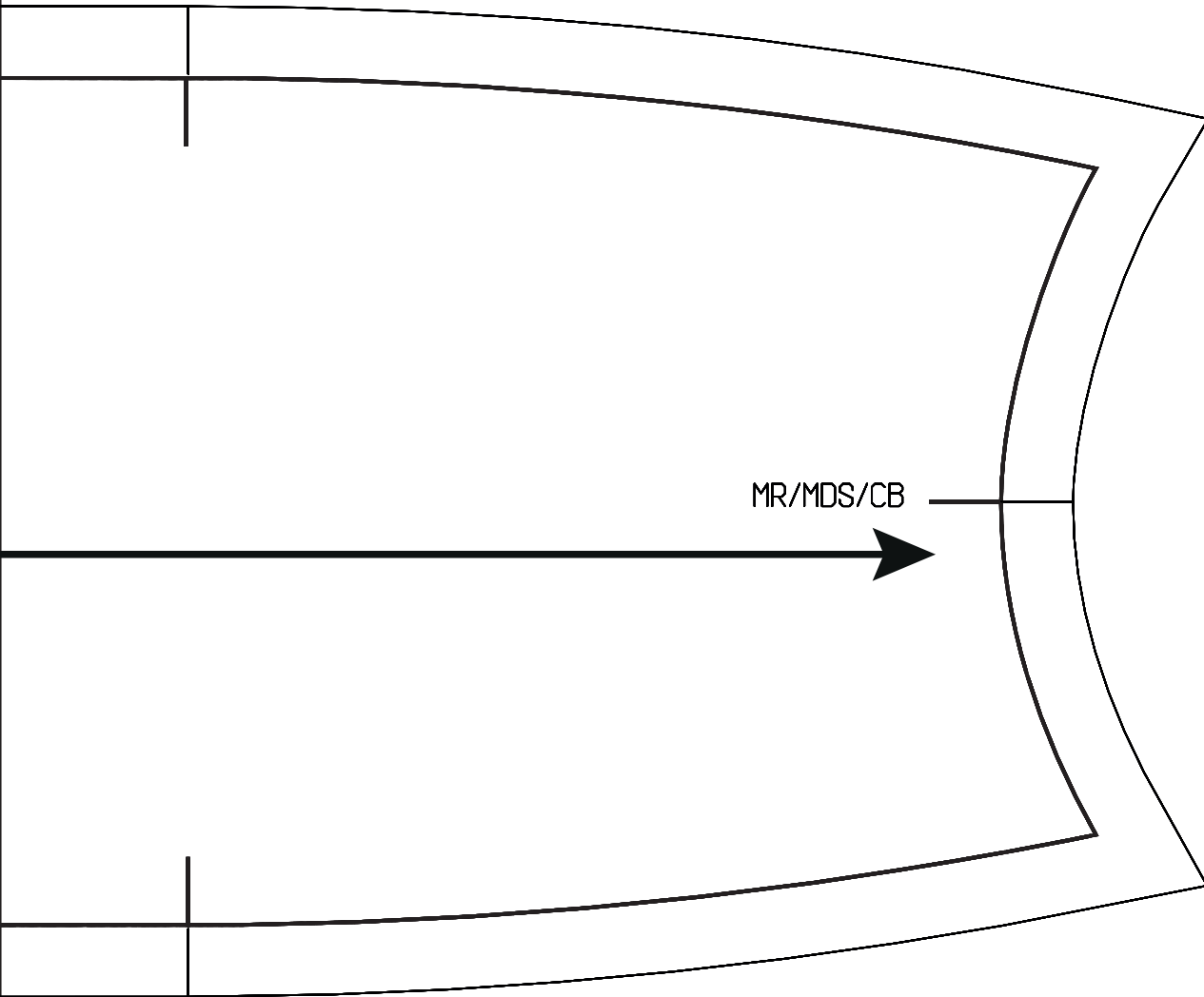

MR/MDS/CB