

Avery

Jurk / Robe / Dress

Maten / Tailles / Sizes:

-----	34
-----	36
-----	38
-----	40
—————	42
-----	44
-----	46
-----	48
-----	50
-----	52
-----	54
-----	56

Patroondelen / Pièces du patron / Pattern pieces:

- A** voorpand / devant / front panel
- B** rugpand / dos / back panel
- C** mouw / manche / sleeve
- D** kraag VP / col DV / neck trim front
- E** kraag RP / col DS / neck trim BP
- F** knopenpat / patte à boutons /
button placket
- G** polsboord / bord manchette /
wrist trim
- H** zak / poche / pocket

Patroonschema / Schéma du Patron / Pattern Diagram / Übersichtsplan zum Zusammenkleben

1	2	3	4	5	6
7	8	9	10	11	12
13	14	15	16	17	18
19	20	21	22	23	24
25	26	27	28	29	30
31	32	33	34	35	36
37					

Controlevierkant / Carré de controle / Test square / Kontrollquadrat

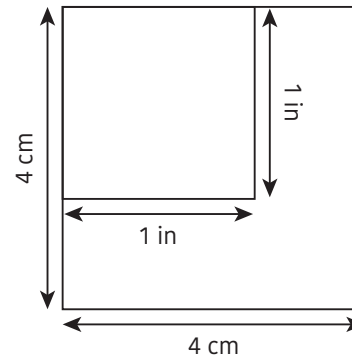

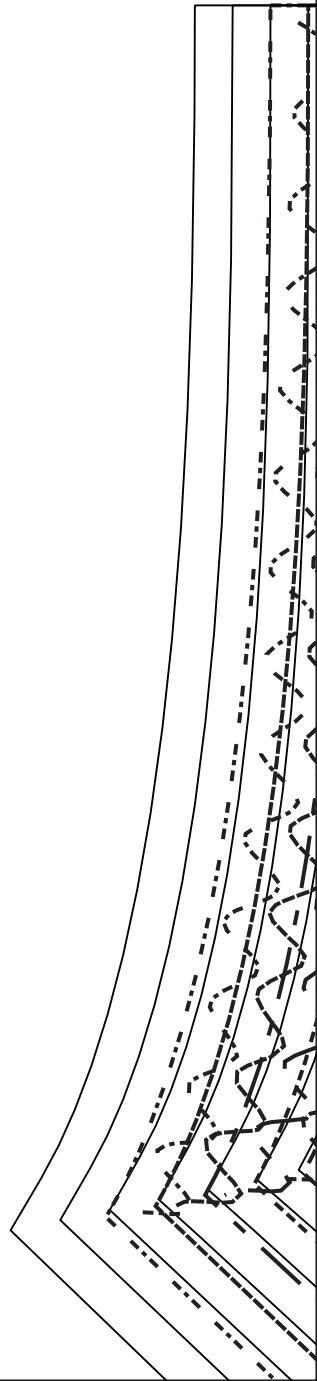
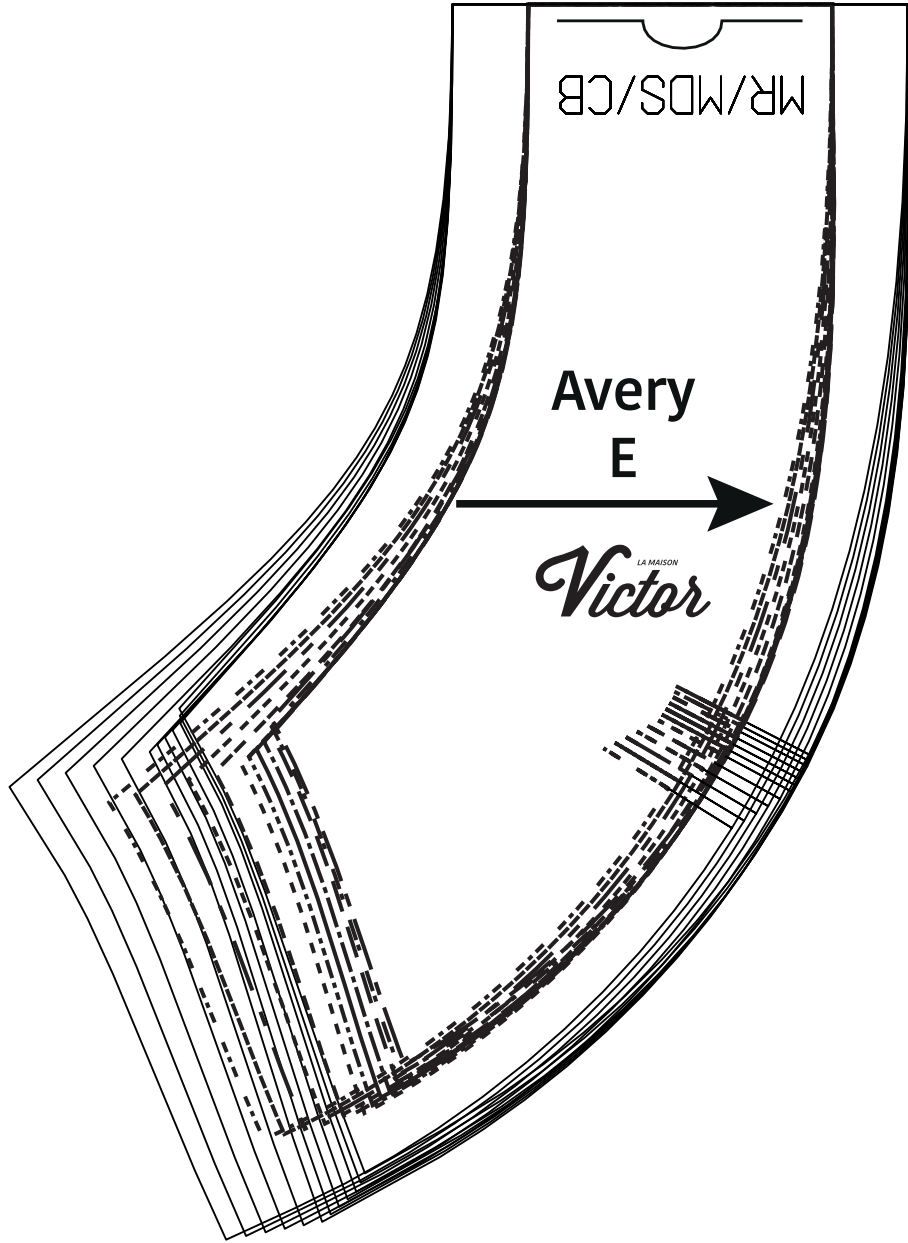

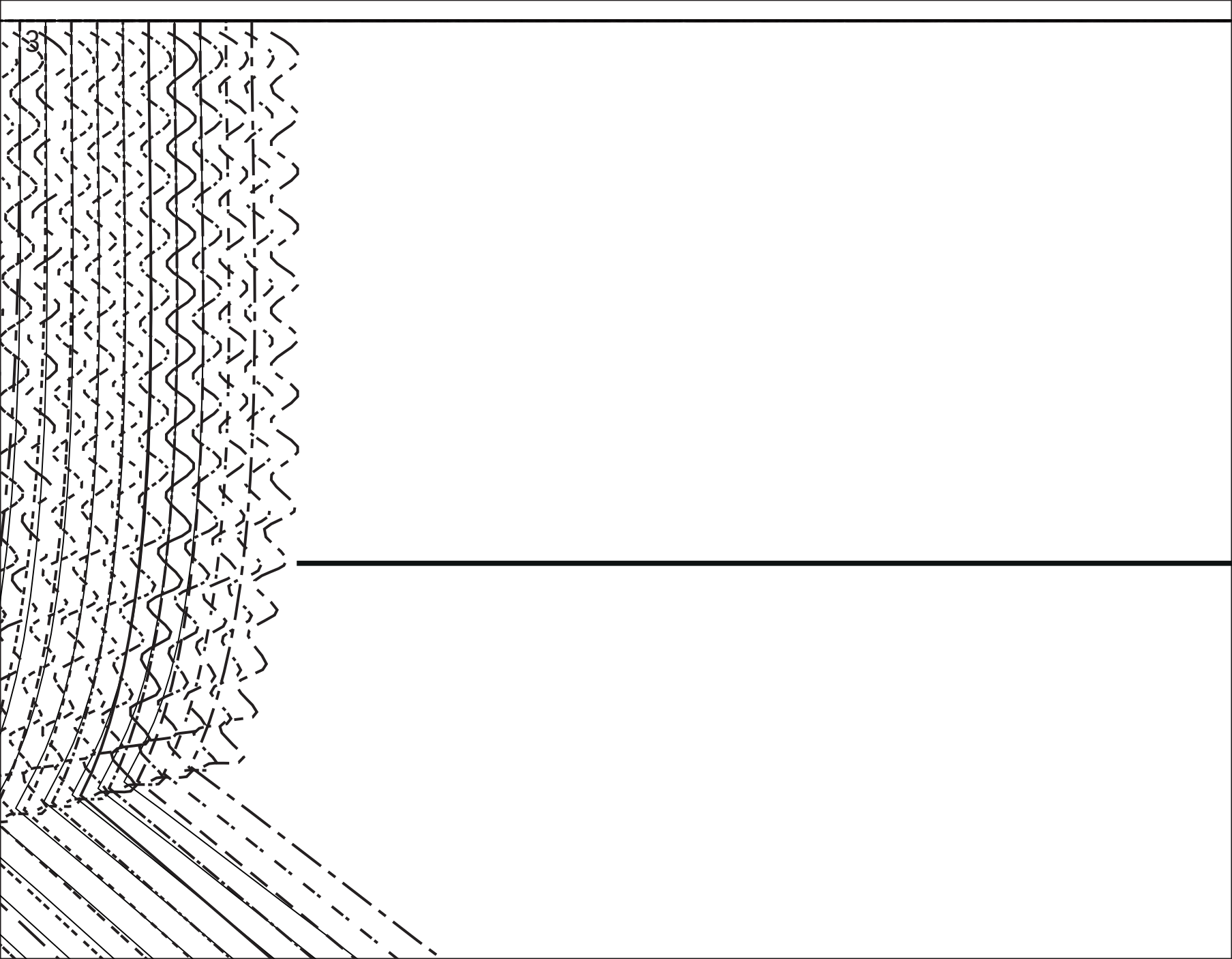



Avery - B

LA MAISON
Victor



--	--	--	--

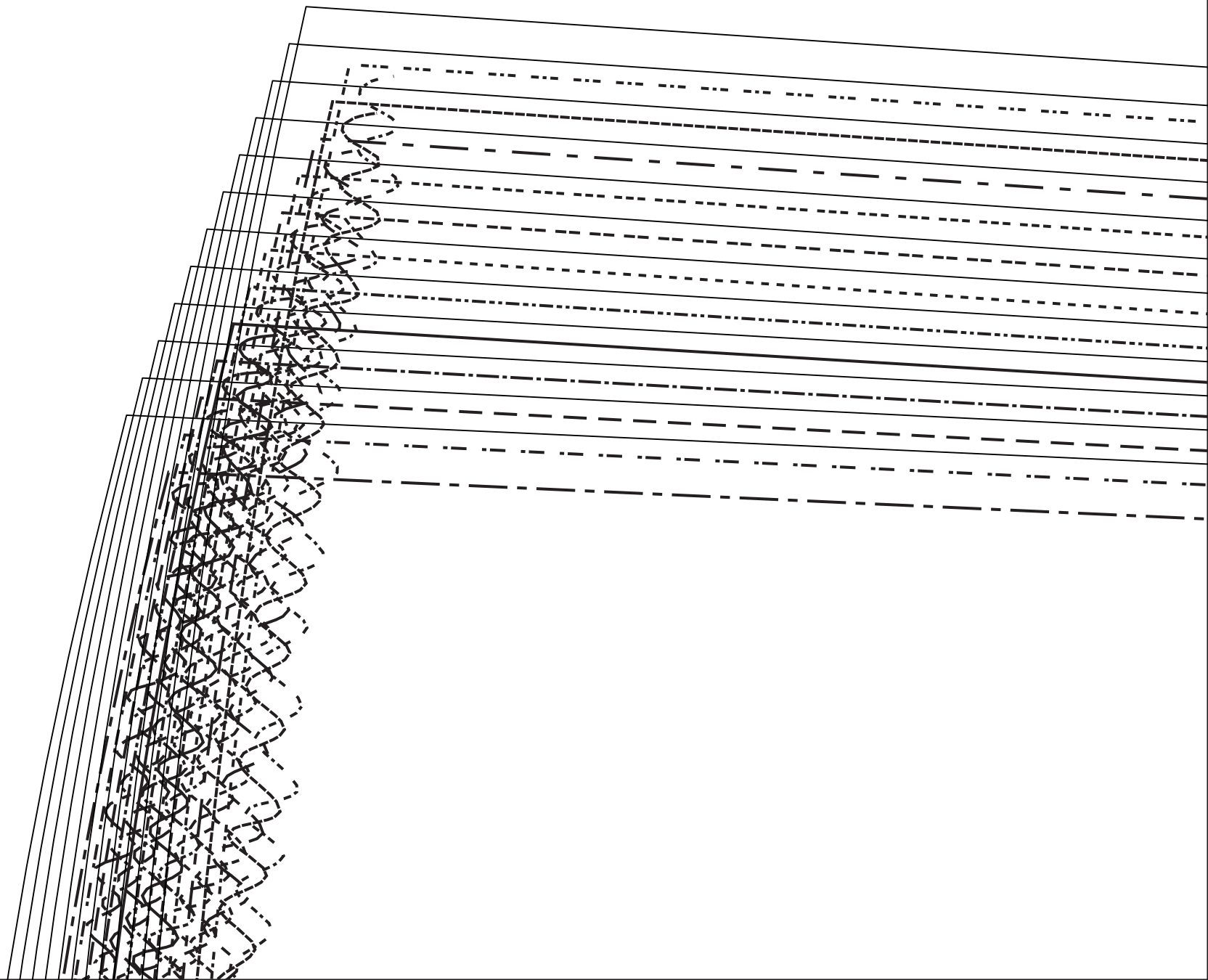

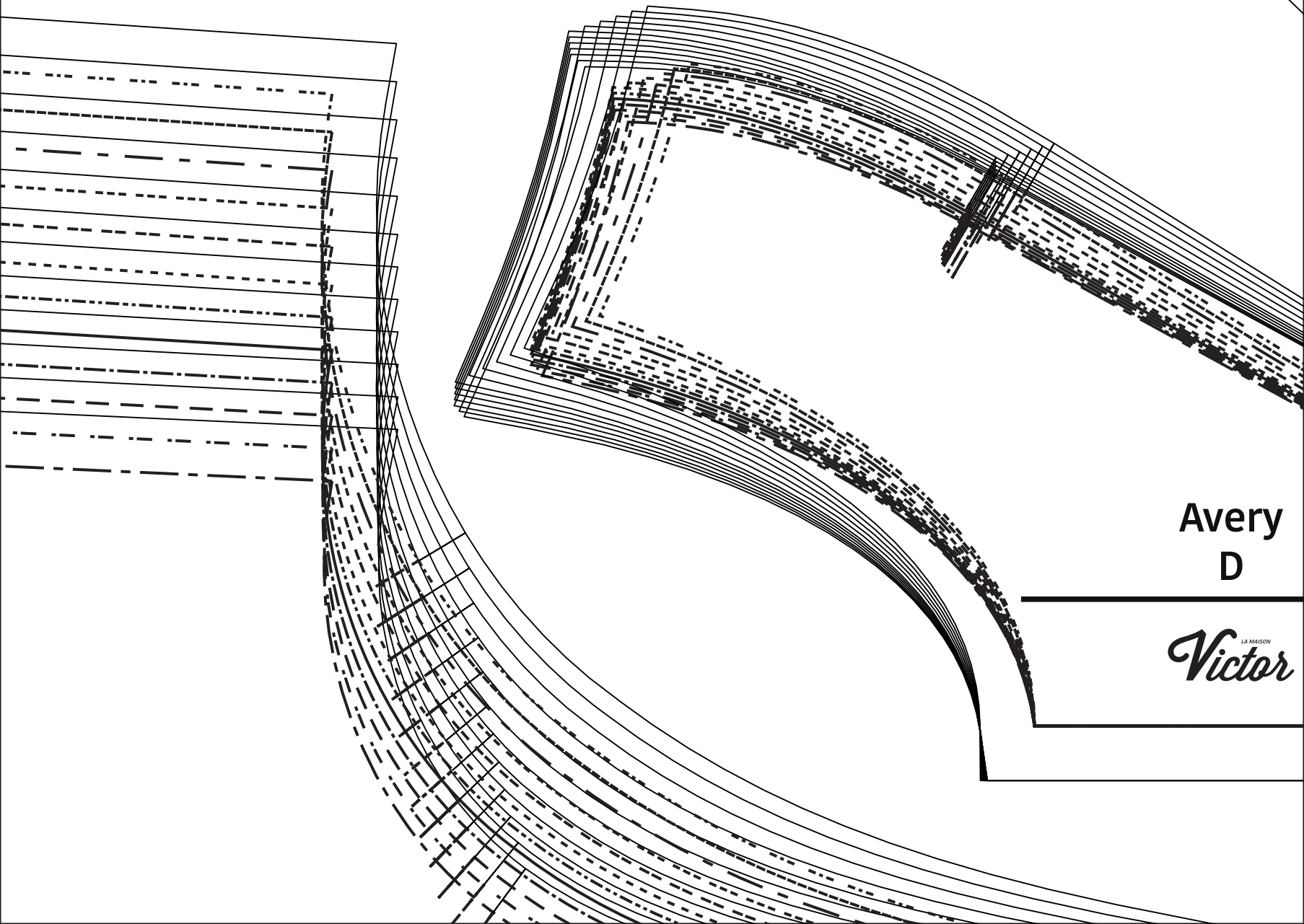

Avery
D

LA MAISON
Victor

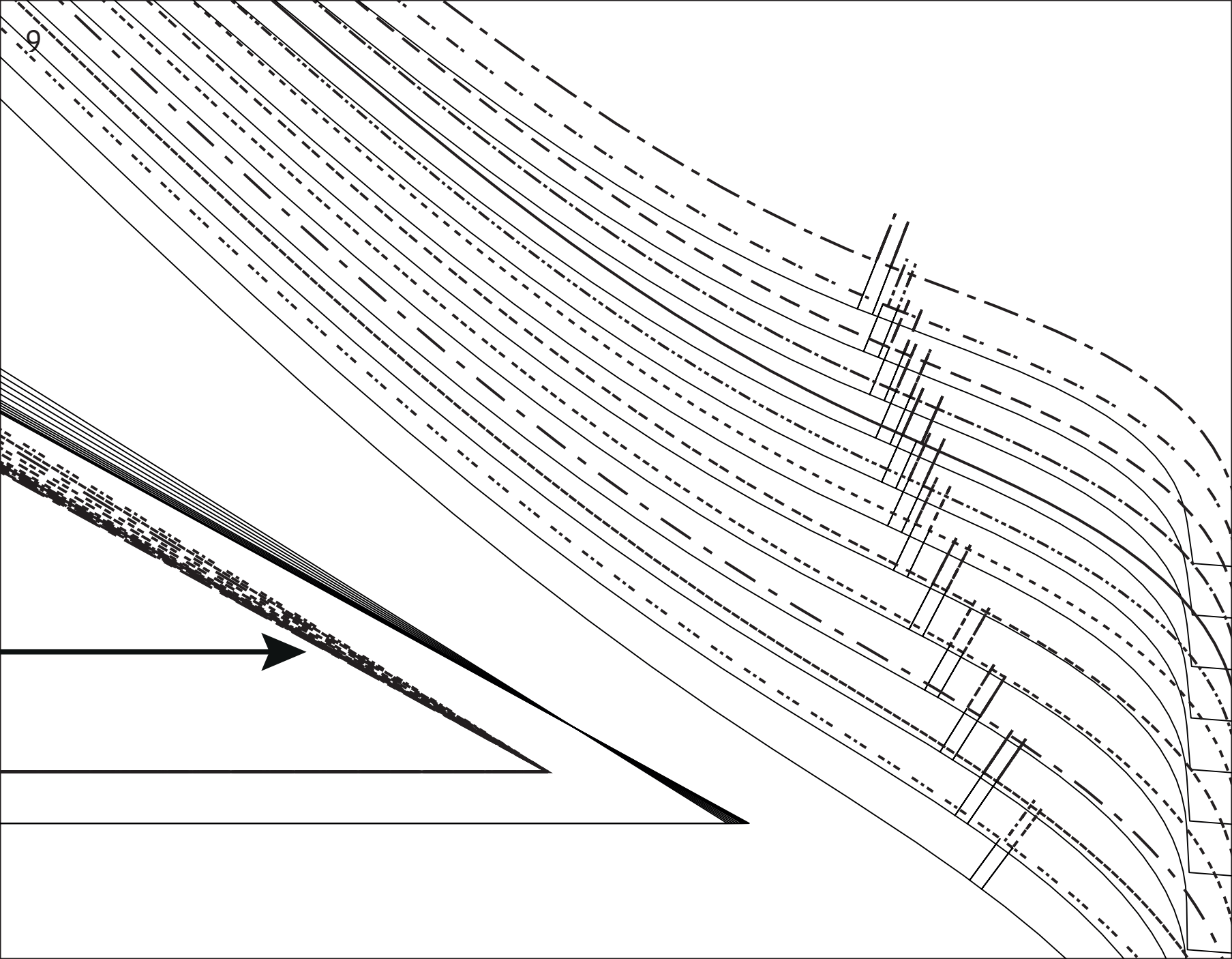

9

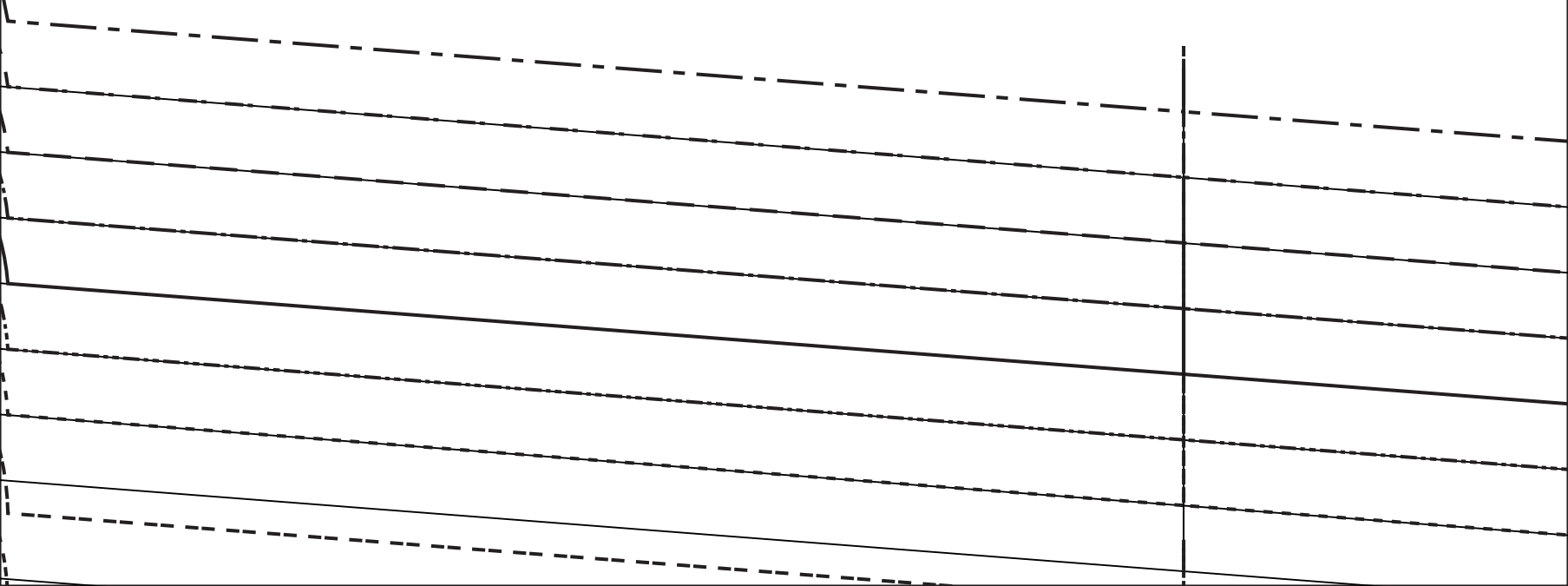

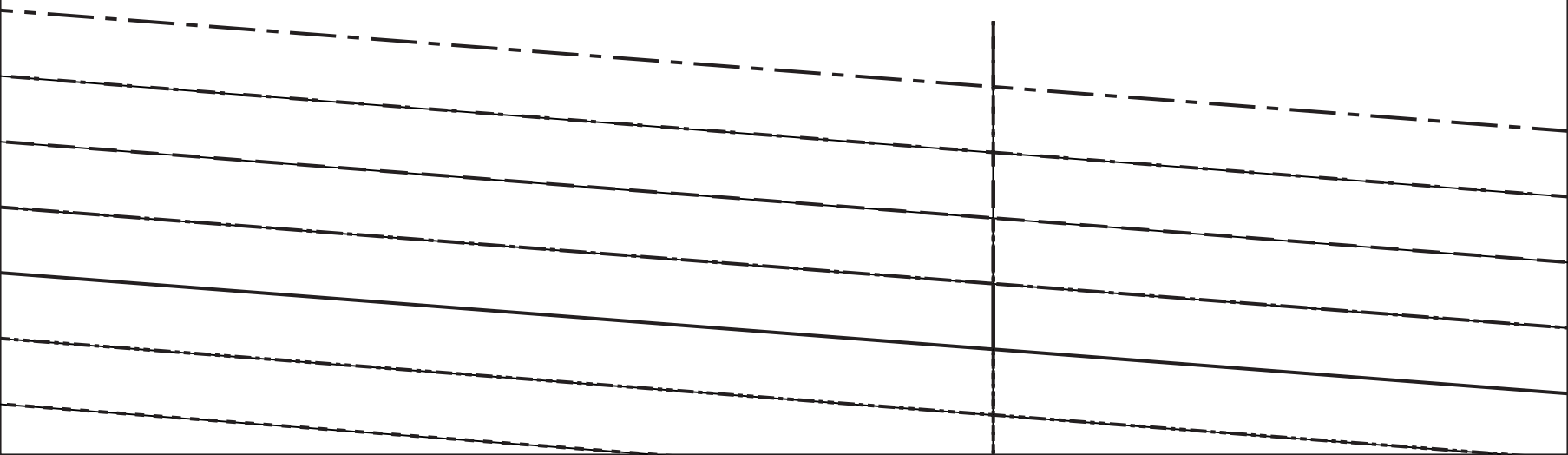

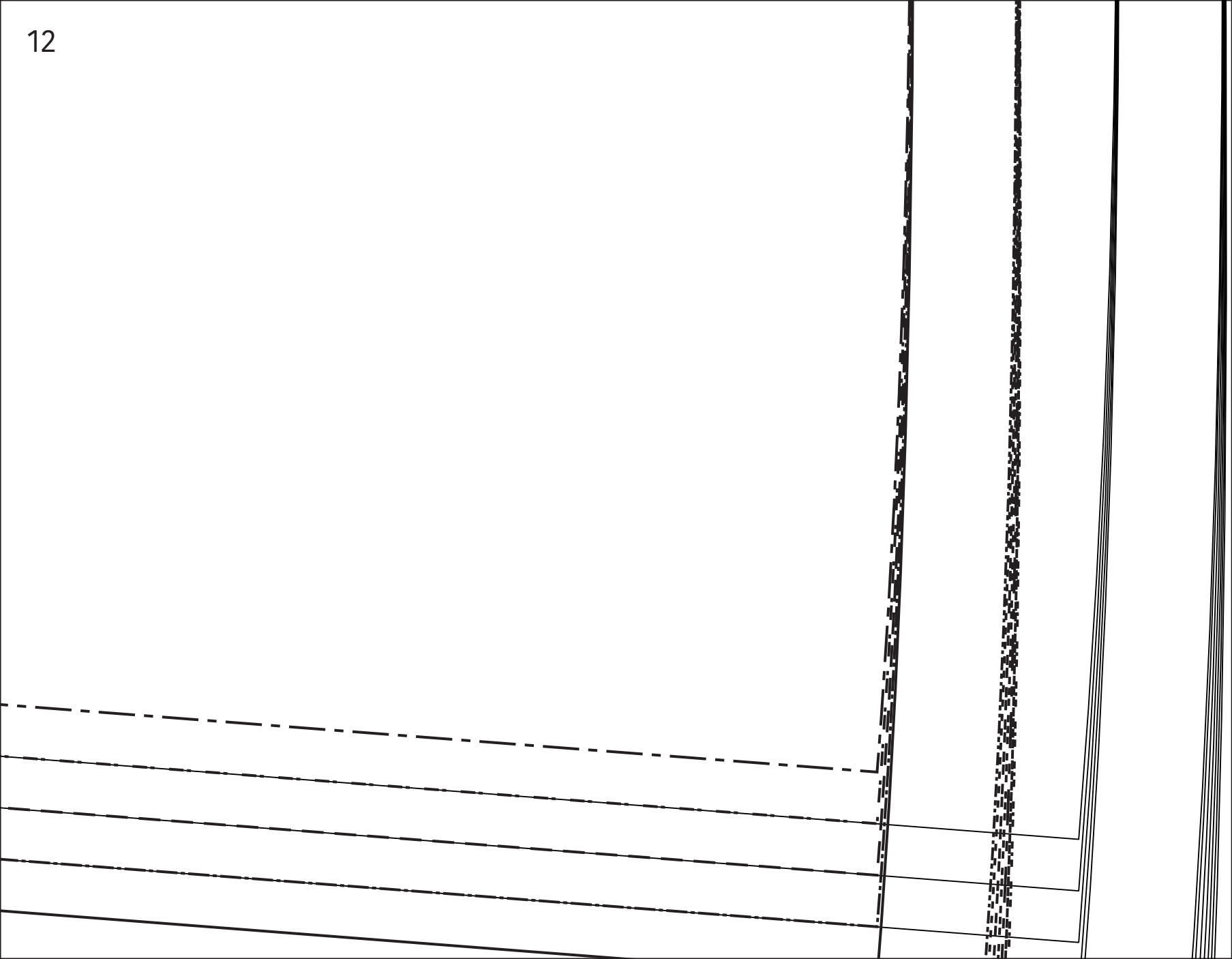

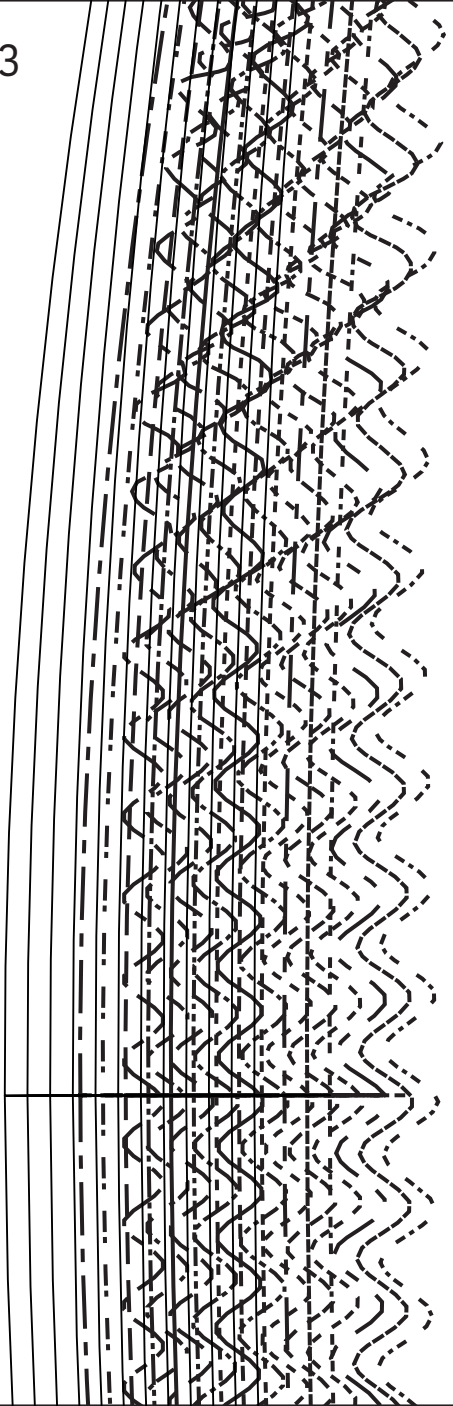

Victor
LA MAISON

Avery -

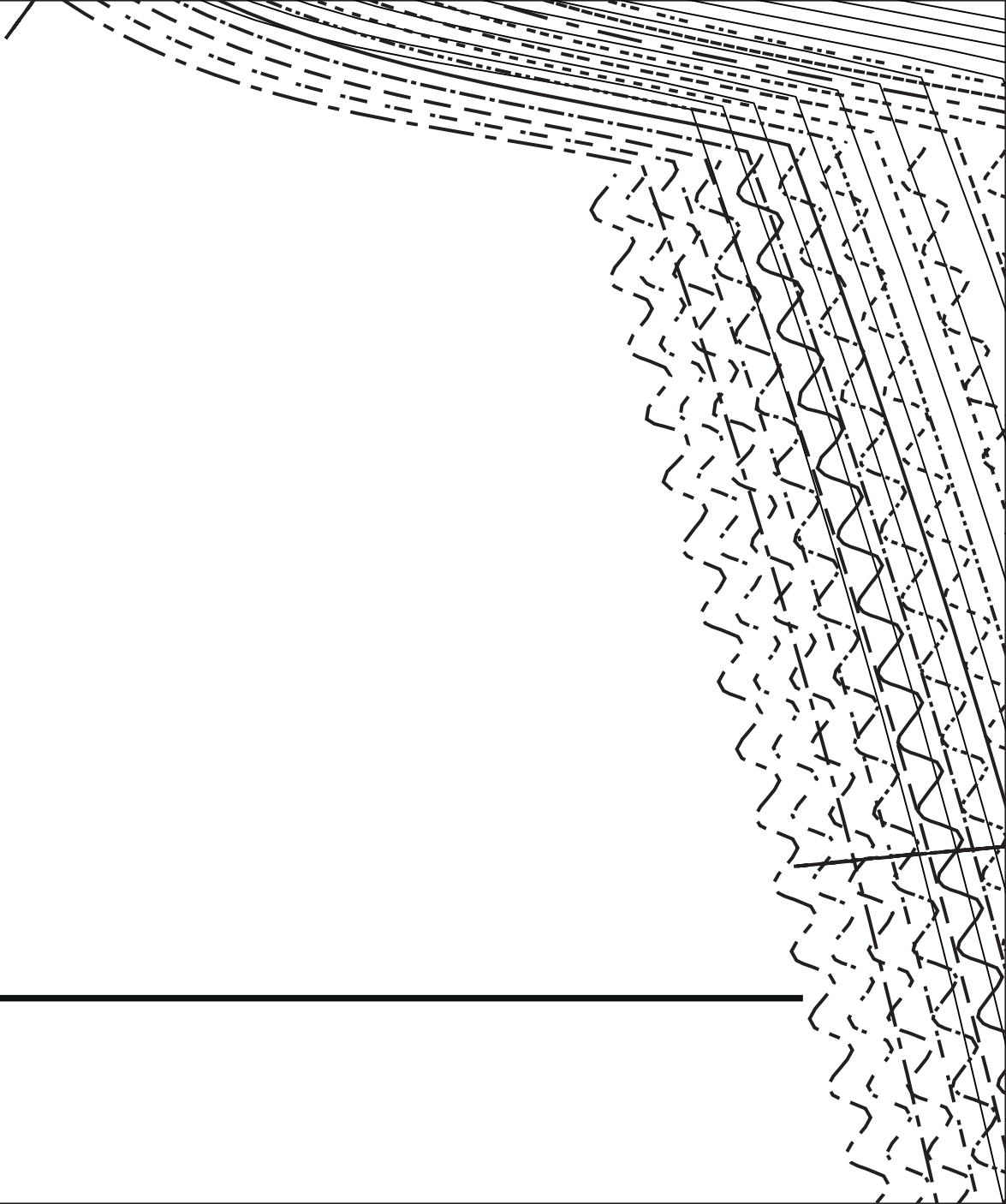

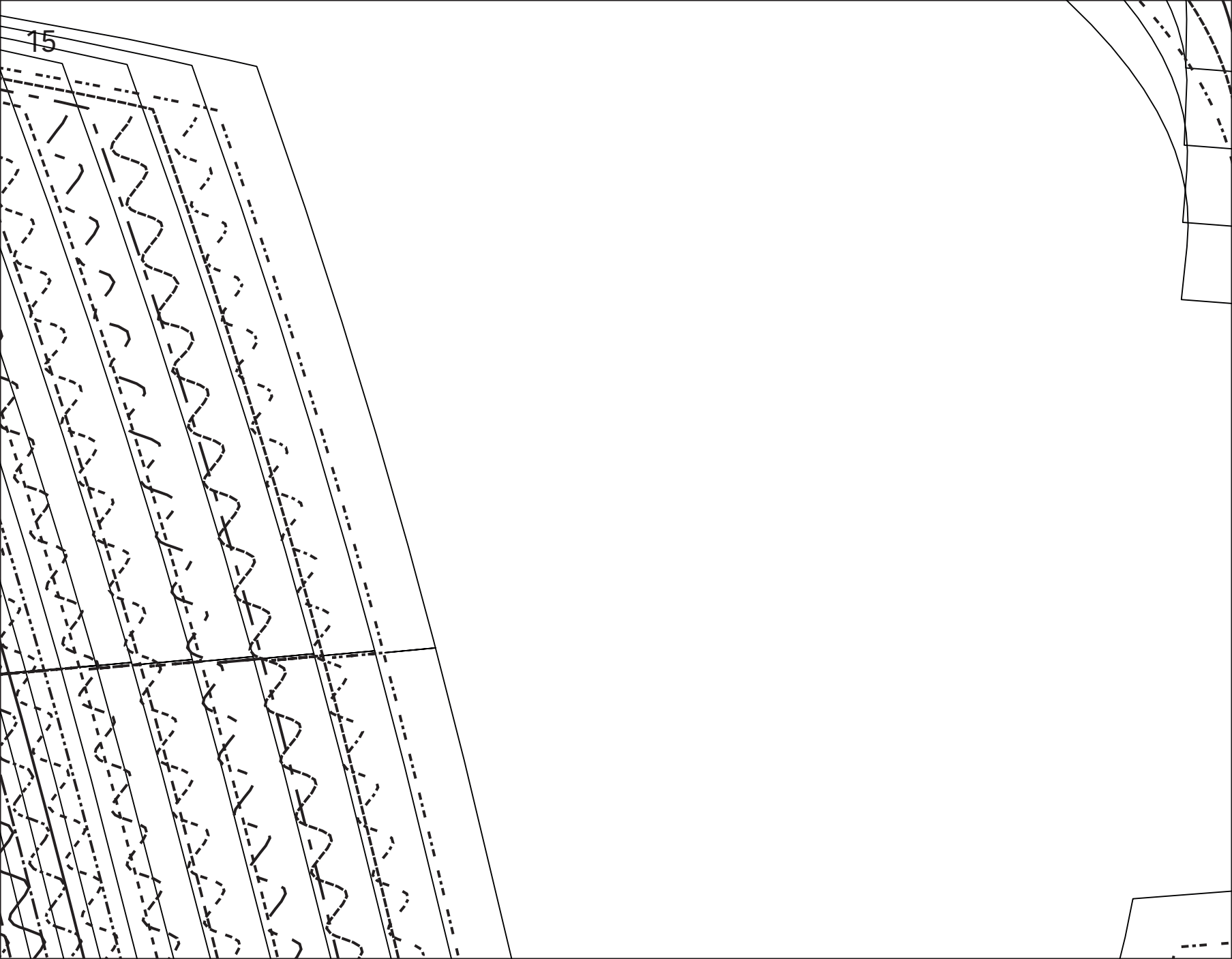

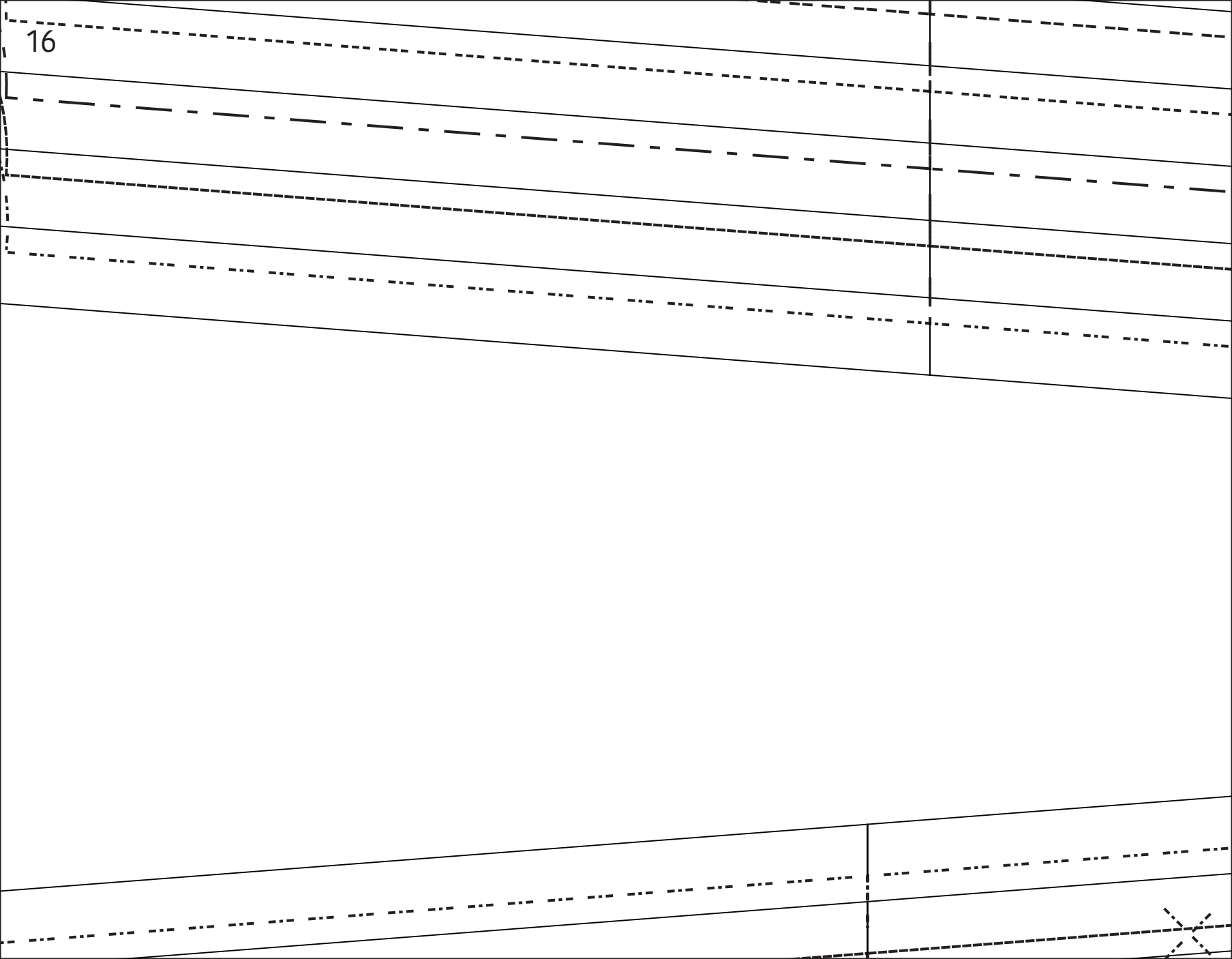

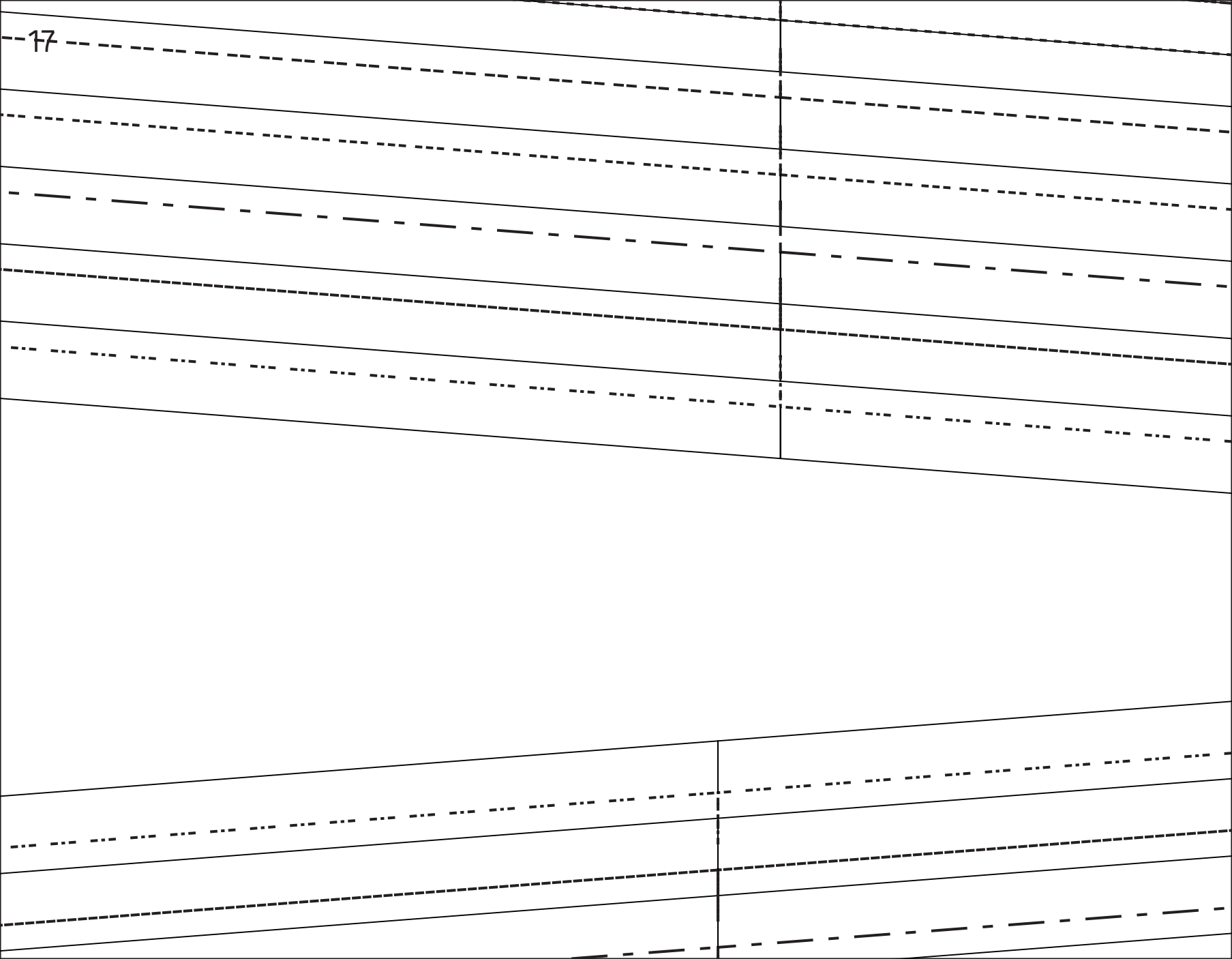

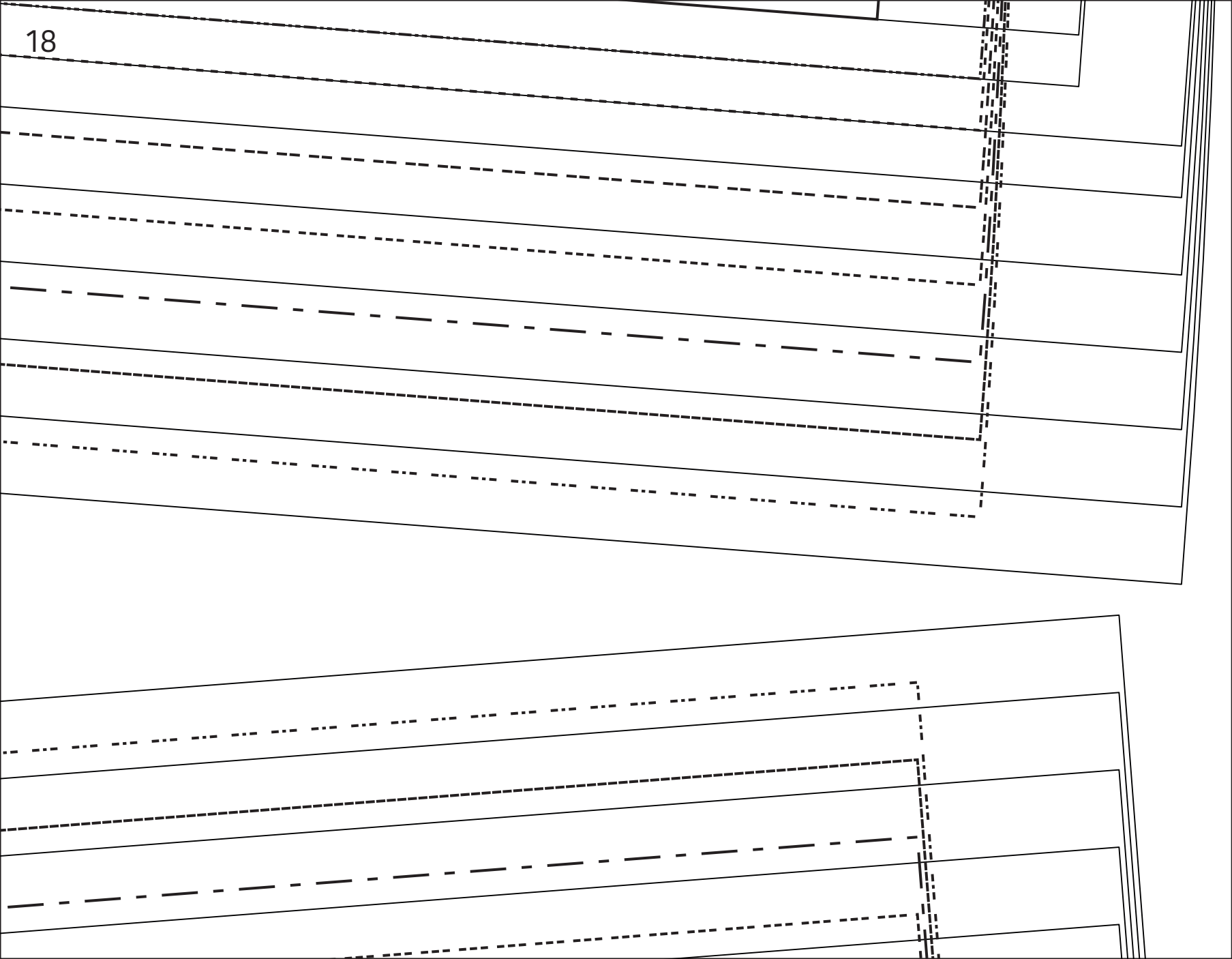

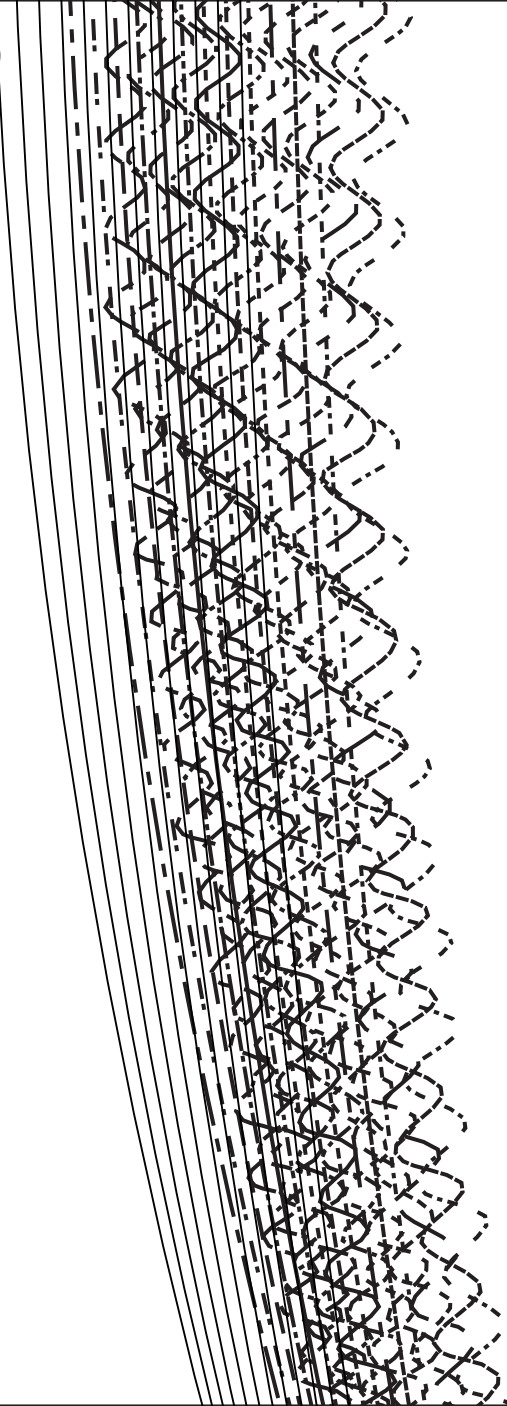

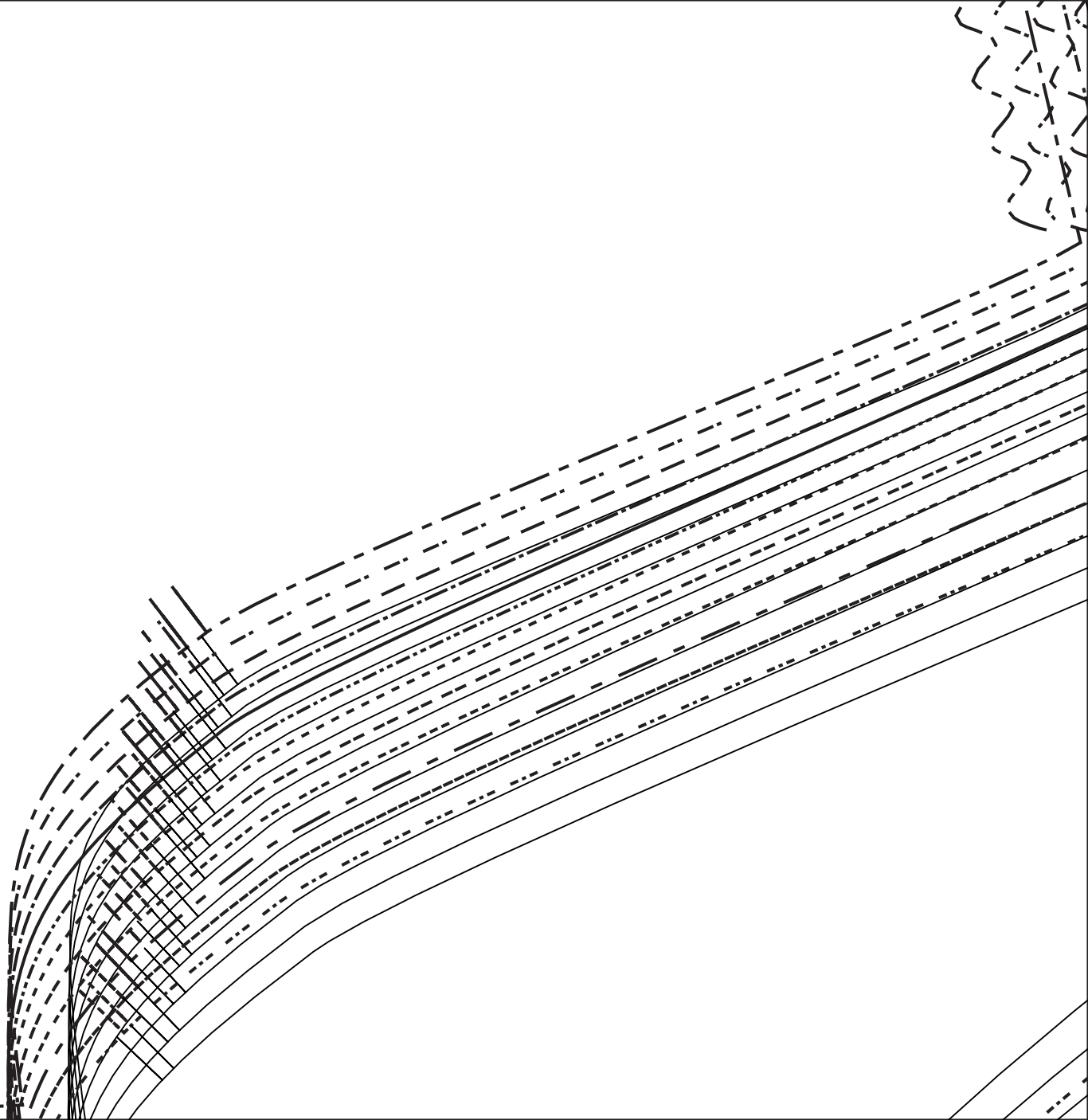

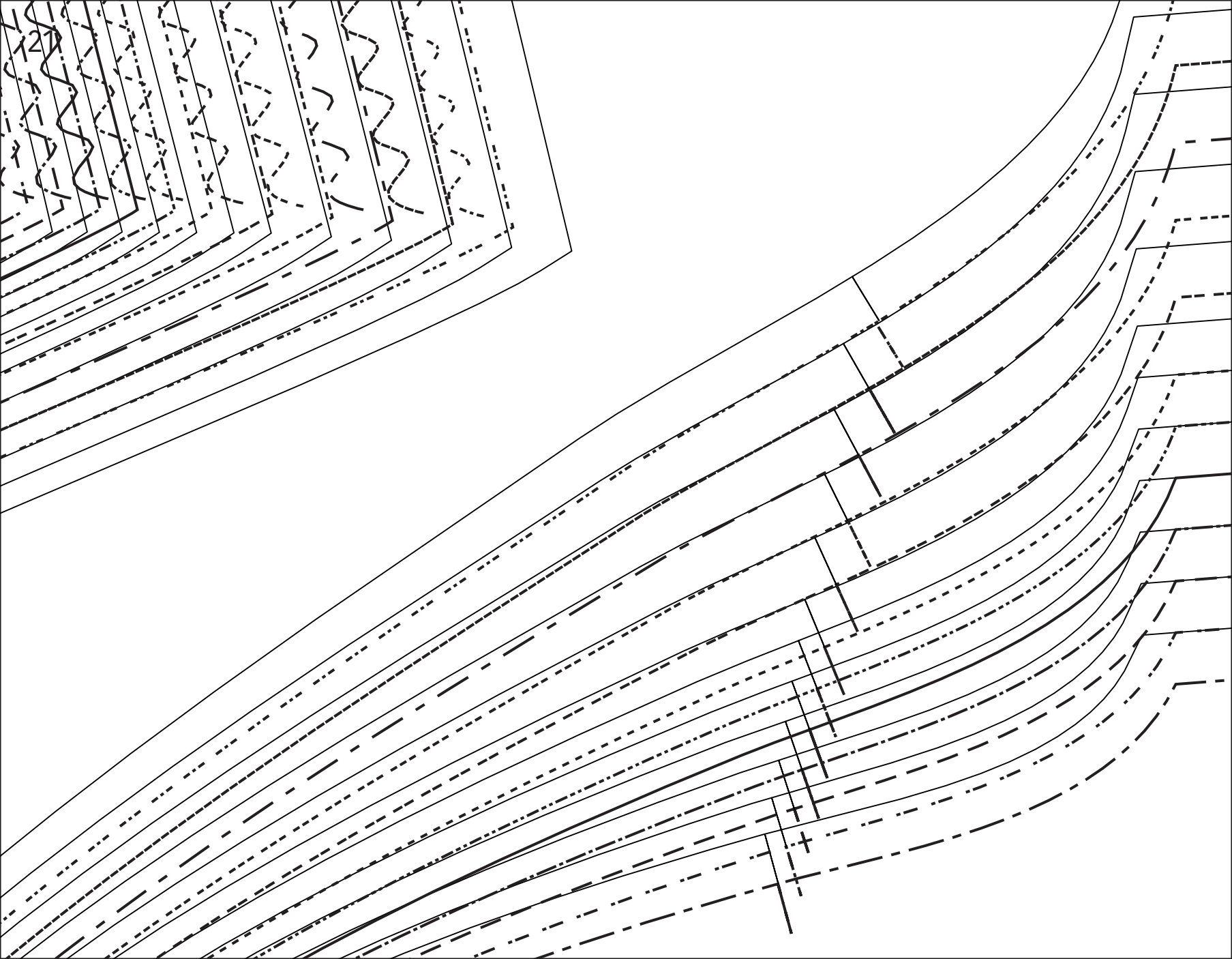

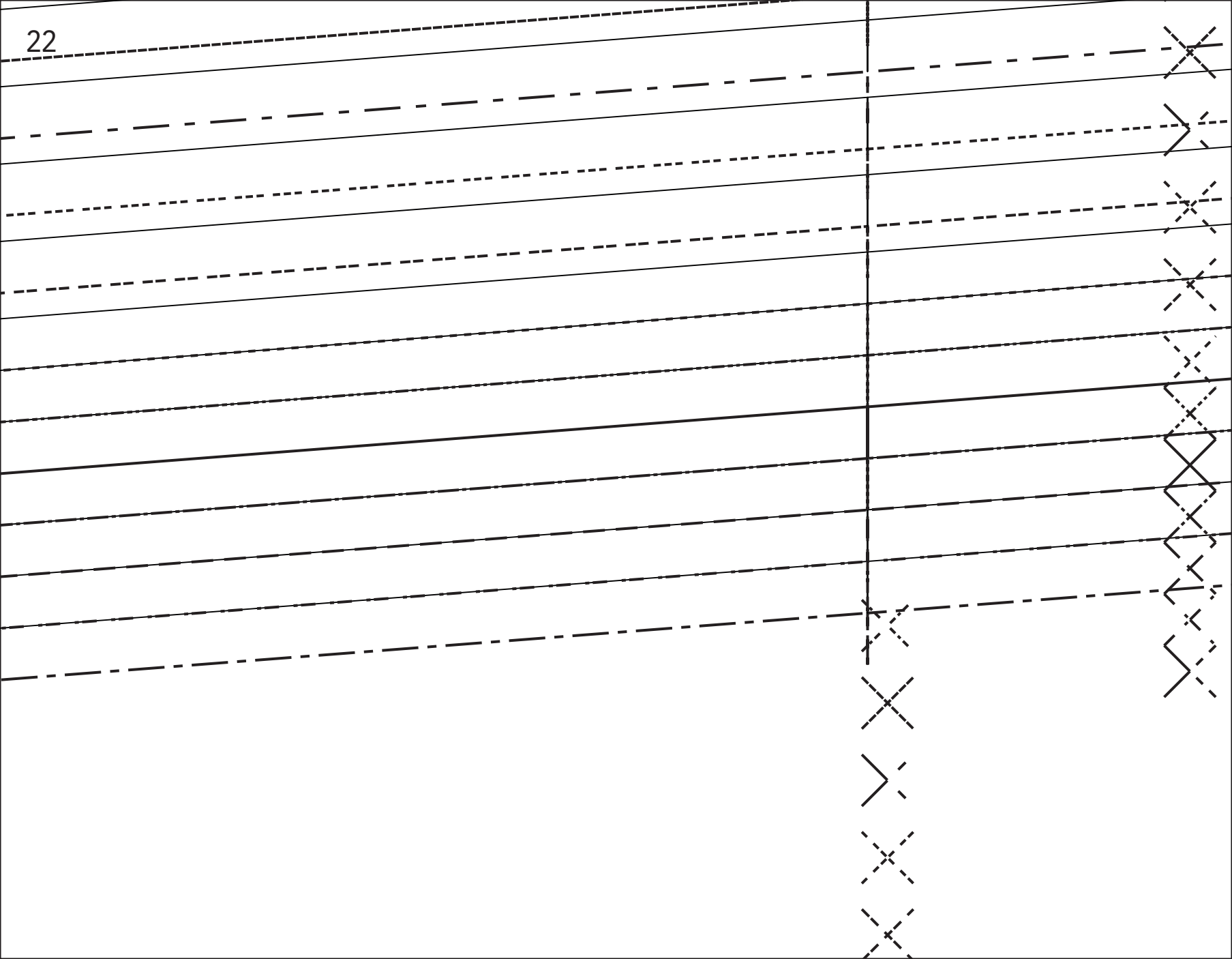

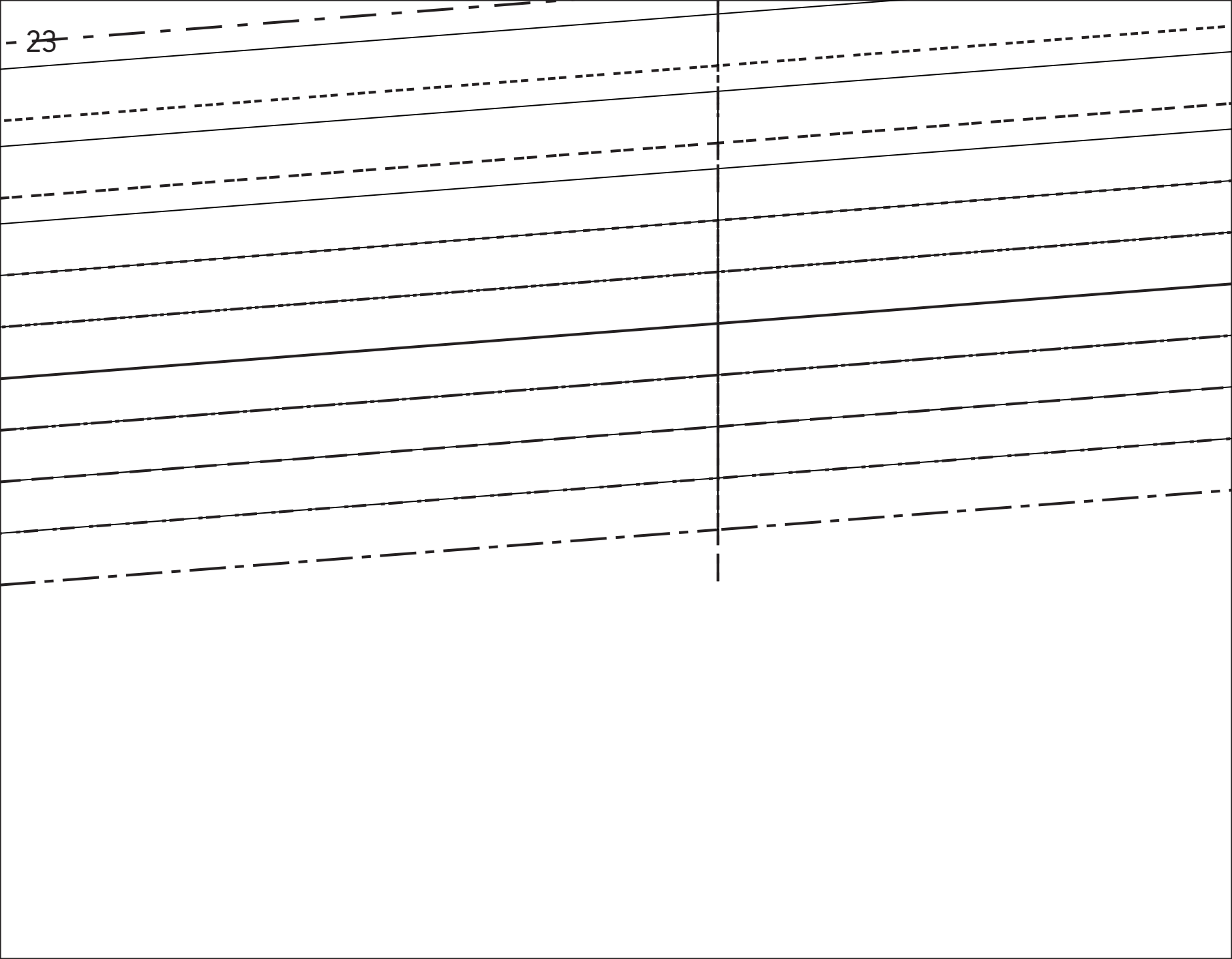

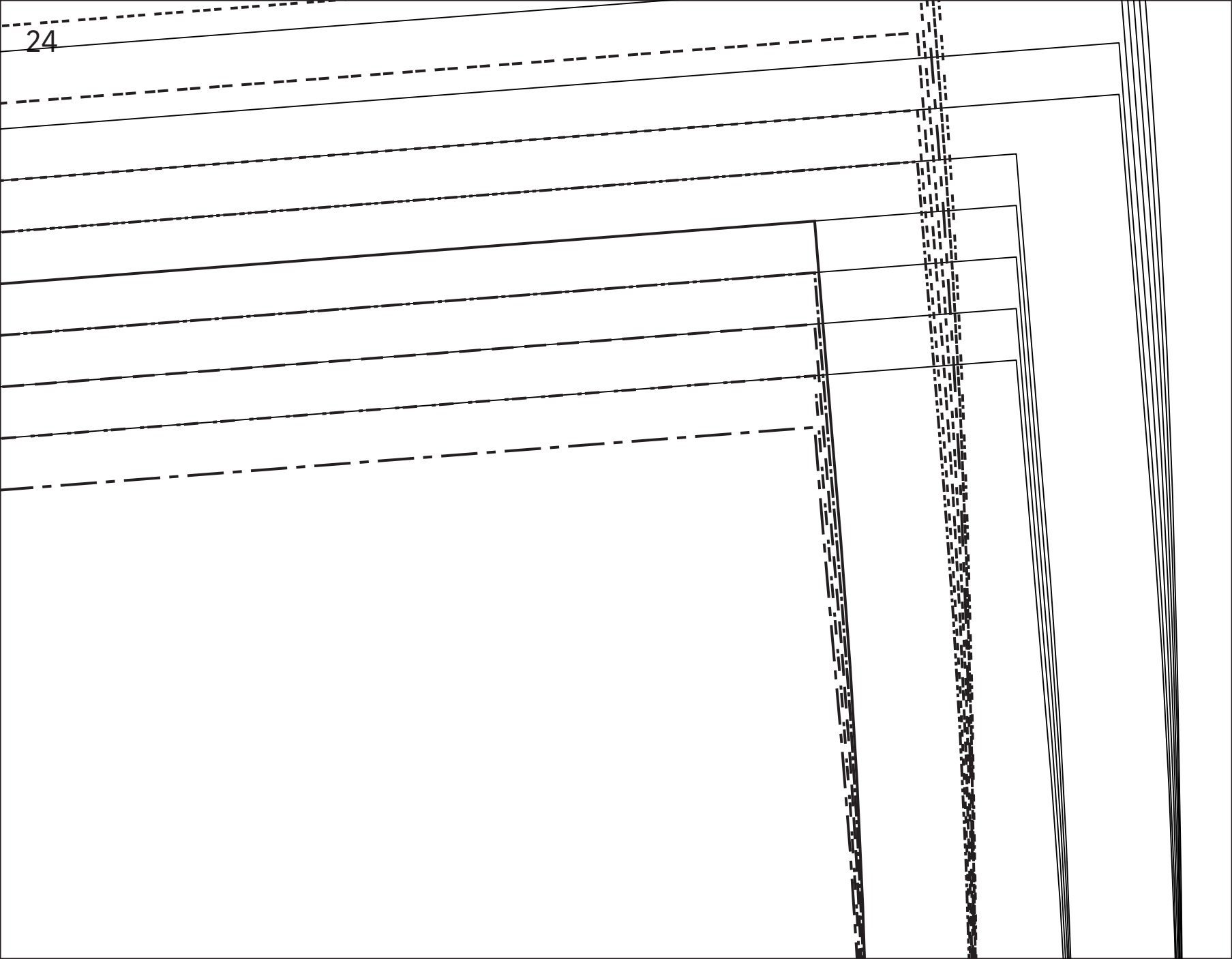

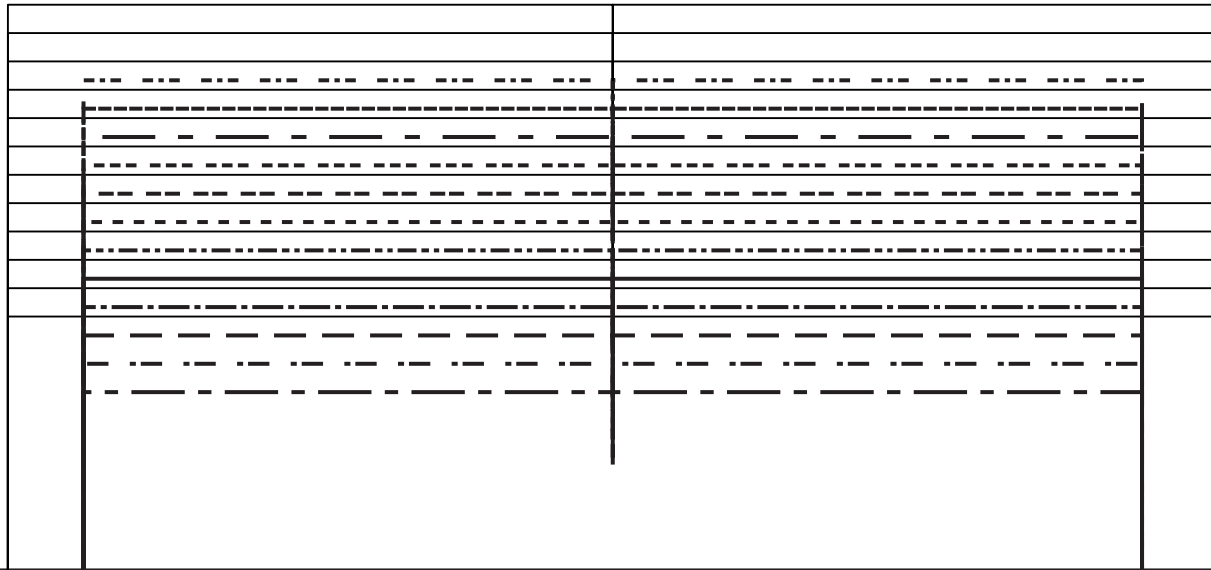
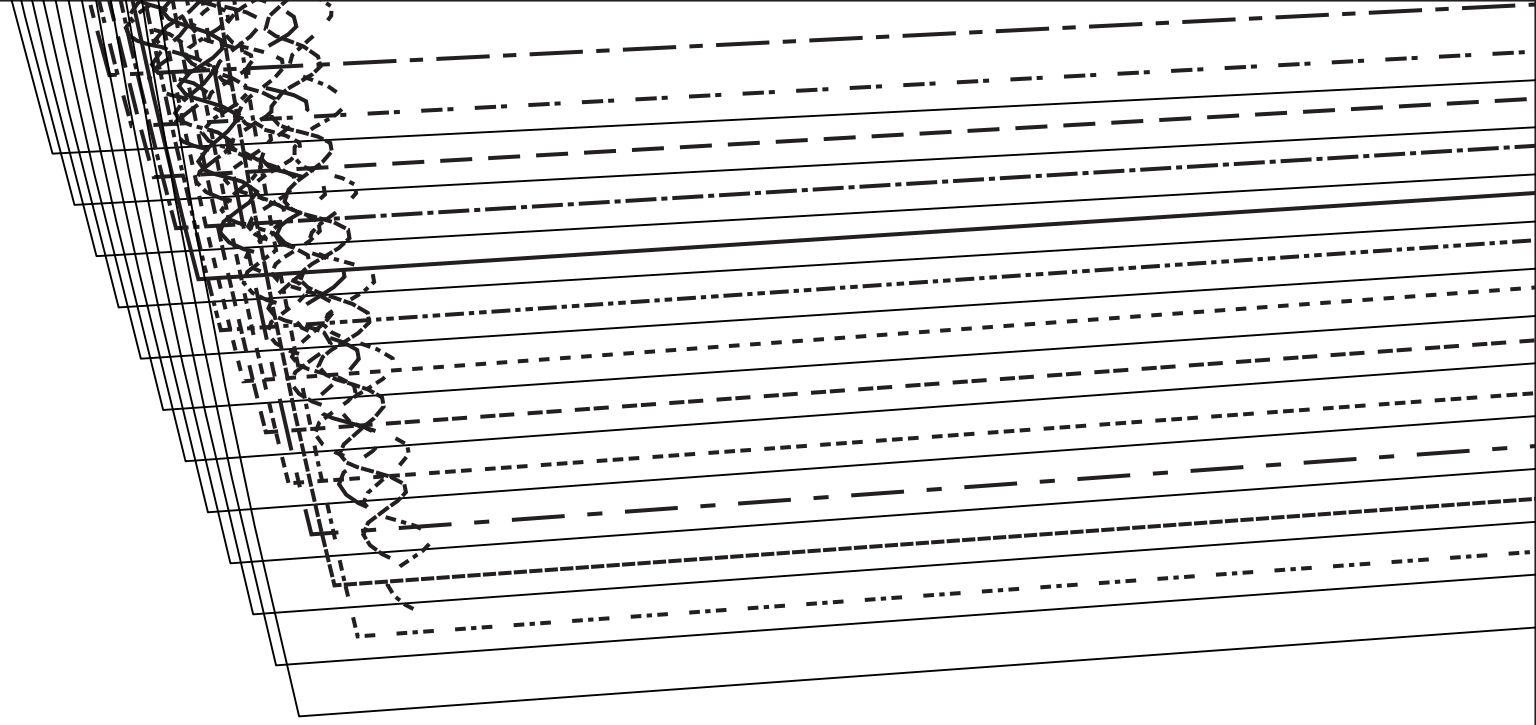

-26

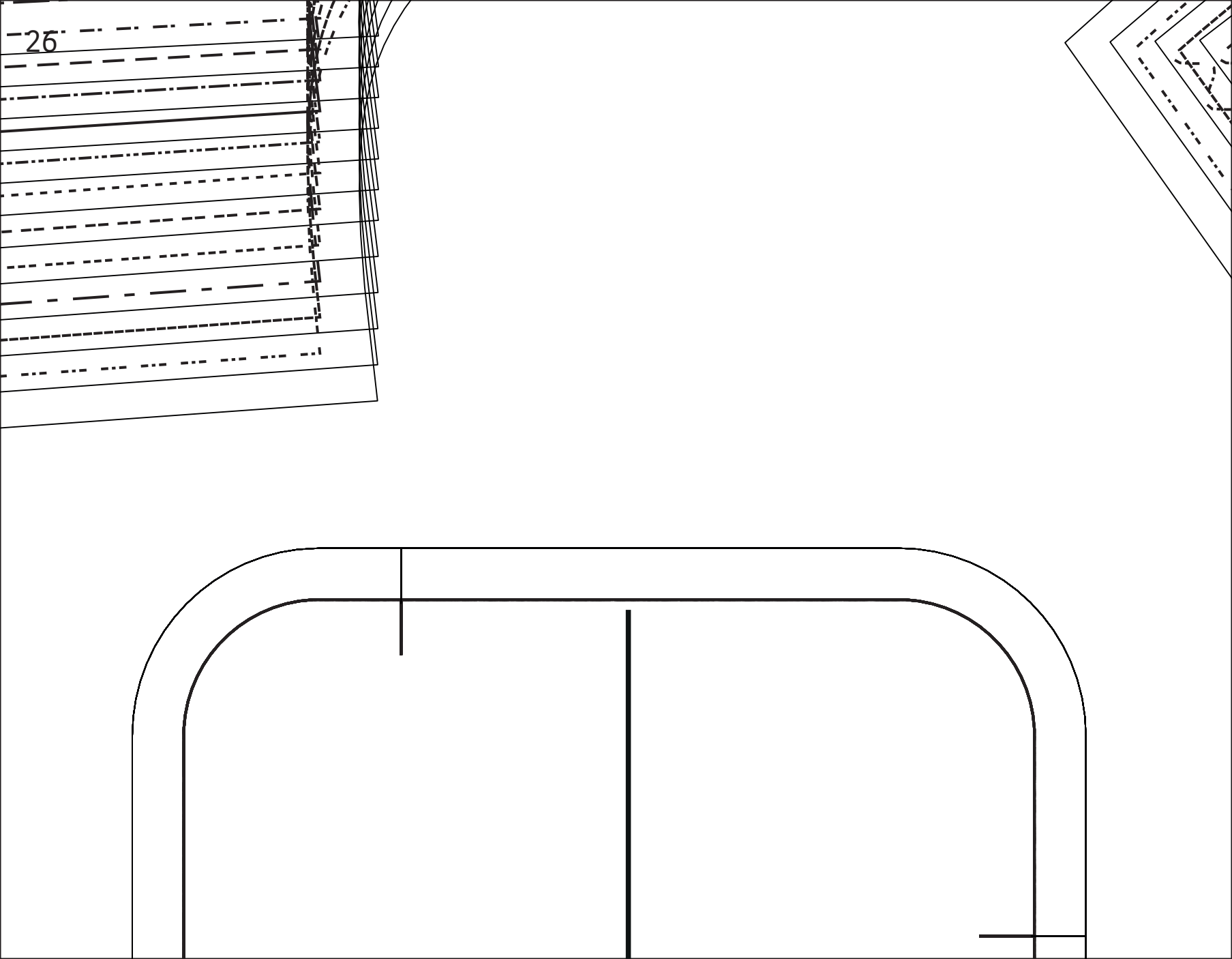

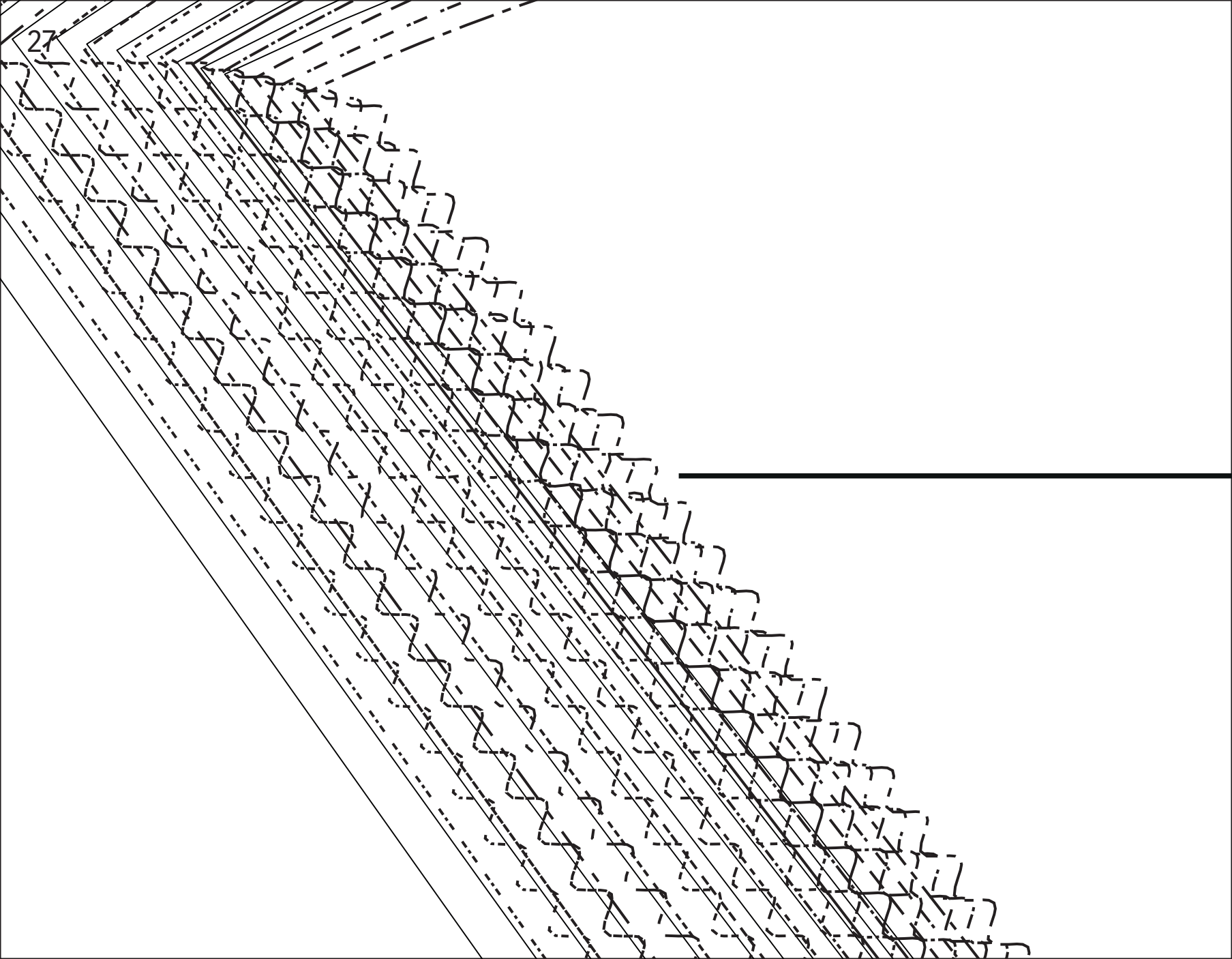

27



Av

o

very - A

LA MAISON
Victor

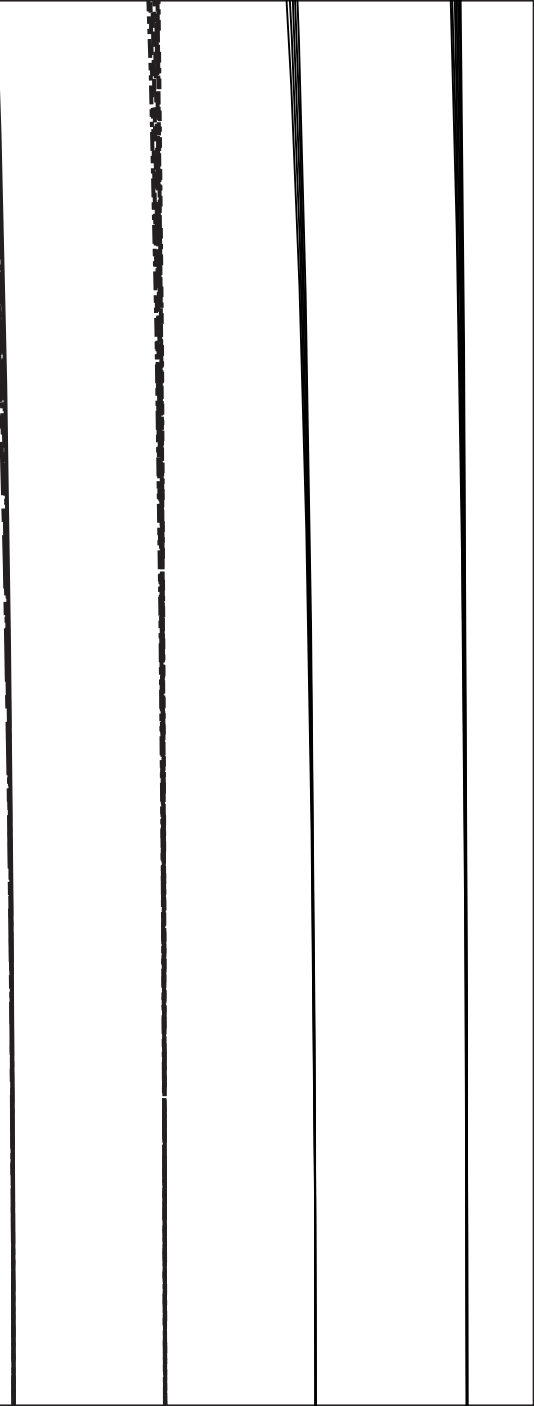

Avery - G



Victor
LA MAISON

Avery - H



Victor
LA MAISON

|||
|||

A

|||
|||

Avery - F

LA MAISON
Victor

