

# Lubette

## Broek / Pantalon / Trousers

### Maten / Tailles / Sizes:

-----	34
-----	36
-----	38
-----	40
-----	42
-----	44
-----	46
-----	48
-----	50
-----	52
-----	54
-----	56

### Patroondelen / Pièces du patron / Pattern pieces:

- A** voorpand / devant / front panel
- B** rugpand / dos / back panel
- C** pas RP / empiècement DS / yoke BP
- D** tailleband LVP / ceinture DVG /  
waistband LFP
- E** tailleband RVP / ceinture DVD /  
waistband RFP
- F** tailleband RP / ceinture DS /  
waistband BP
- G** gulpstuk / braguette / fly
- H** zak VP / poche DV / pocket FP
- I** zak RP / poche DS / pocket BP

### Patroonschema / Schéma du Patron / Pattern Diagram / Übersichtsplan zum Zusammenkleben

1	2	3	4	5	6
7	8	9	10	11	12
13	14	15	16	17	18
19	20	21	22	23	24
25	26	27	28		

### Controlevierkant / Carré de controle / Test square / Kontrollquadrat

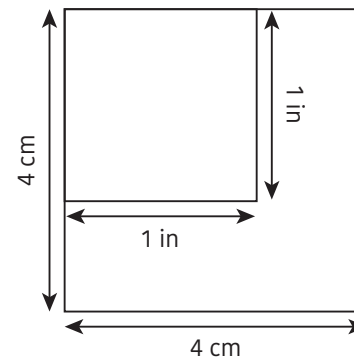

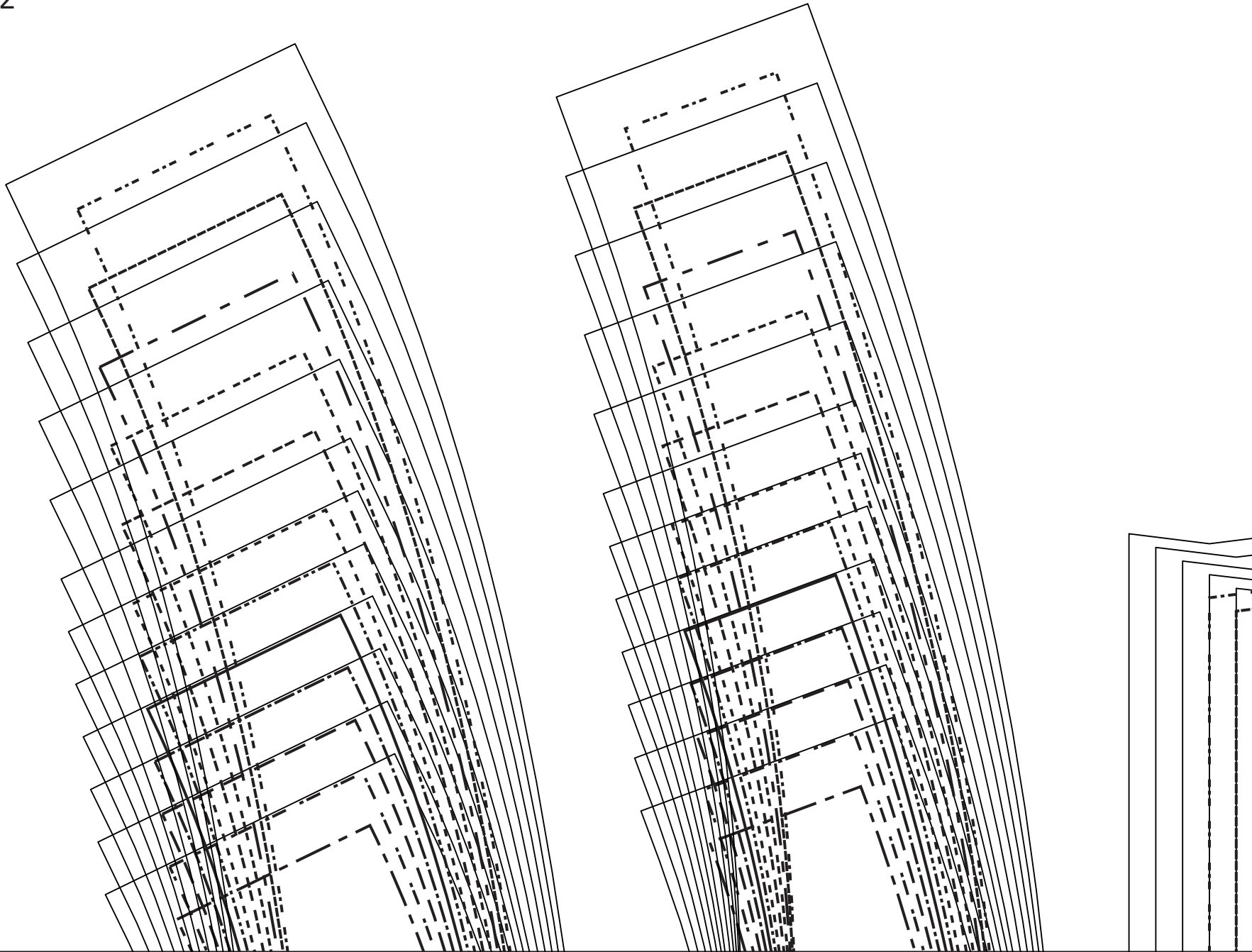

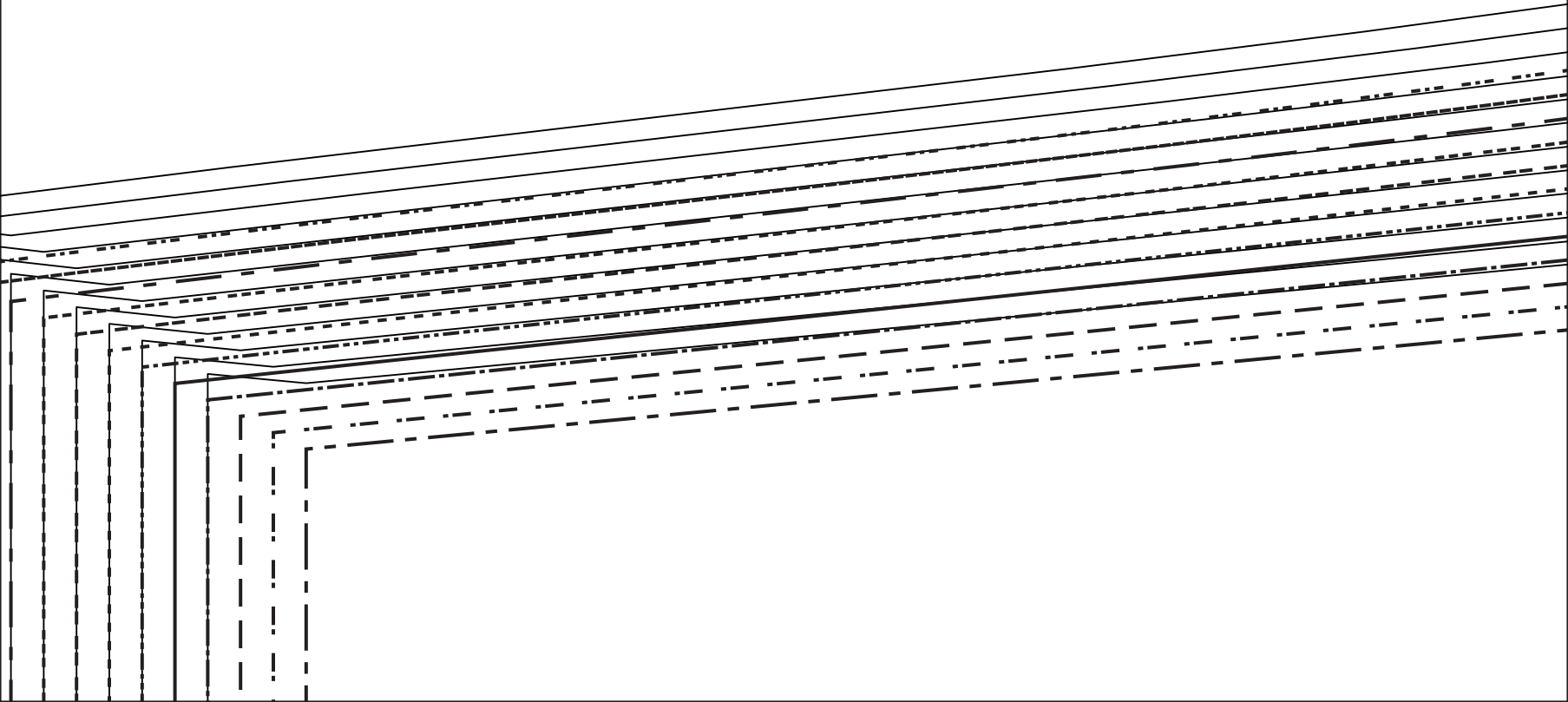

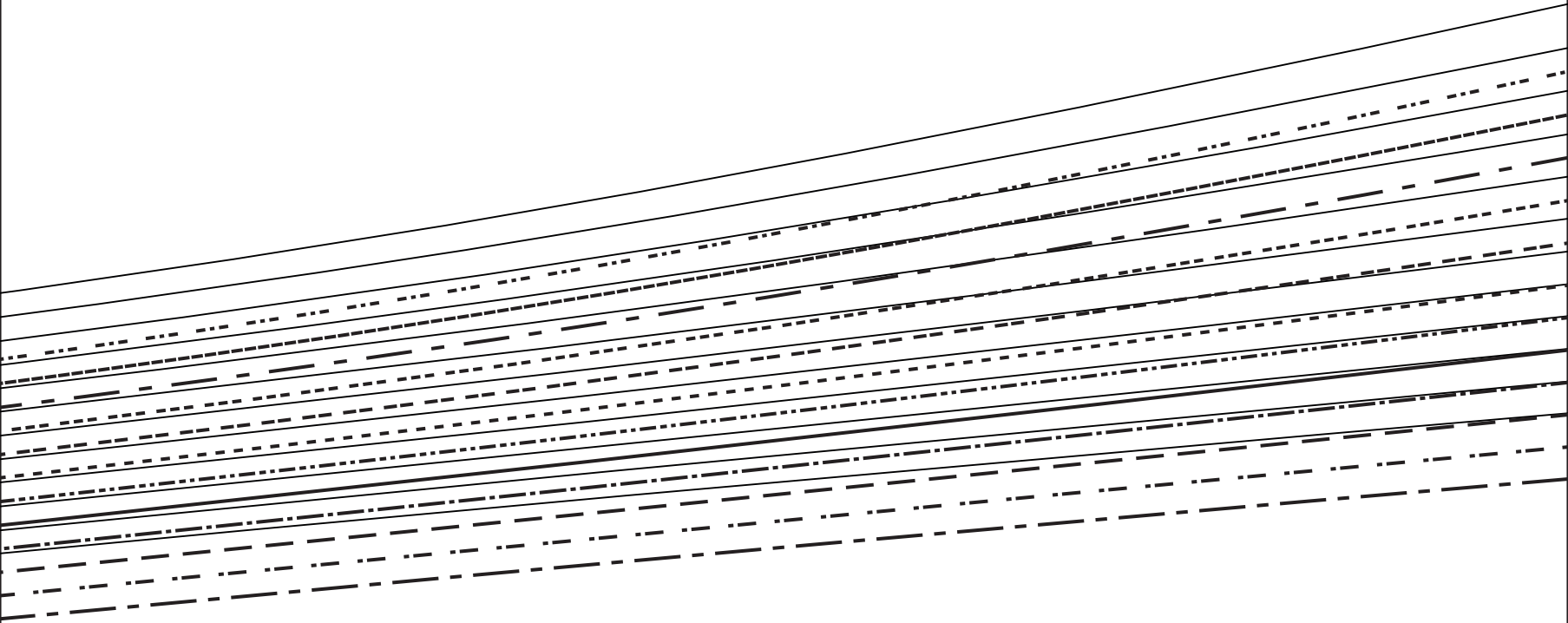

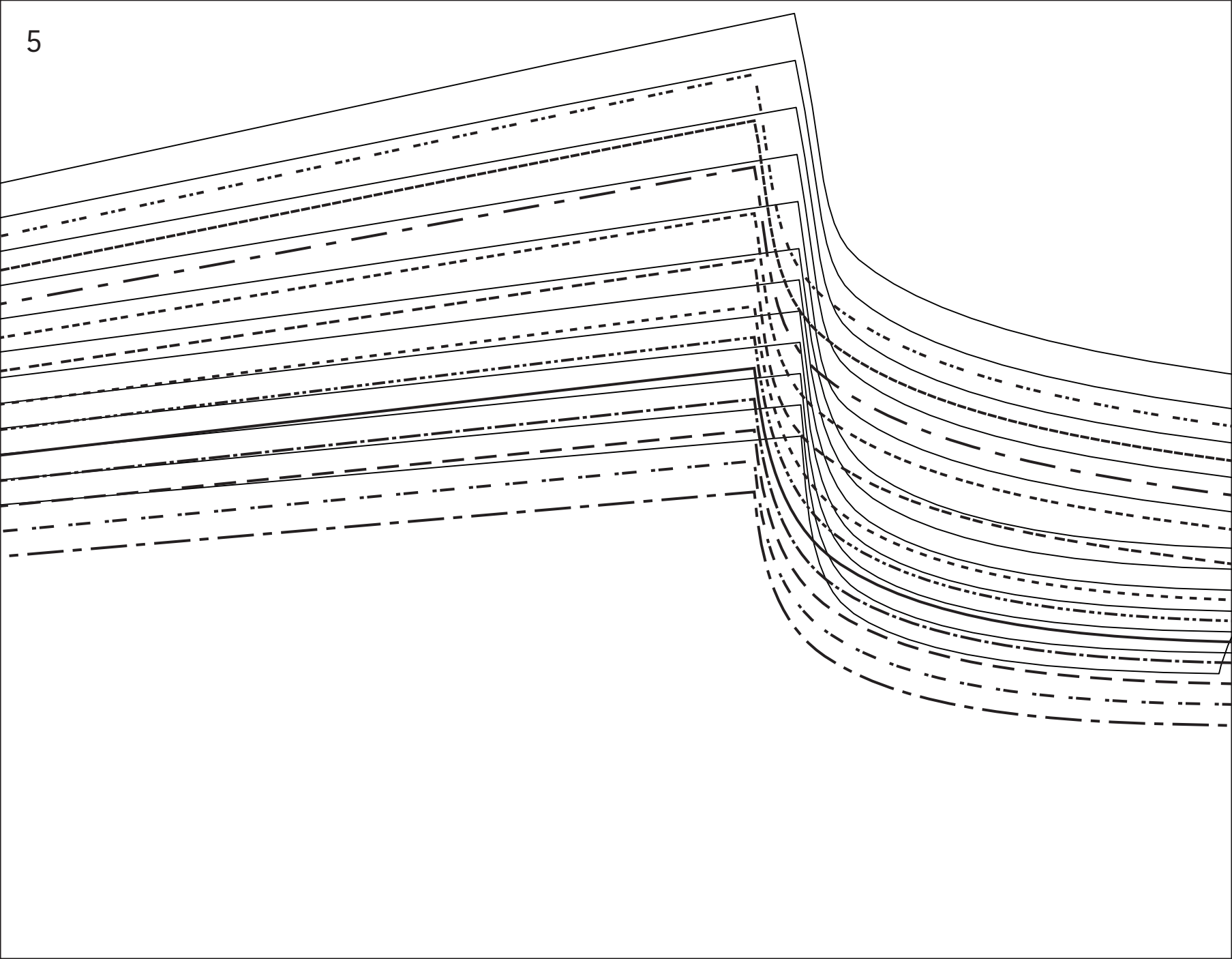

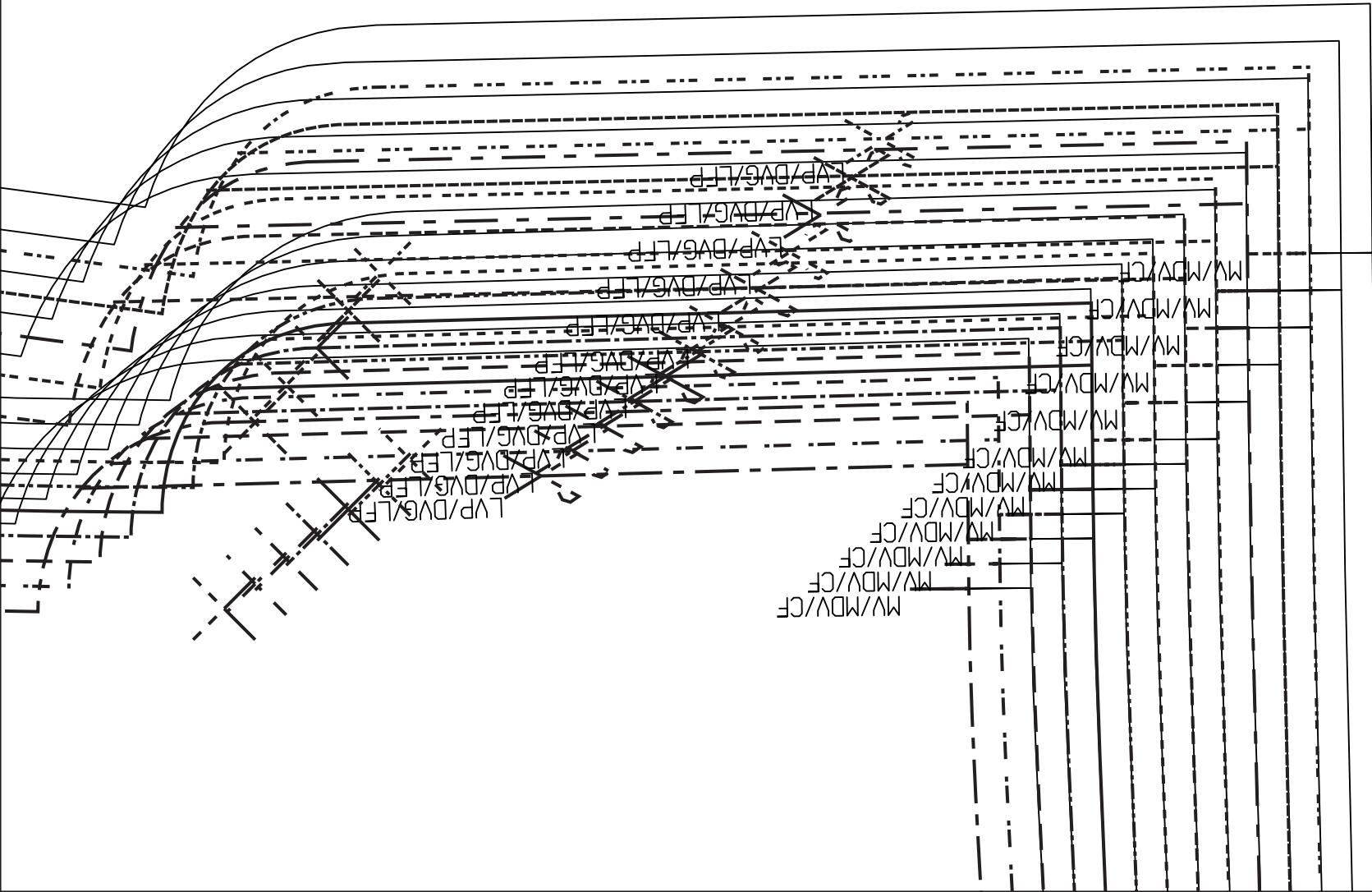

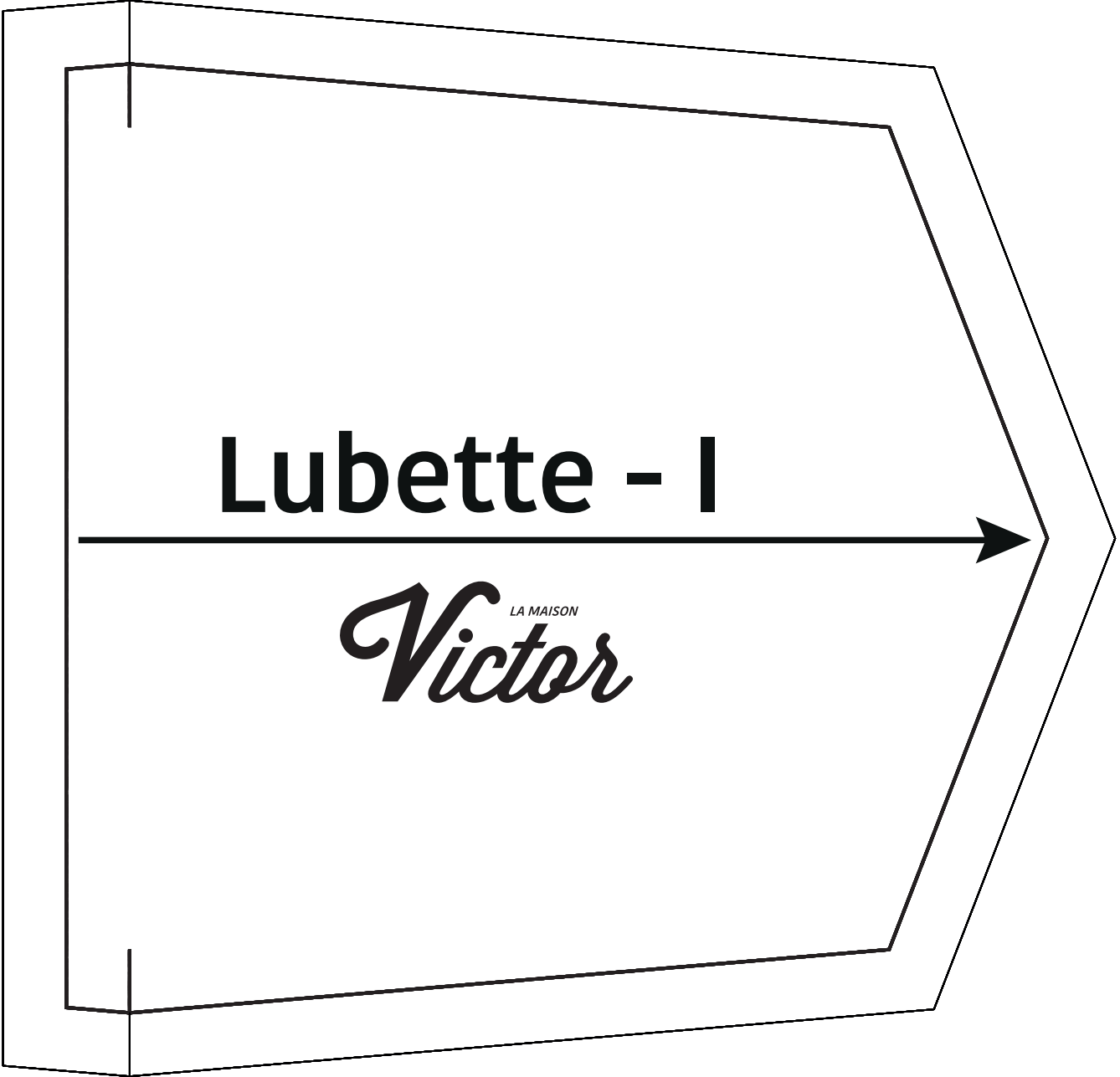

Lubette - I

*Victor*  
LA MAISON

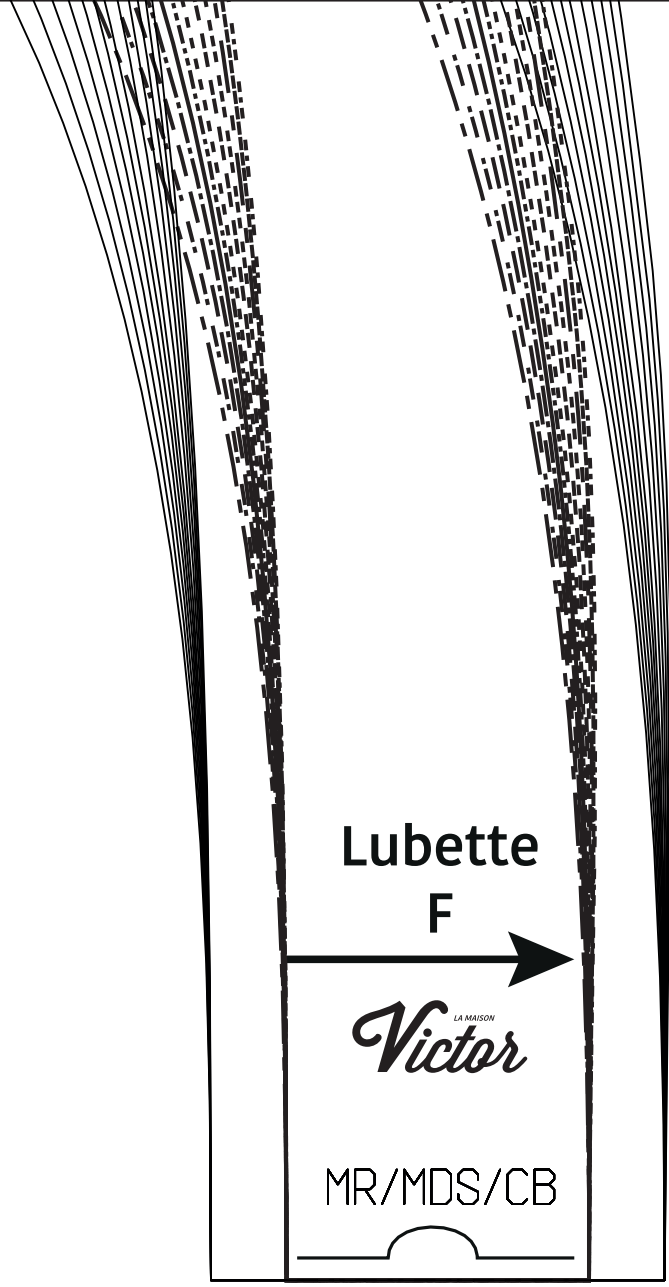



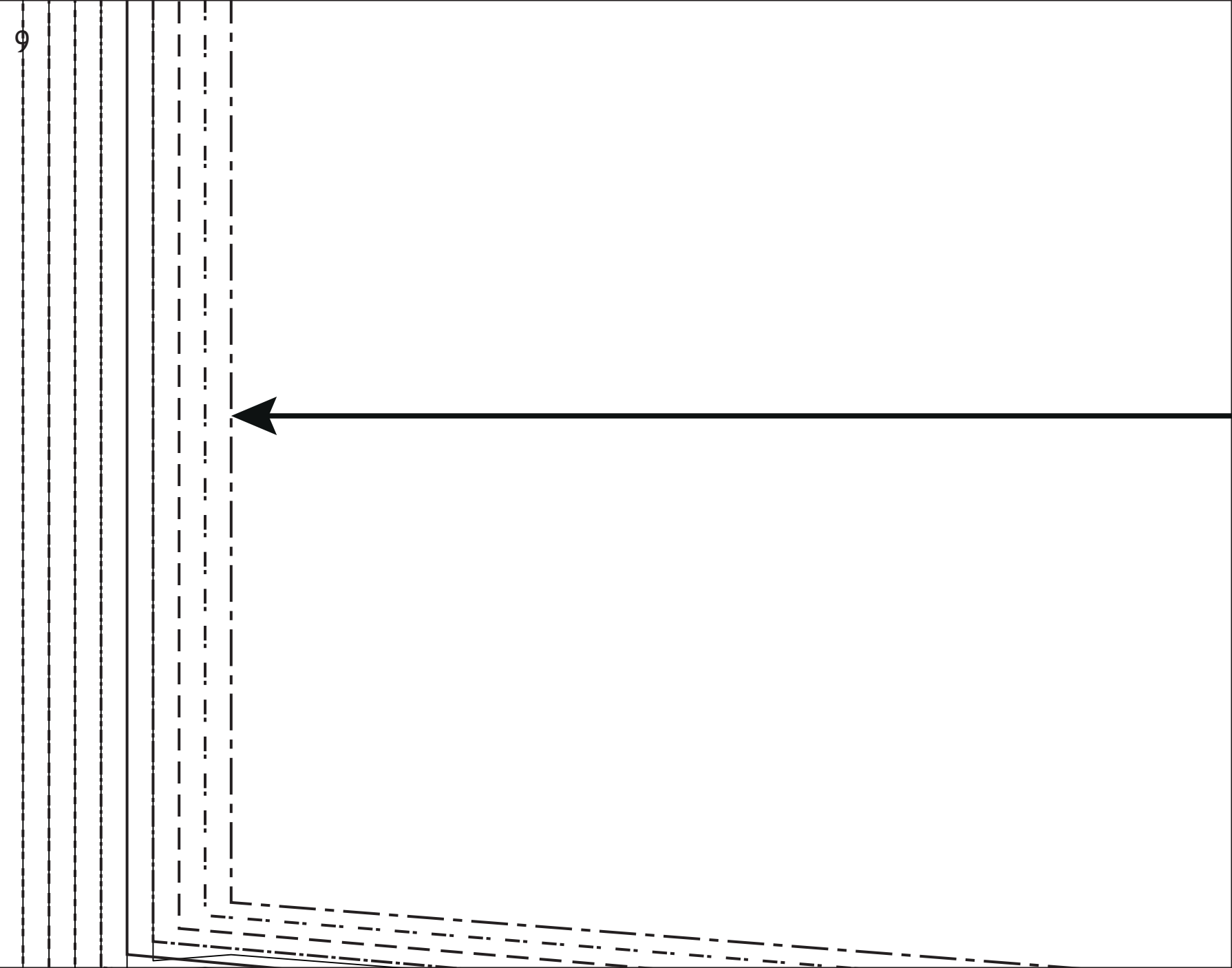

3

A -

*Victor*  
LA MAISON

Lubette

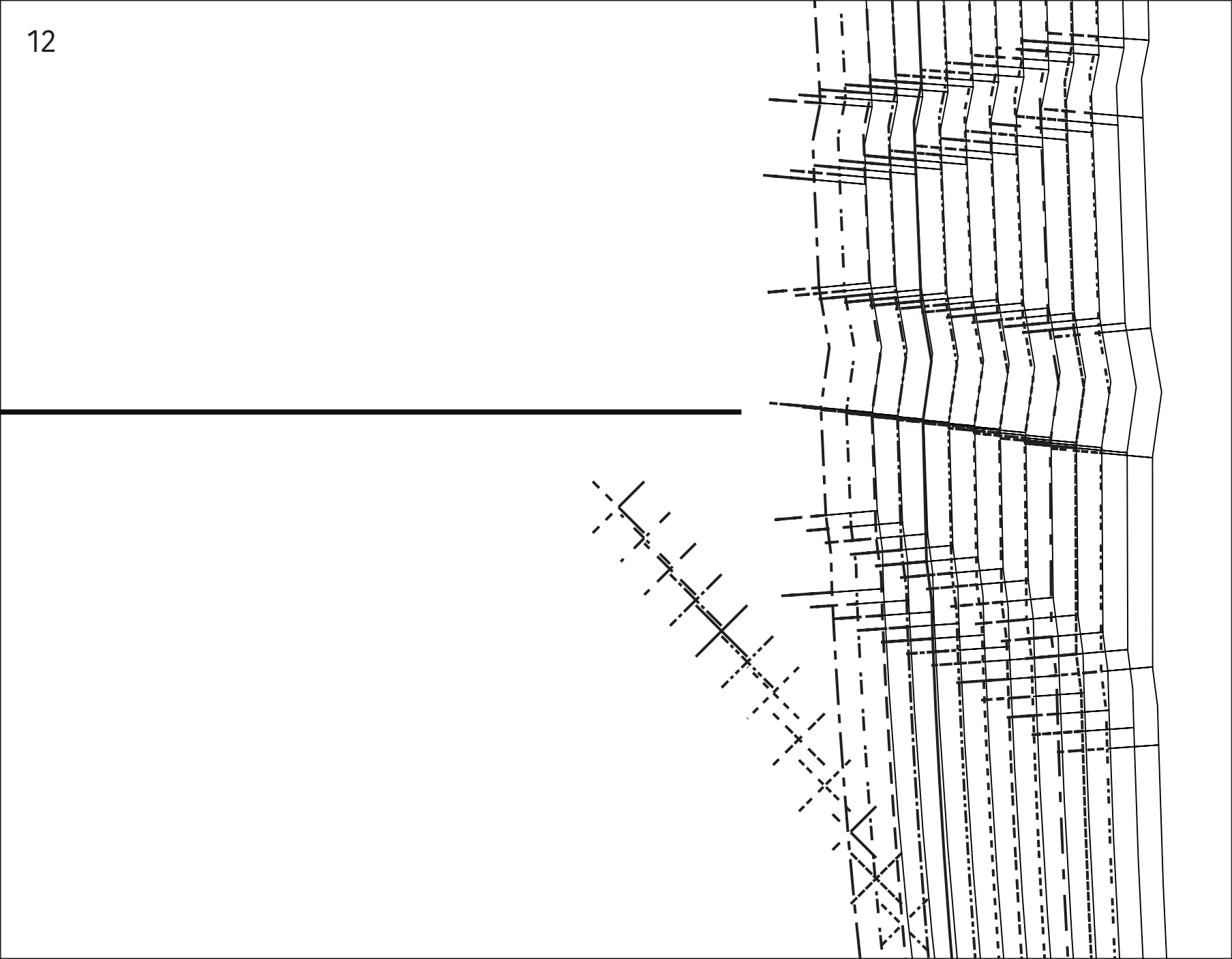

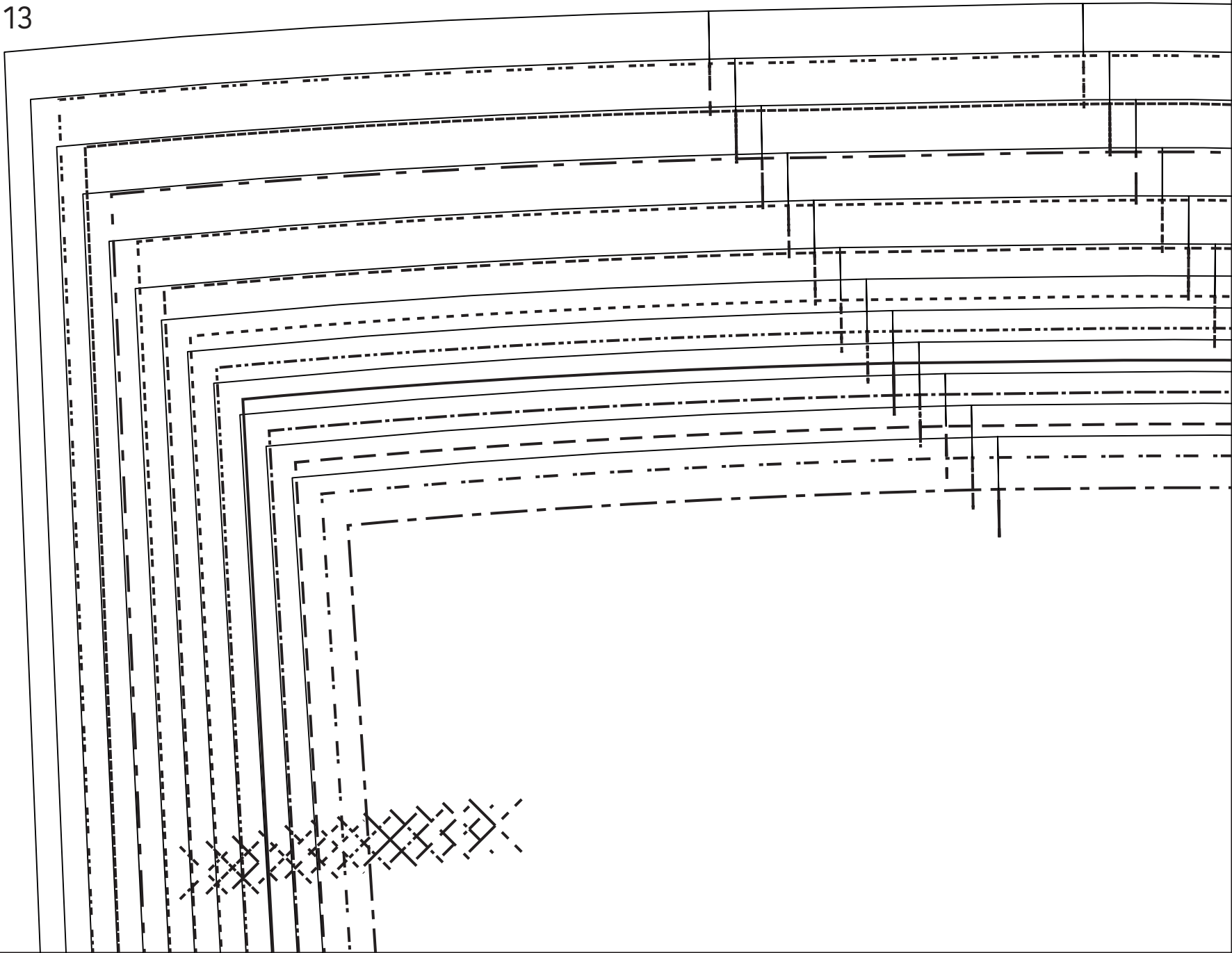

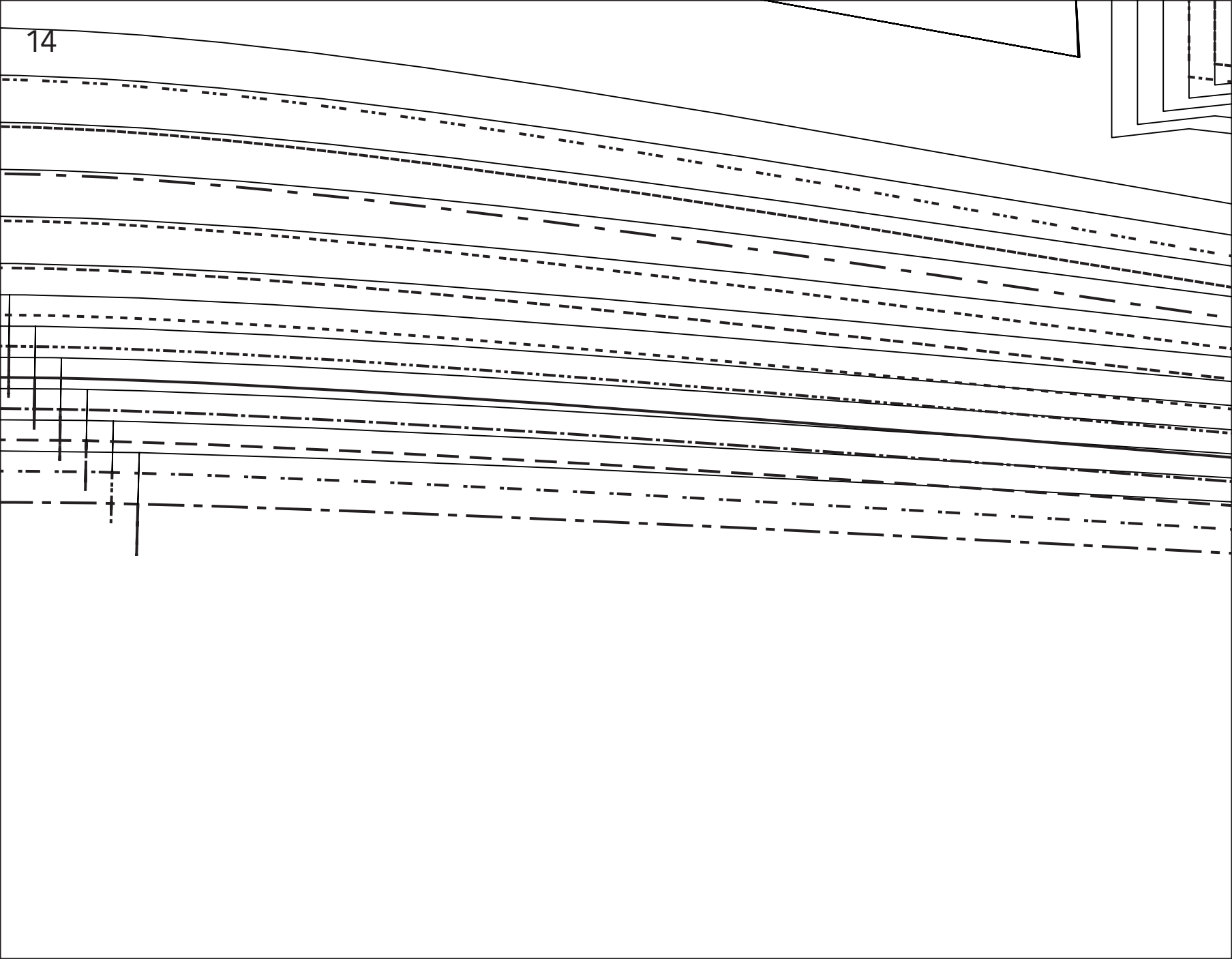

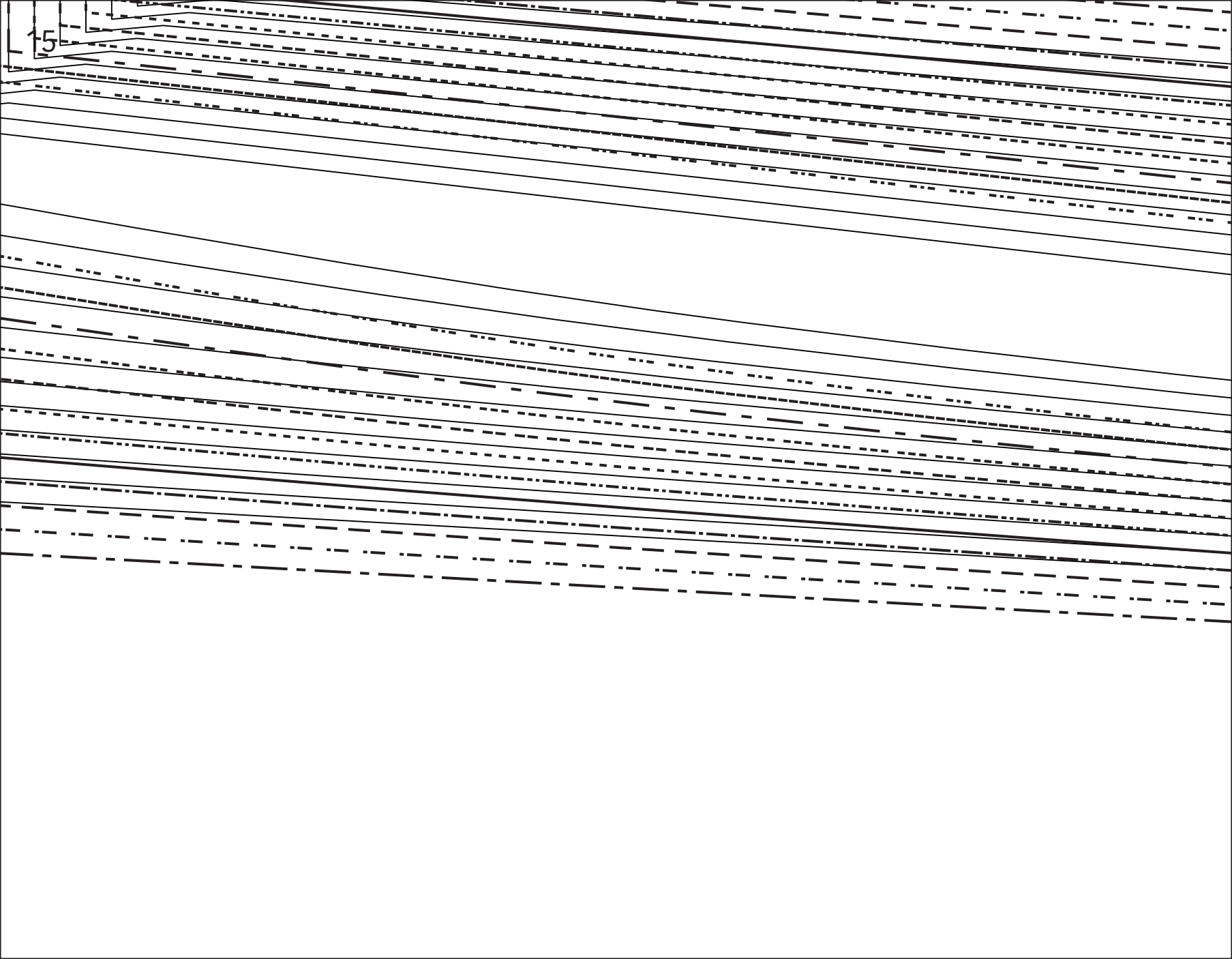

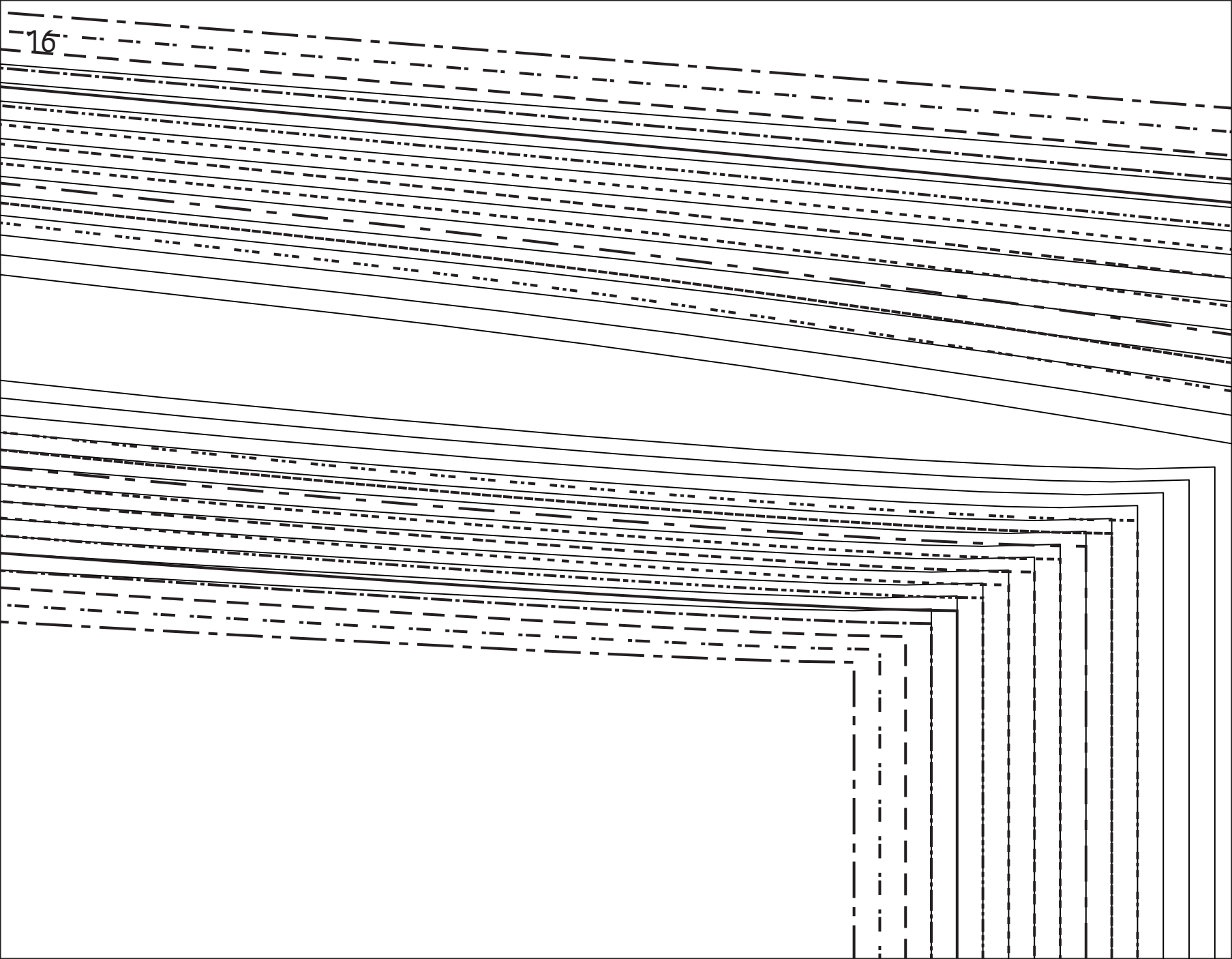



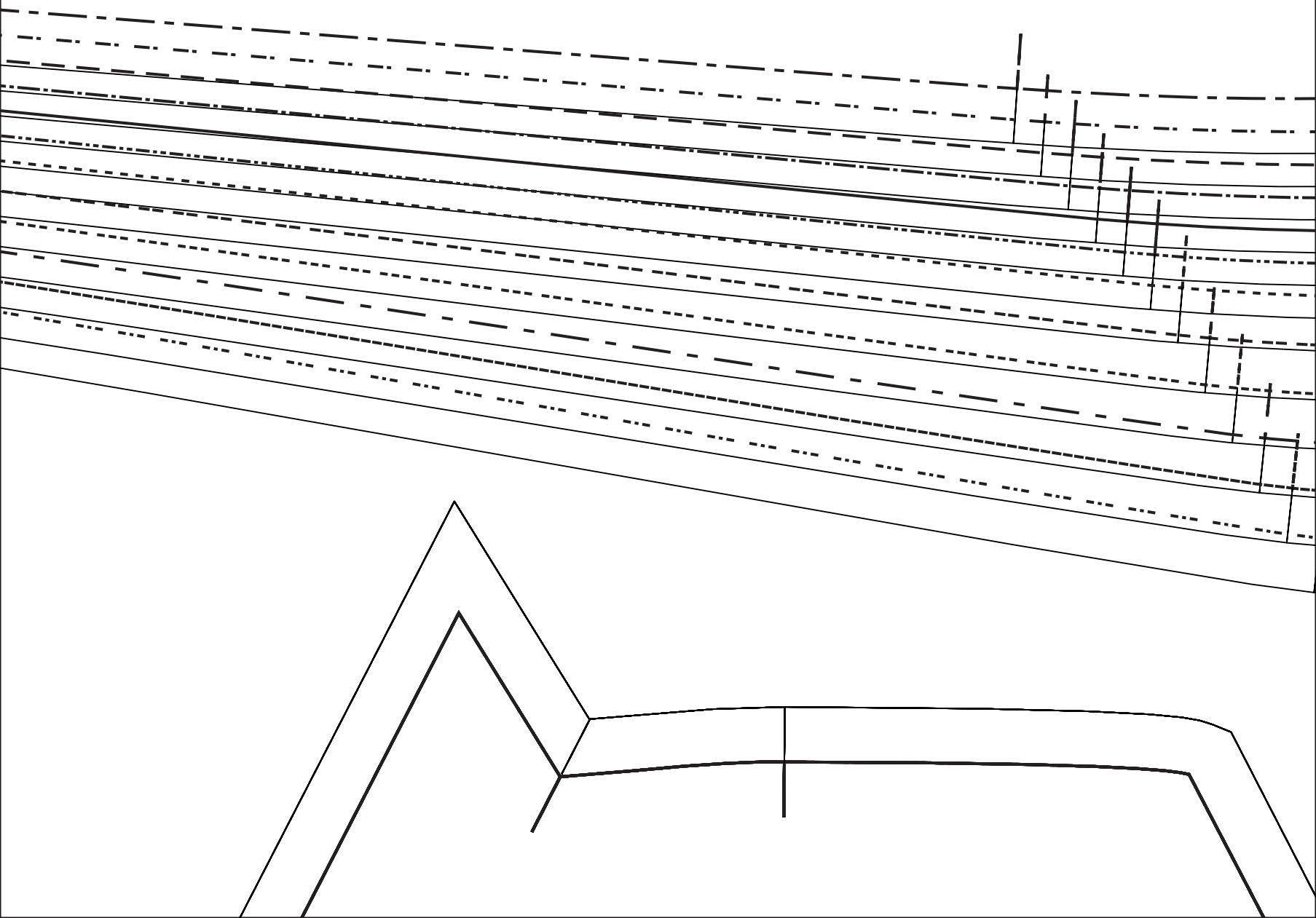

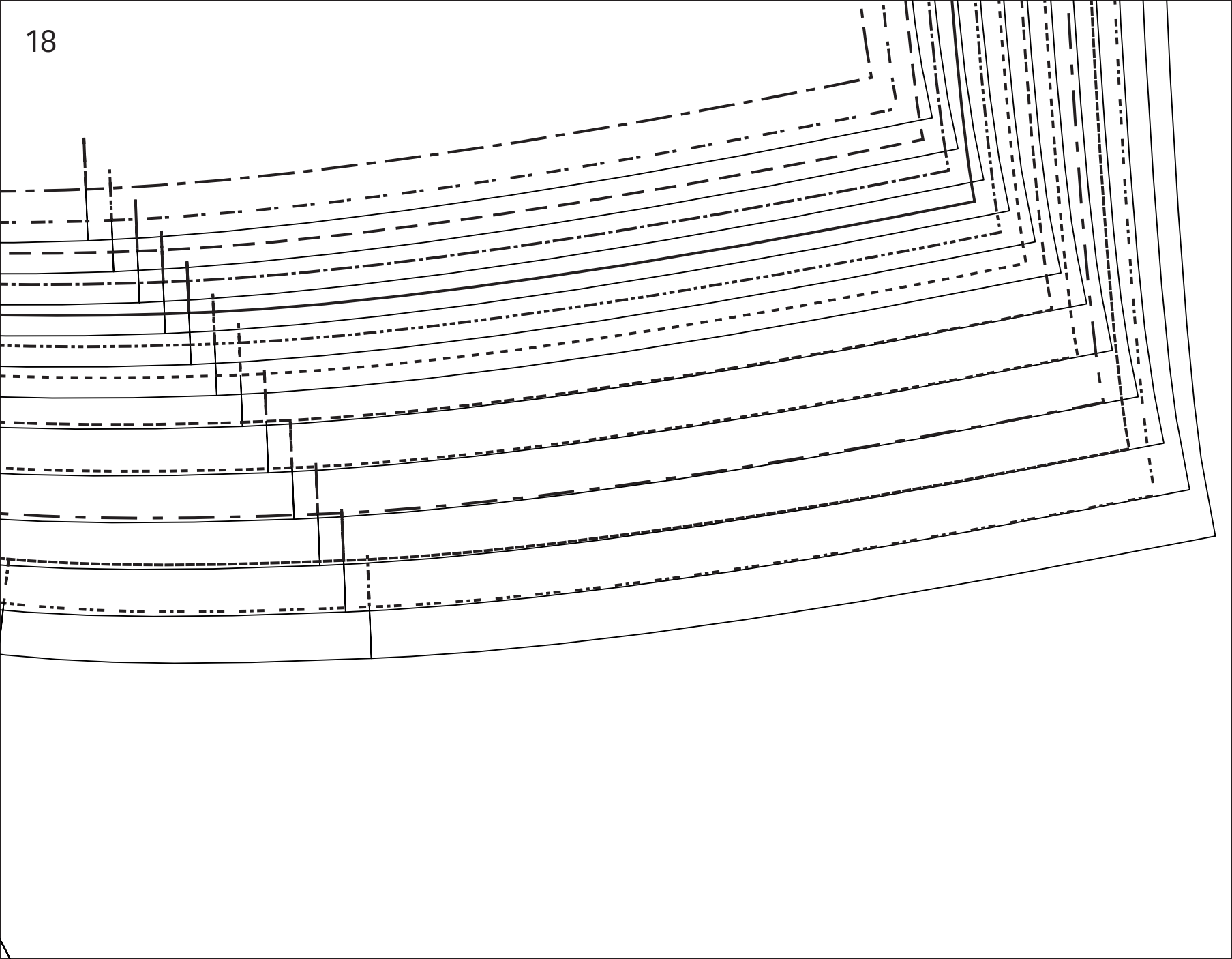



# Lubette - B

LA MAISON  
*Victor*

**B**



# Lubette - H

LA MAISON  
*Victor*

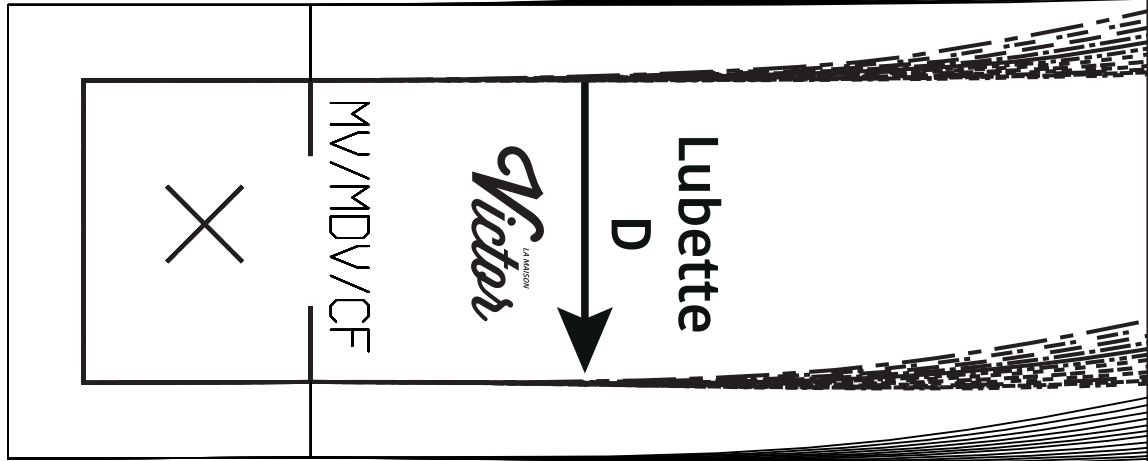

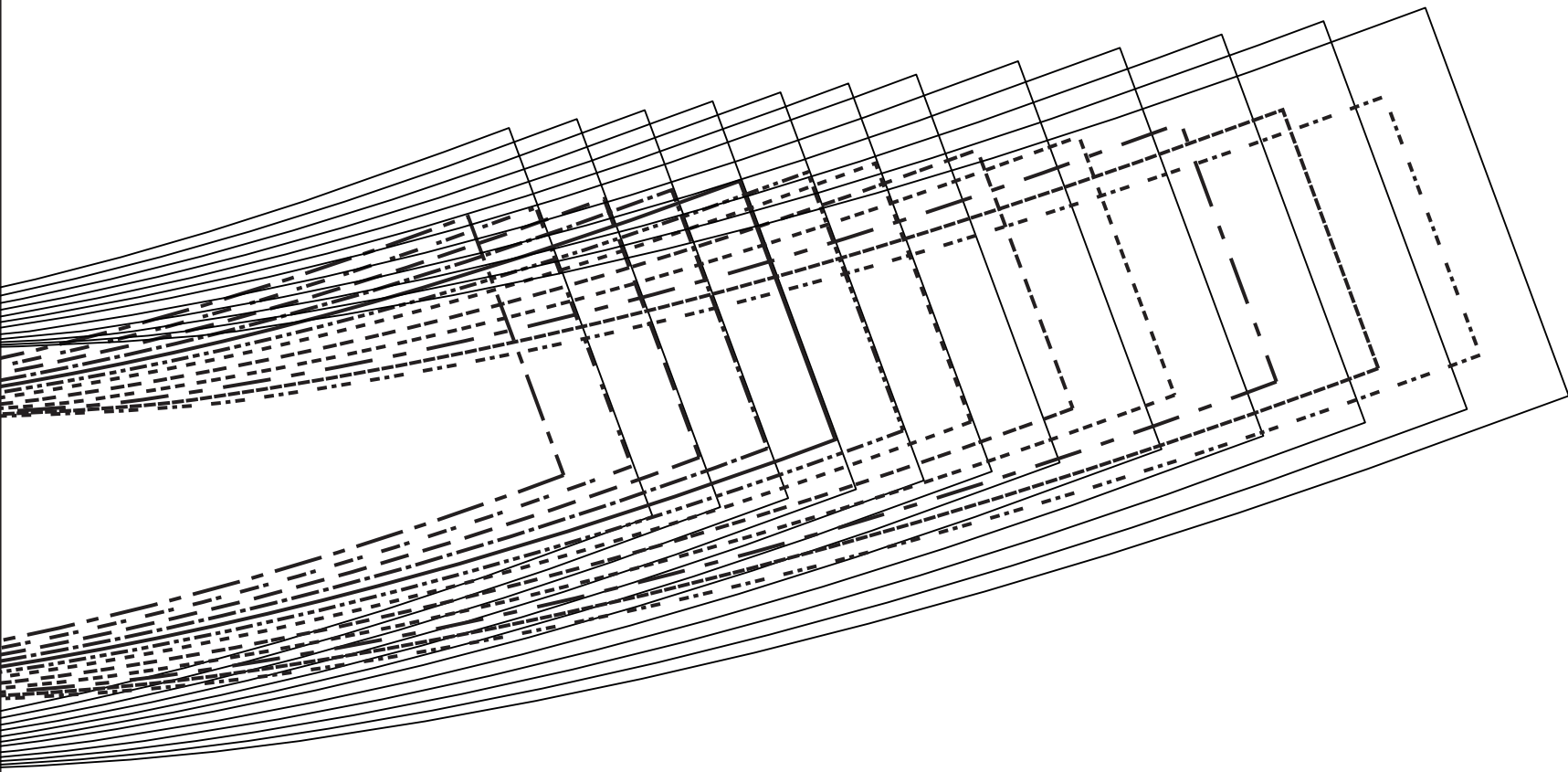



MR/MDS/CB  
MR/MDS/CB  
MR/MDS/CB

**Lubette - G**

*Victor*  
LA MAISON



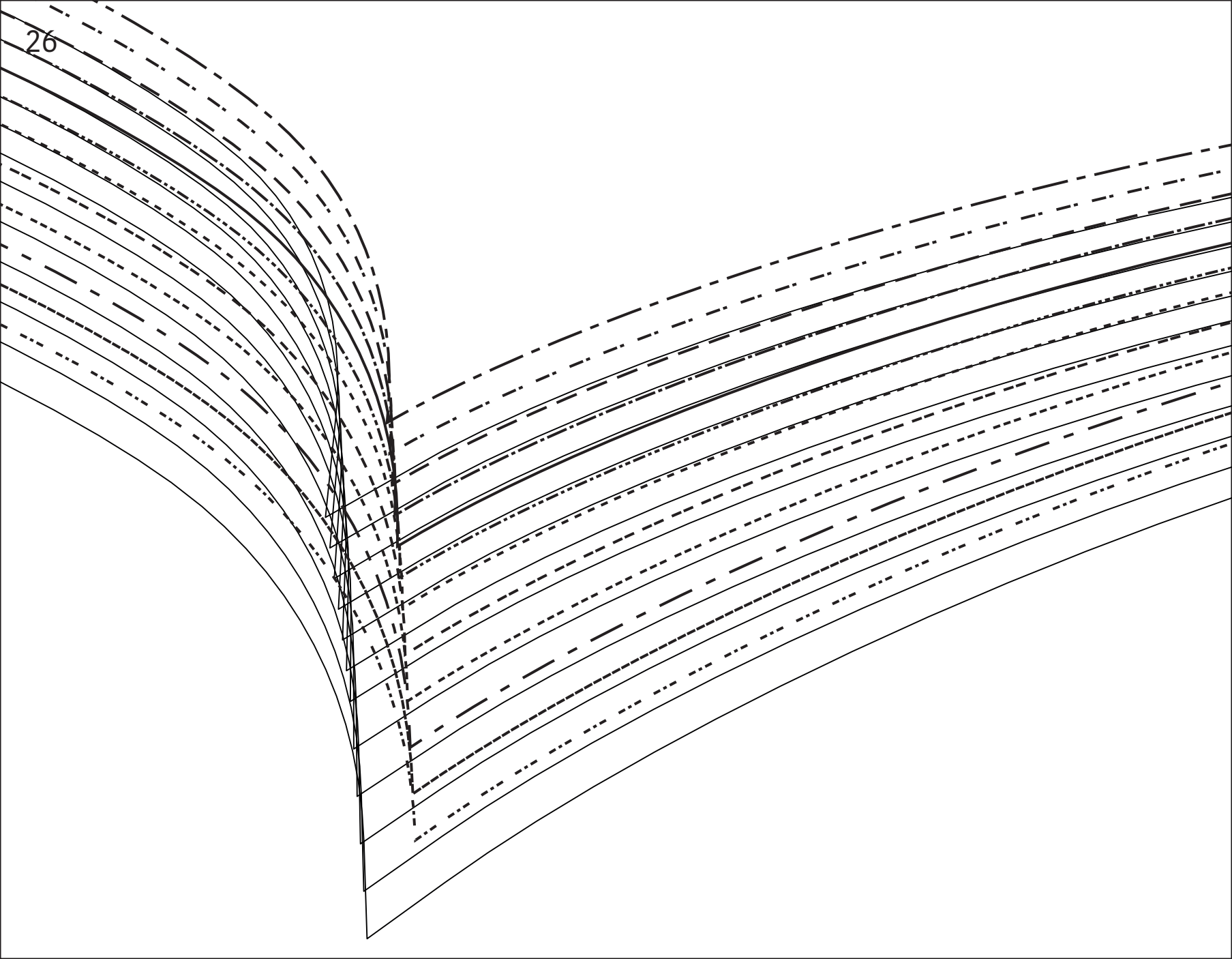

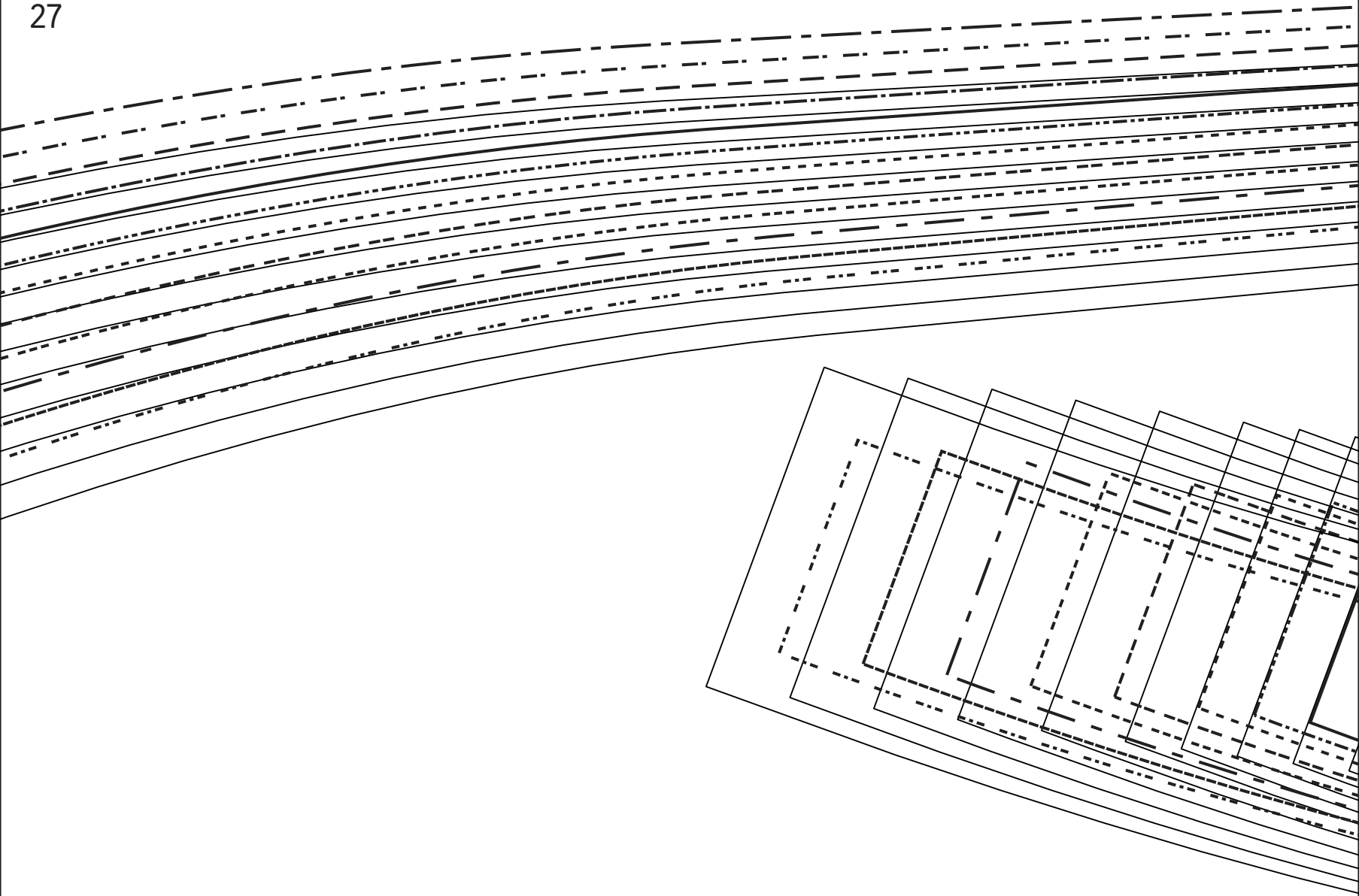

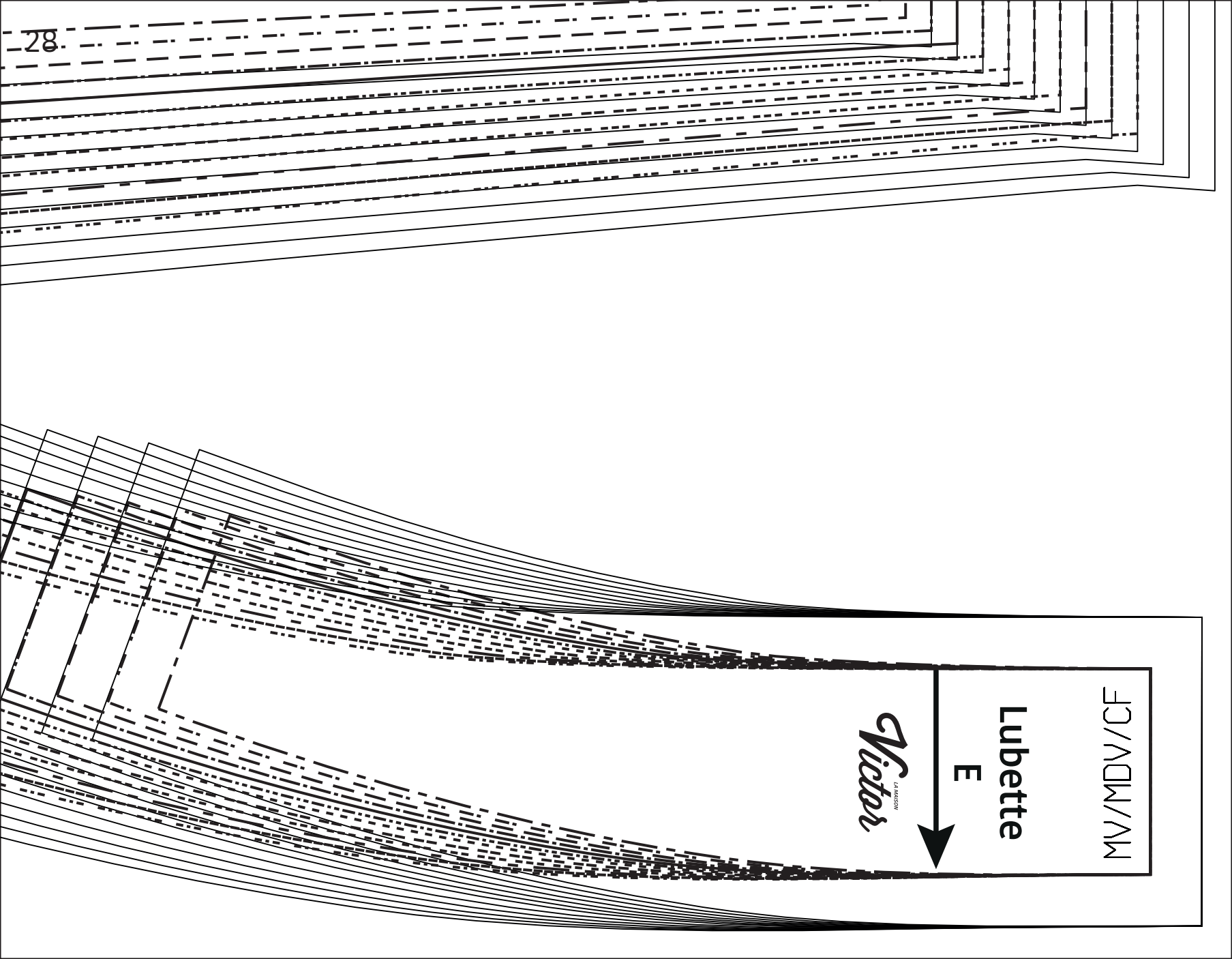

MV/MDV/CF

Lubette

E

*Victor*  
LUBRICANTS