

# Cato

## Broek / Pantalon / Trousers

### Maten / Tailles / Sizes:

-----	34
-----	36
-----	38
-----	40
-----	42
-----	44
-----	46
-----	48
-----	50
-----	52
-----	54
-----	56

### Patroondelen / Pièces du patron / Pattern pieces:

- A** voorpand / devant / front panel
- B** rugpand / dos / back panel
- C** zak / poche / pocket
- D** riemlussen / passants / belt loops
- E** beleg RVP / parementure DVD /  
front right facing
- F** beleg LVP / parementure DVG /  
front left facing
- G** beleg RP / parementure DS /  
back facing
- H** gulpstuk / braguette / fly

## Patroonschema / Schéma du Patron / Pattern Diagram / Übersichtsplan zum Zusammenkleben

1	2	3	4	5	6
7	8	9	10	11	12
13	14	15	16	17	18
19	20	21	22	23	24
25	26	27	28	29	30
31	32	33	34	35	

### Controlevierkant / Carré de controle / Test square / Kontrollquadrat

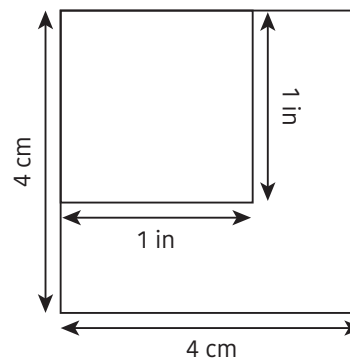

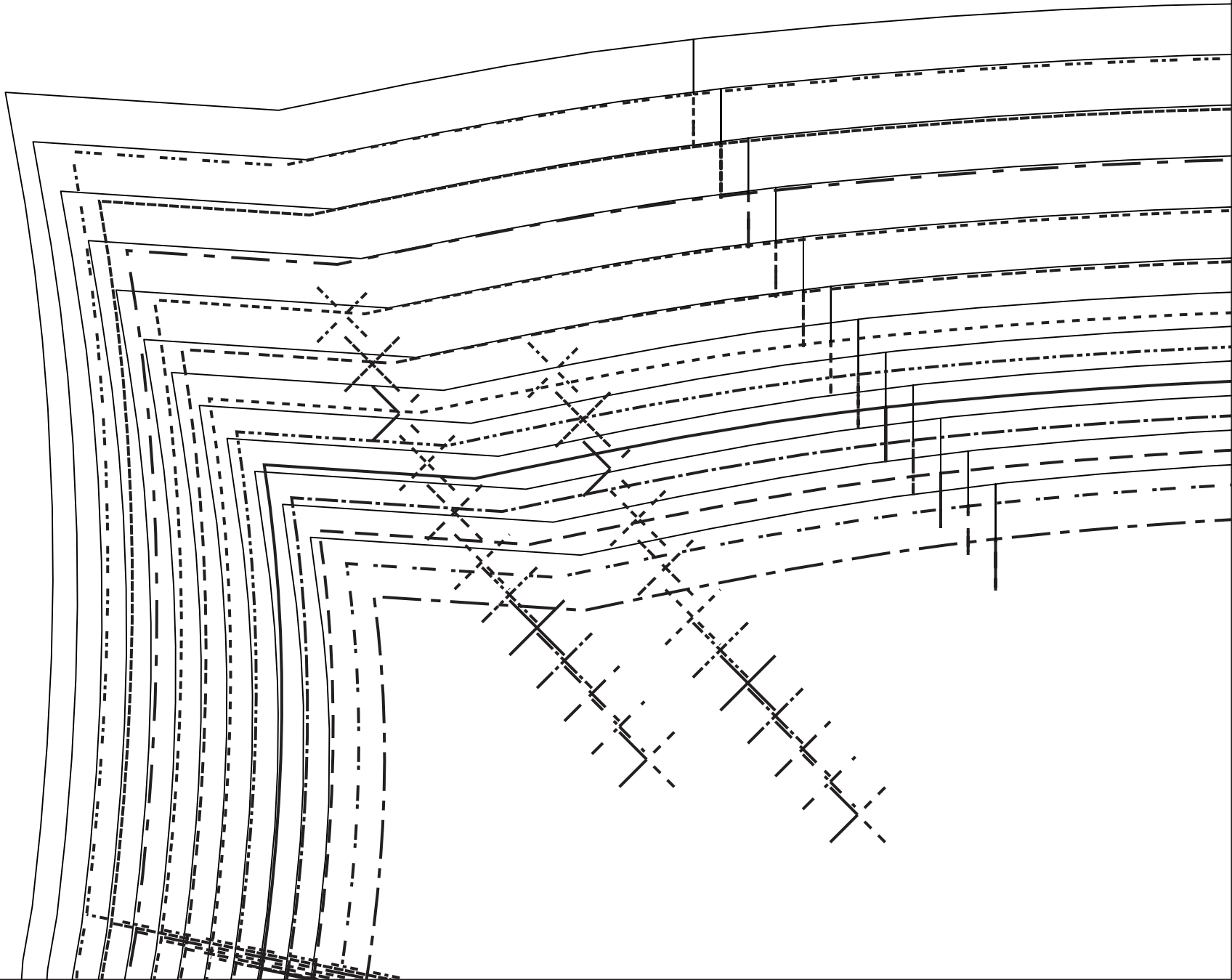

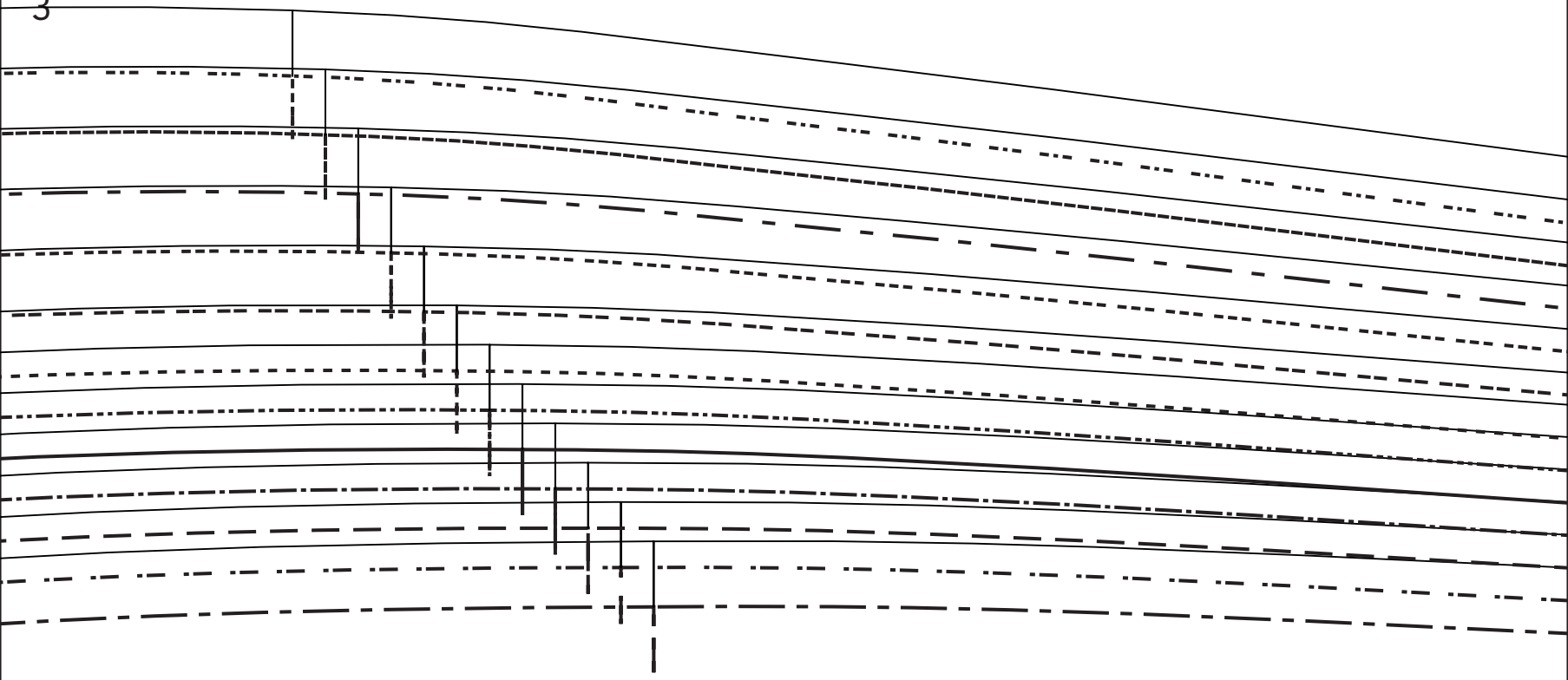

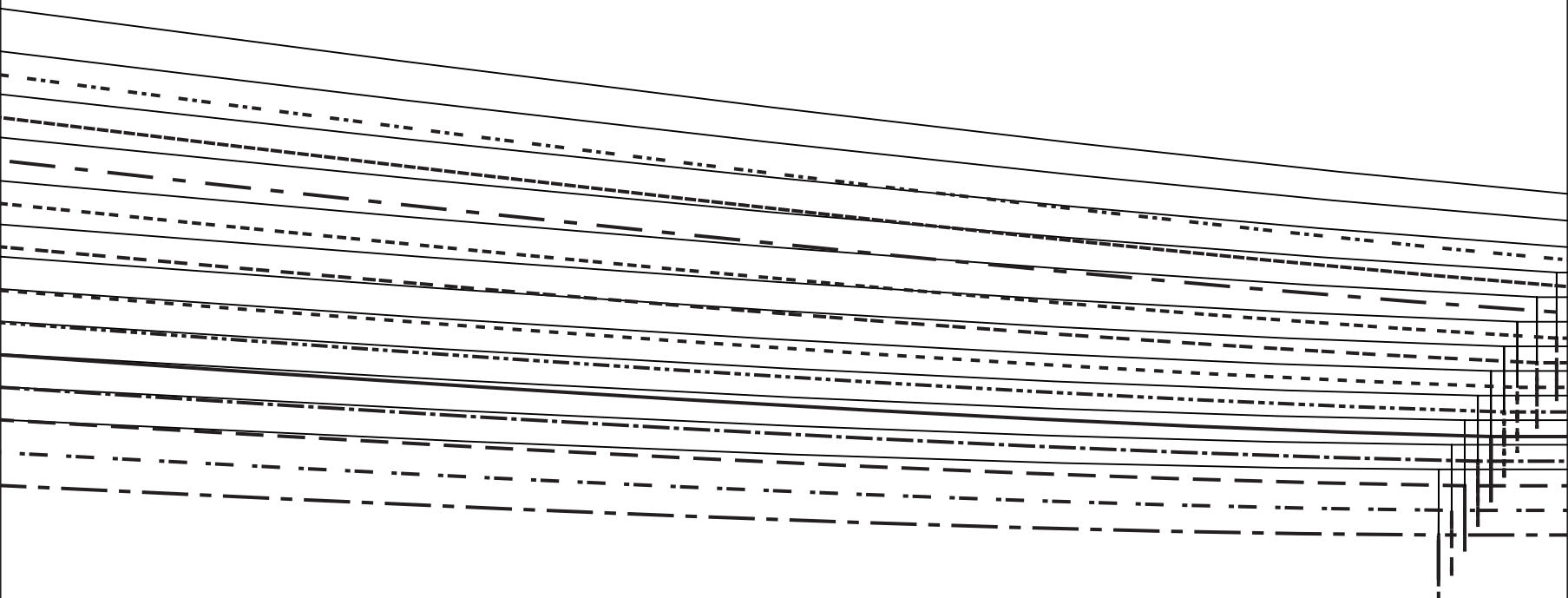



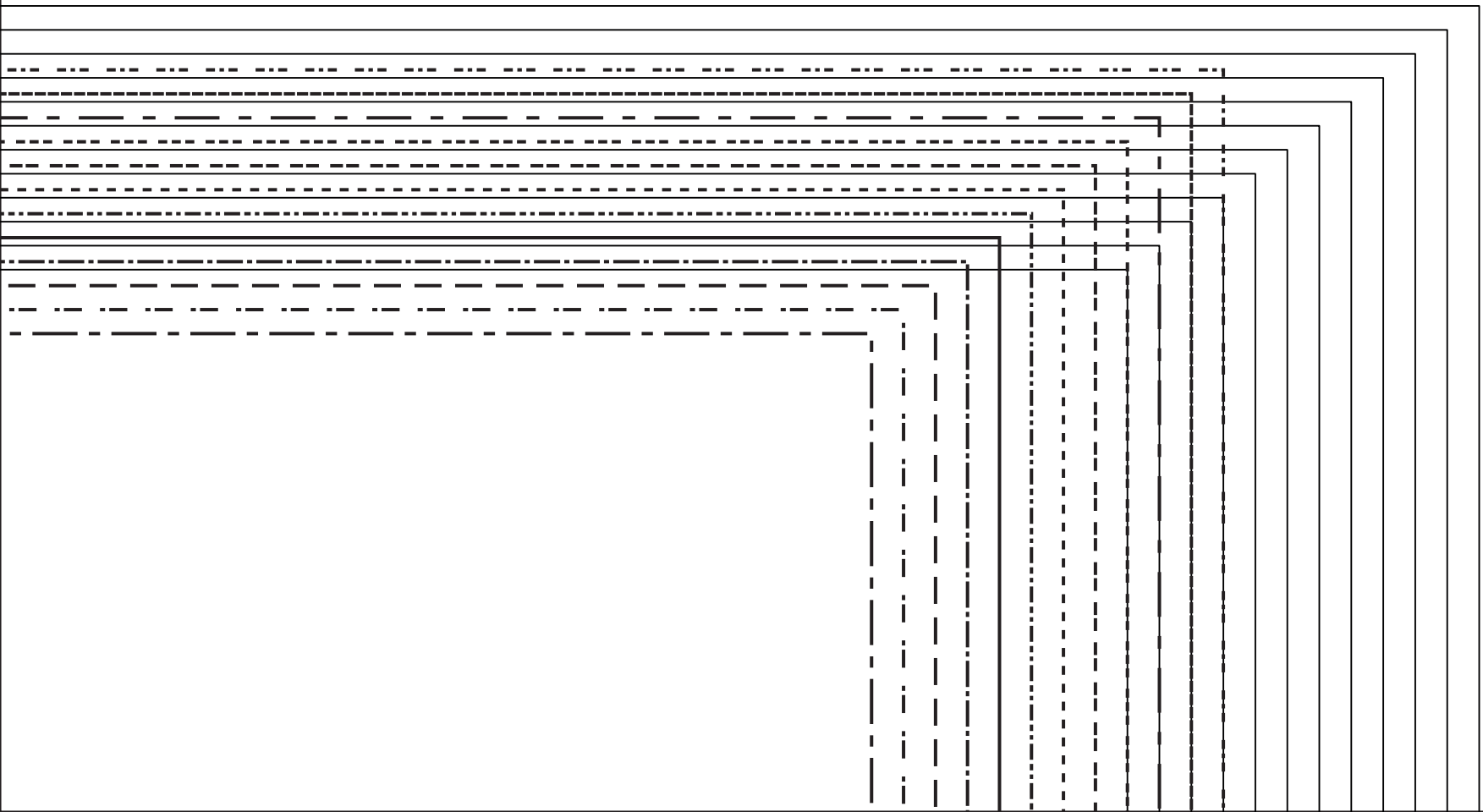

CATO - C



LA MAISON  
*Victor*

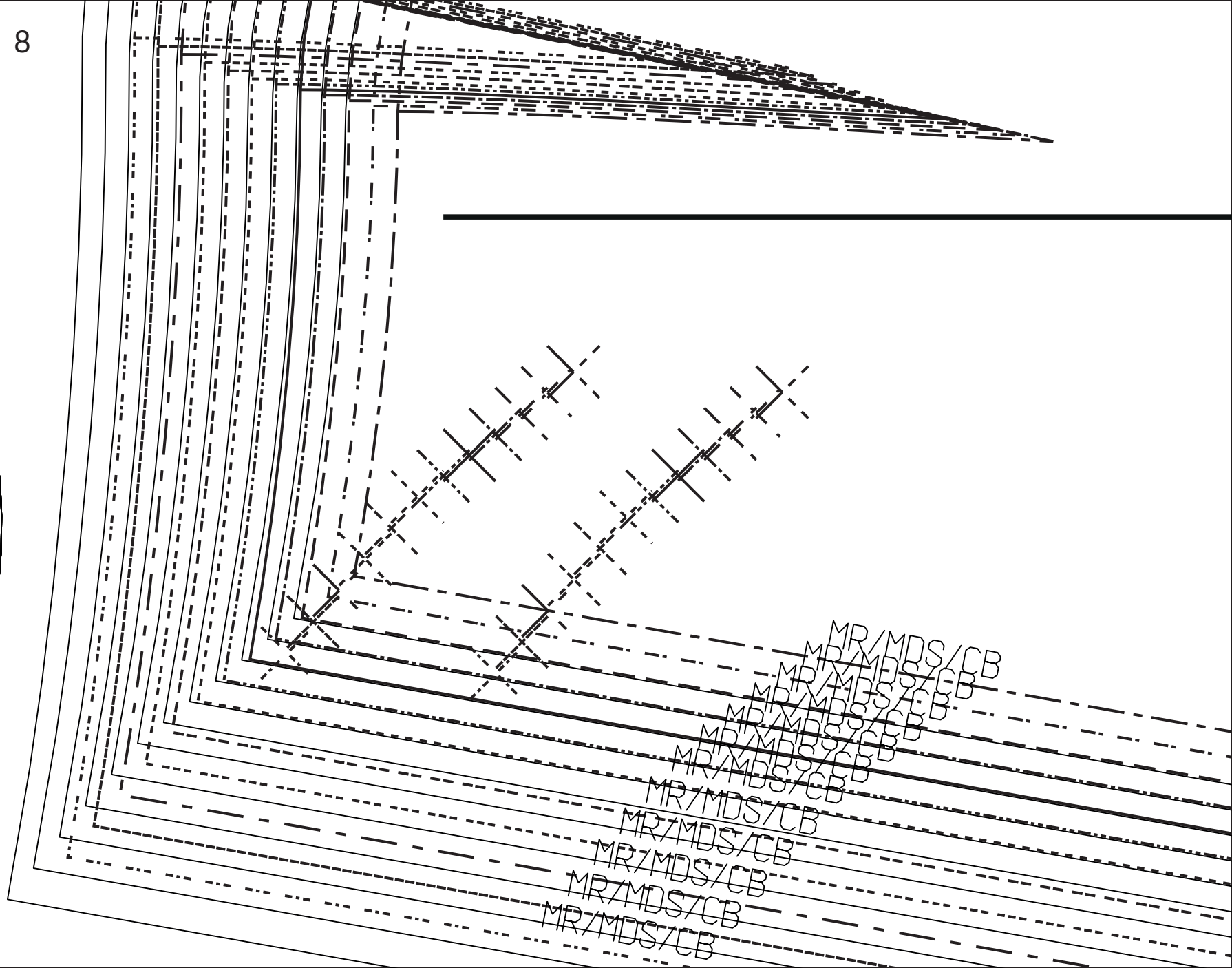

MR/MDS/CB  
MR/MDS/CB  
MR/MDS/CB  
MR/MDS/CB  
MR/MDS/CB  
MR/MDS/CB  
MR/MDS/CB  
MR/MDS/CB



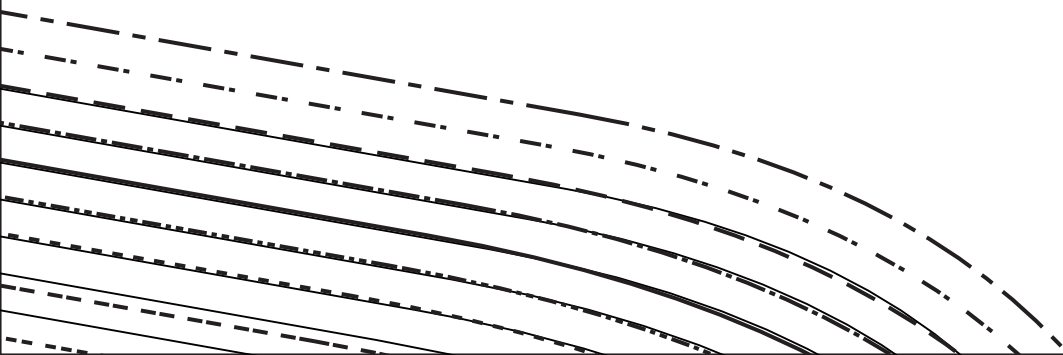

# CATO - B

---

*Victor*  
LA MAISON





CATO - H

LA MAISON  
*Victor*

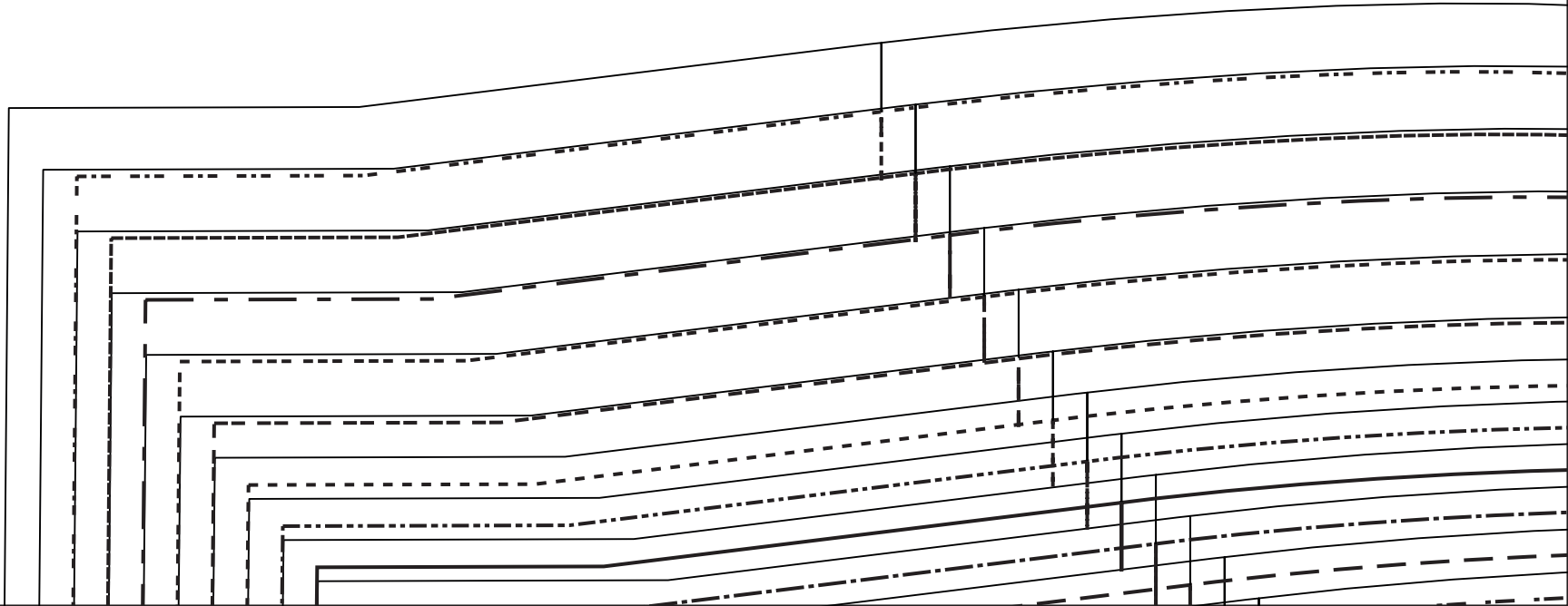

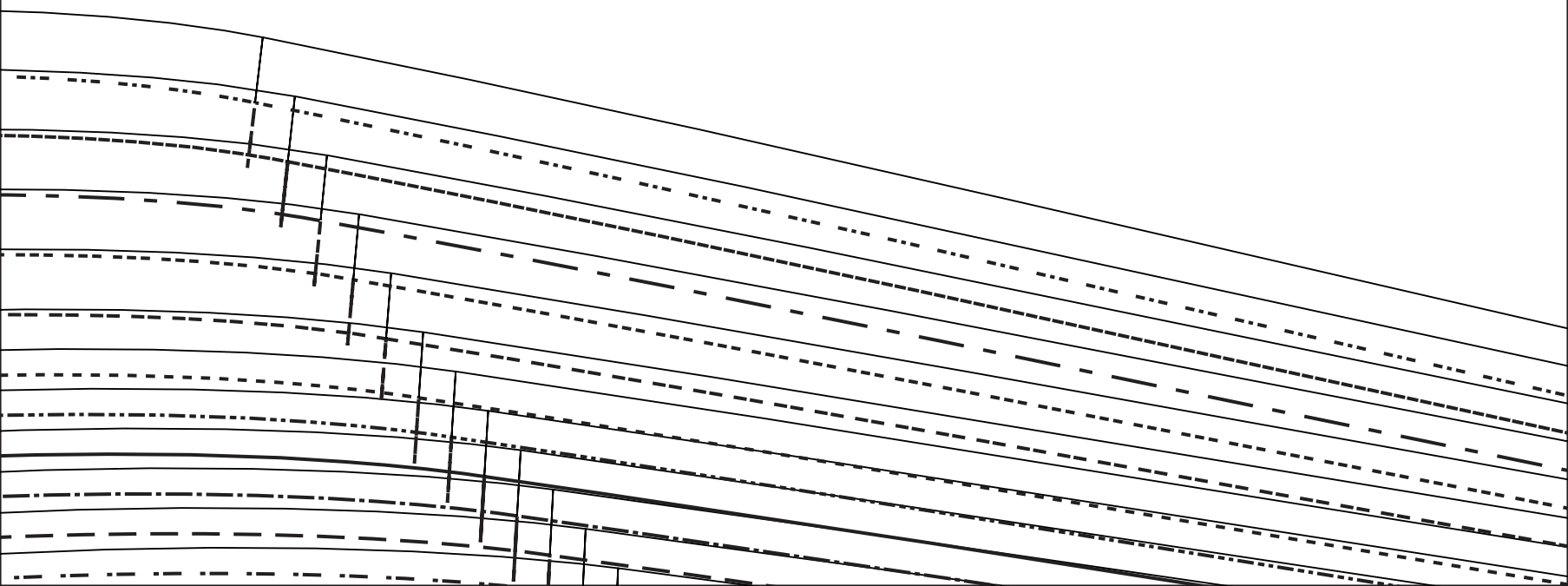
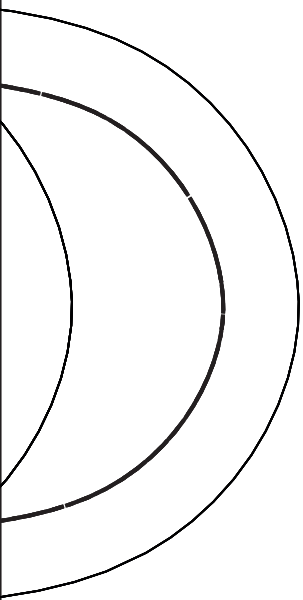

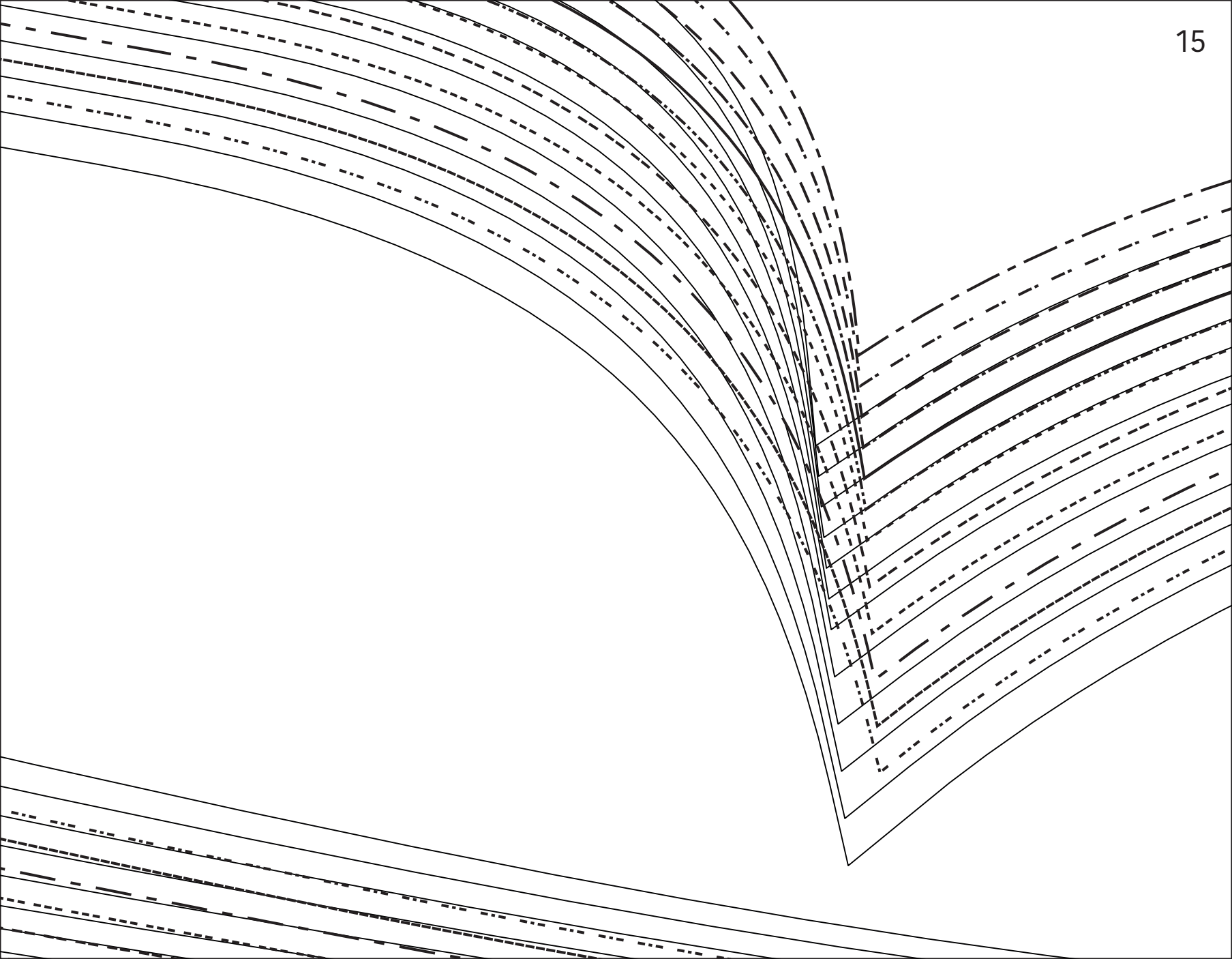

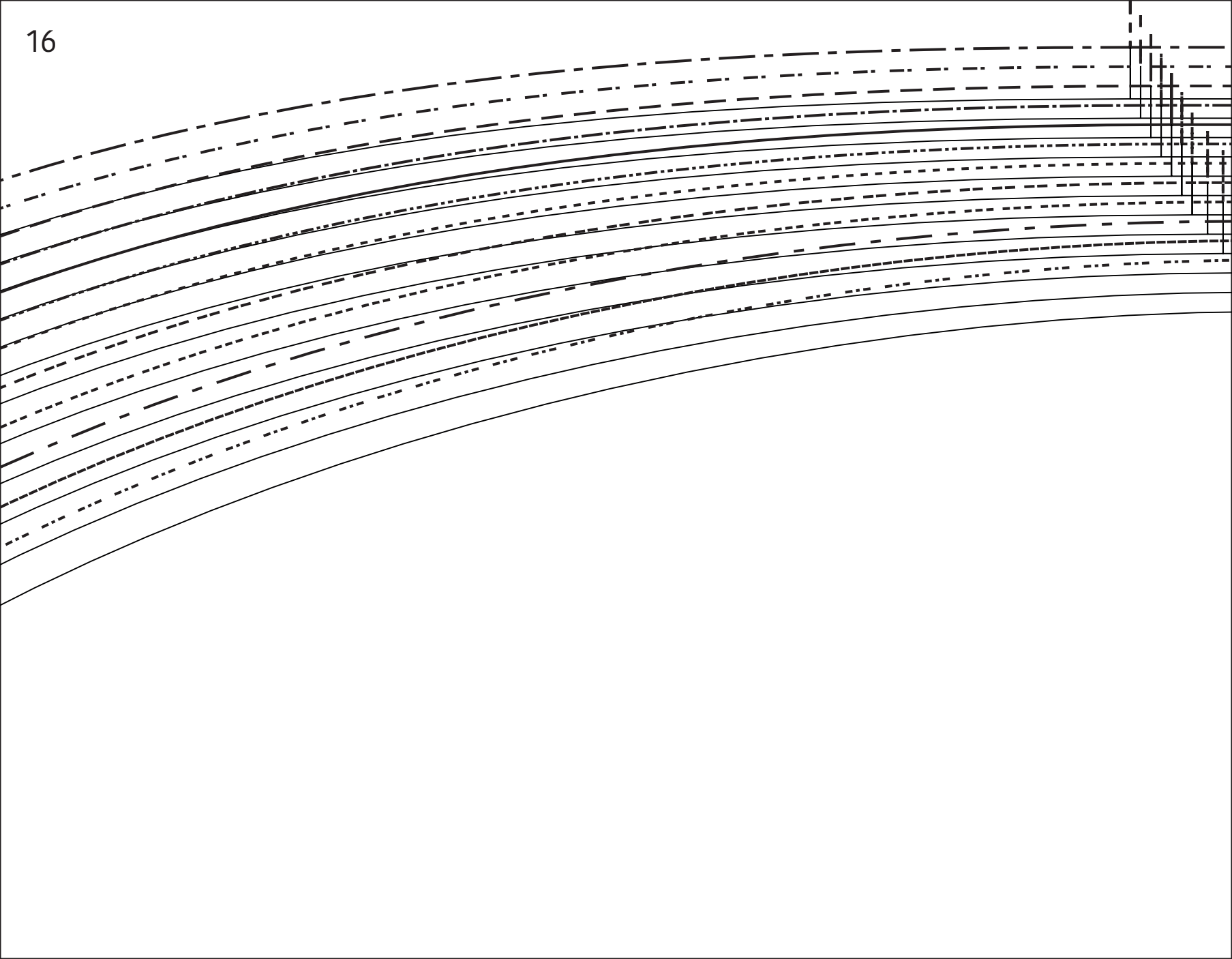



CATO - E

*Victor*  
LA MAISON



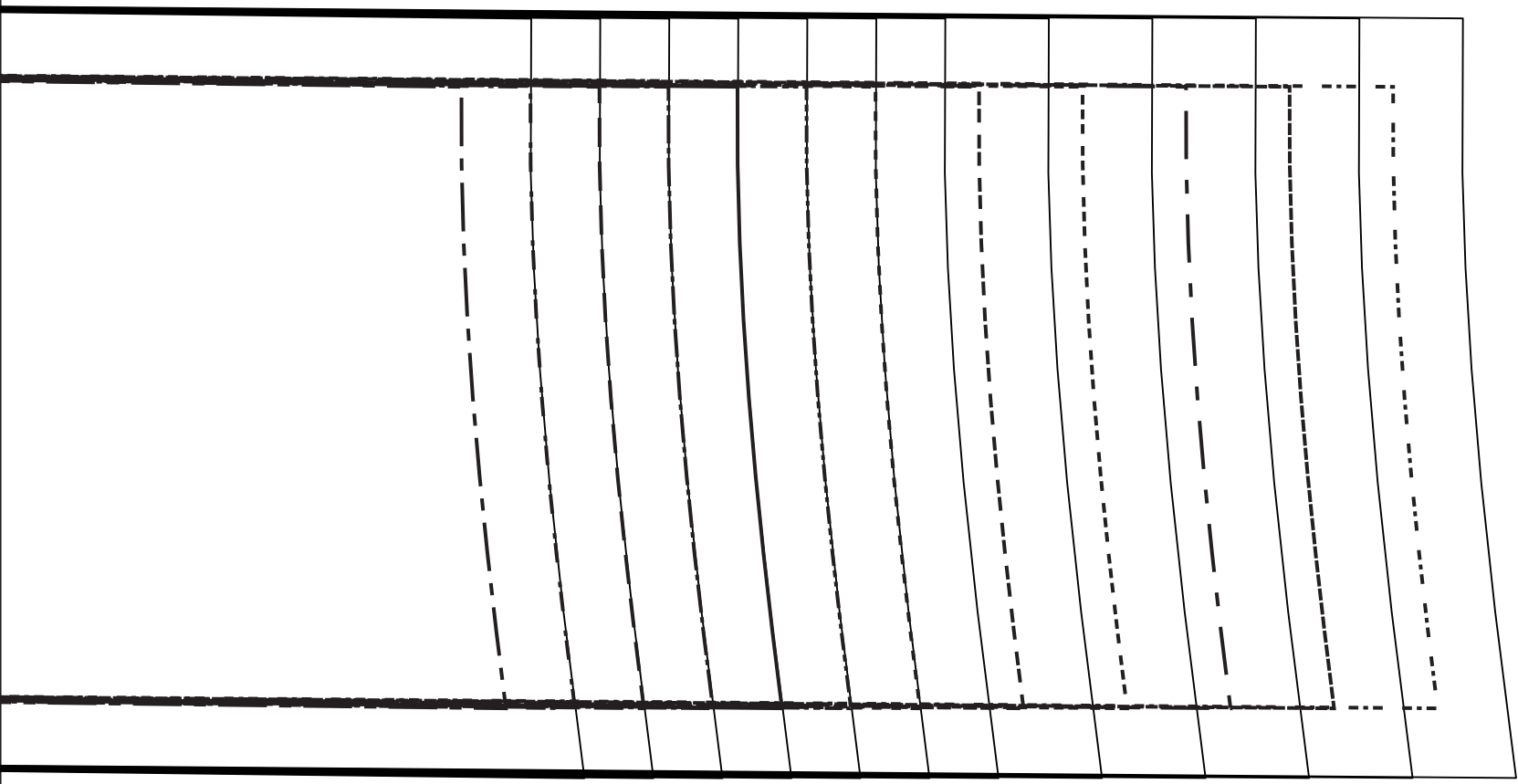
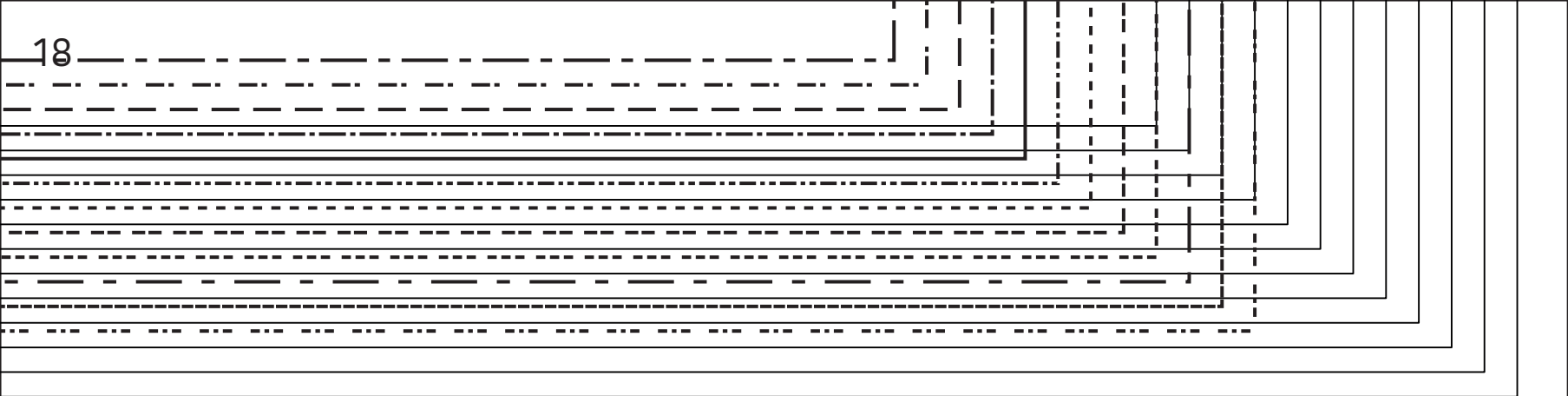

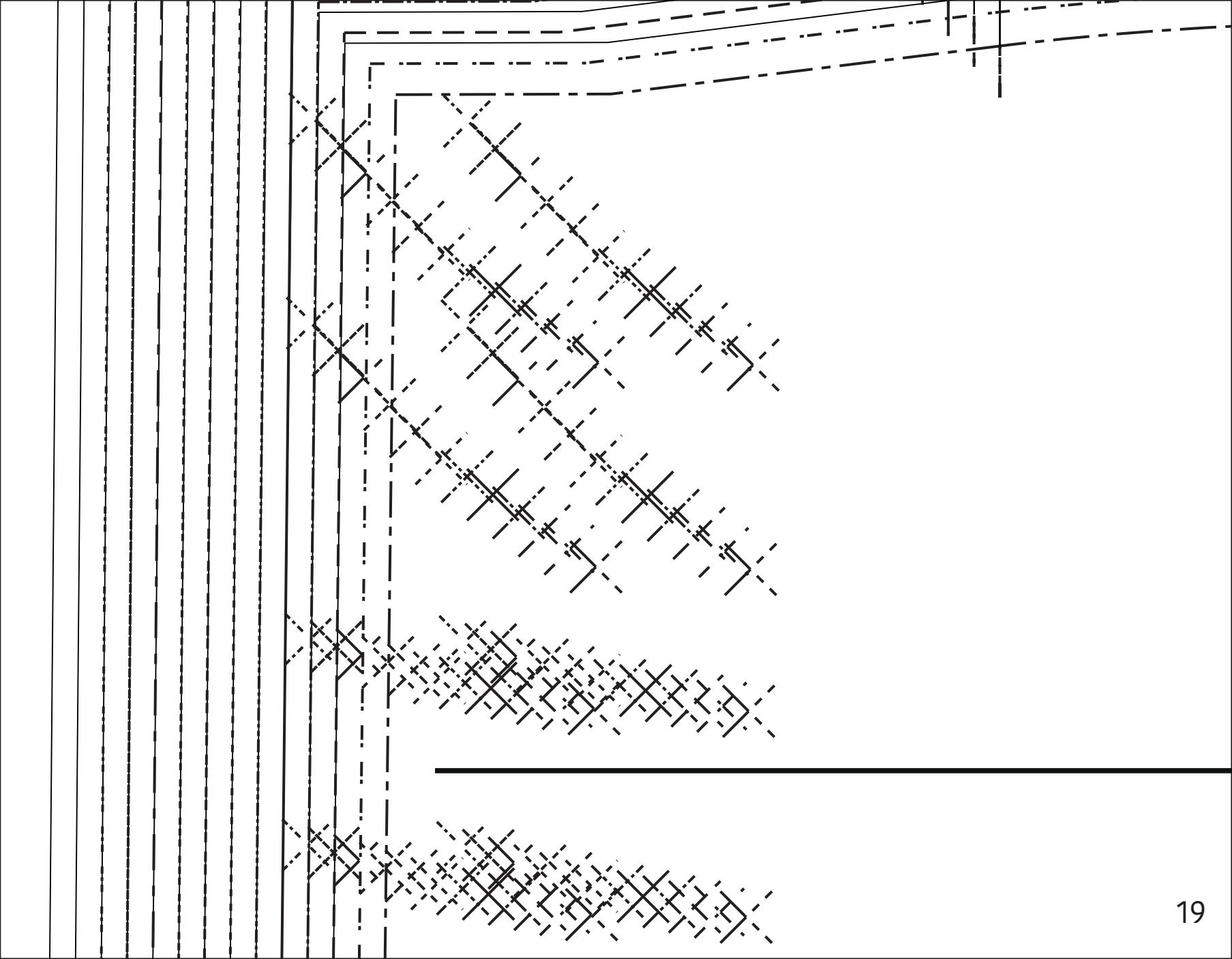

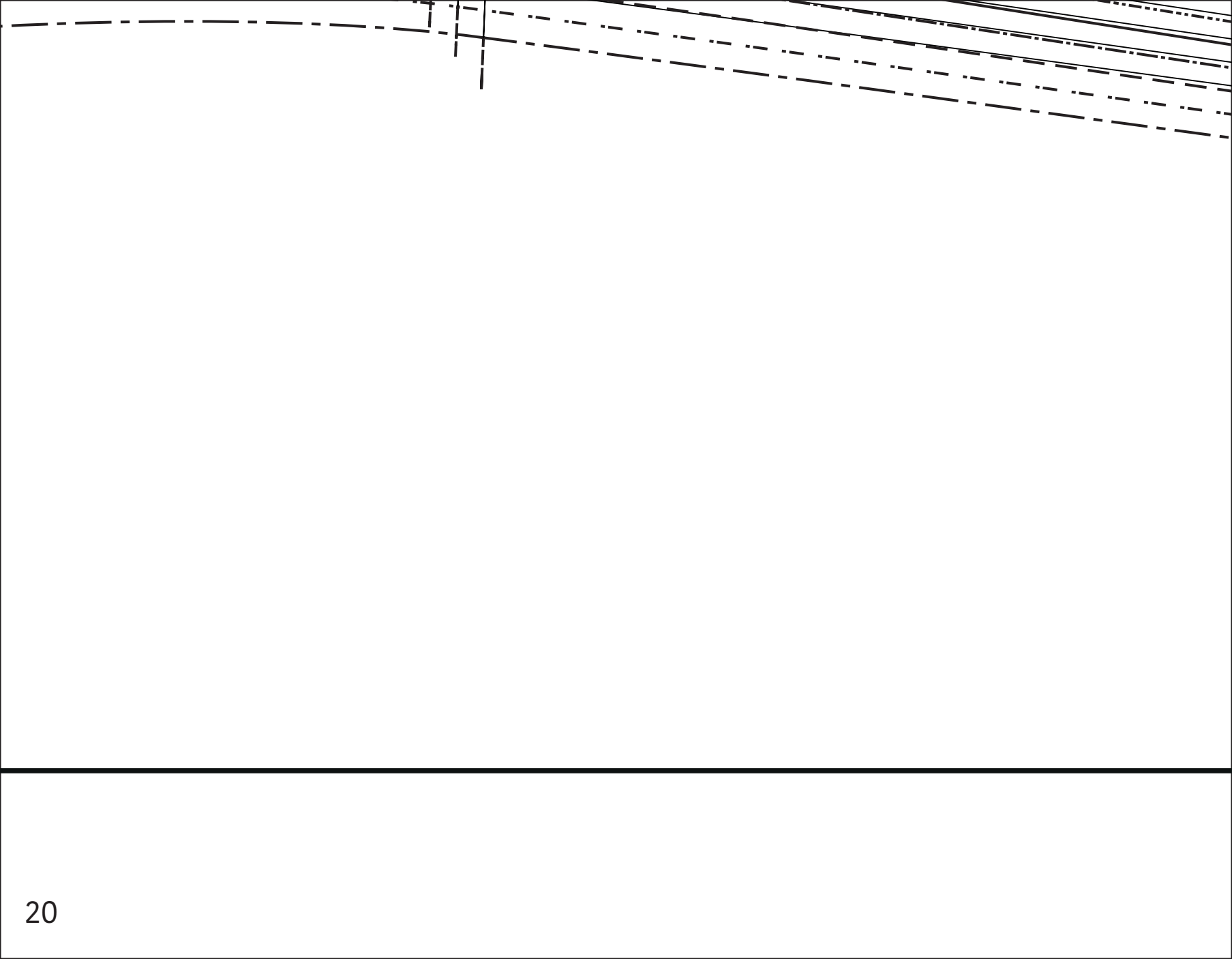



# CATO - A

LA MAISON  
*Victor*

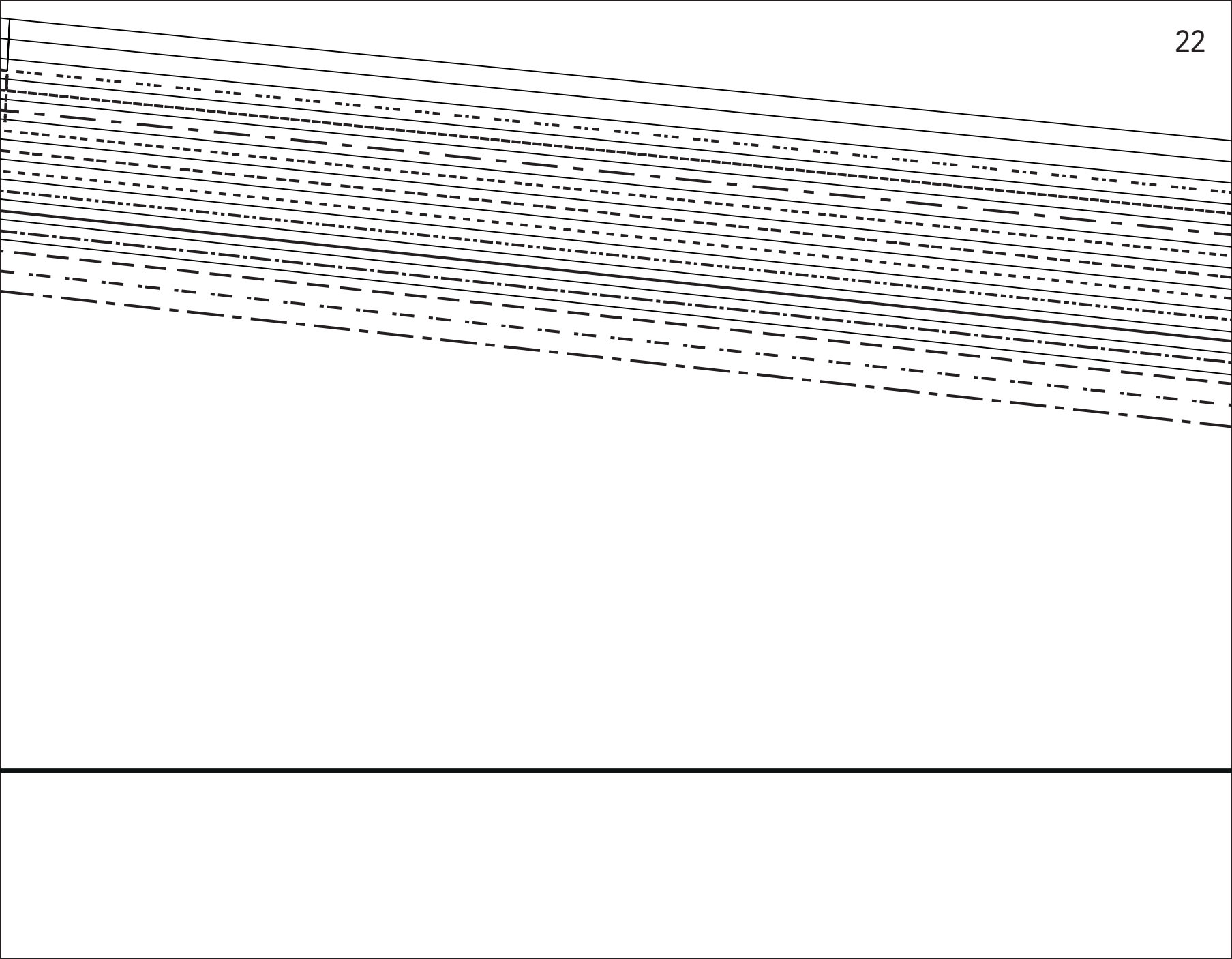

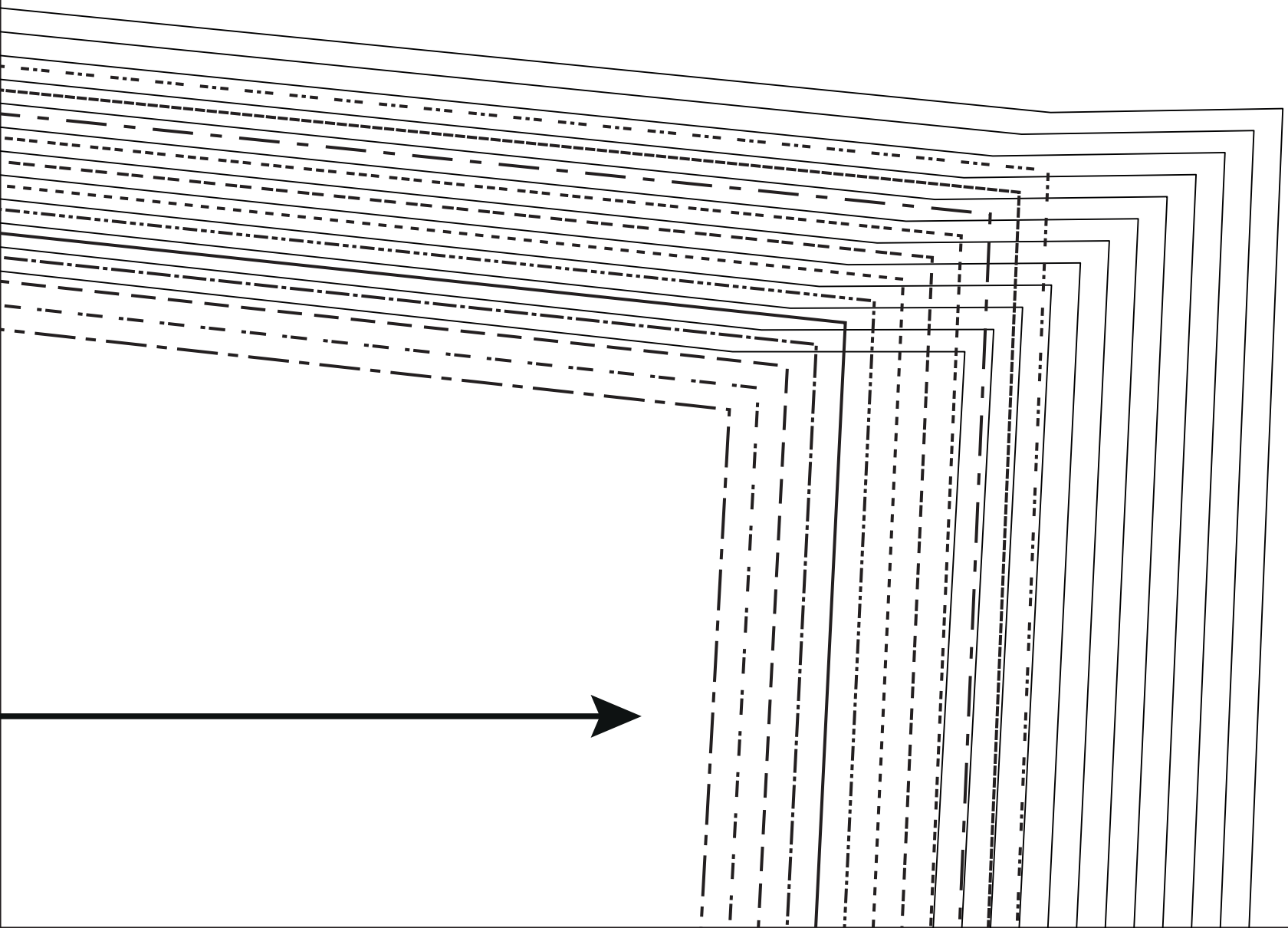

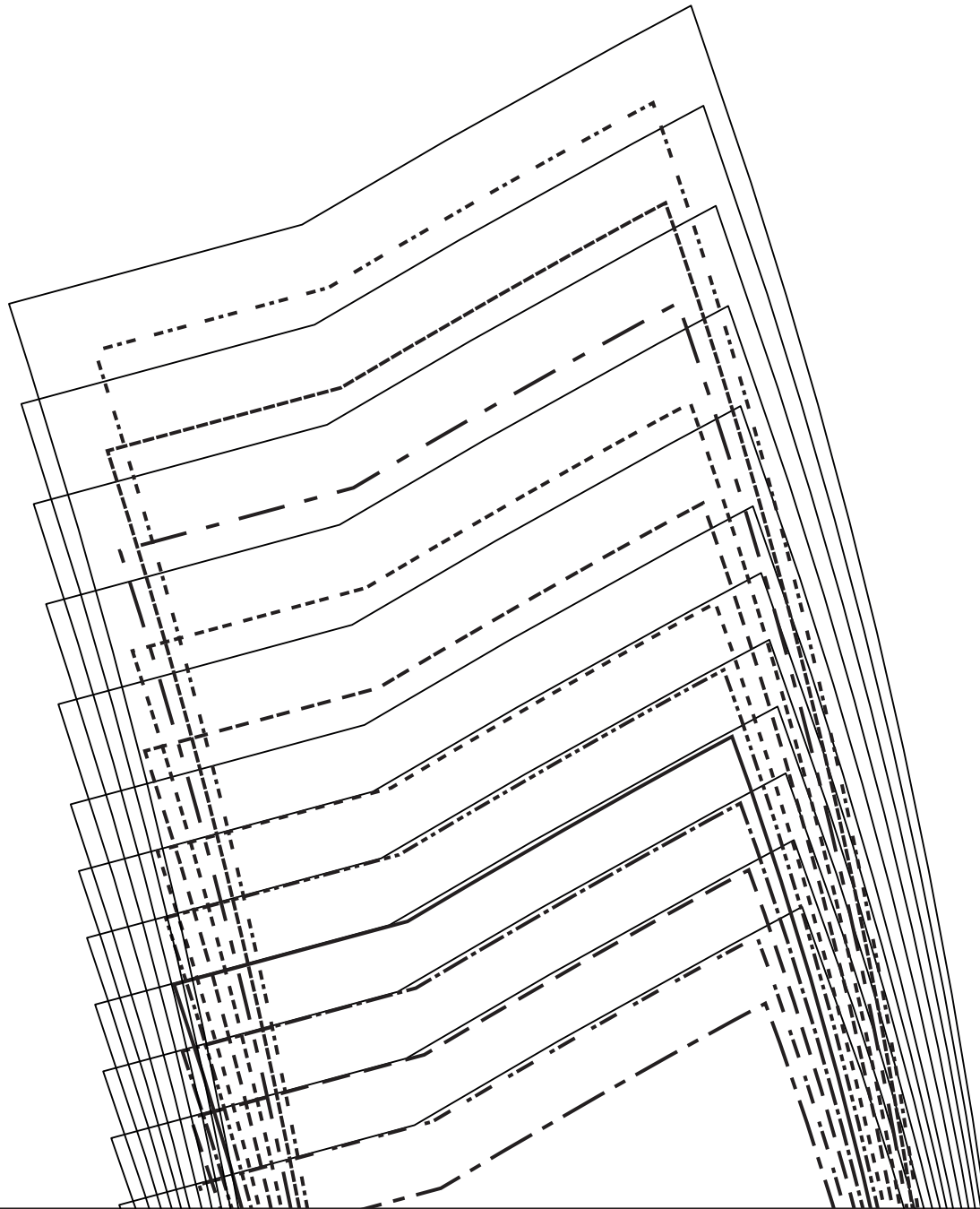



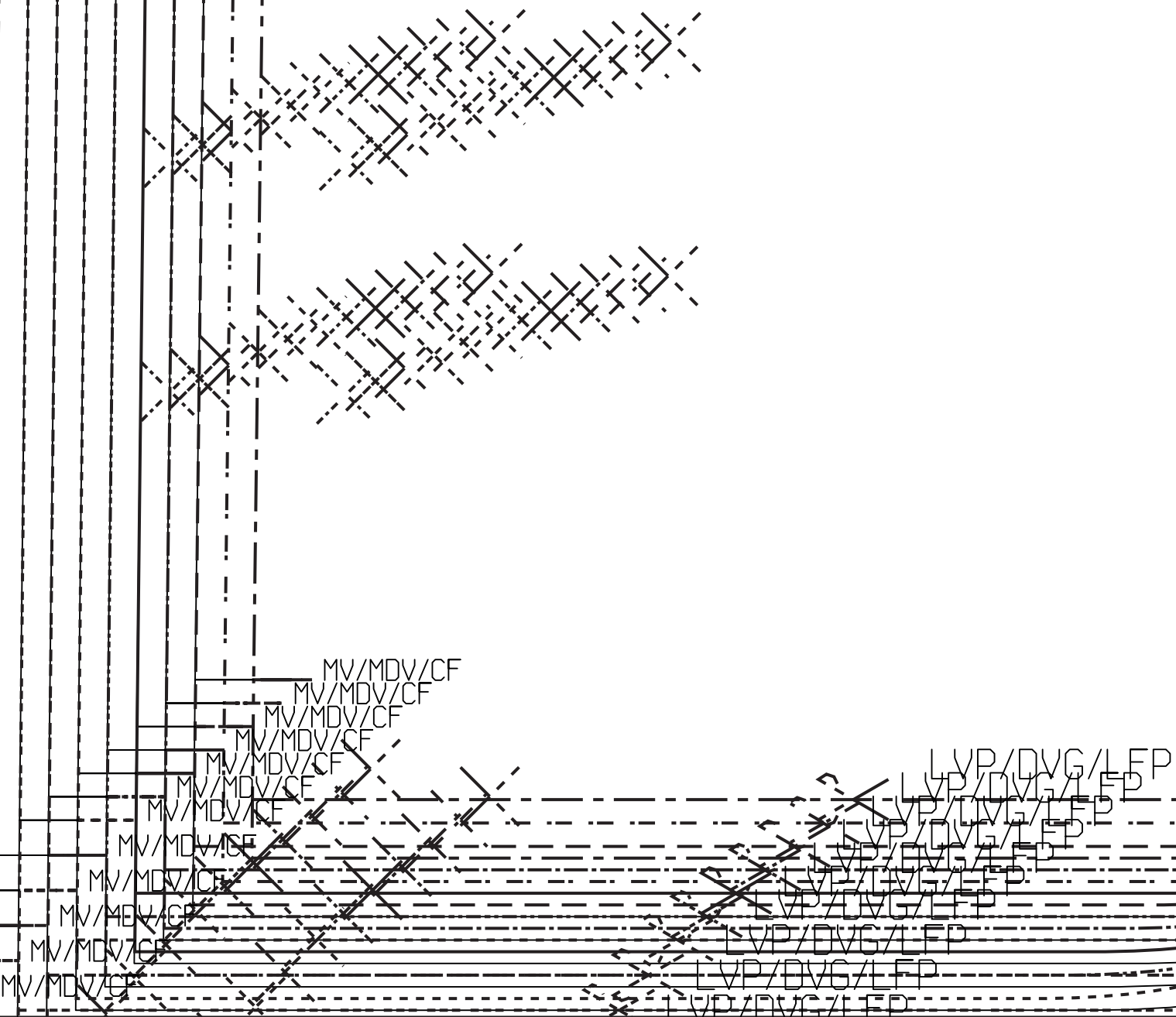

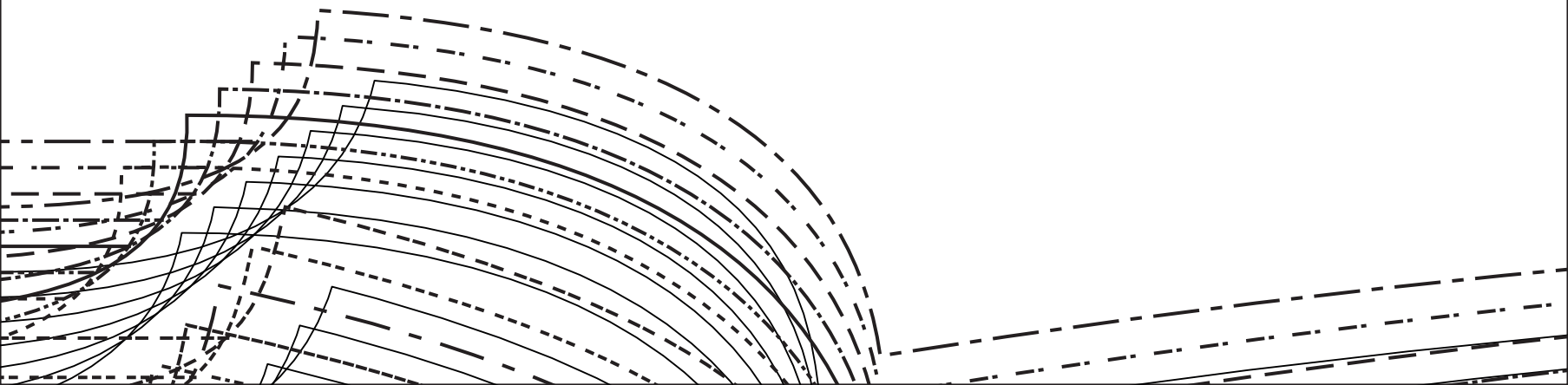

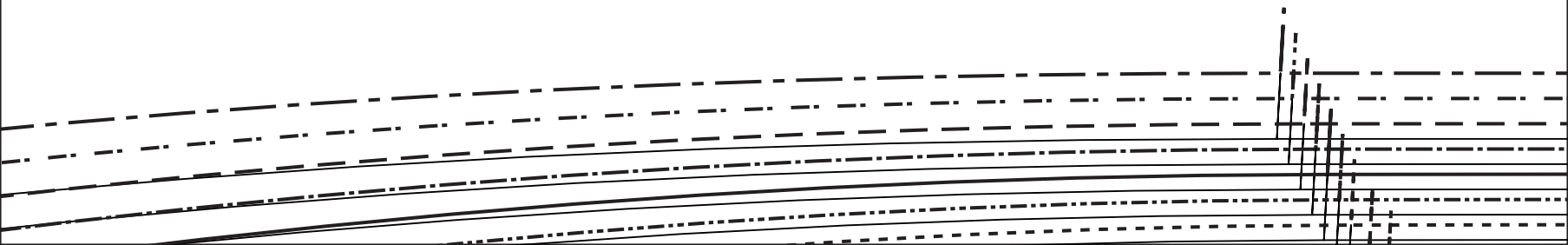



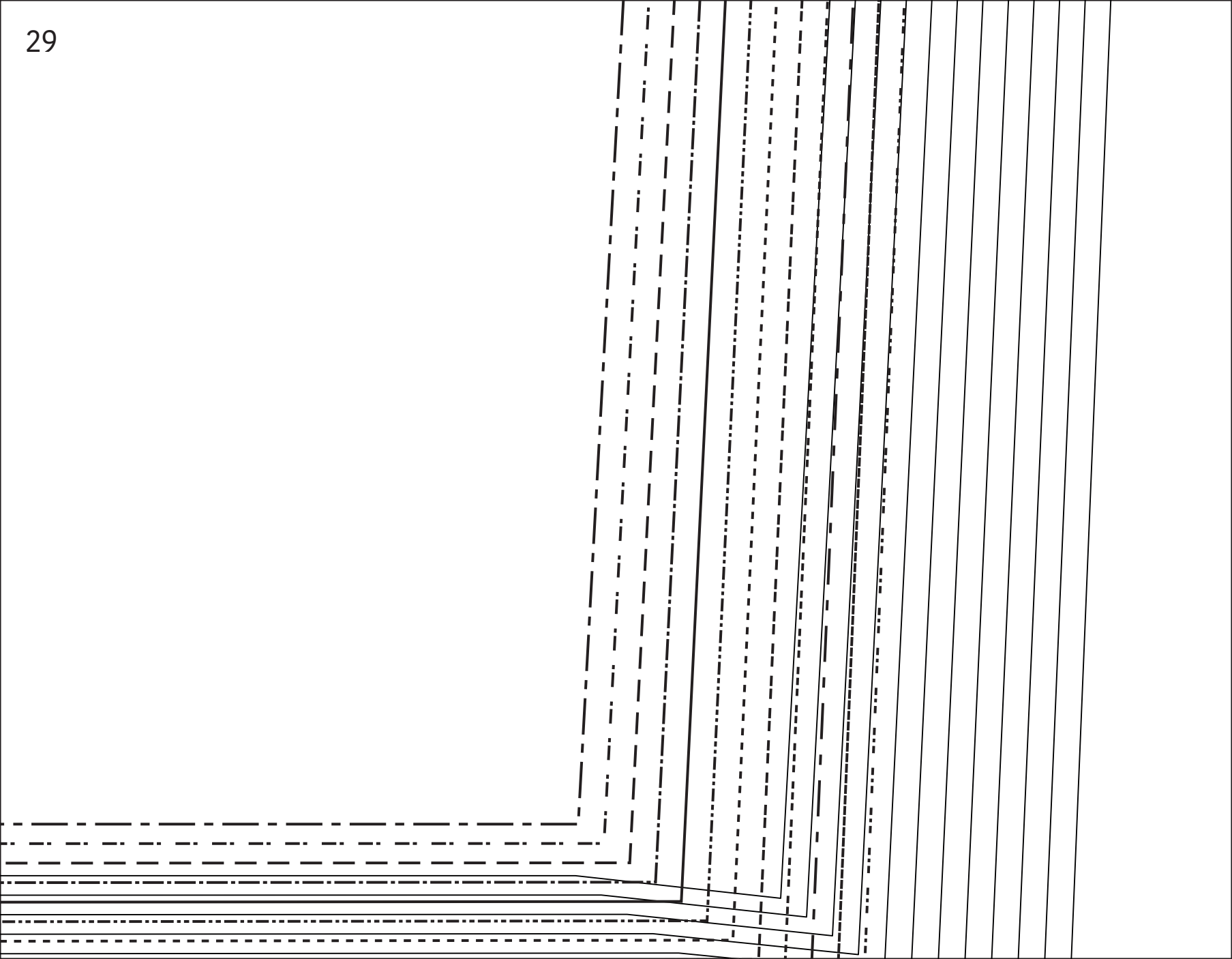

CATO - G



LA MAISON  
*Victor*

MR/MDS/CB



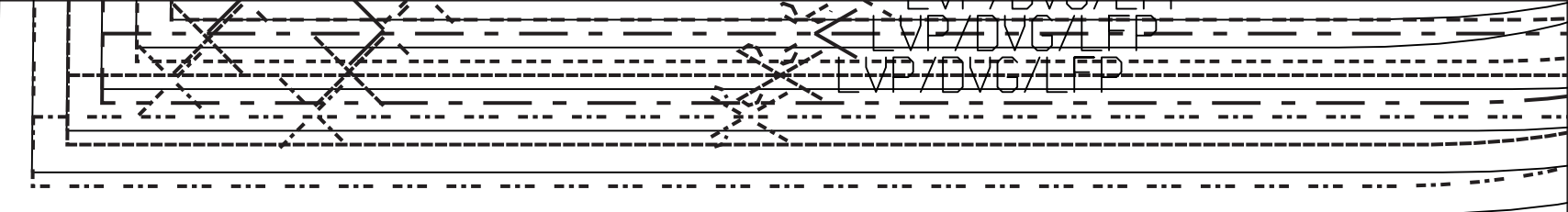

*Victor*  
LA MAISON

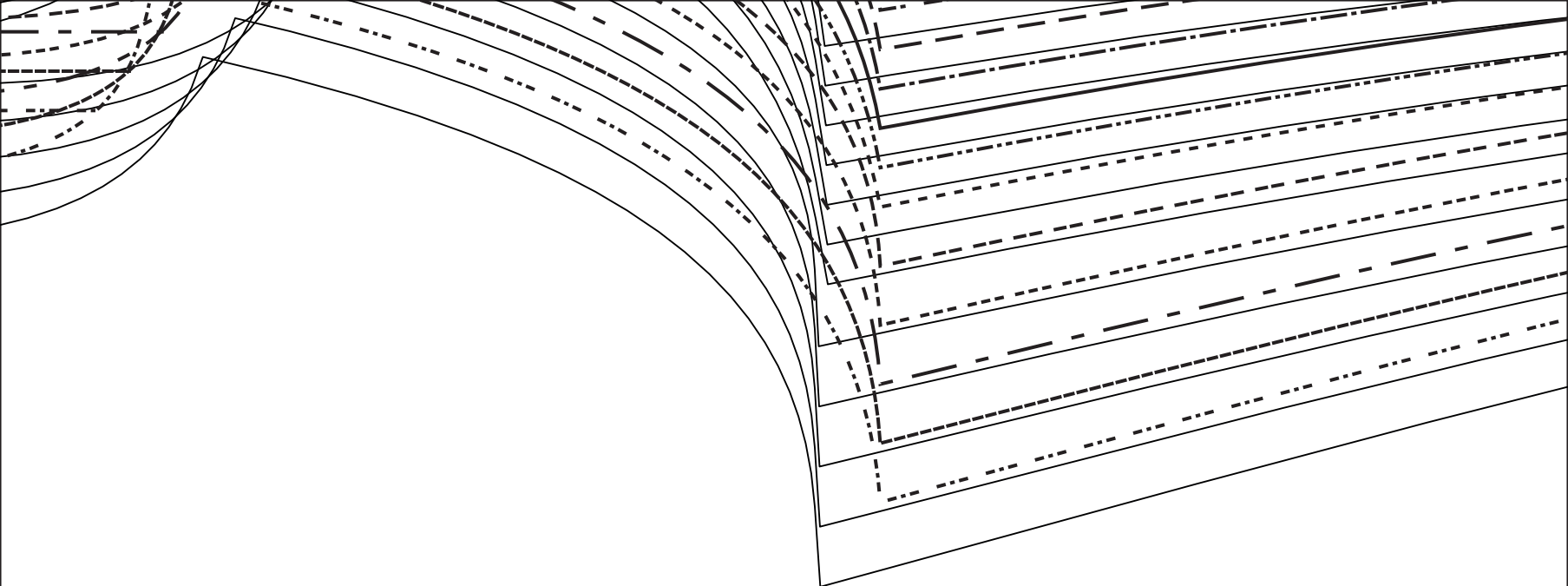

**CATO**

**D**





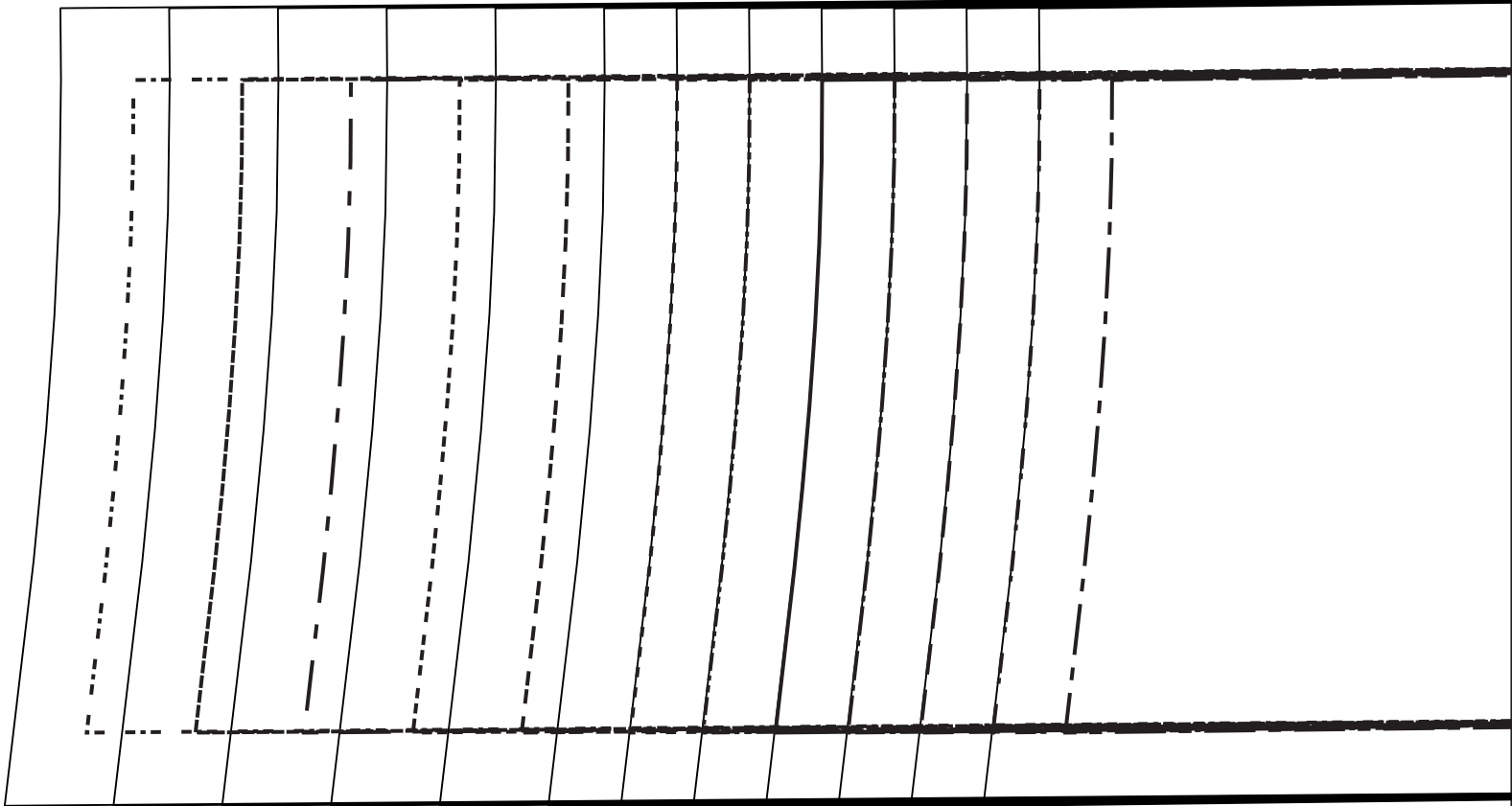
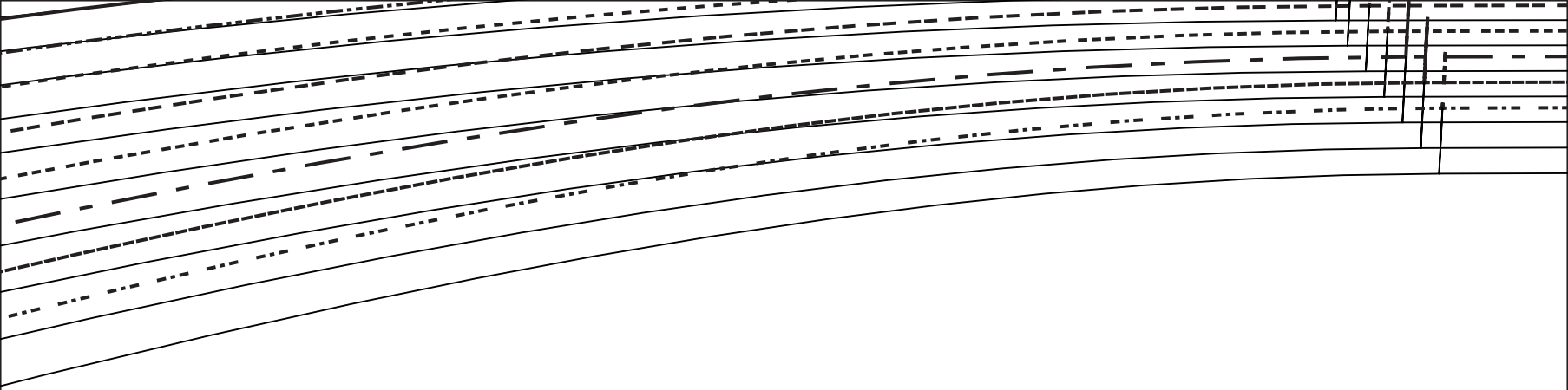

*Victor*  
LA MAISON

CATO - F



