

Miyo

Jurk / Robe / Dress

Maten / Tailles / Sizes:

.....	92
-----	98
- - - - -	104
- . - . -	110
- - - - -	116
- . - . -	122 / 128
—————	134 / 140
- . - . -	146 / 152
- . - . -	158 / 164
- - - - -	170 / 176

Patroondelen / Pièces du patron / Pattern pieces:

- A** voorpand boven / devant haut /
front panel top
- B** rugpand boven / dos haut /
back panel top
- C** voorpand onder / devant bas /
front panel bottom
- D** rugpand onder / dos bas /
back panel bottom
- E** zak / poche / pocket

Patroonschema / Schéma du Patron / Pattern Diagram / Übersichtsplan zum Zusammenkleben

1	2	3	4	5	6
7	8	9	10	11	12
13	14	15	16	17	18
19	20	21	X 22	X 23	X 24
25	26	27			

Controlevierkant / Carré de controle / Test square / Kontrollquadrat

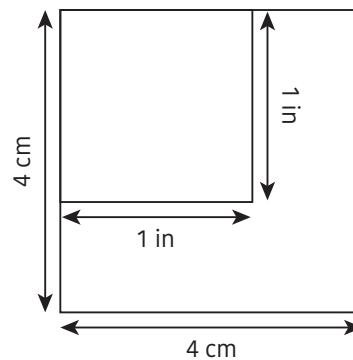

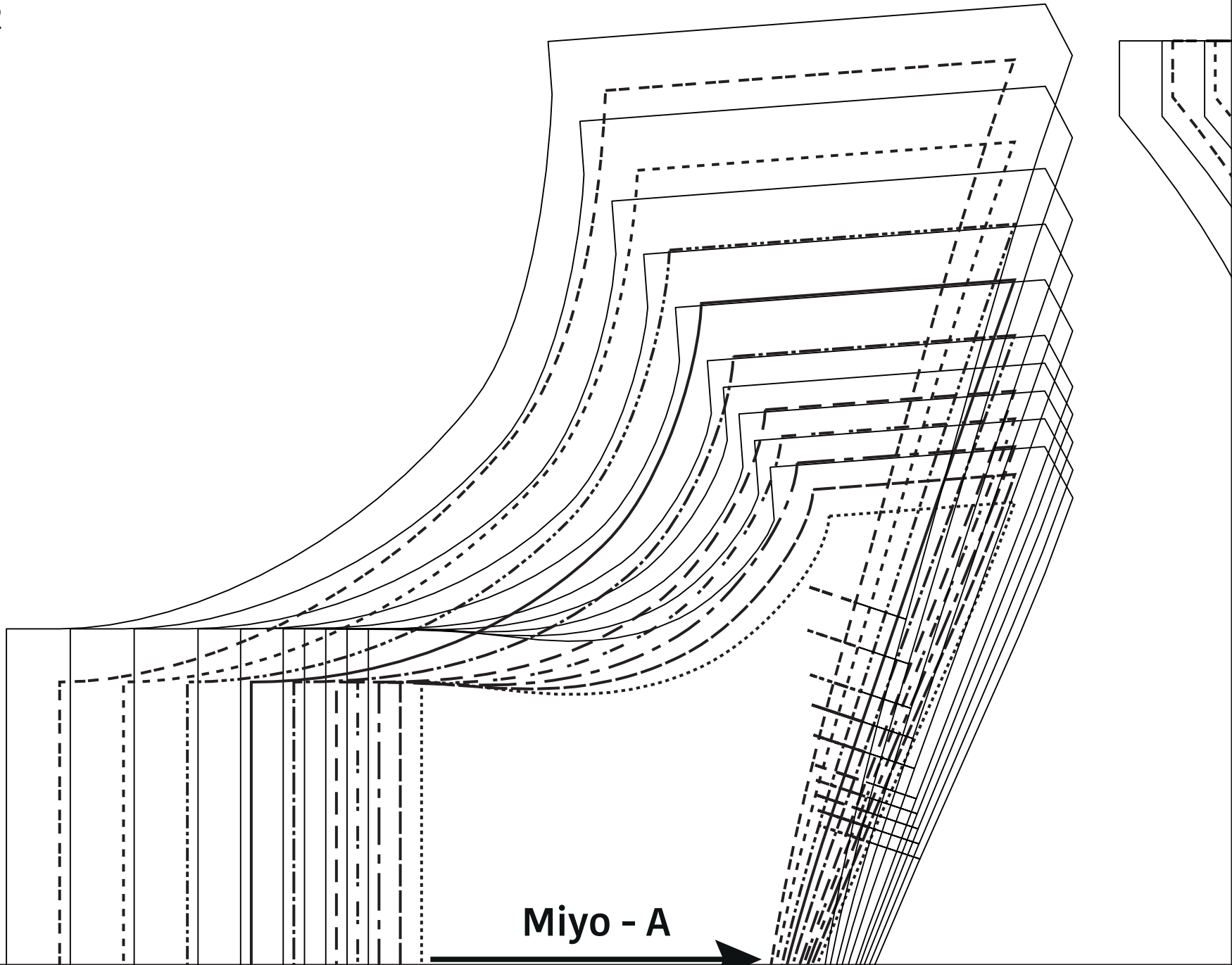

Miyo - A

MR/MDS/CB

Miyo - B



LA MAISON
Victor

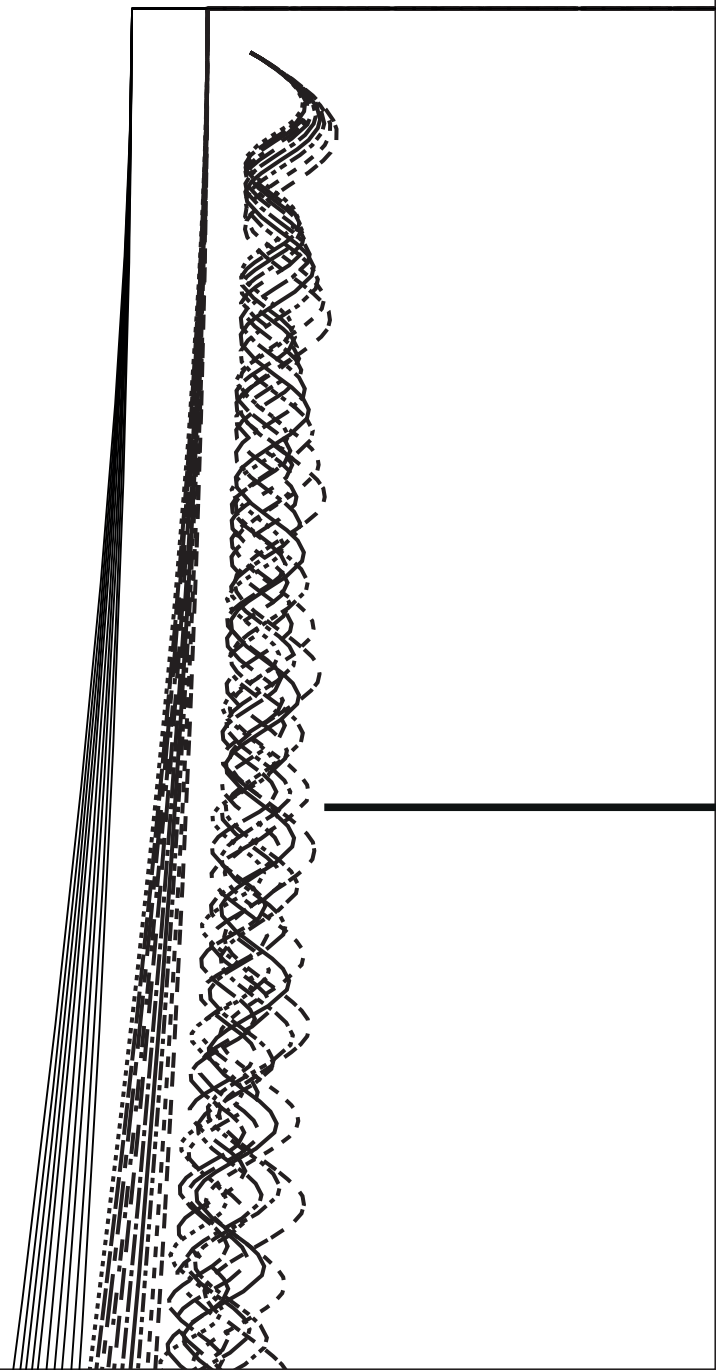
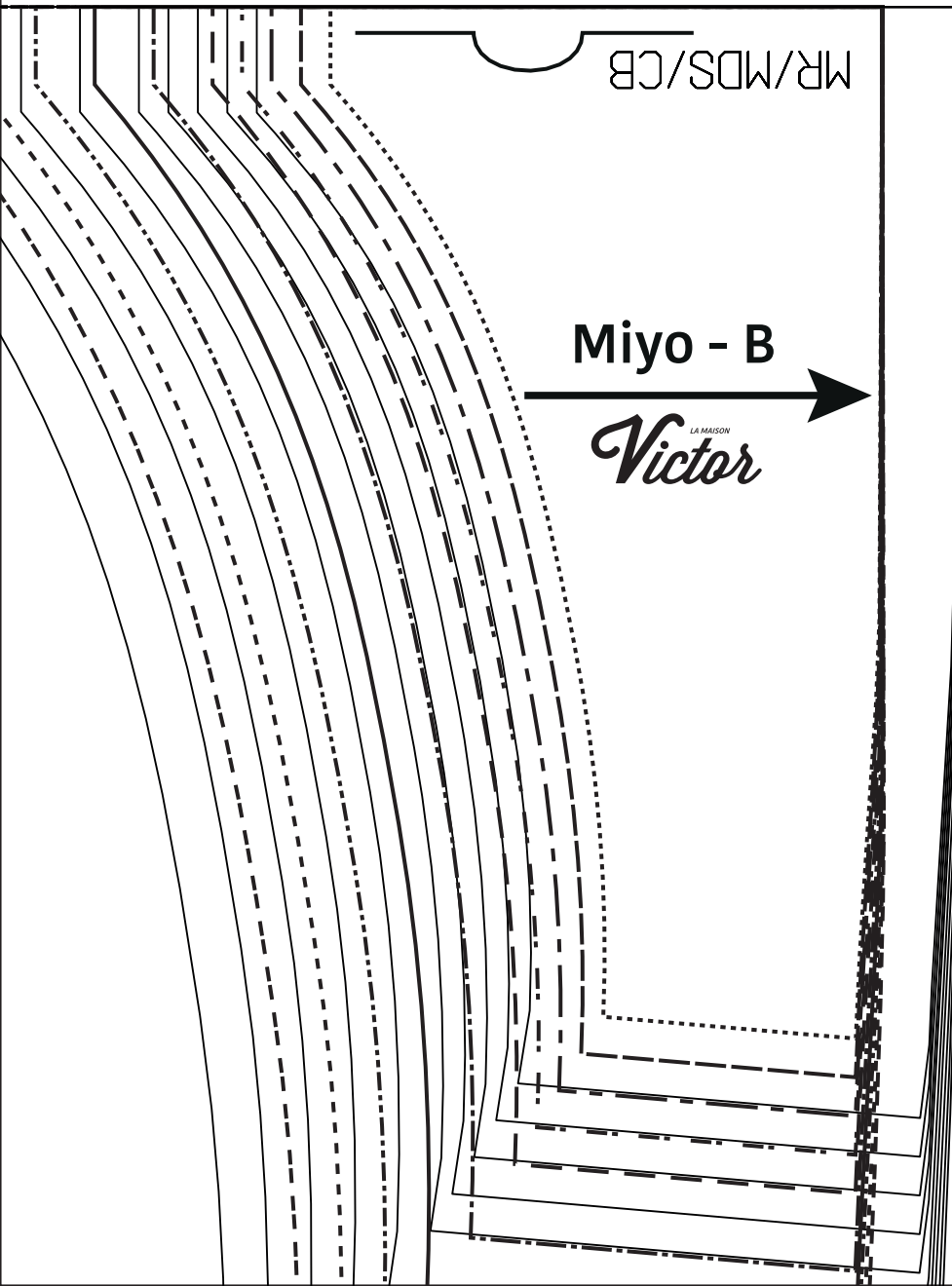



Miyo - D

LA MAISON
Victor

5

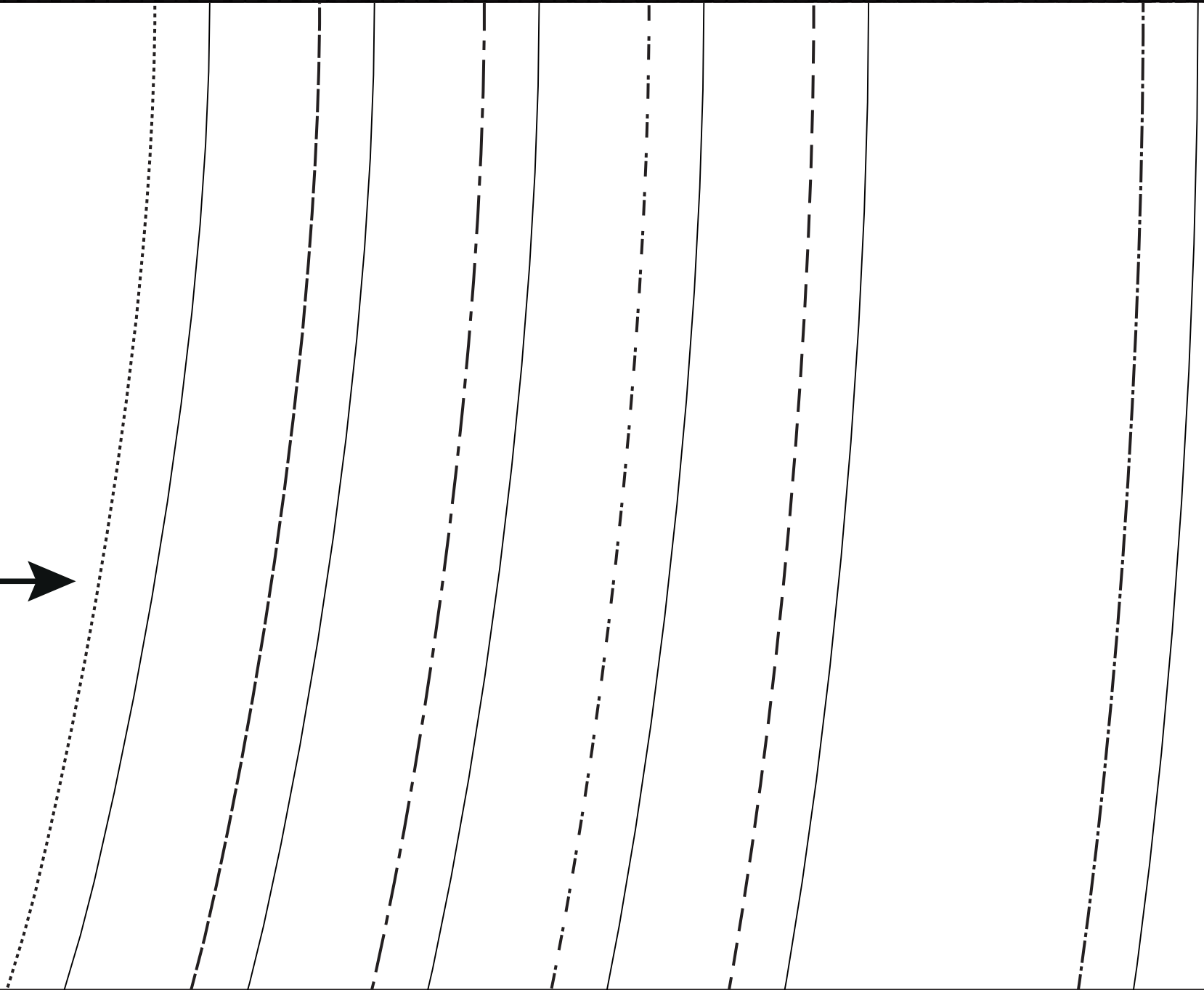

--	--	--	--	--	--

7

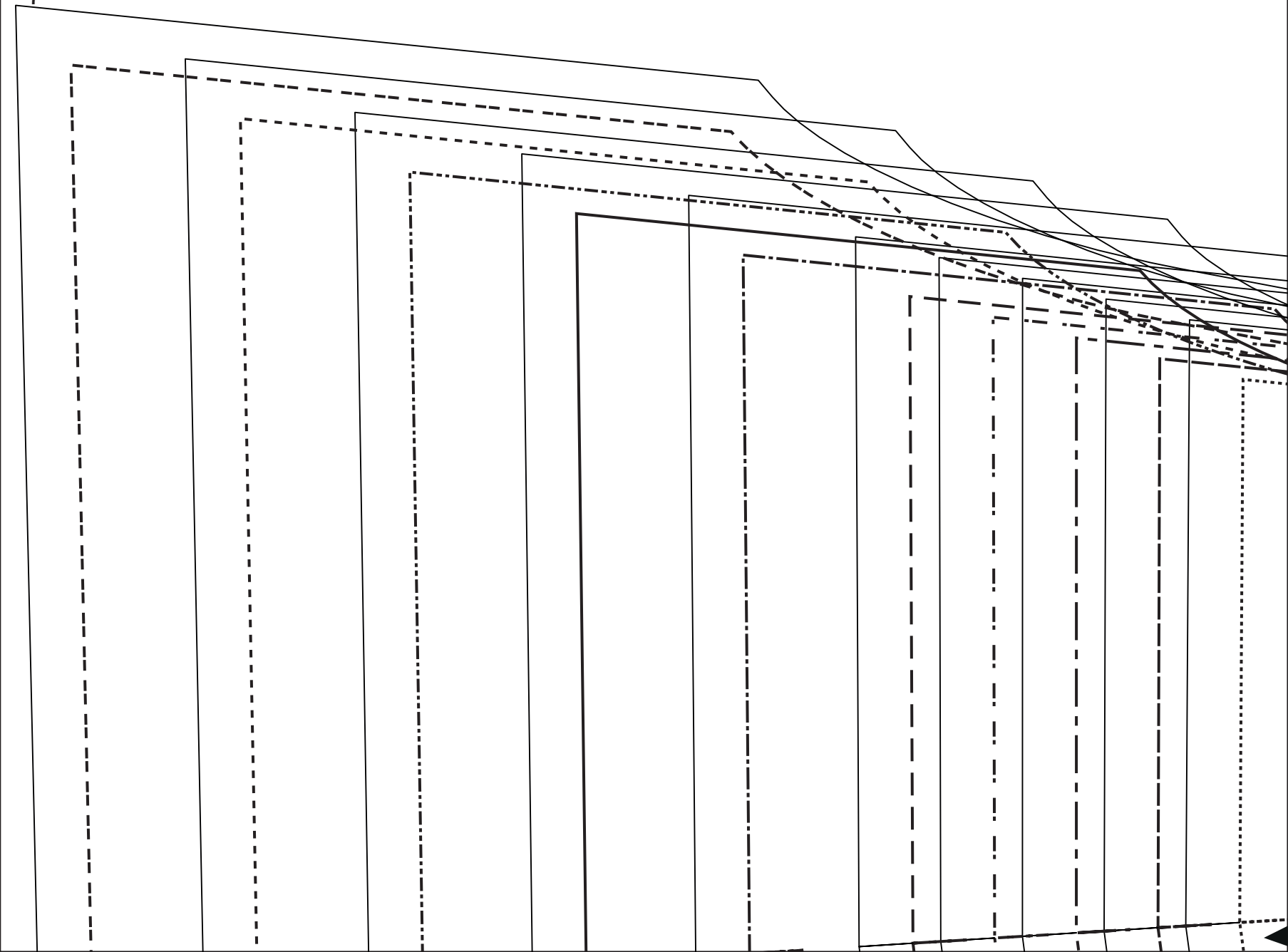

8

LA MAISON
Victor

MV/MDV/CF

Victor
LA MAISON

MIYO - L

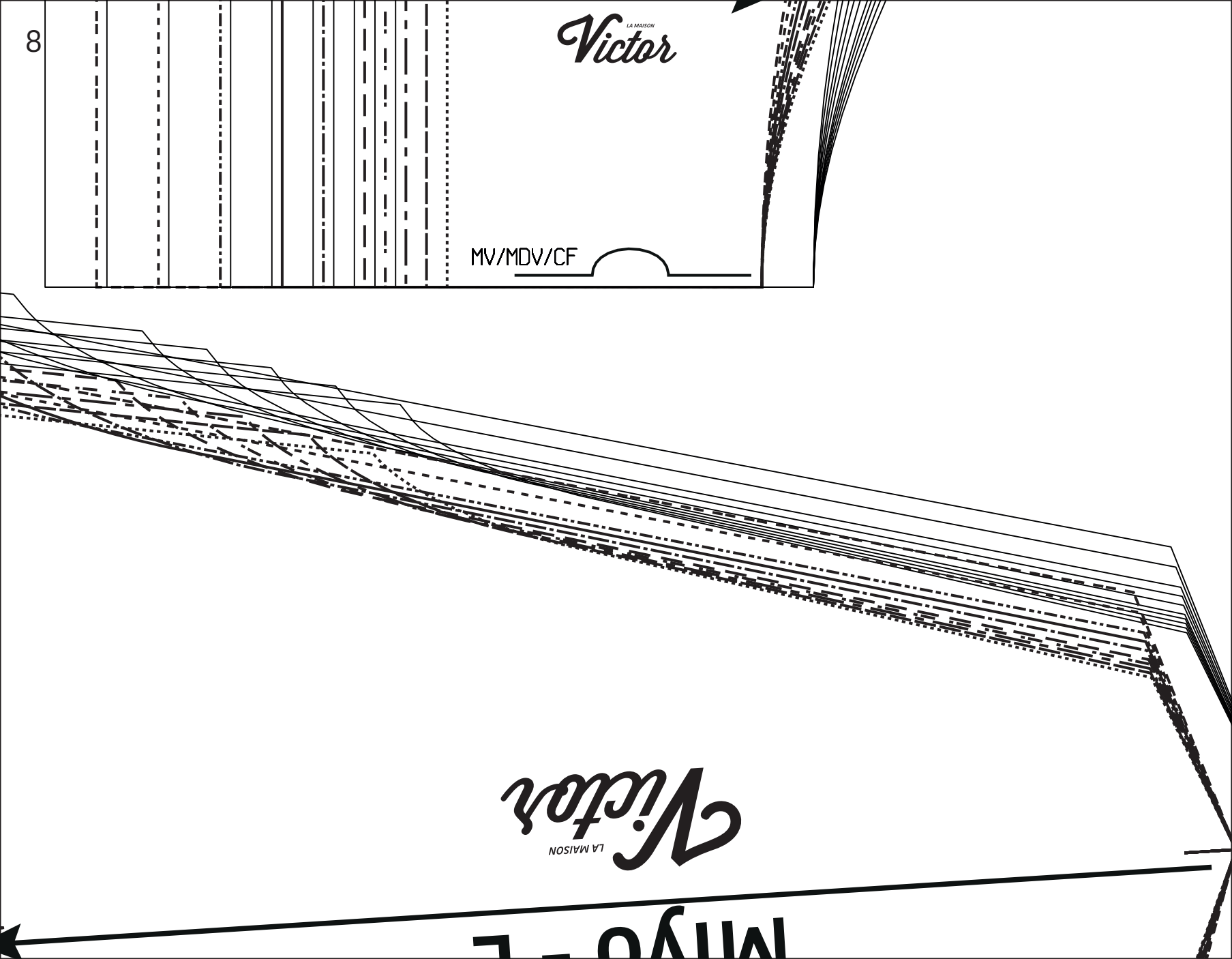

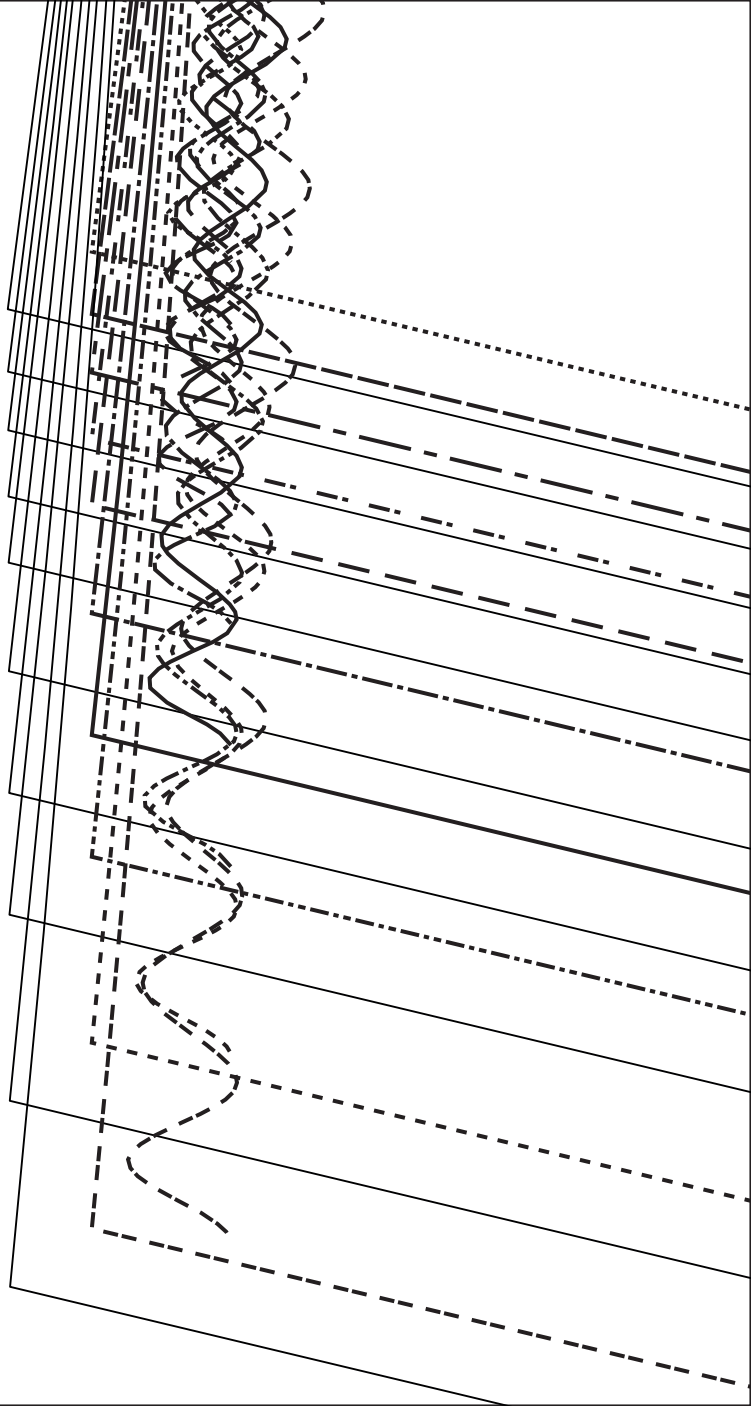
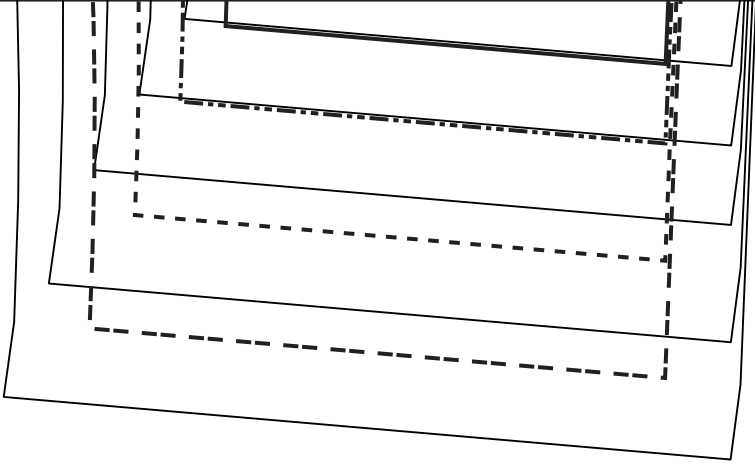

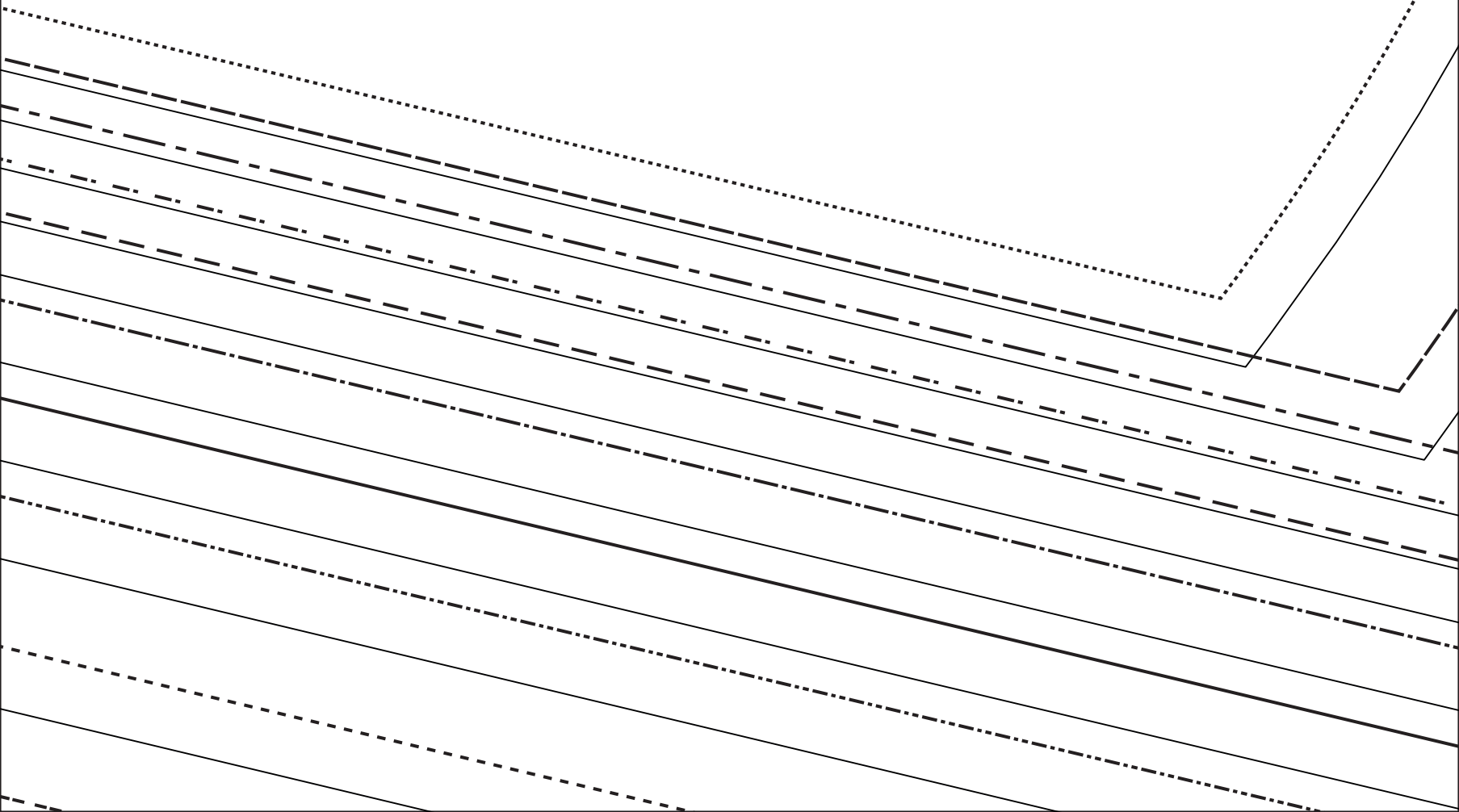

11

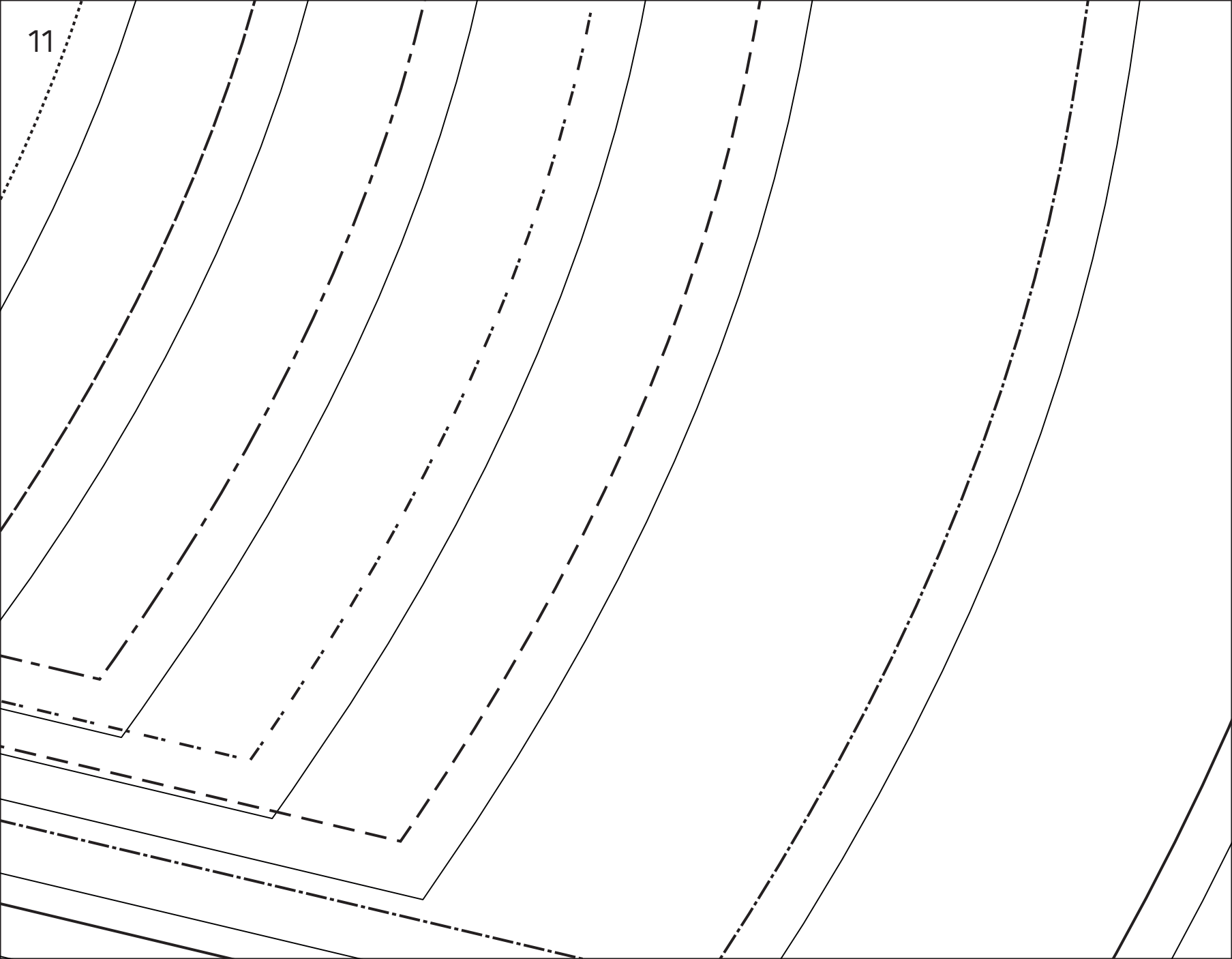

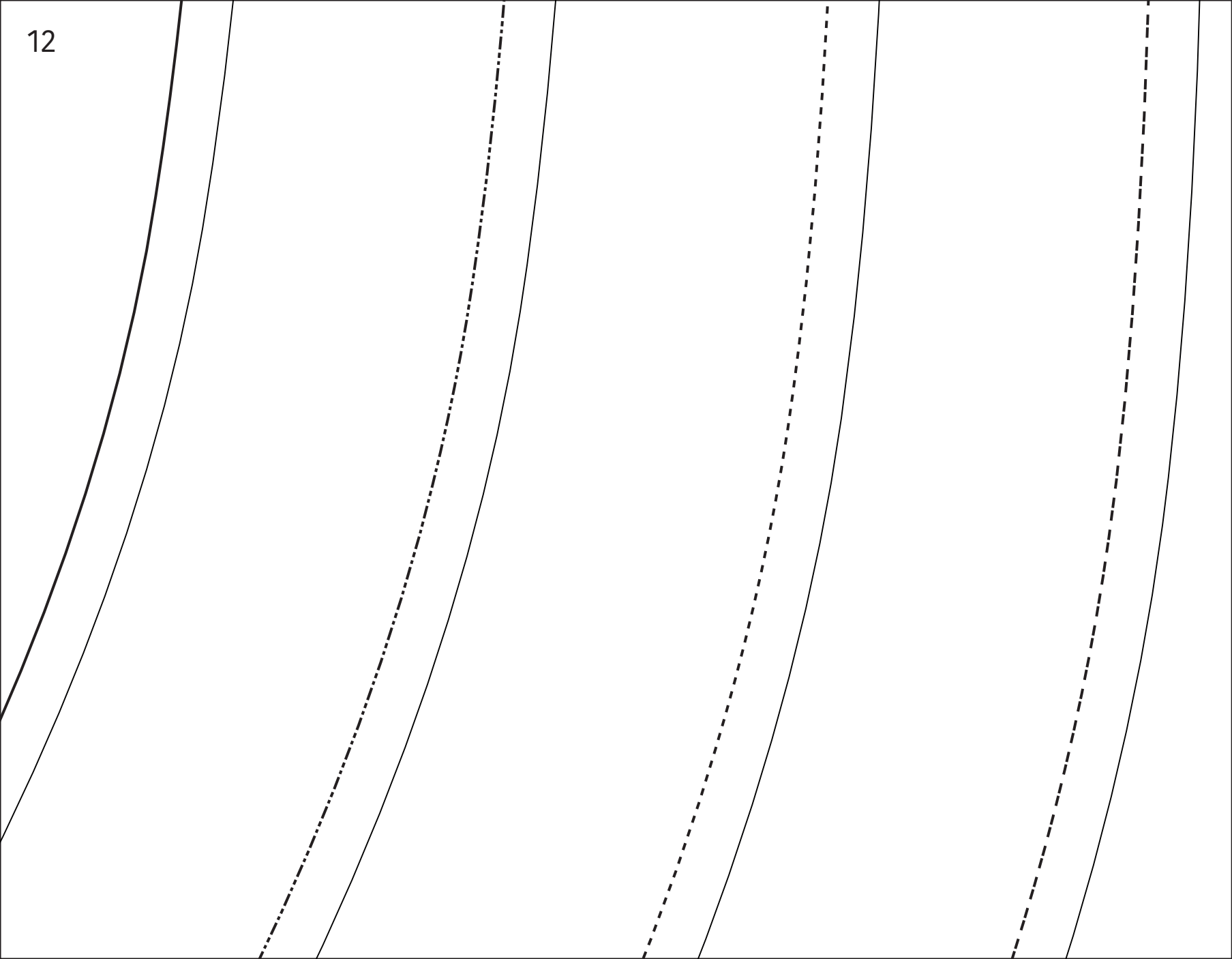

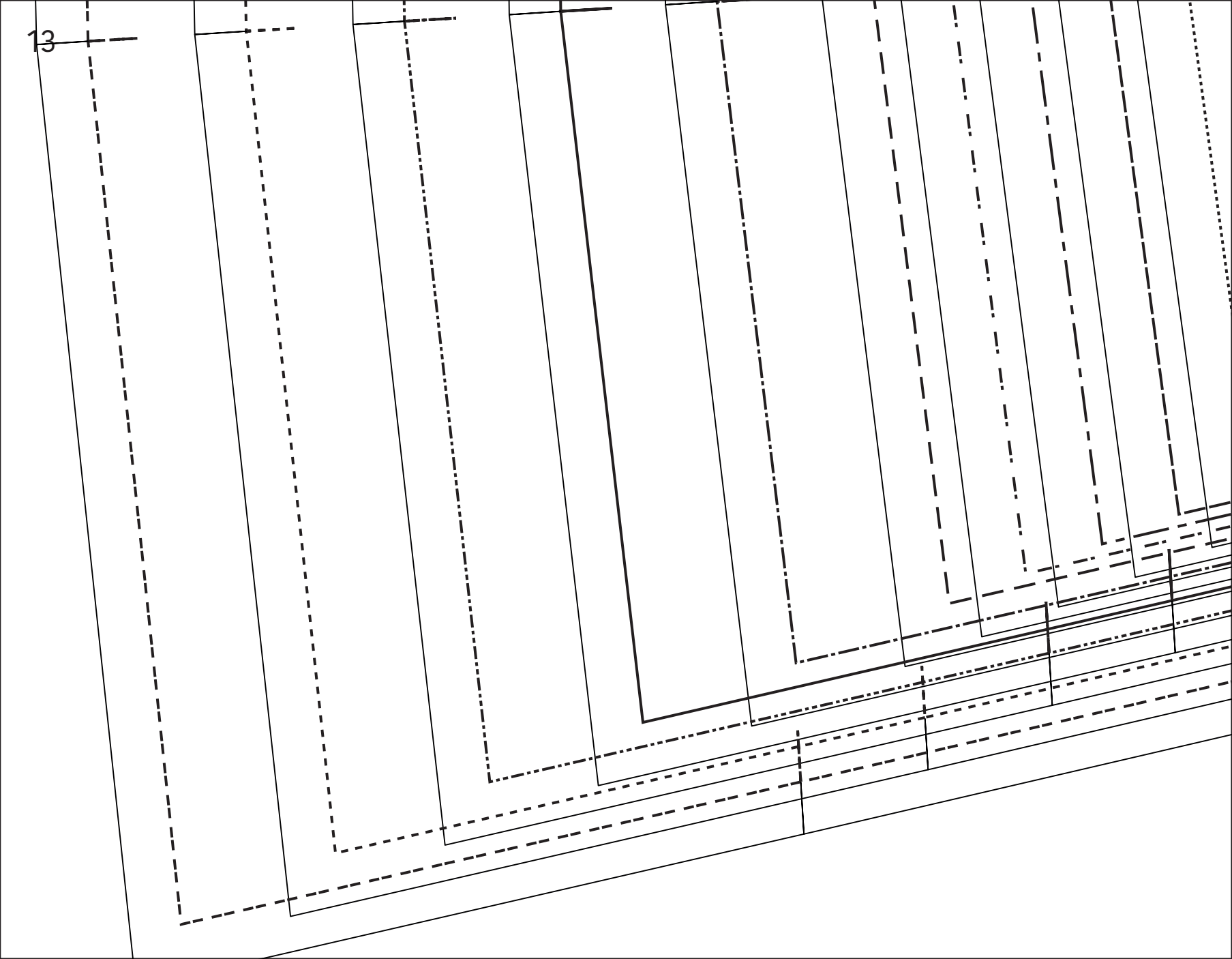

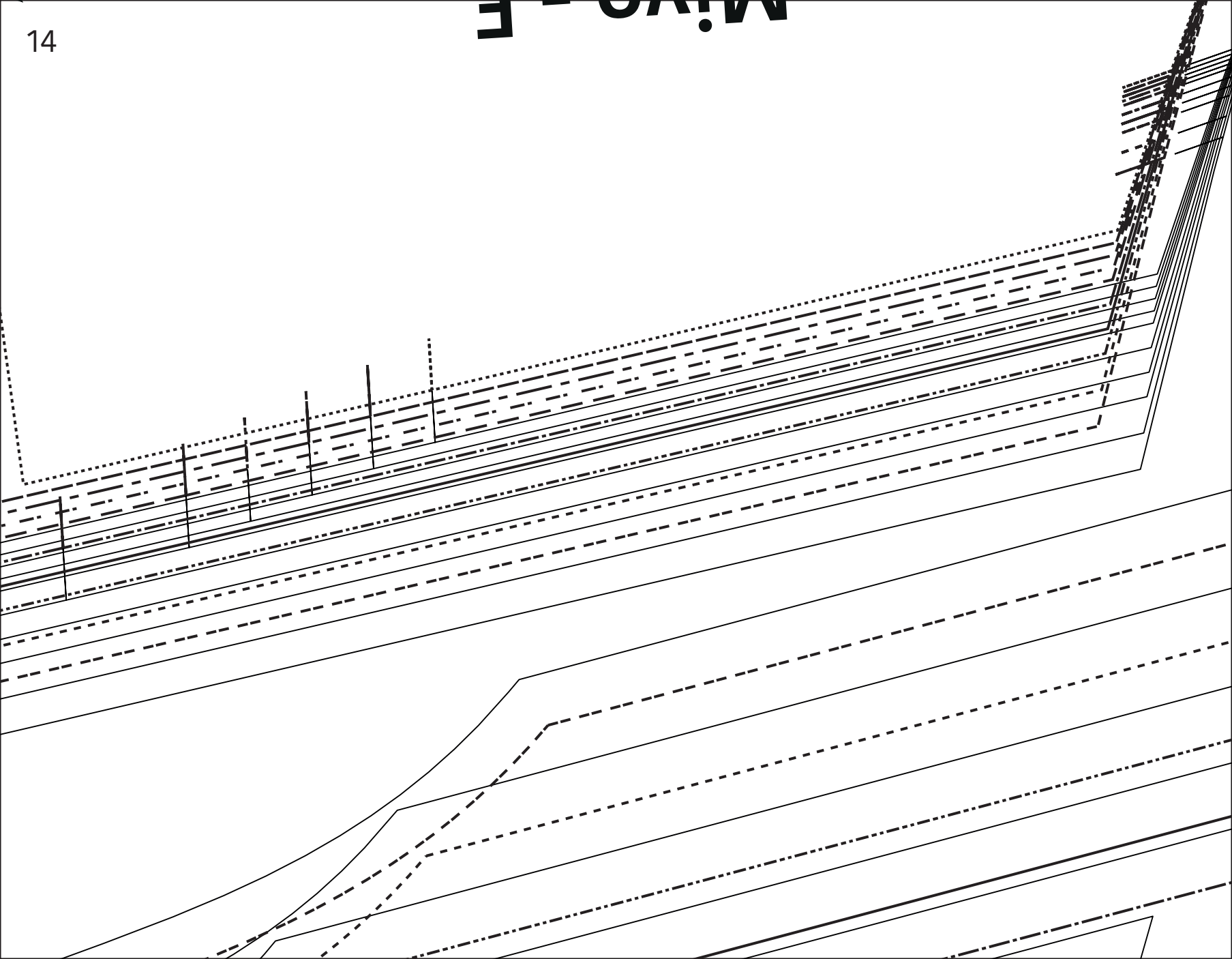

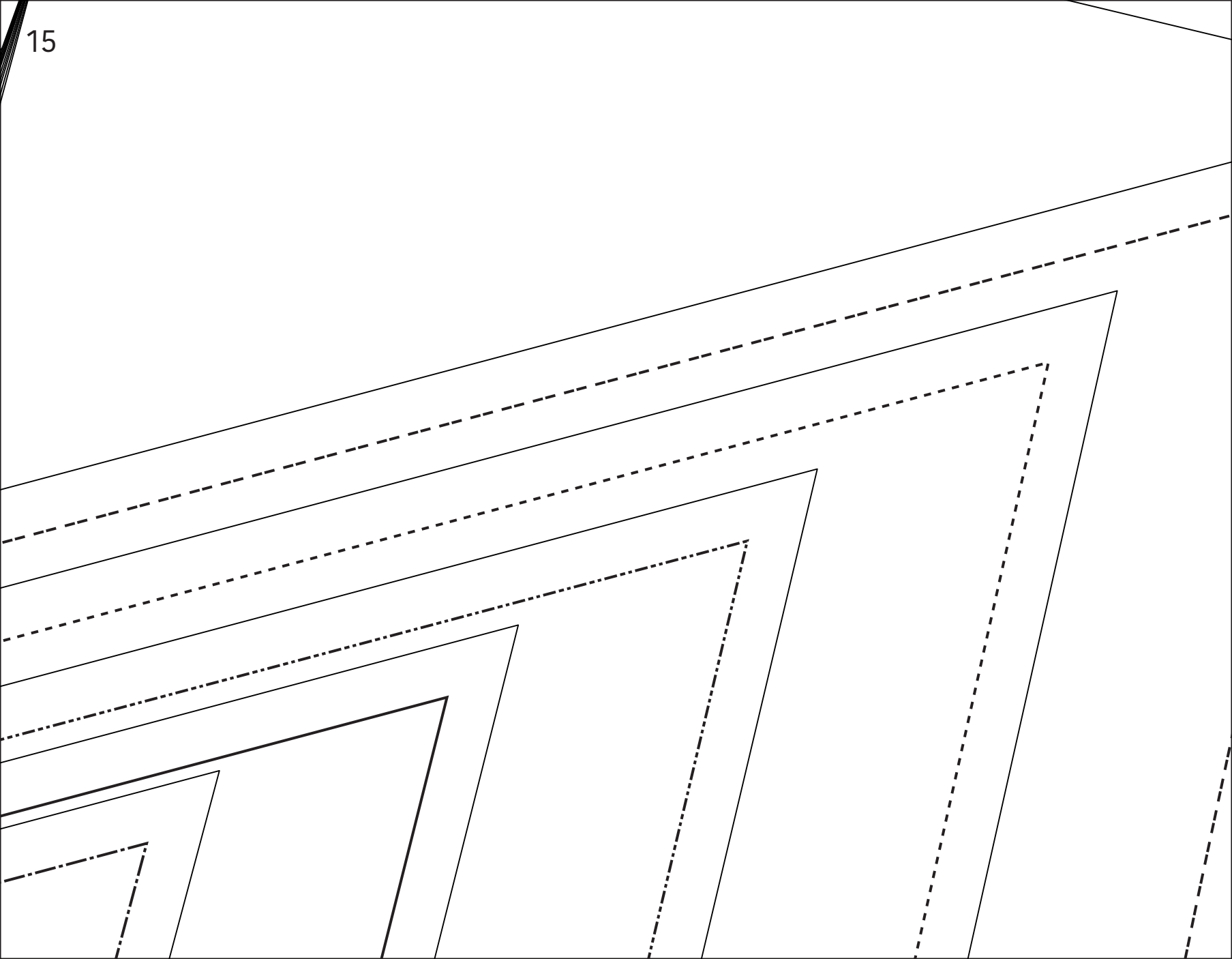

16

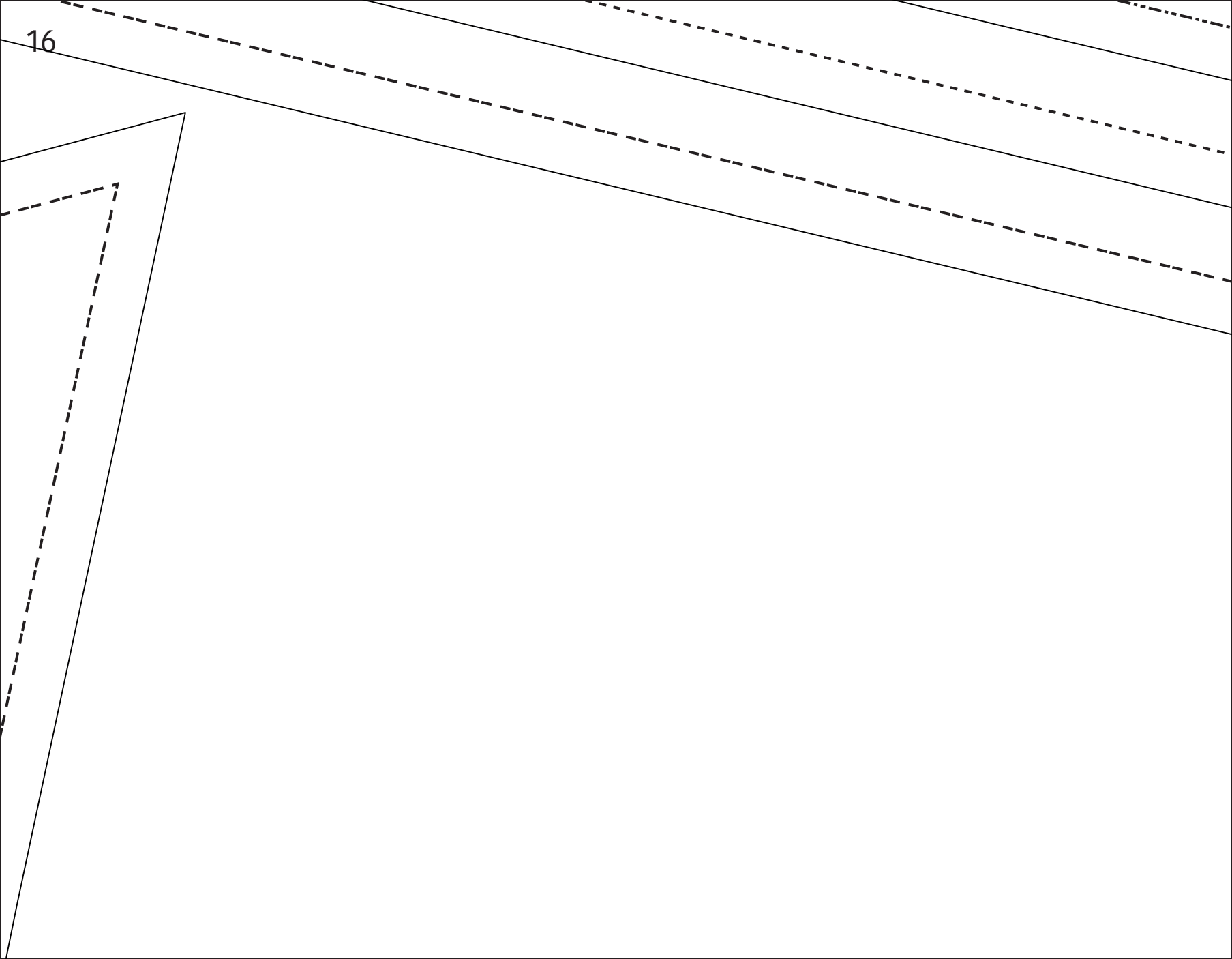

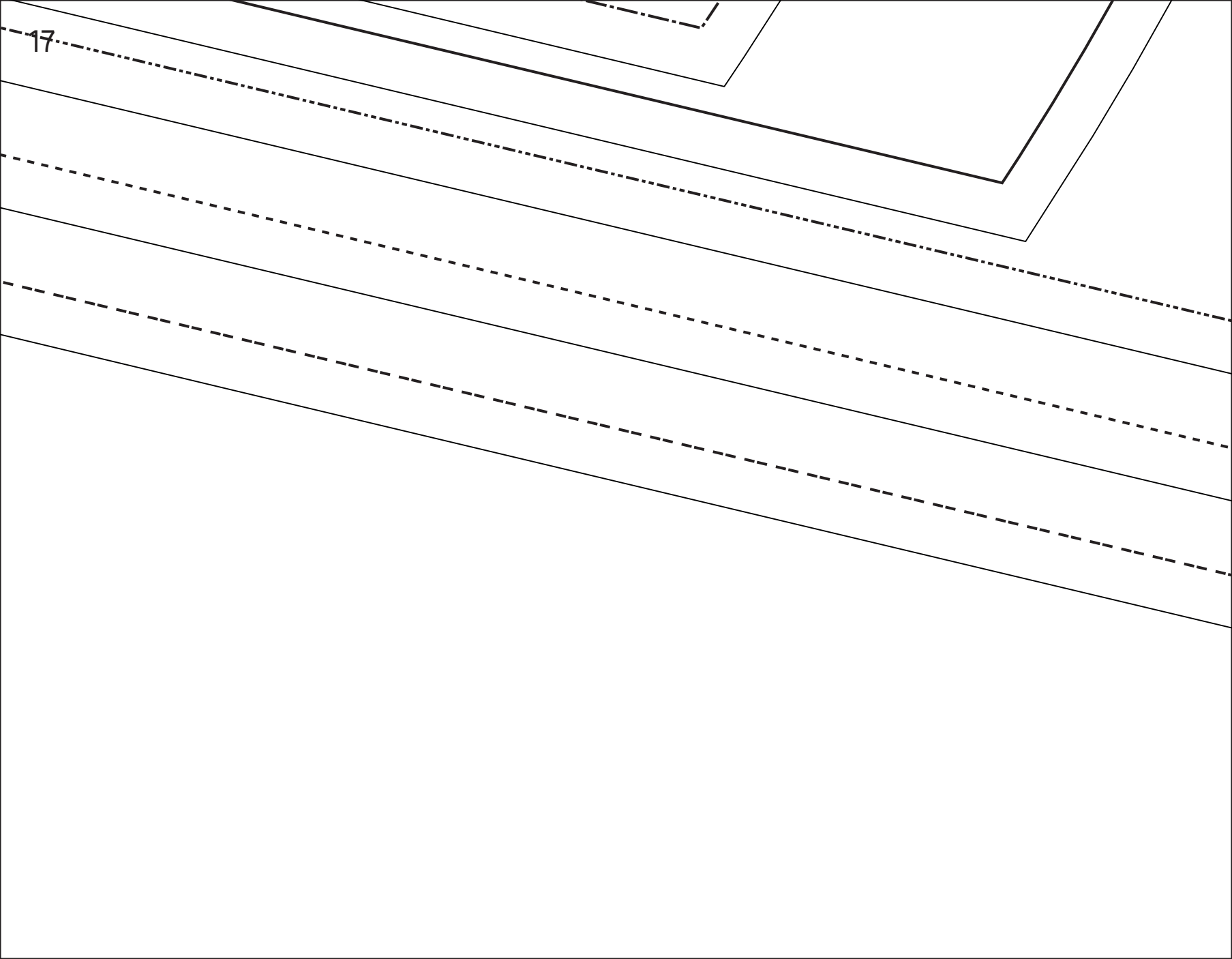

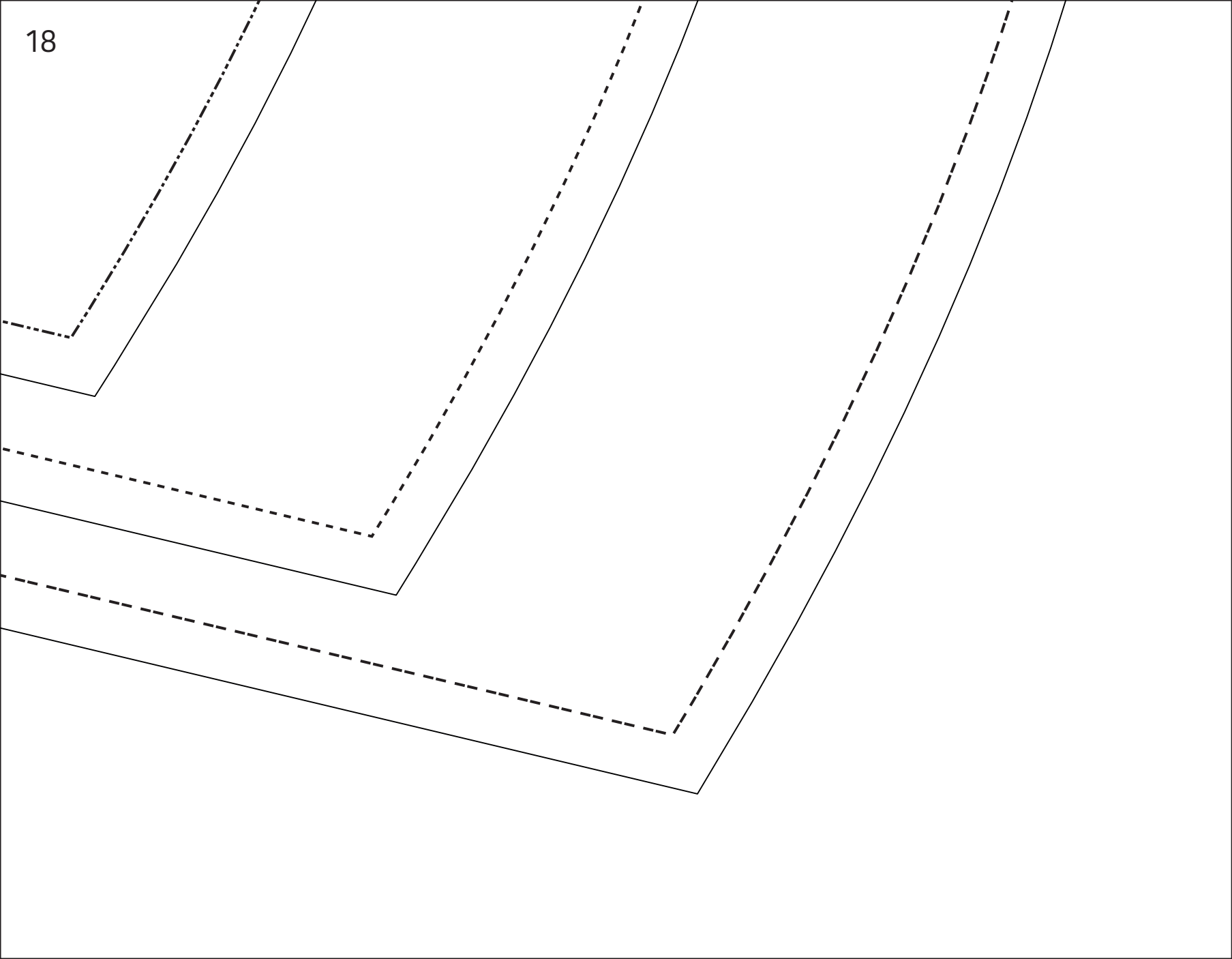

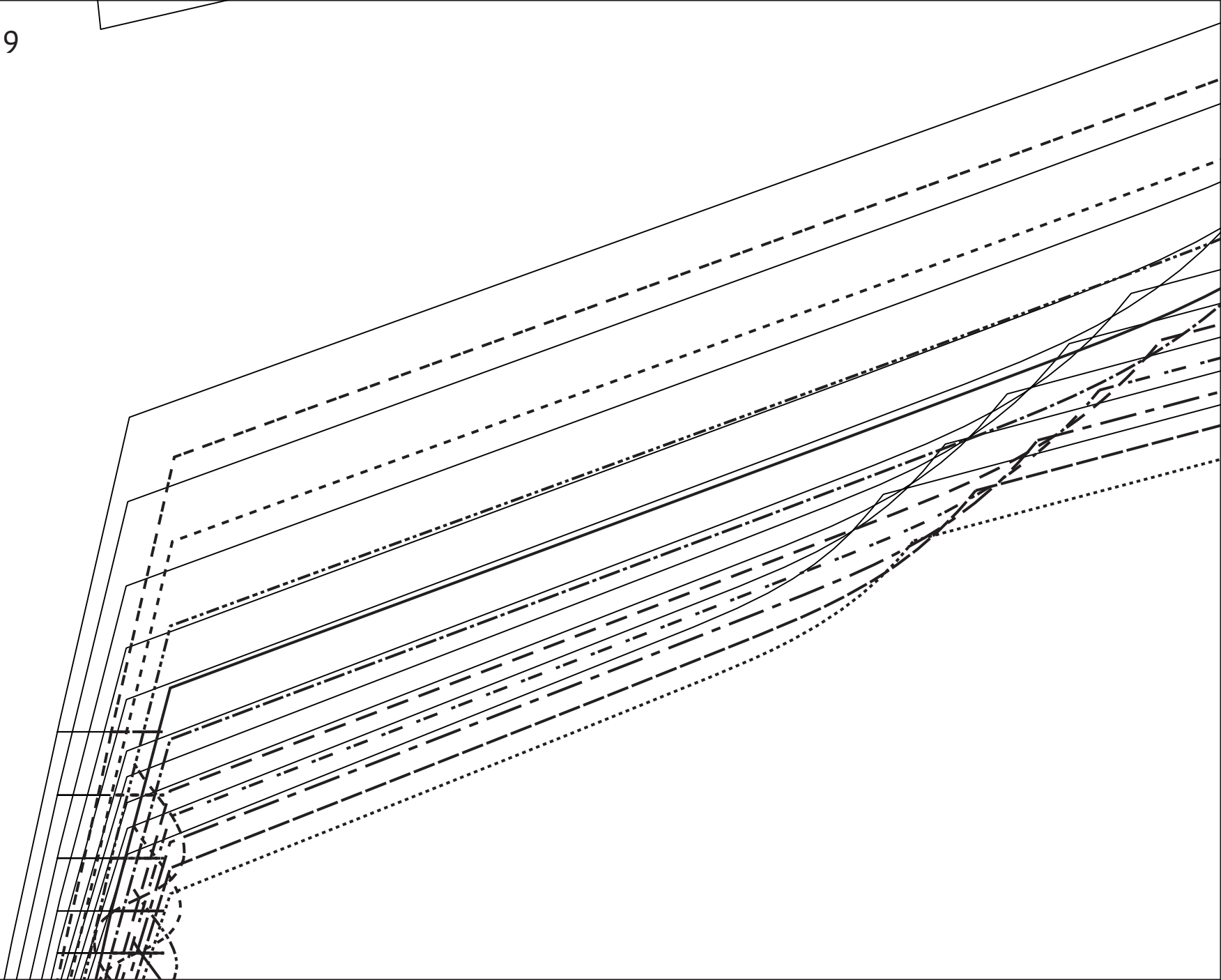

20

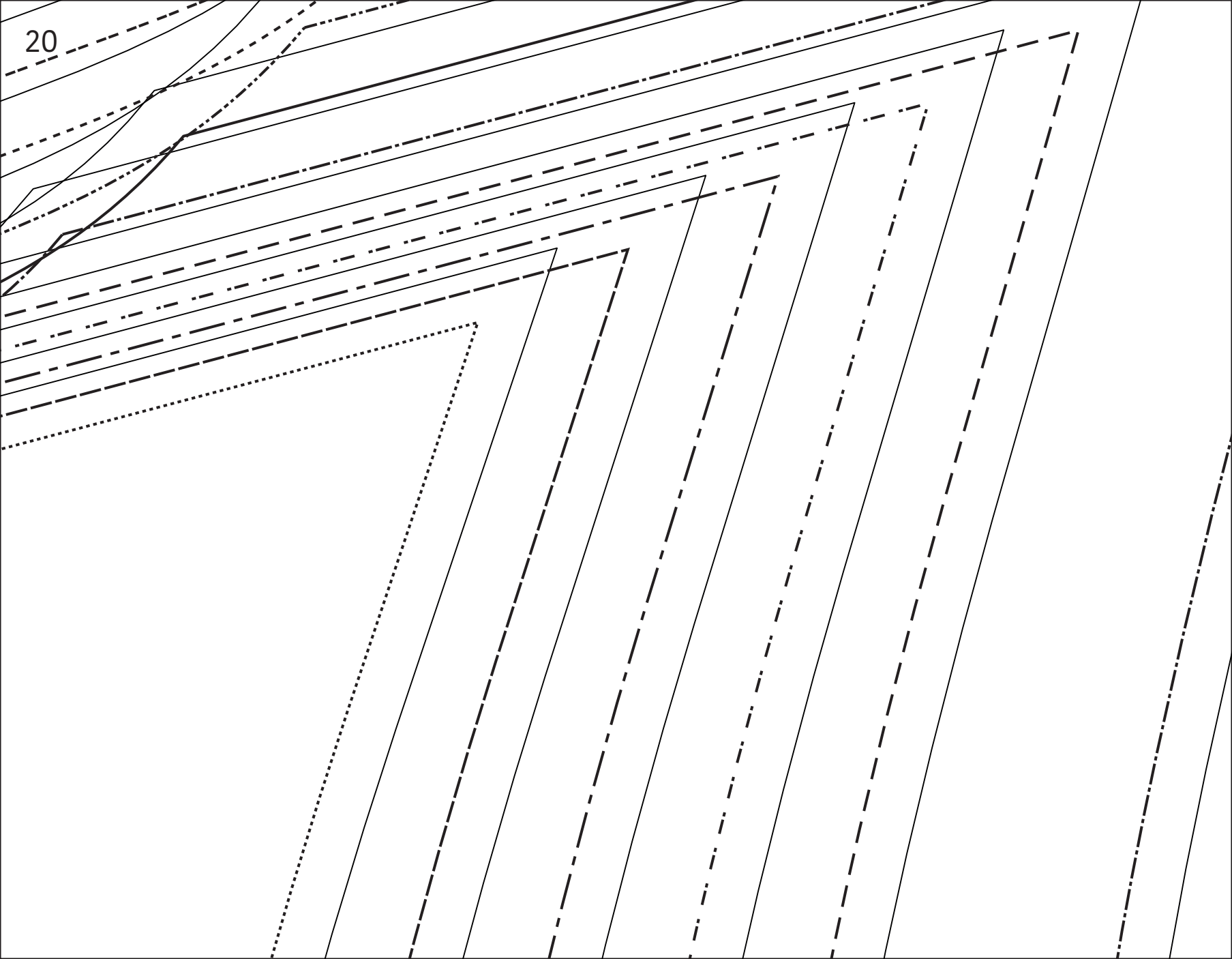

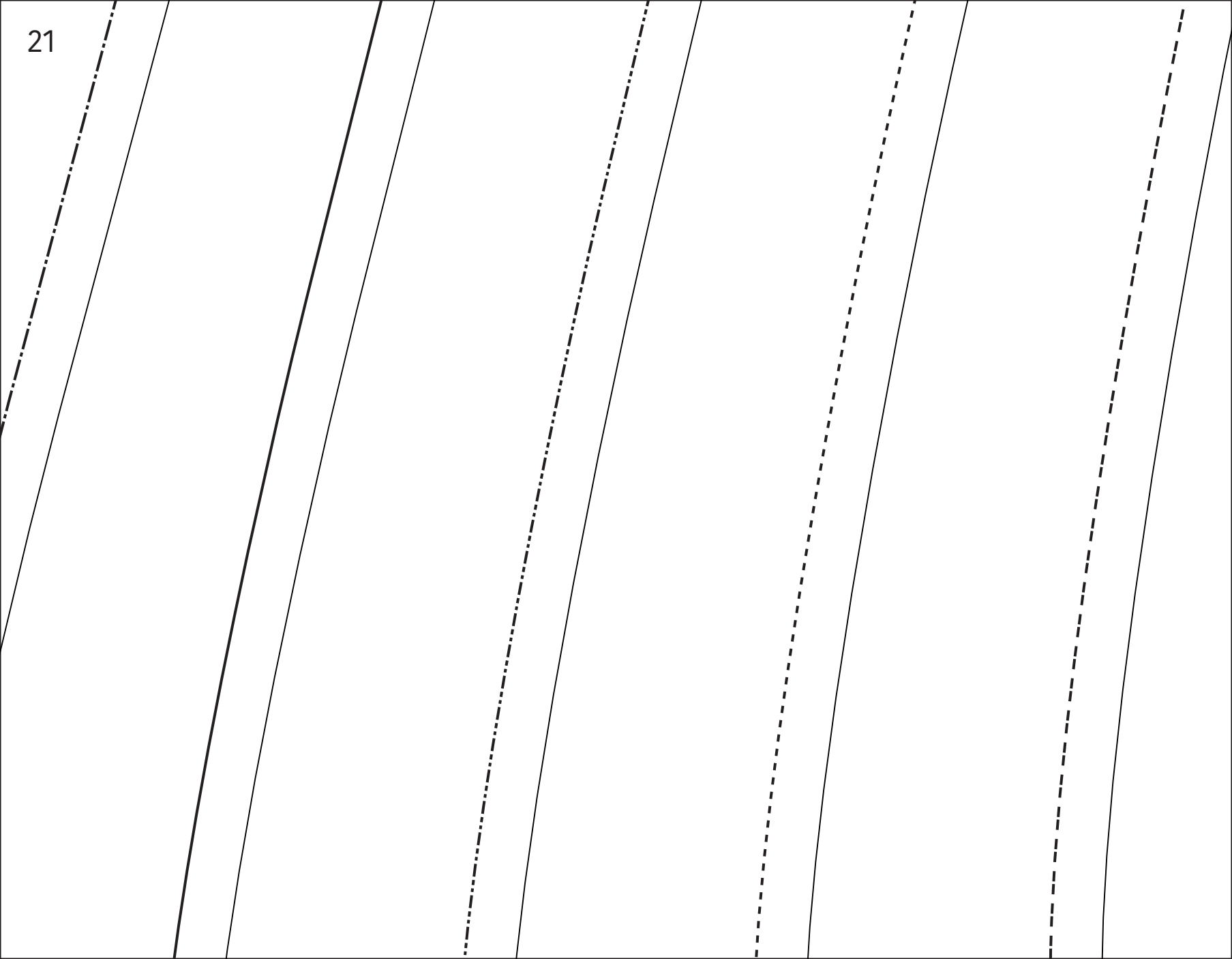

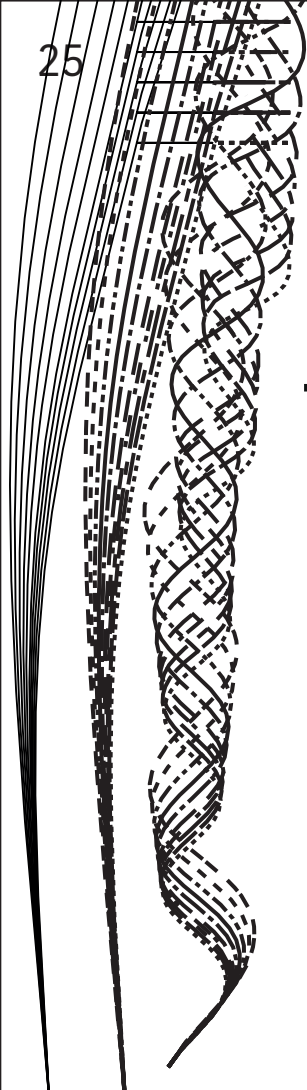

Miyo - C

LA MAISON
Victor

MV/MDV/CF



