

Dalia

Jurk / Robe / Dress Blouse

Maten / Tailles / Sizes:

| | |
|-------------|-----------|
| | 92 |
| ----- | 98 |
| ----- | 104 |
| - - - - - | 110 |
| ----- | 116 |
| - . - . - . | 122 / 128 |
| ===== | 134 / 140 |
| | 146 / 152 |
| - - - - - | 158 / 164 |
| - - - - - | 170 / 176 |

Patroondelen / Pièces du patron / Pattern pieces:

- A** voorpand / devant / front panel
- B** rugpand / dos / back panel
- C** kraag / col / collar
- D** biaisband hals rechts / ruban en
biais col droite / bias tape neck right
- E** biaisband hals links / ruban en biais
col gauche / bias tape neck left
- F** mouw / manche / sleeve
- G** bies mouwsplit / liseré fente manche /
sleeve trim split
- H** polsboord / bord manchette / cuff

Patroonschema / Schéma du Patron / Pattern Diagram / Übersichtsplan zum Zusammenkleben

| | | | | | |
|----|----|----|----|----|----|
| 1 | 2 | 3 | 4 | 5 | 6 |
| 7 | 8 | 9 | 10 | 11 | 12 |
| 13 | 14 | 15 | 16 | 17 | 18 |
| 19 | 20 | 21 | 22 | 23 | 24 |
| 25 | 26 | | | | |

Controlevierkant / Carré de controle / Test square / Kontrollquadrat

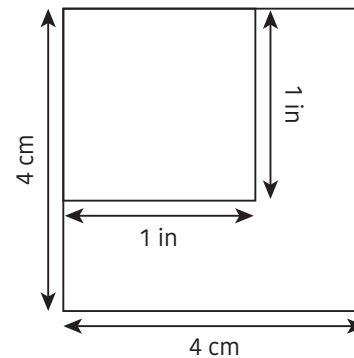

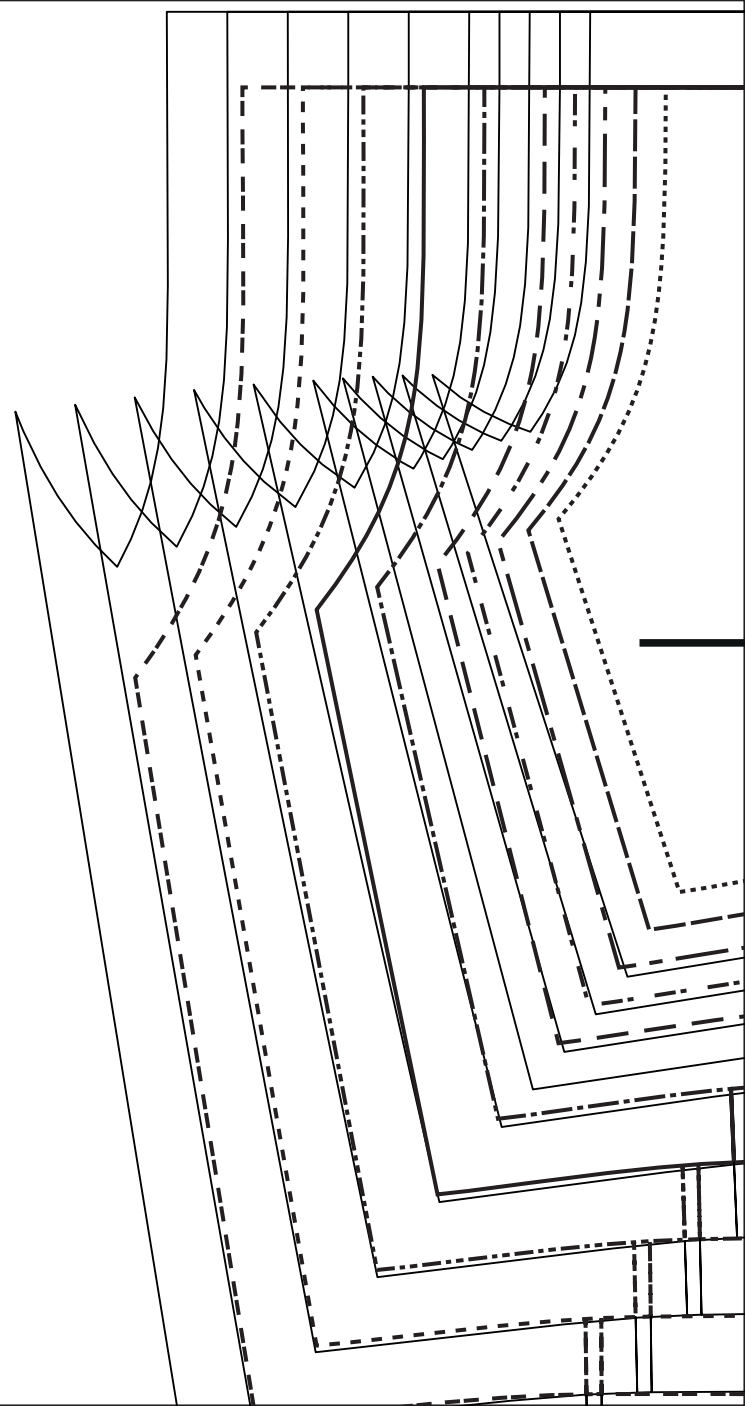

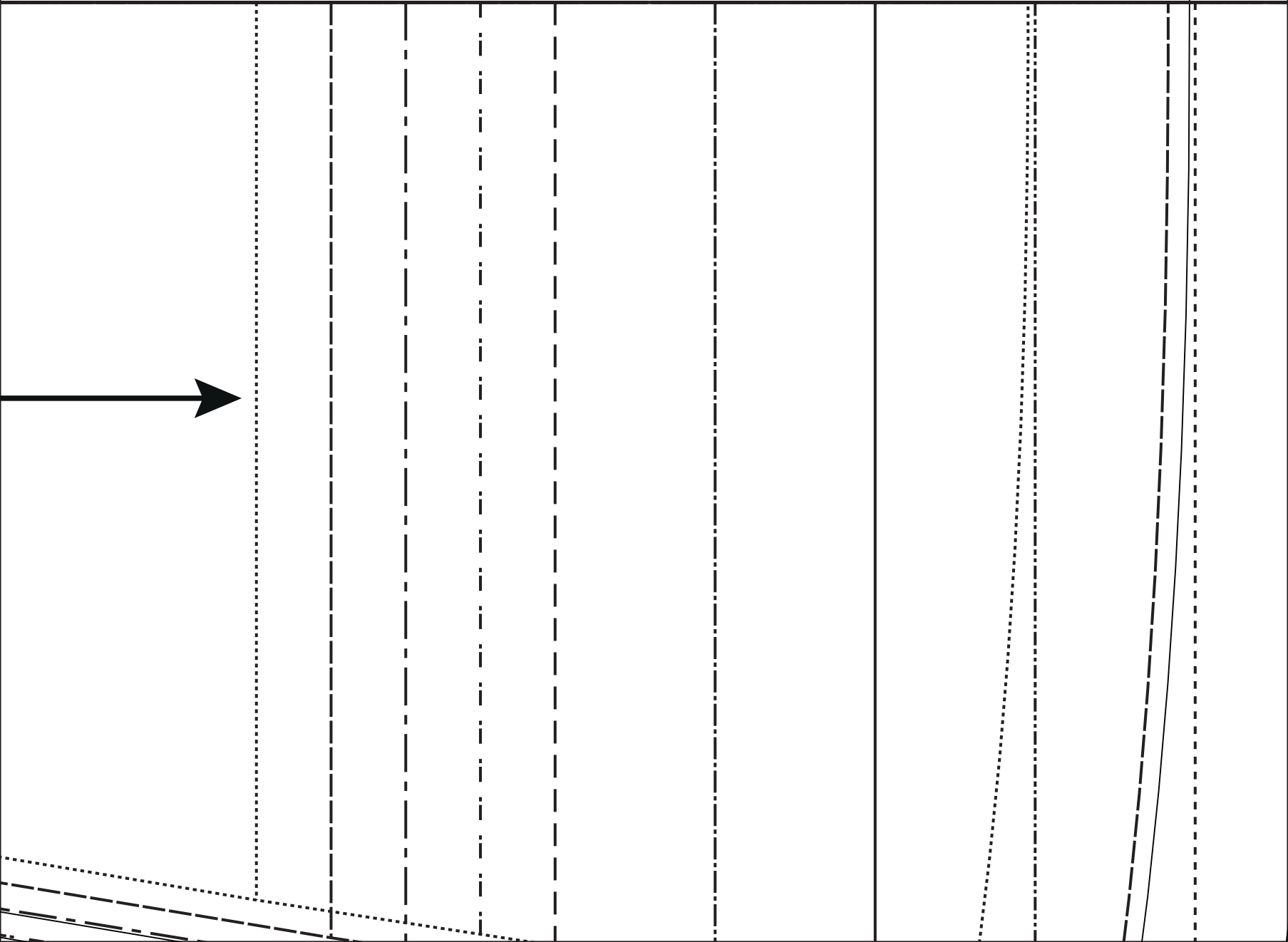

| | | | | | | |
|--|--|--|--|--|--|--|
| | | | | | | |
|--|--|--|--|--|--|--|

| | | | |
|--|--|--|--|
| | | | |
|--|--|--|--|

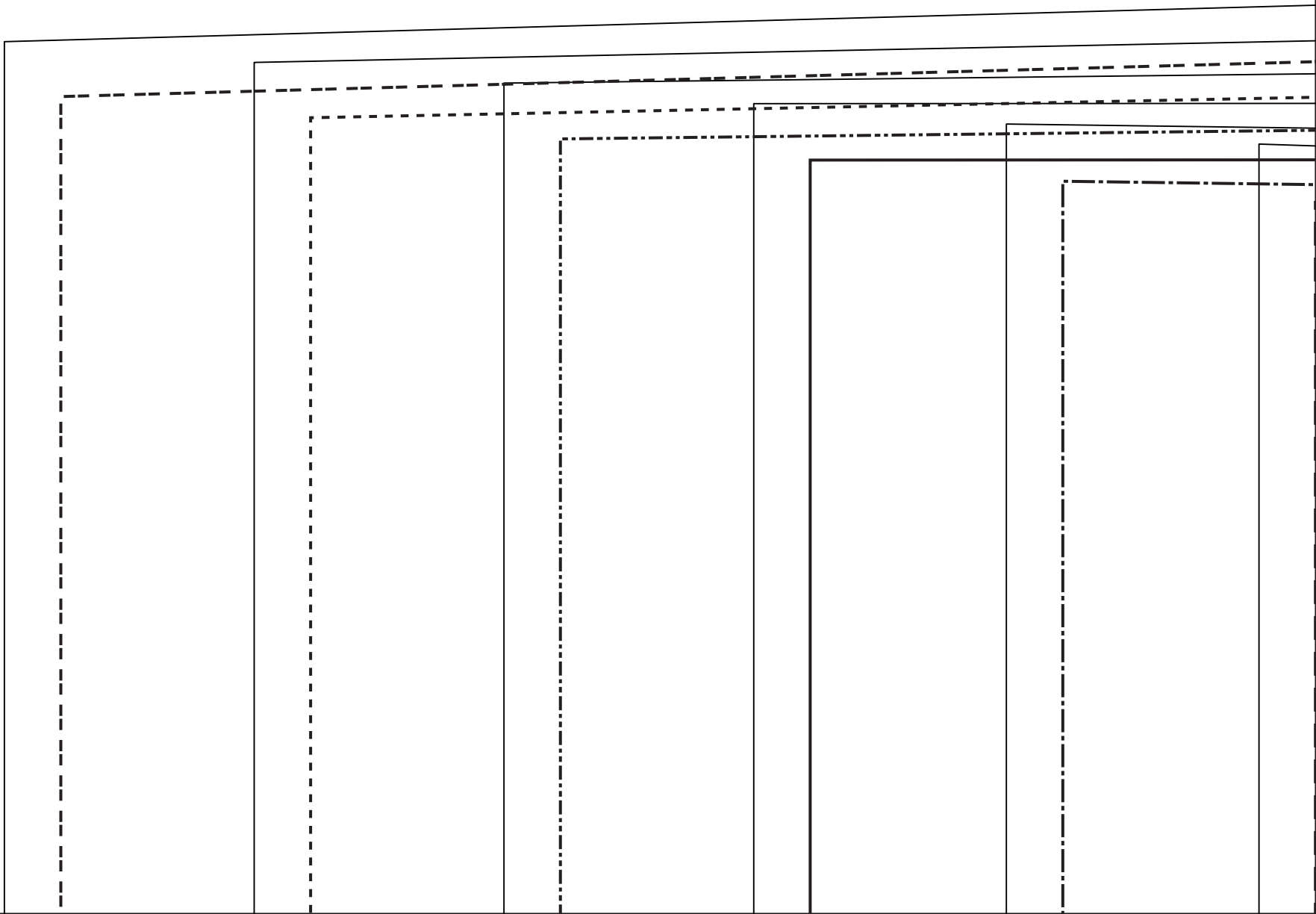

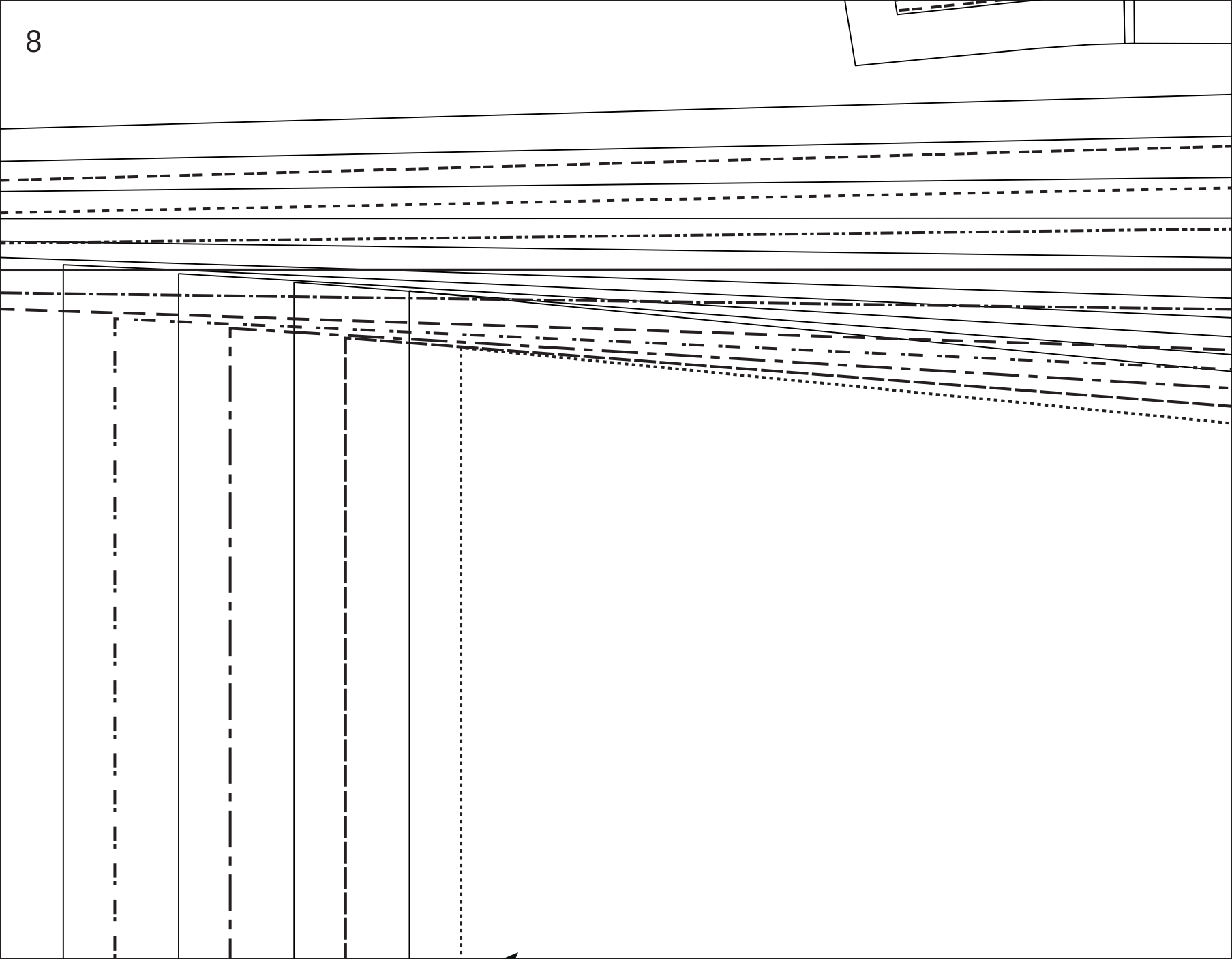

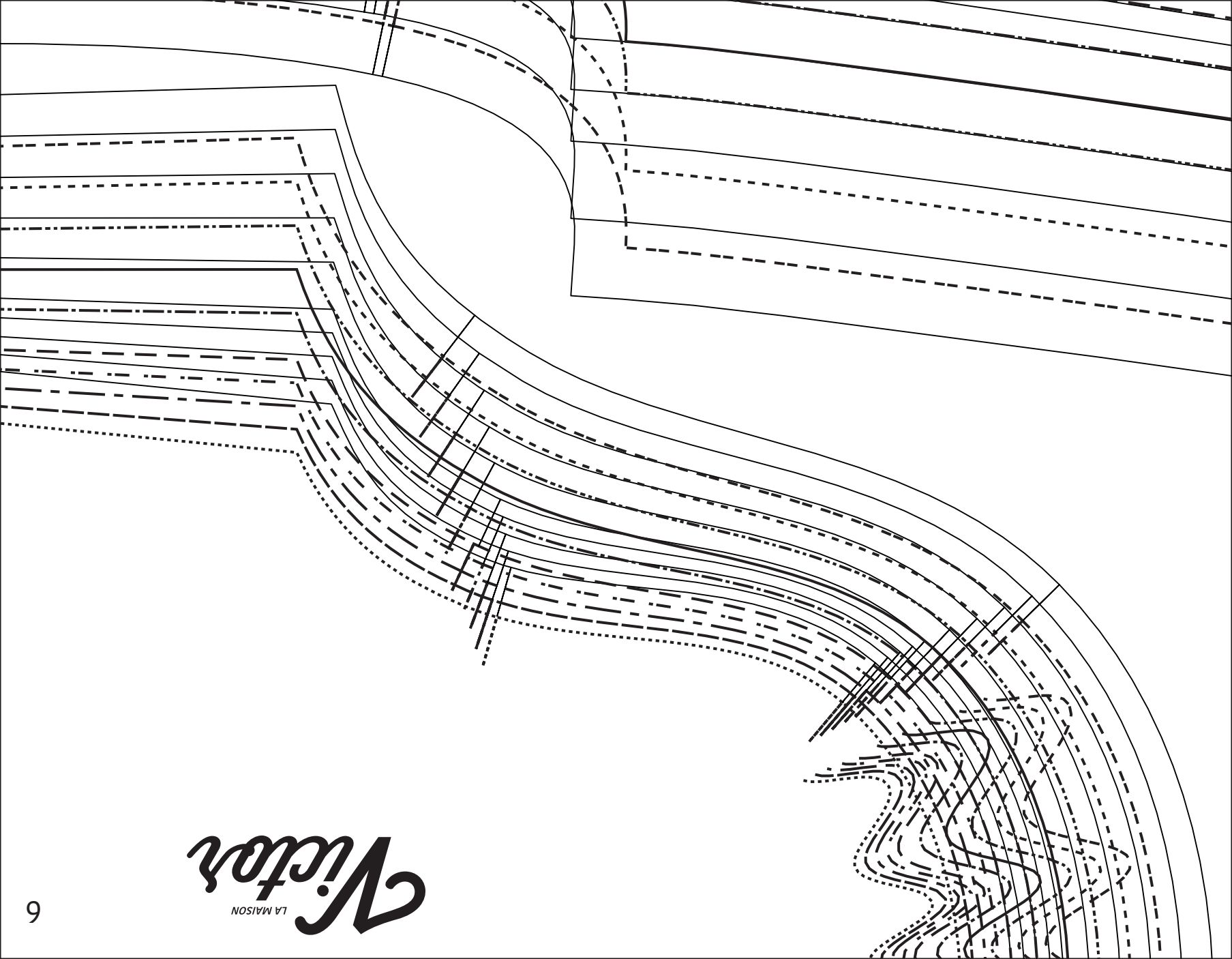

Victor
LA MAISON

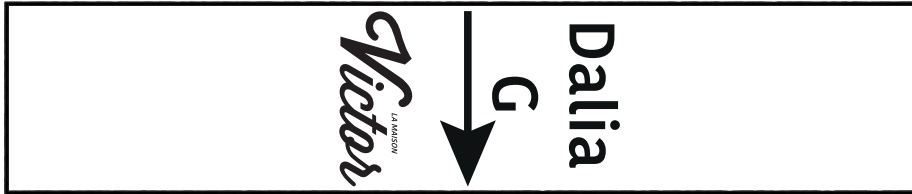

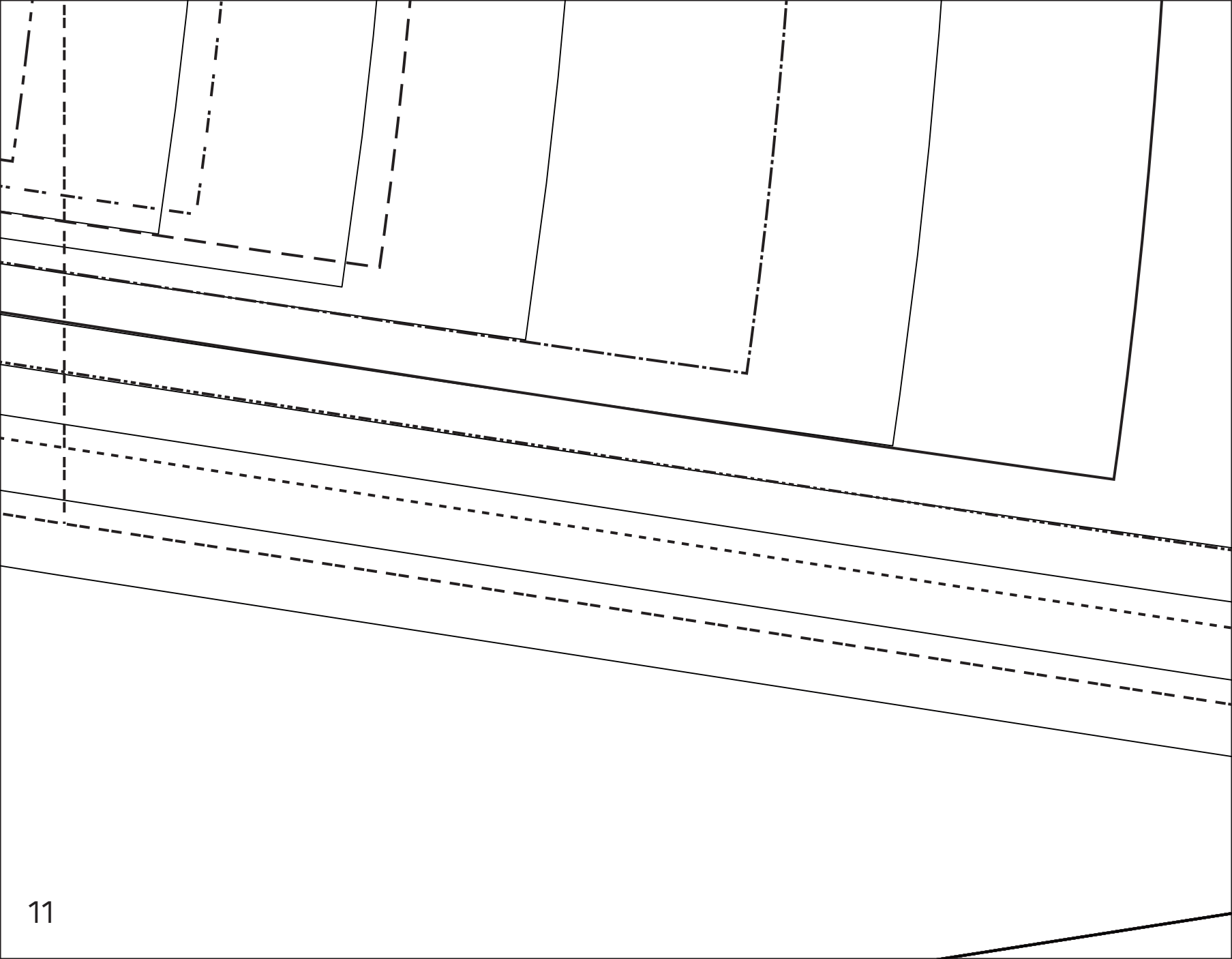

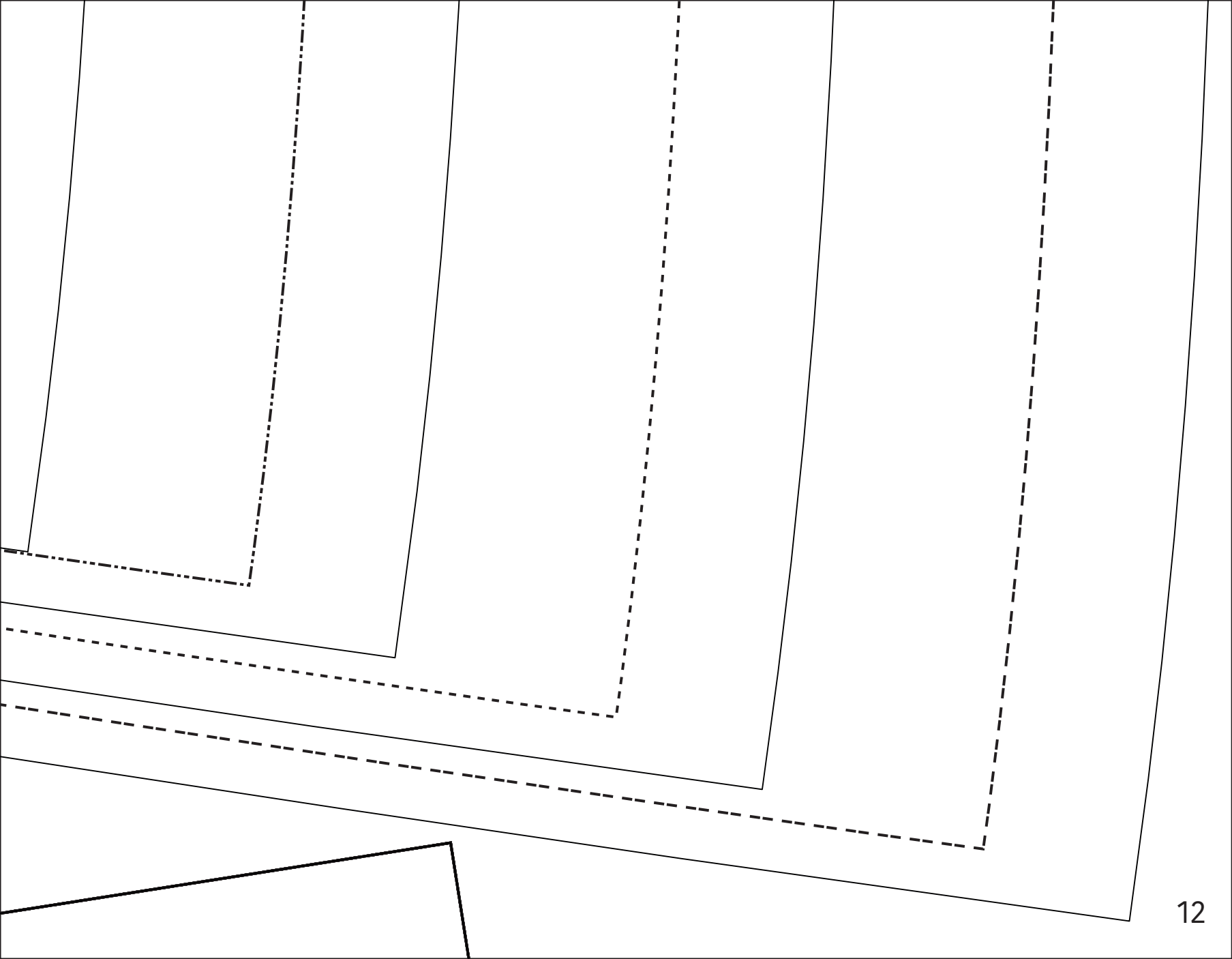

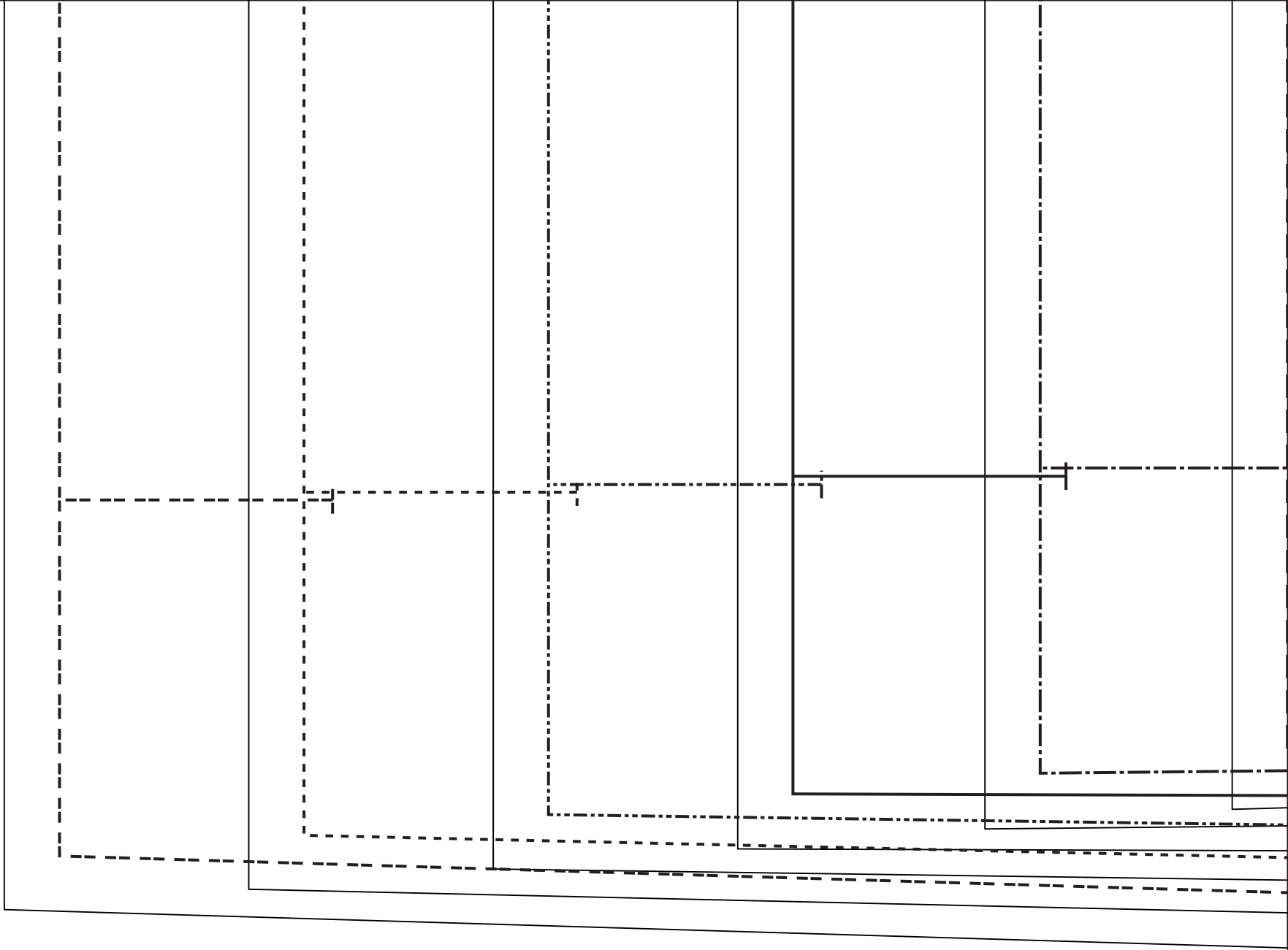

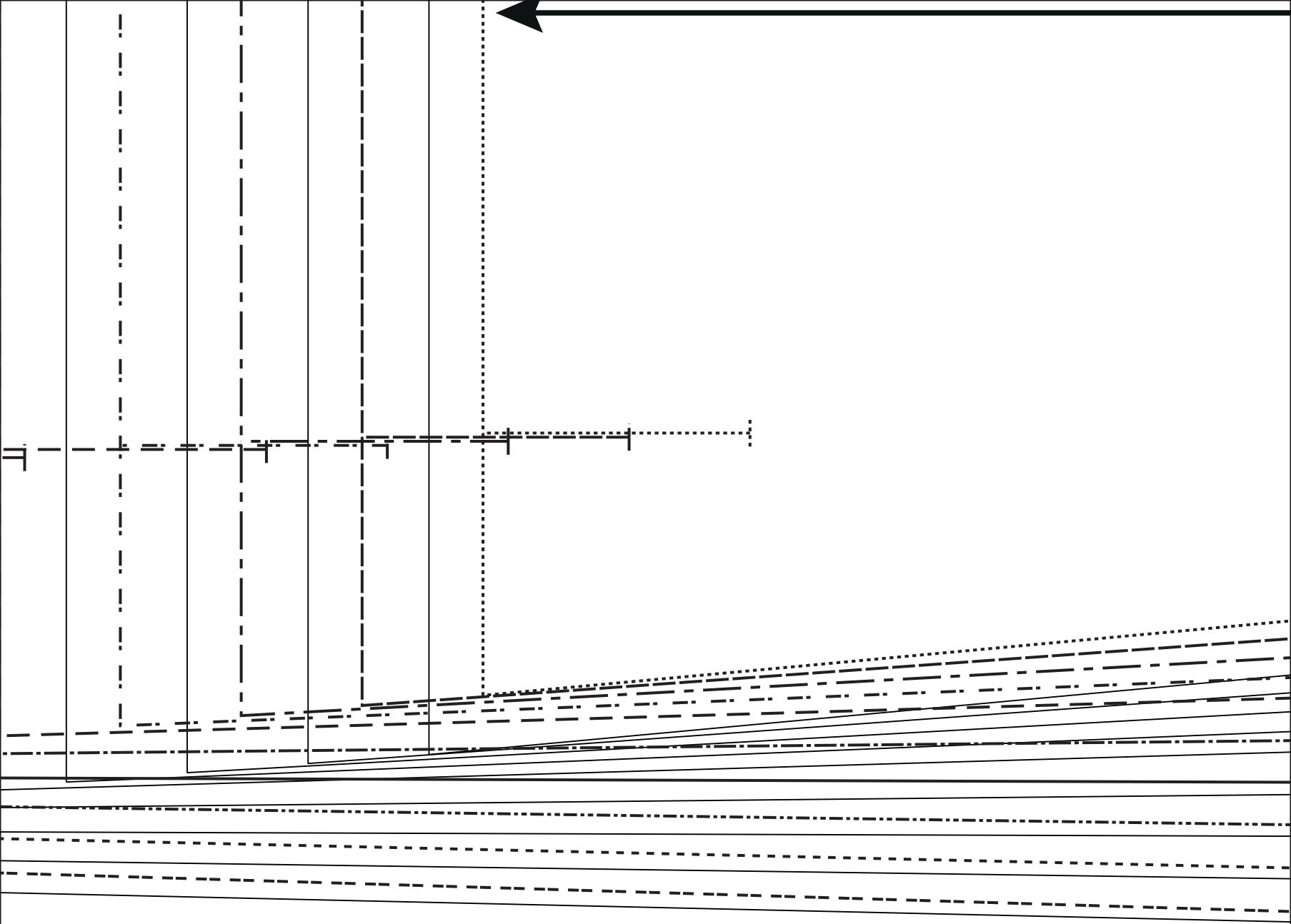

Dalia - F

15

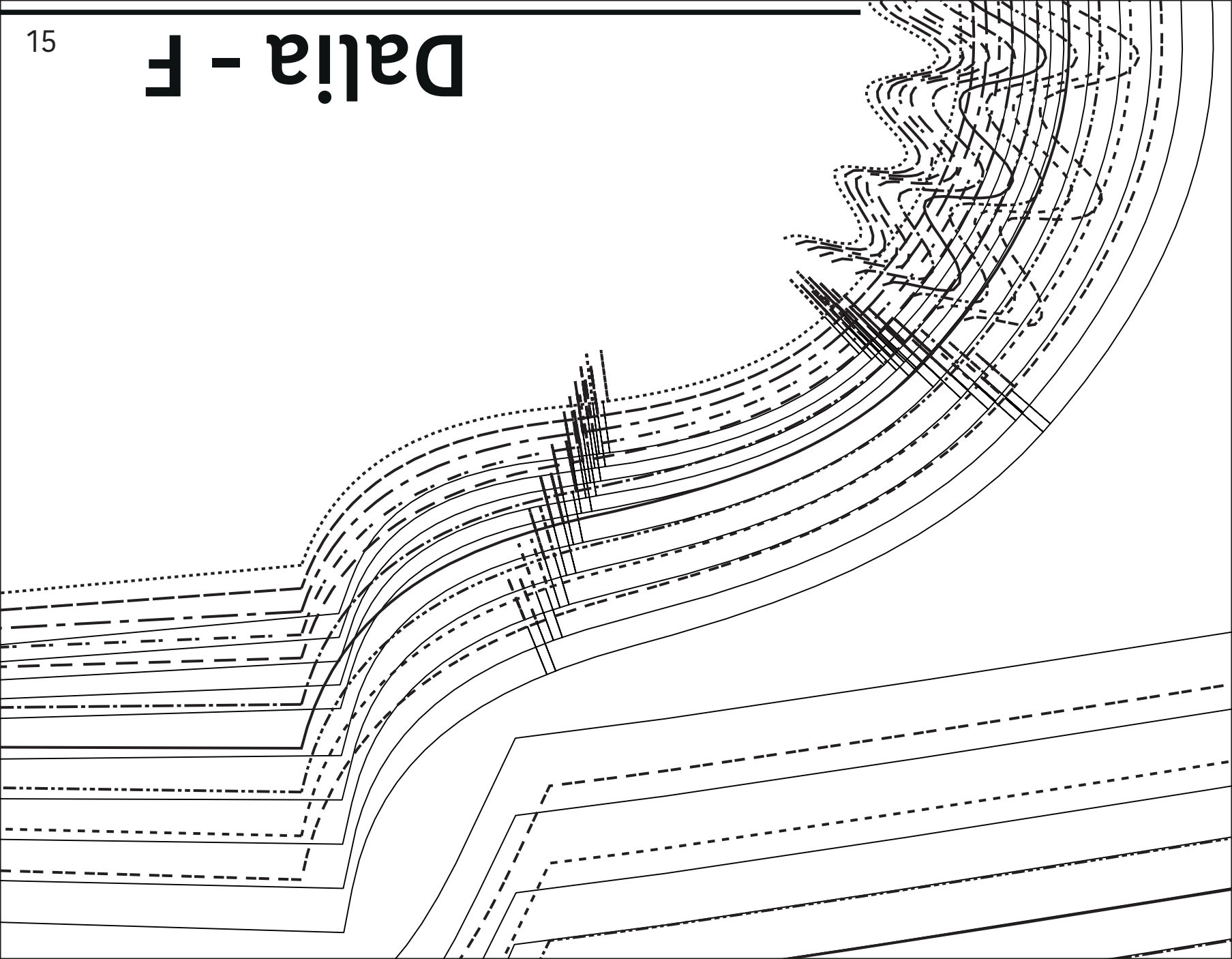

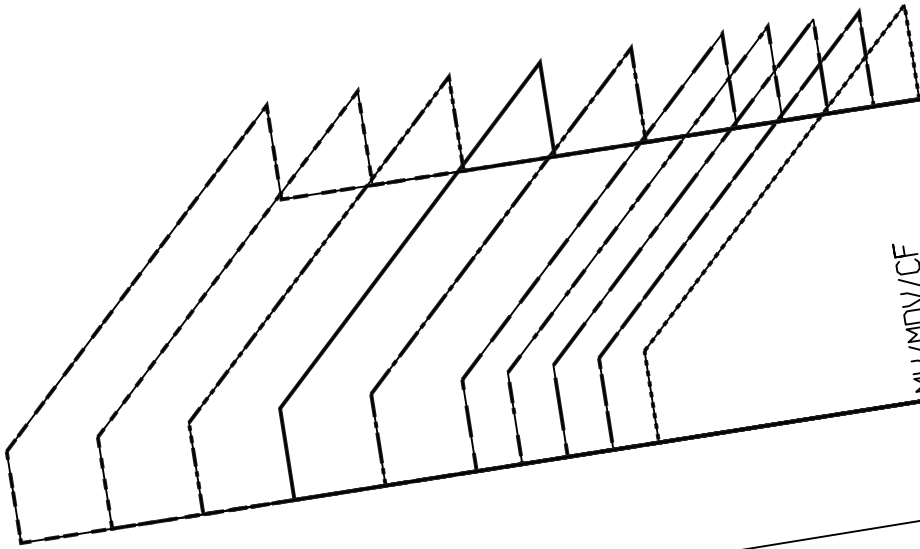

MV/MDV/CF
MV/MDV/CF
MV/MDV/CF
MV/MDV/CF
MV/MDV/CF
MV/MDV/CF
MV/MDV/CF
MV/MDV/CF
MV/MDV/CF
MV/MDV/CF

SN/CE/SHS

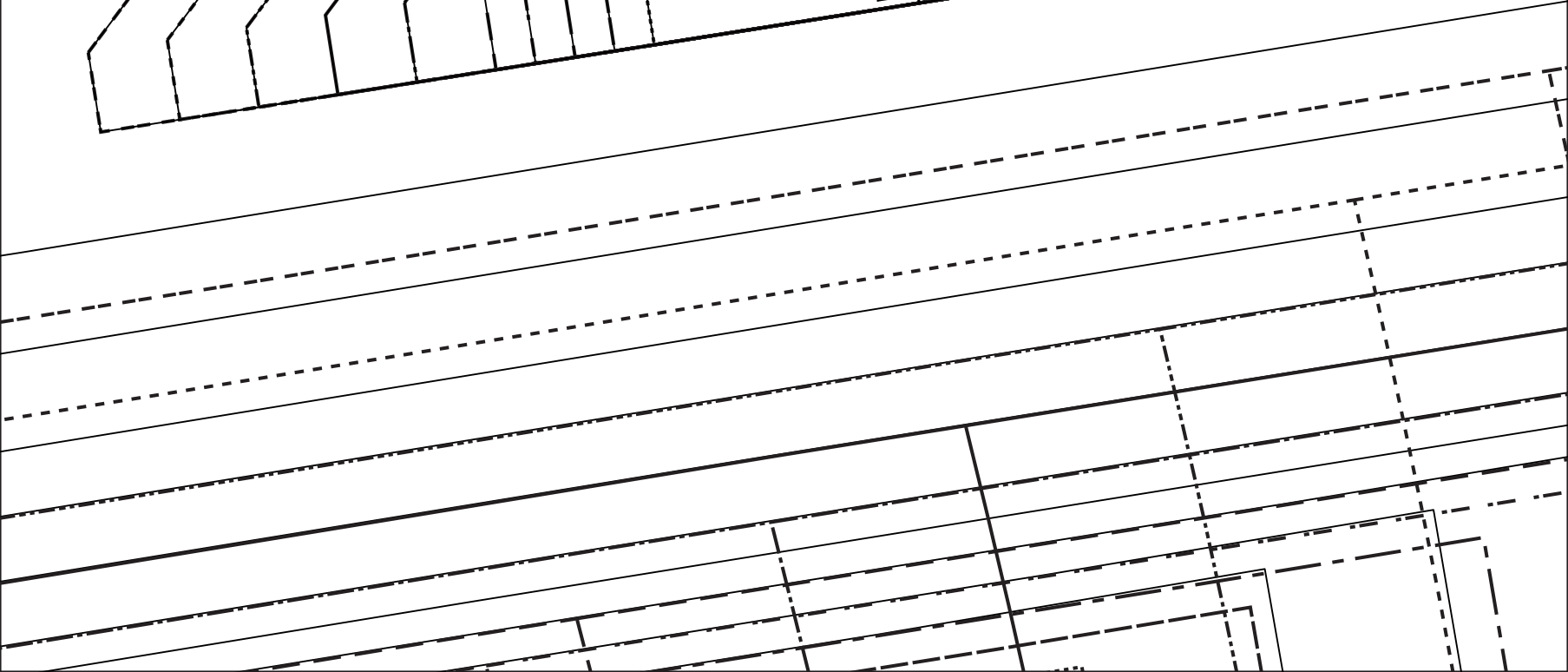

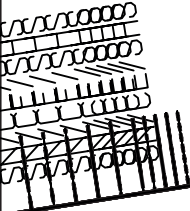

MR/MDS/CB

Dalia - D
Victor

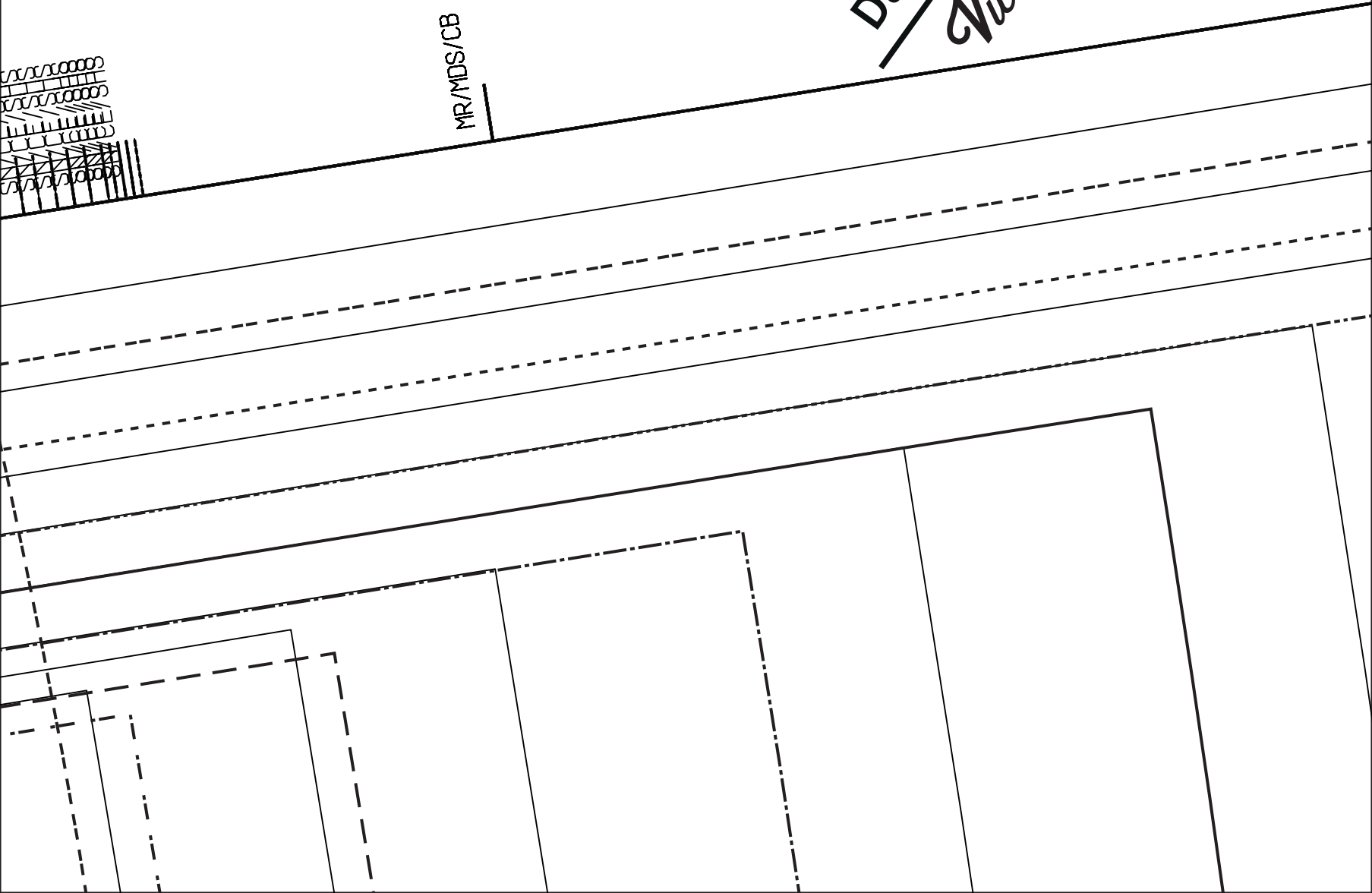

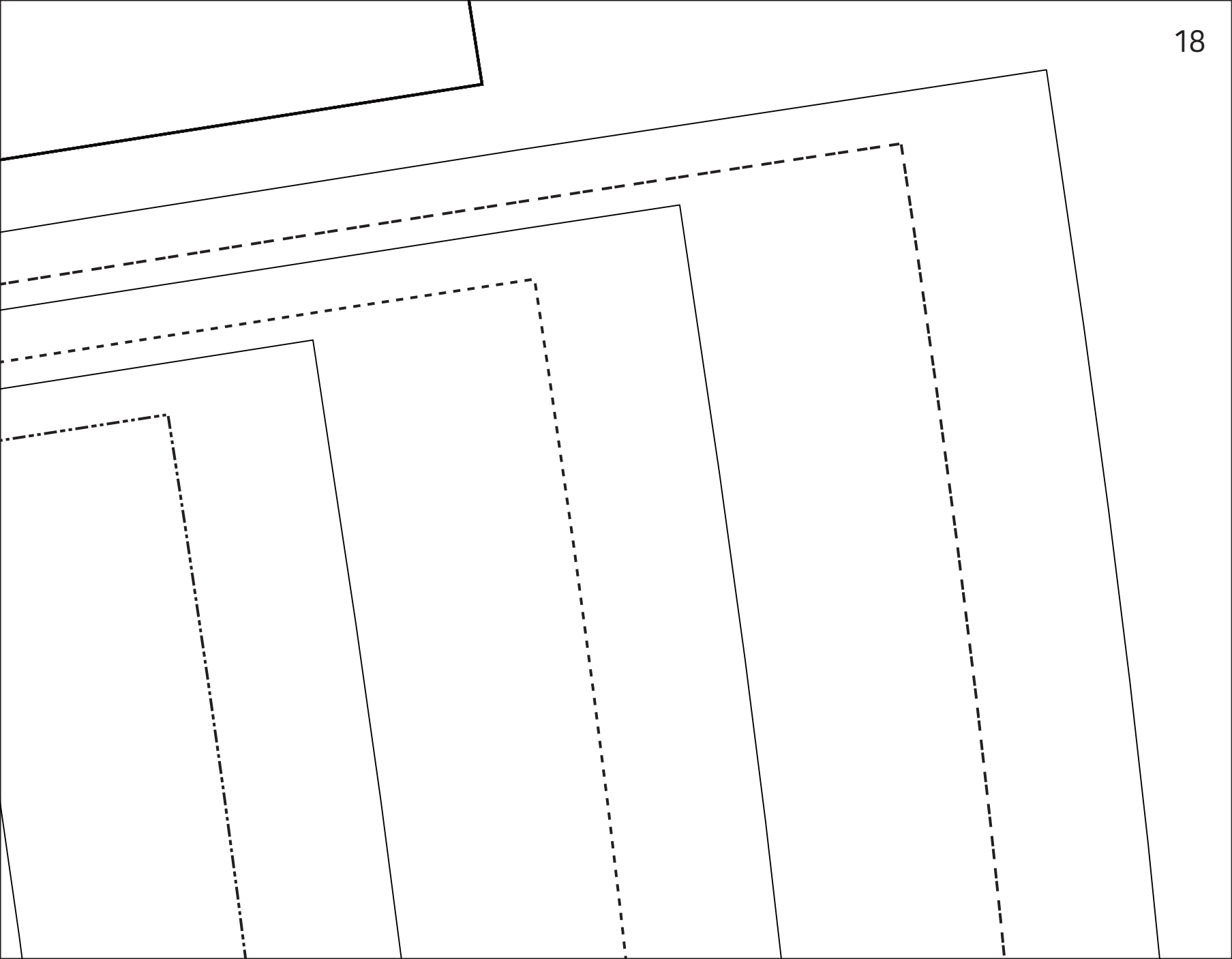

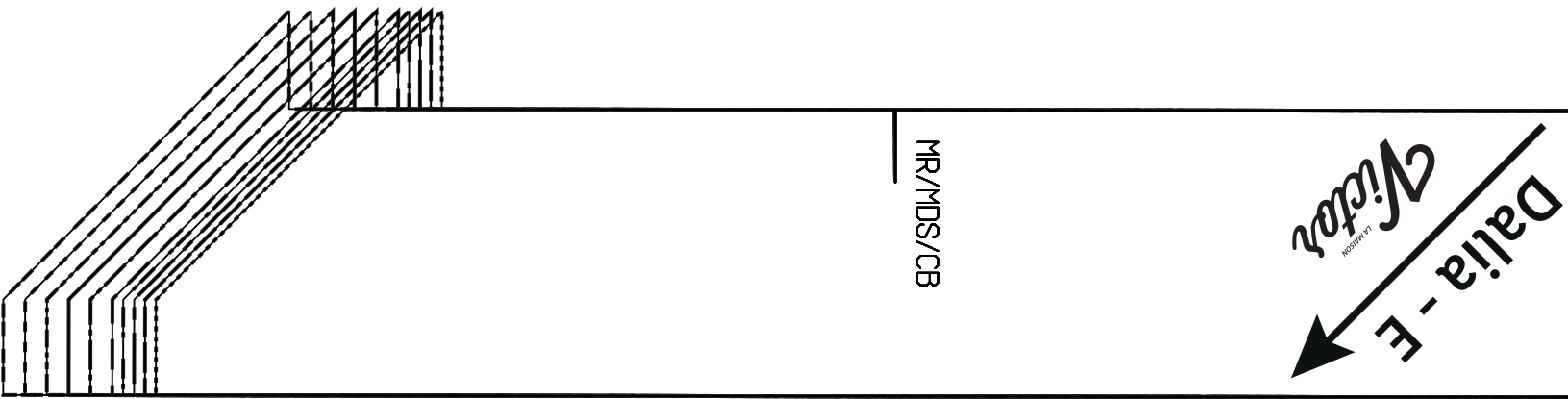
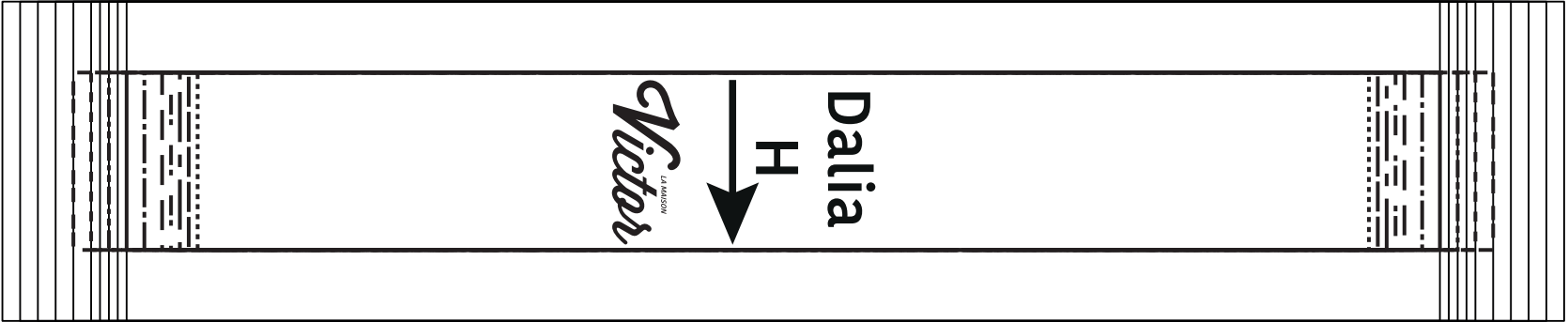

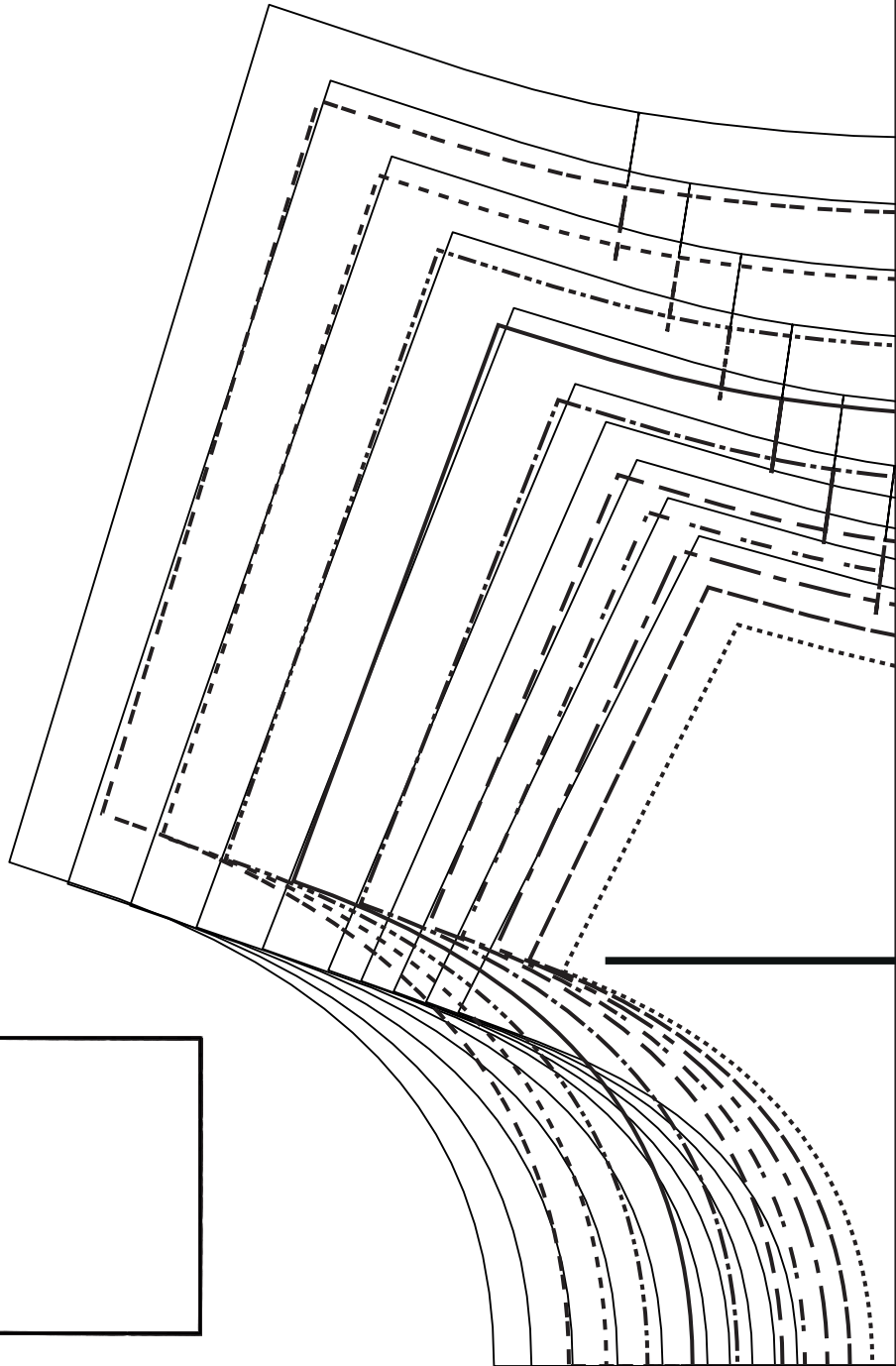

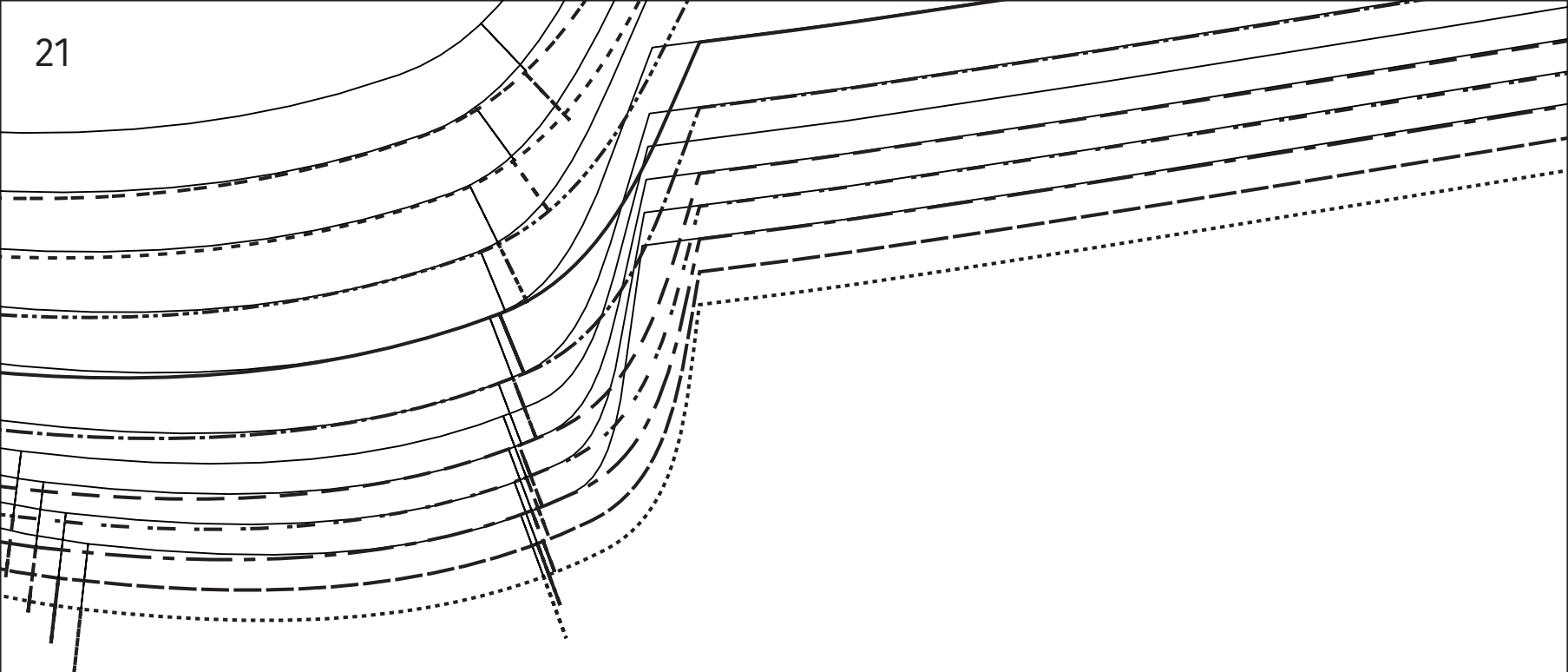

Dalia - A

LA MAISON
Victor

MV/MDV/CF



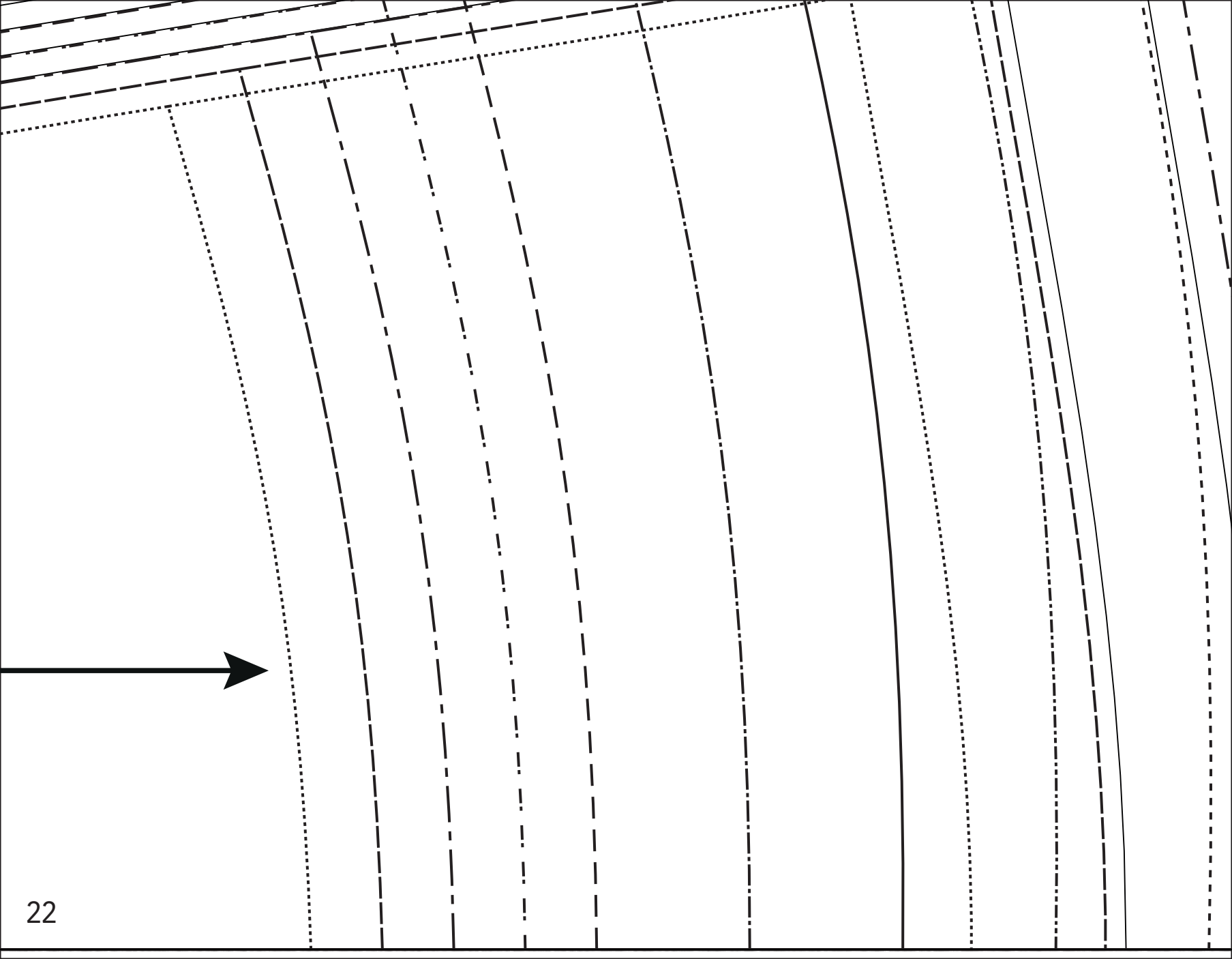

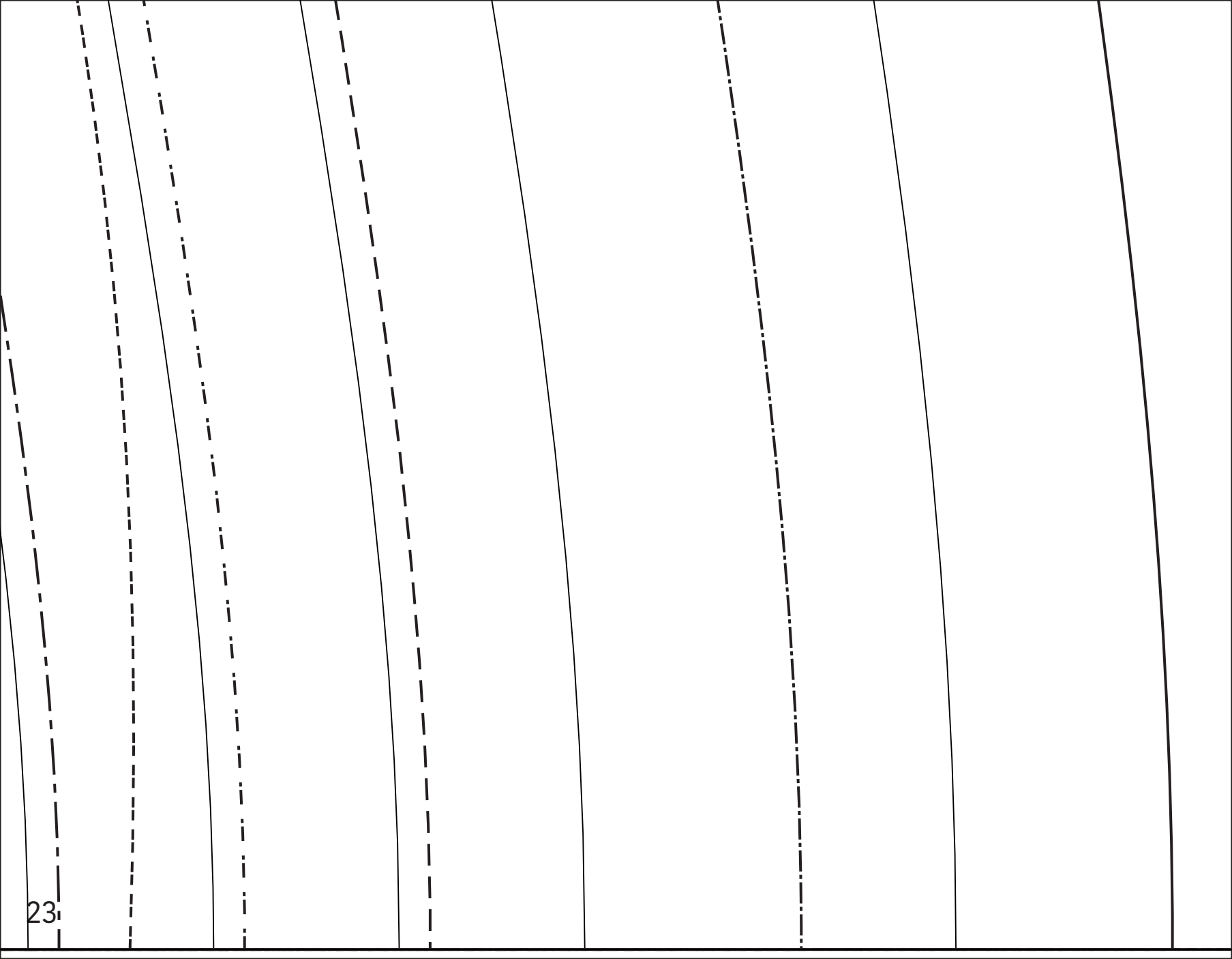

Dalia - C



Victor
LA MAISON



MV/MDV/CF

