

Carline

Jurk / Robe / Dress

Maten / Tailles / Sizes:

---	34
- - -	36
---	38
- . - . -	40
_____	42
-----	44
-----	46
- - -	48
- . - . -	50
---	52
-----	54
- . - . -	56

Patroondelen / Pièces du patron / Pattern pieces:

- A** voorpand / devant / front panel
- B** rugpand / dos / back panel
- C** taillestuk voorpand / empiècement
taille devant / waist insert FP
- D** taillestuk rugpand / empiècement
taille dos / waist insert BP
- E** beleg VP / parementure DV /
facing FP
- F** beleg RP / parementure DS /
facing BP

1	2	3	4	5	6
7	8	9	10	11	12
13	14	15	16	17	18
19	20	21	22	23	24
25	26	27	28	29	30
31	32	33	34	35	36
37					

Controlevierkant / Carré de controle / Test square / Kontrollquadrat

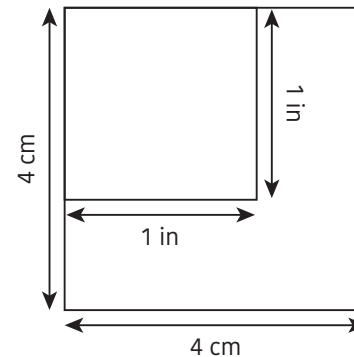

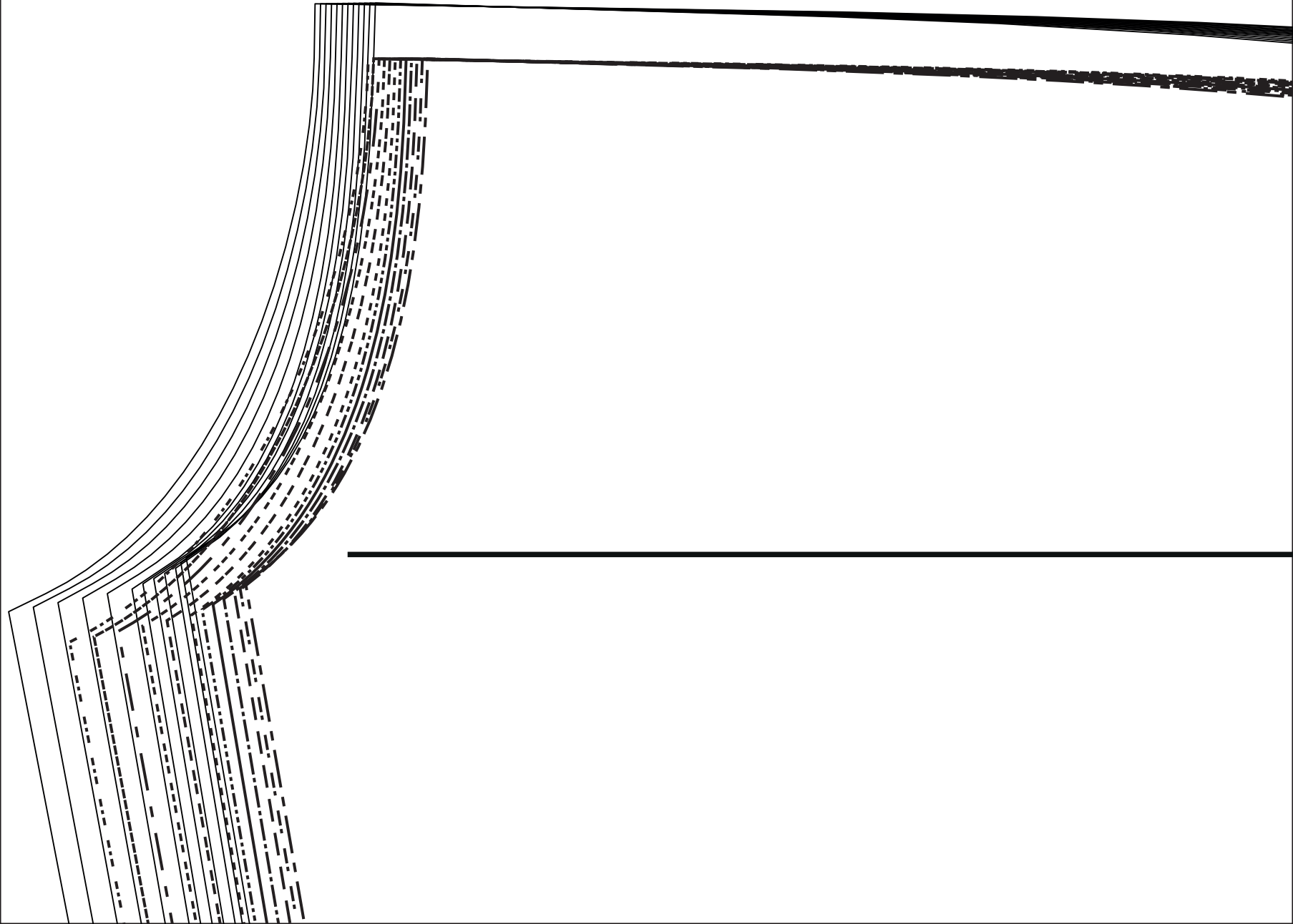

Carline - B

Victor LA MAISON

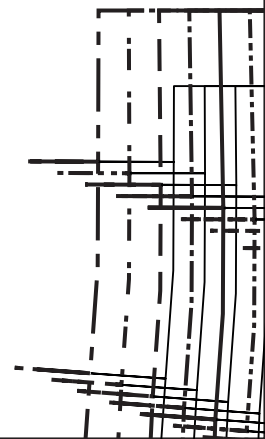

MR/MDS/CB

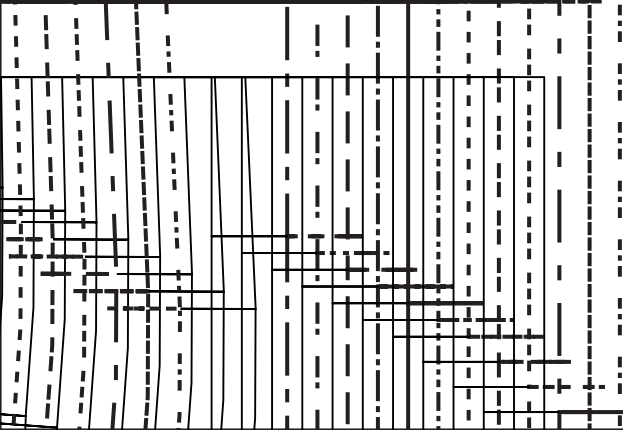

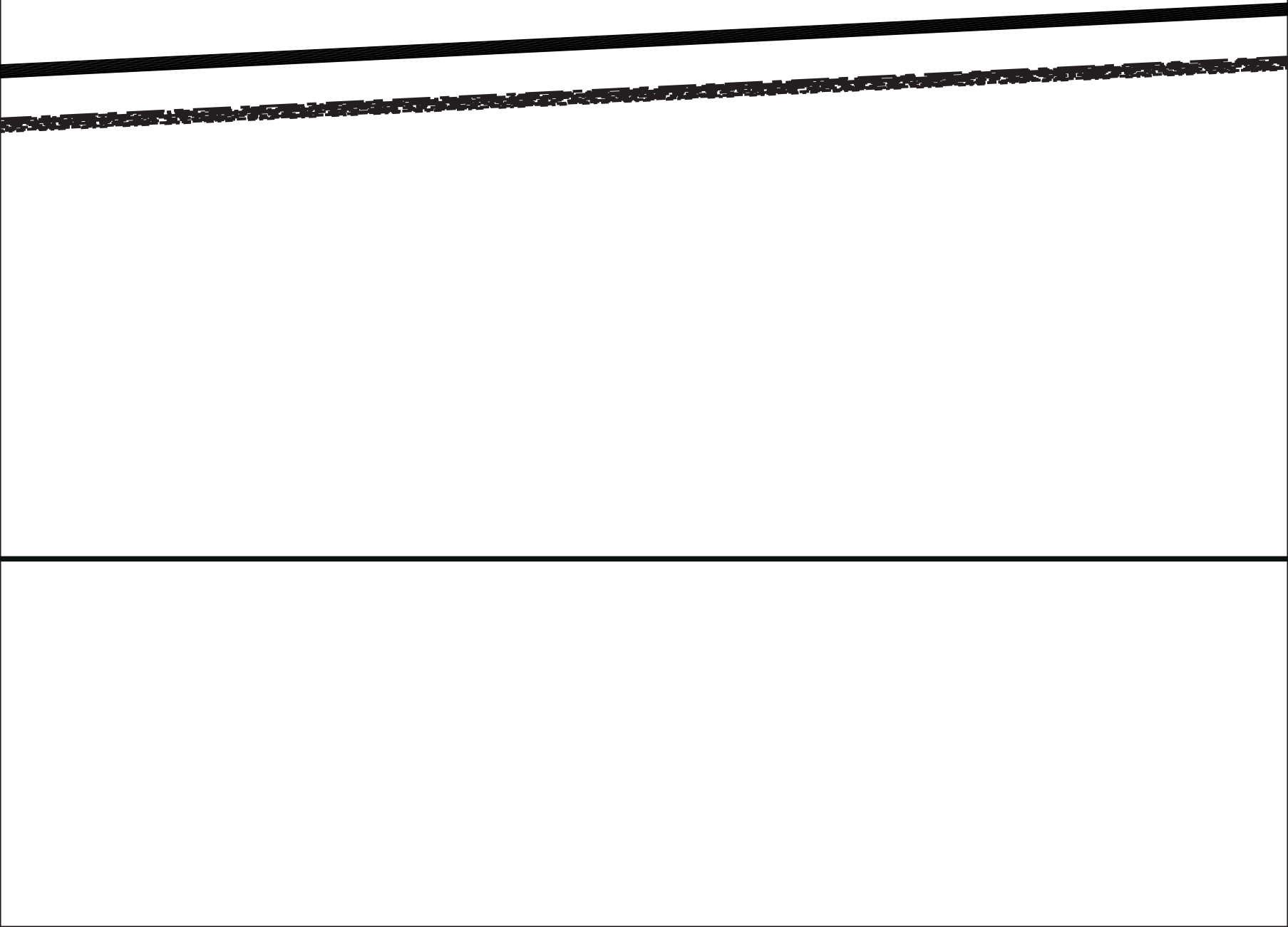

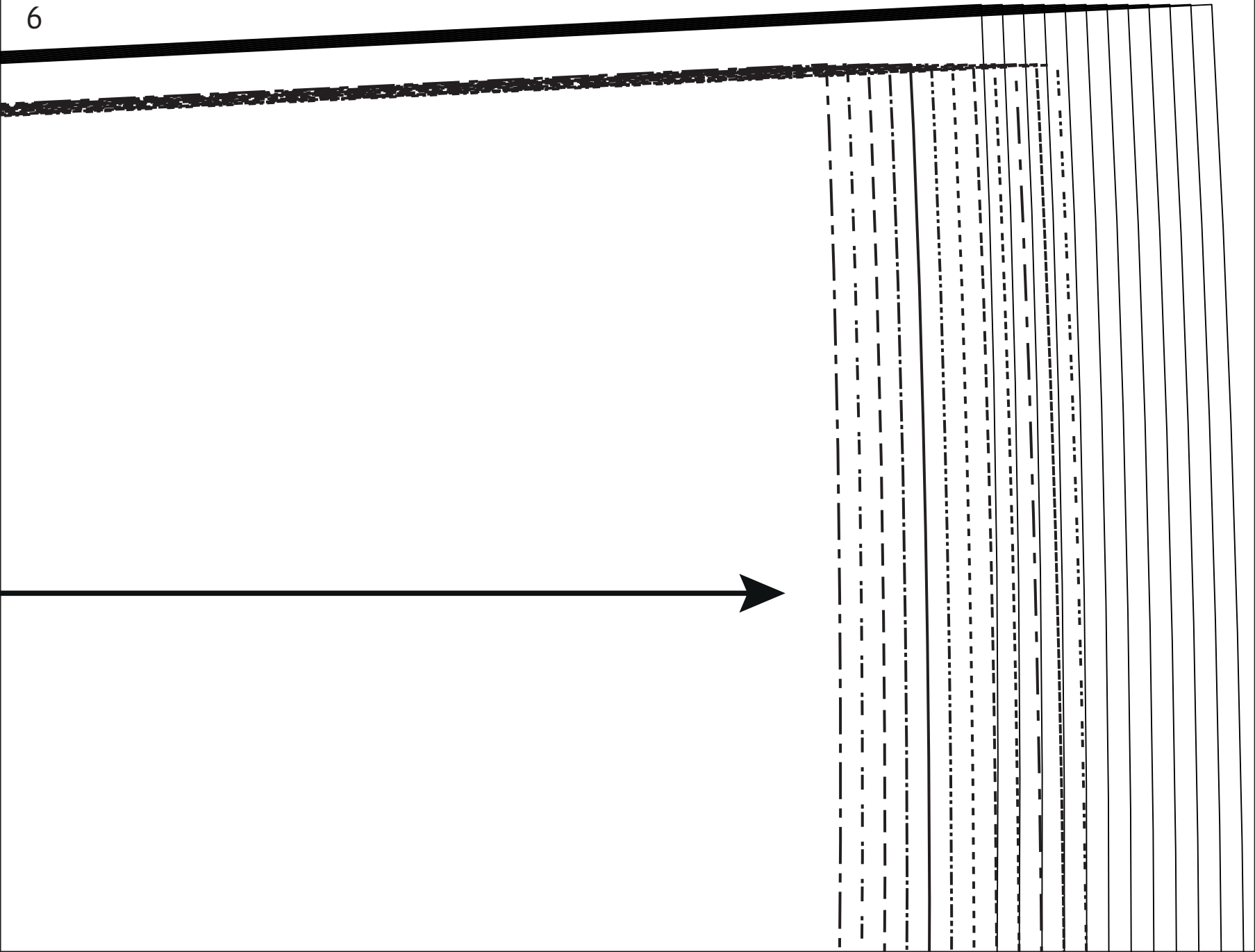

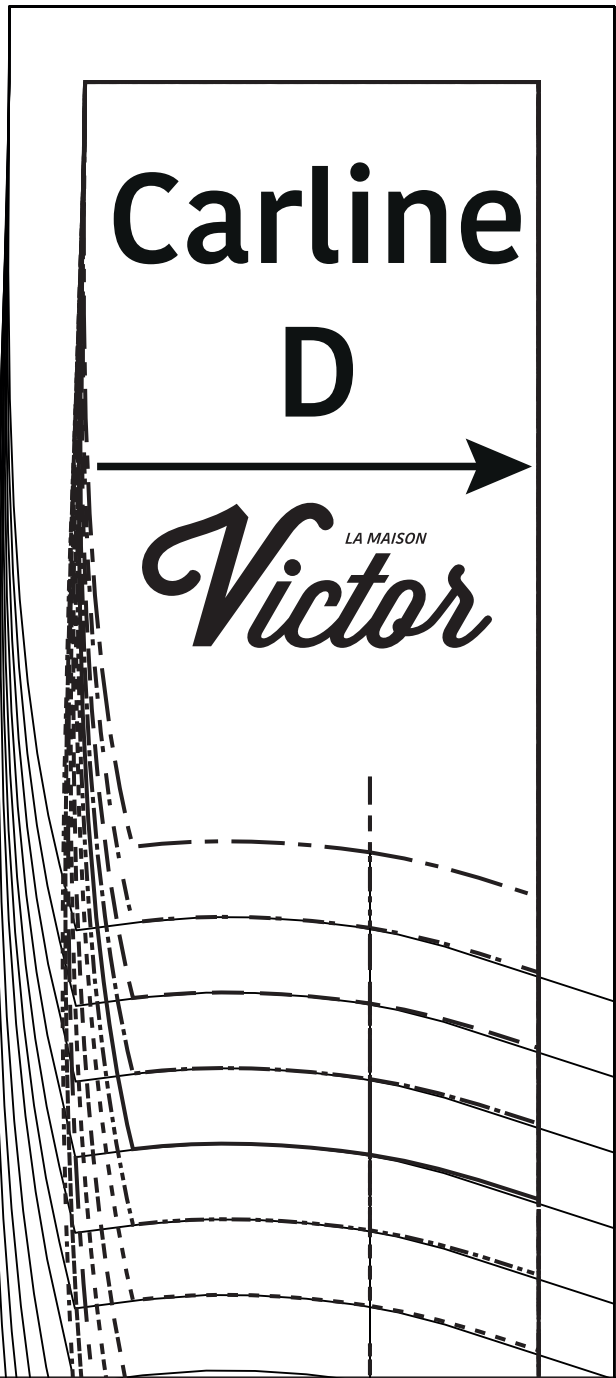
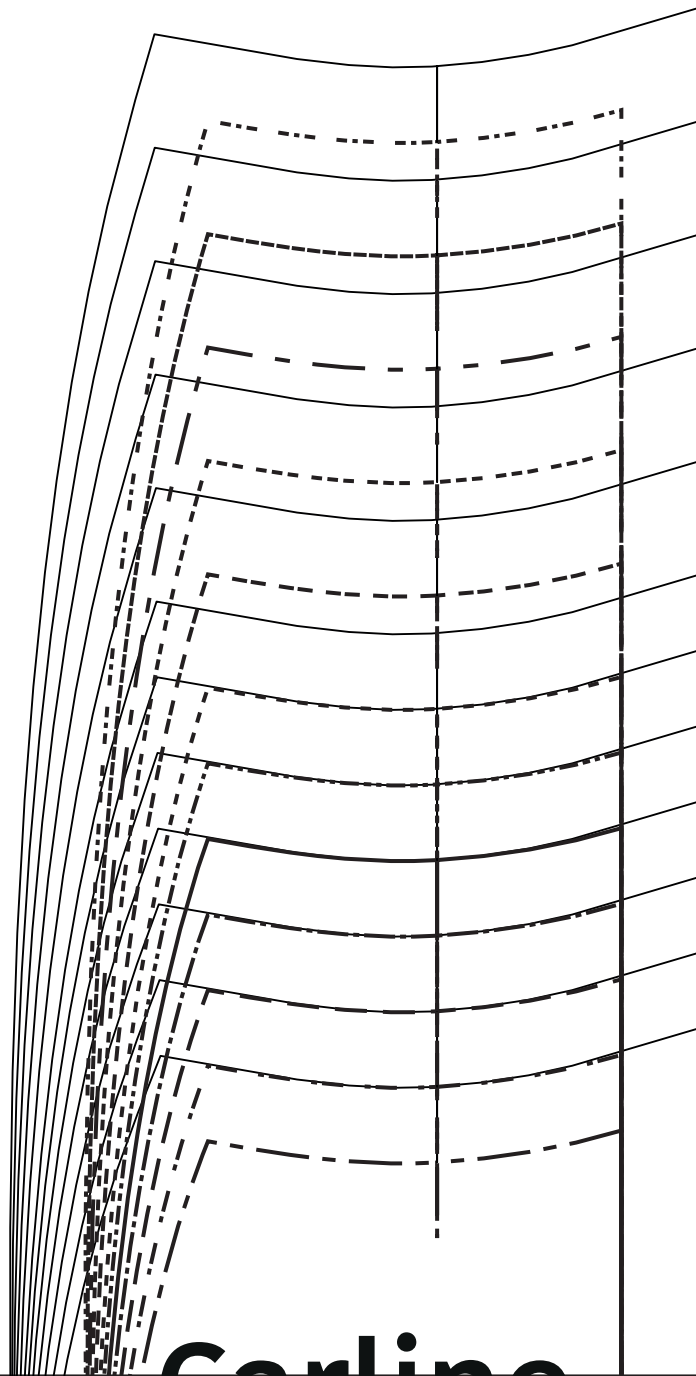

Carline

D



Victor
LA MAISON

Carline

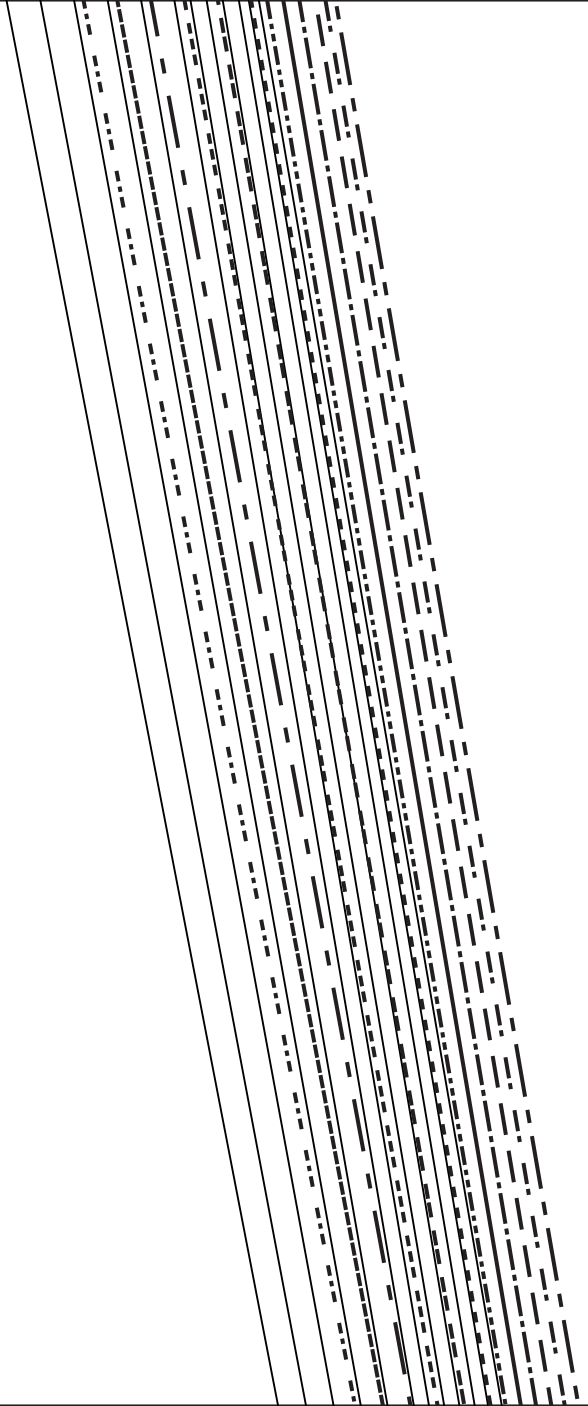

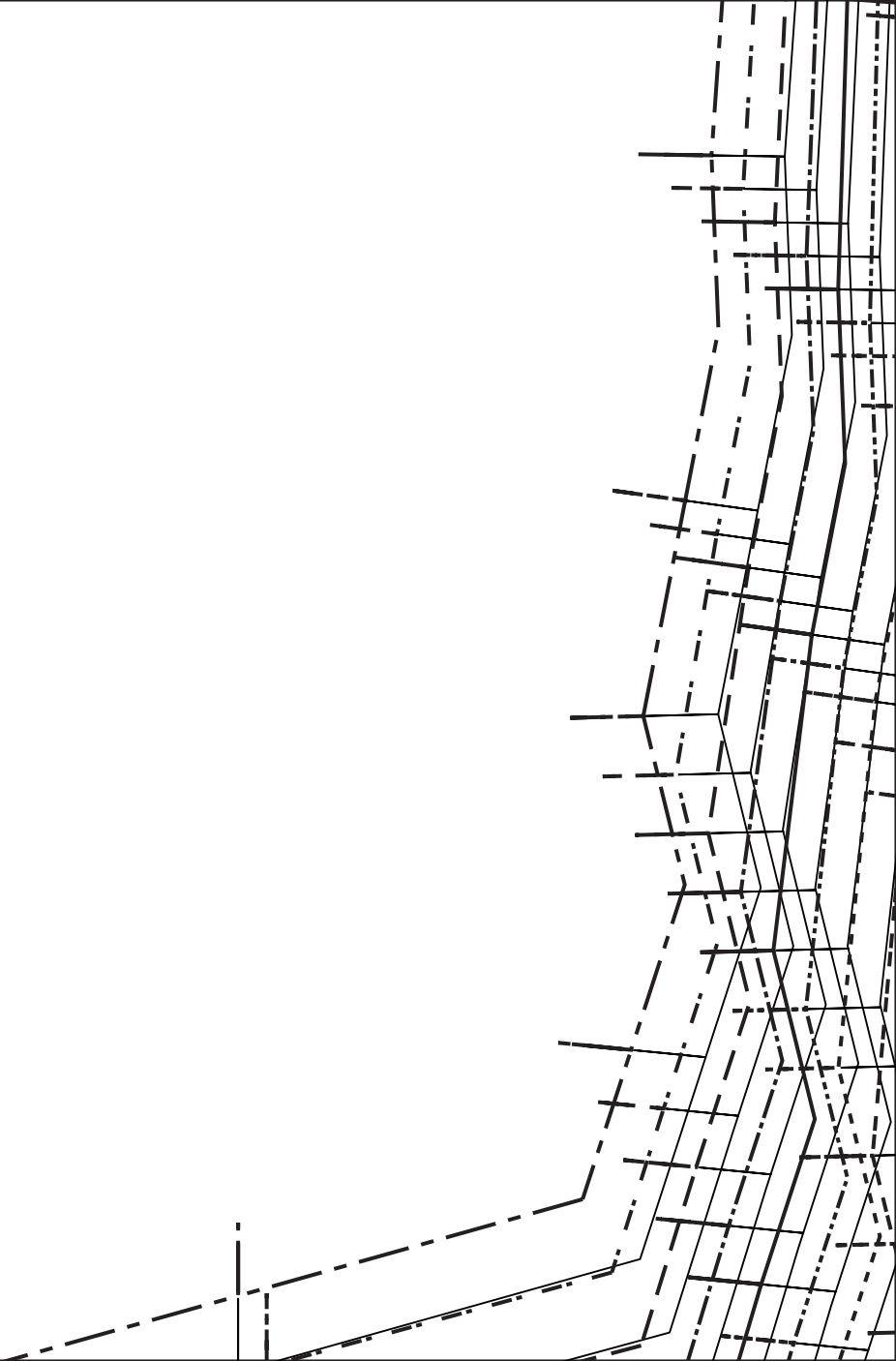

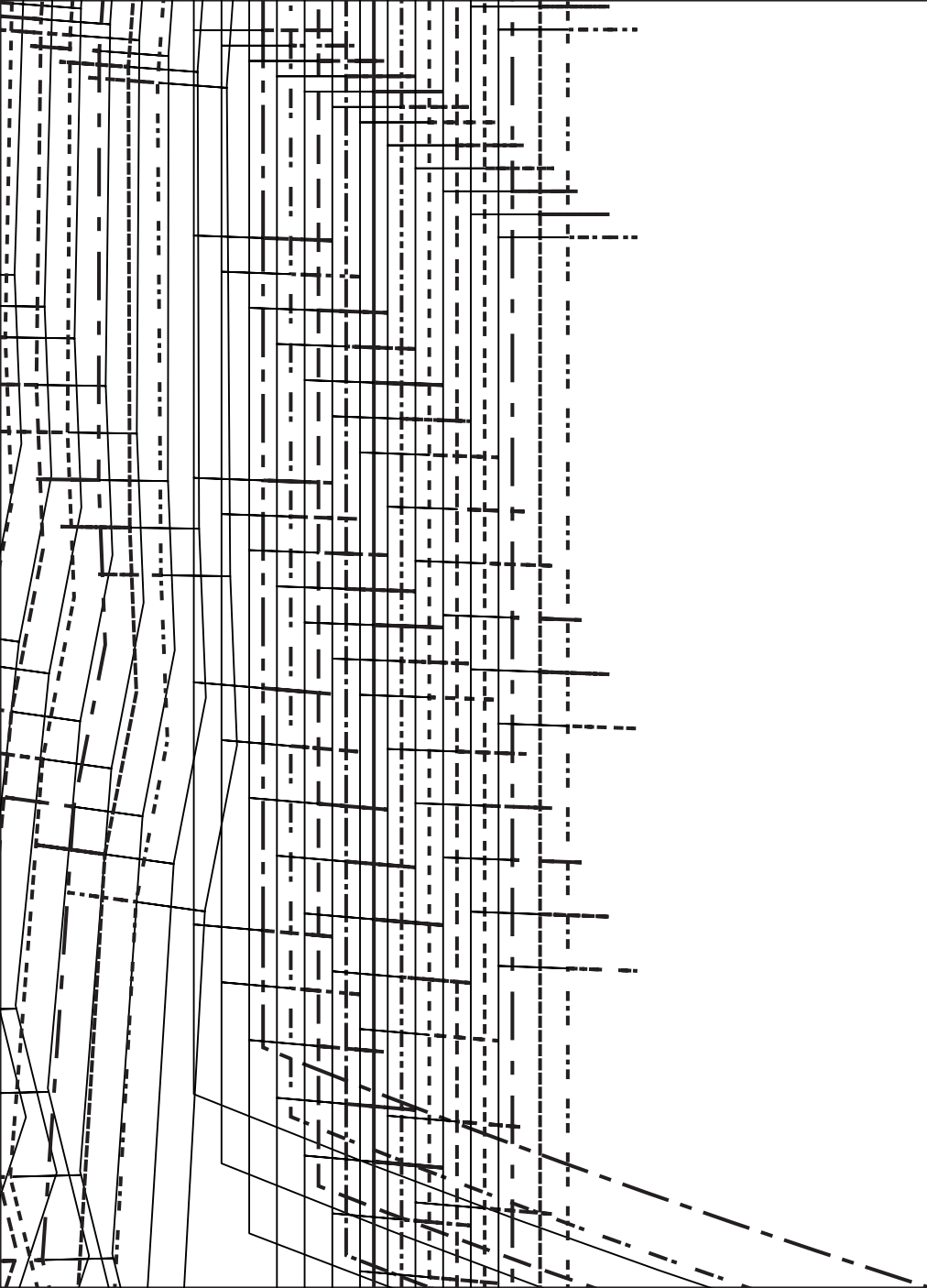

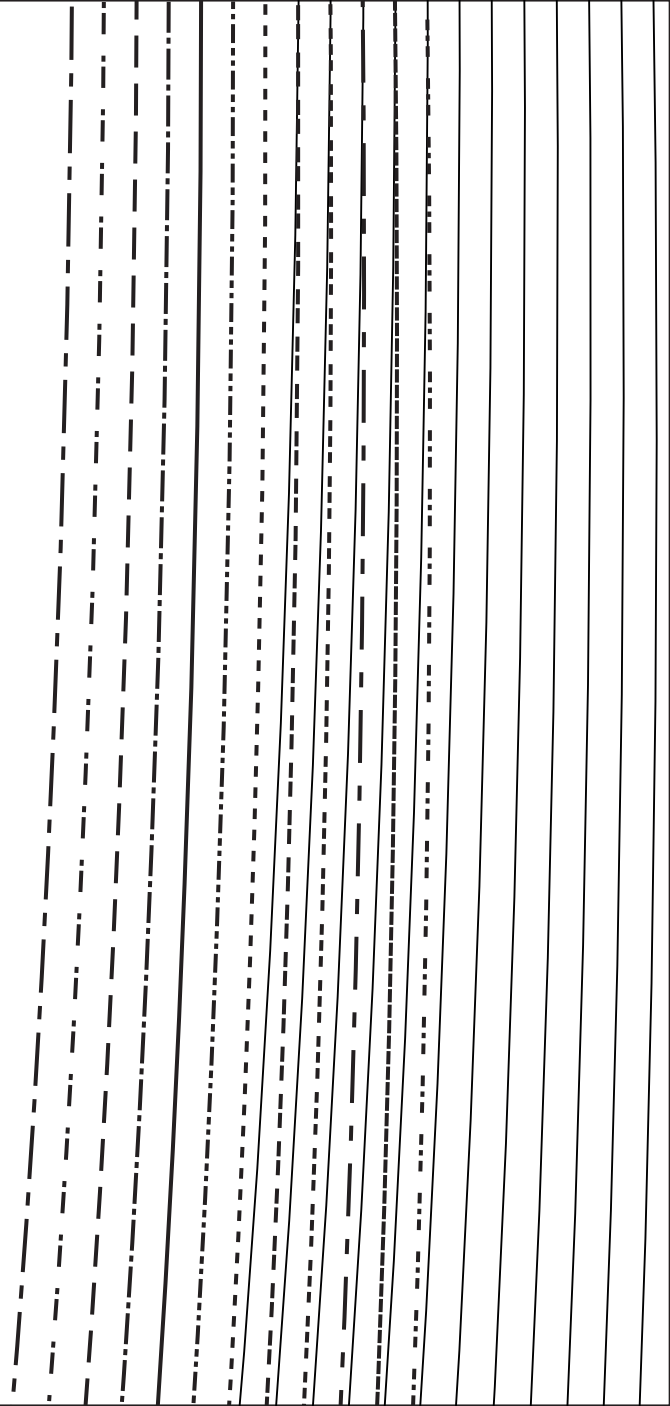

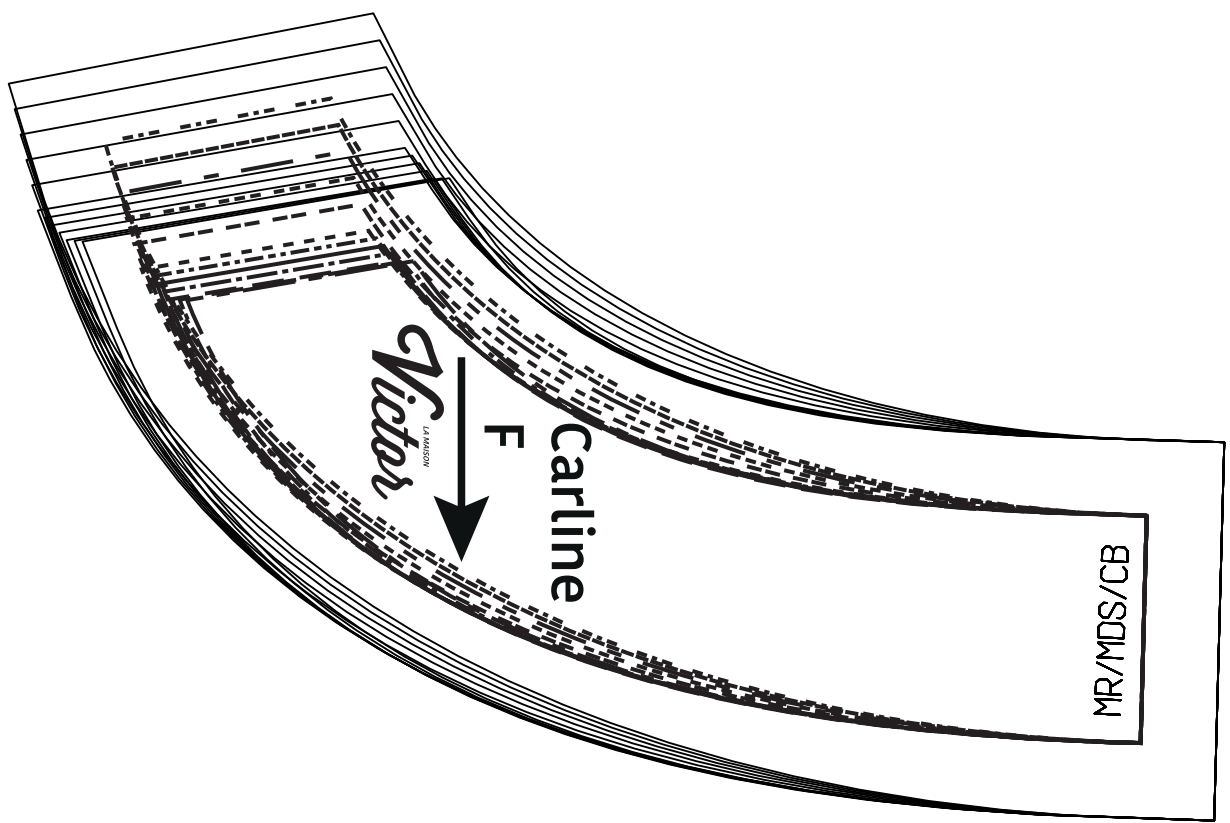
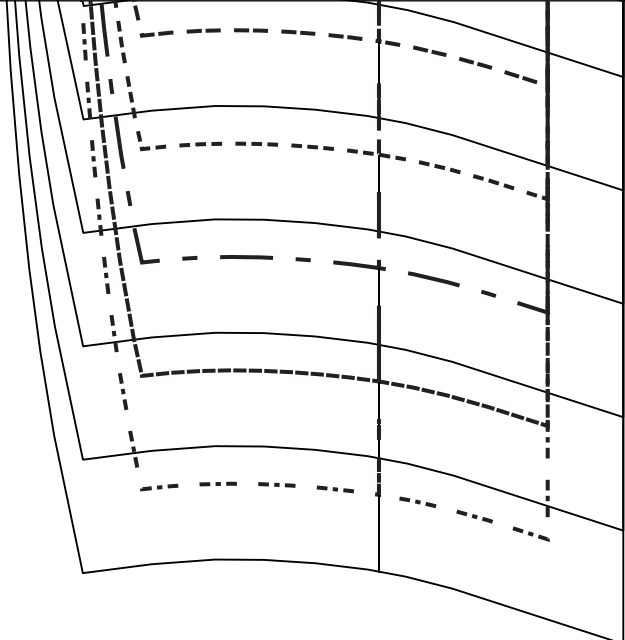
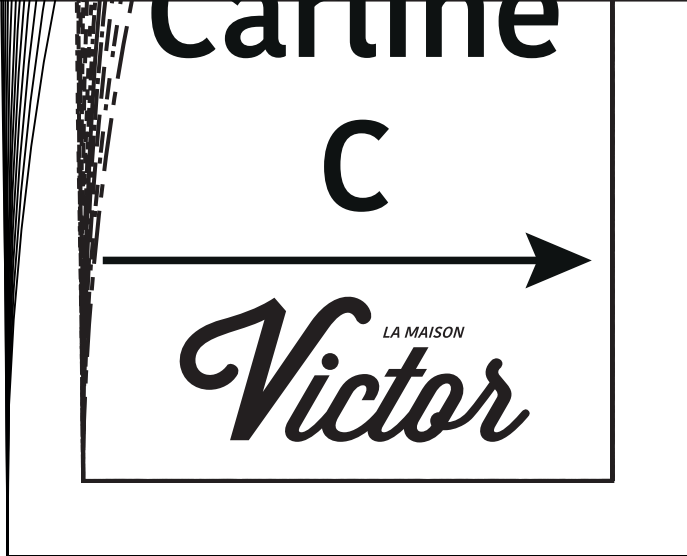

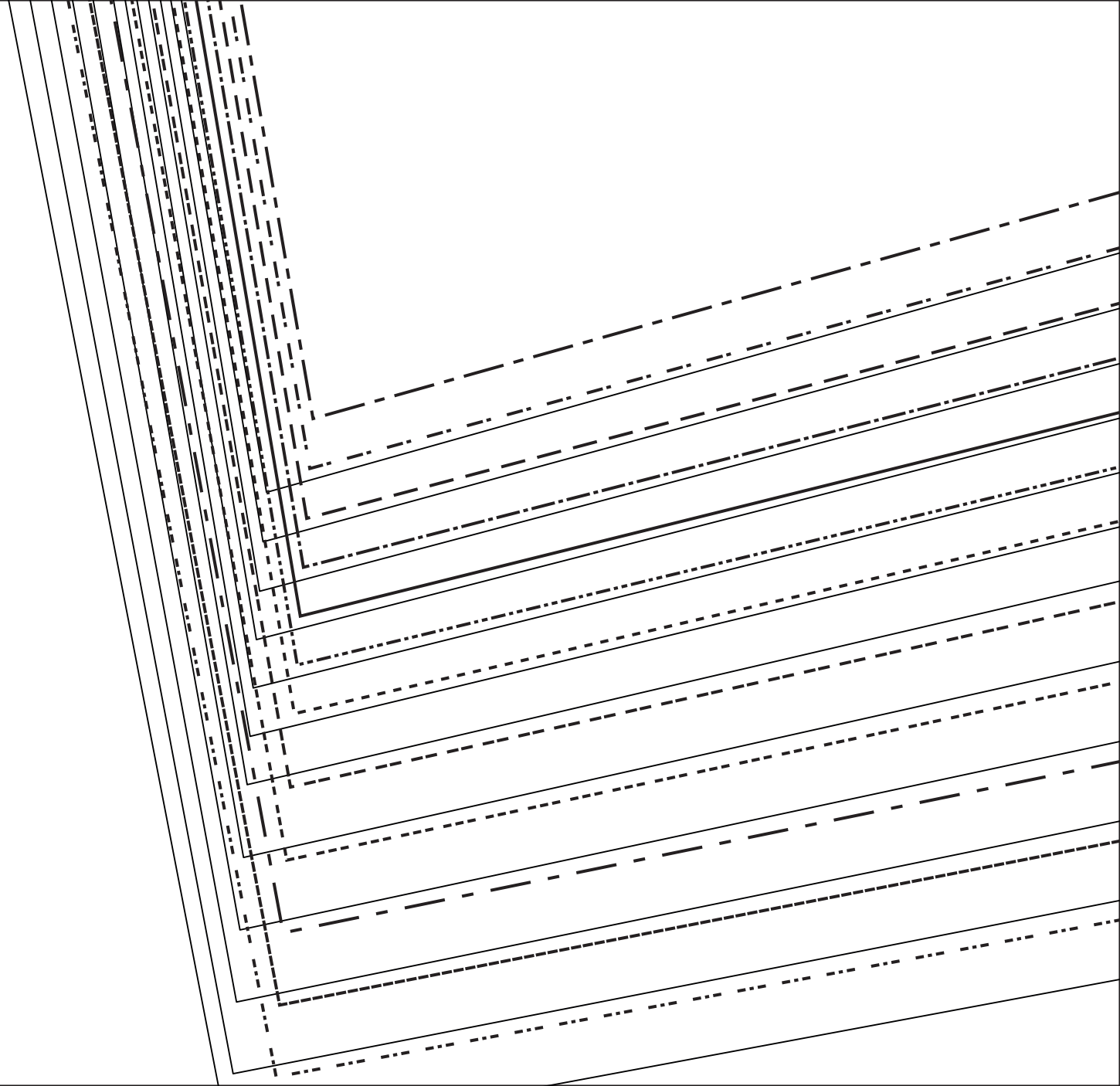

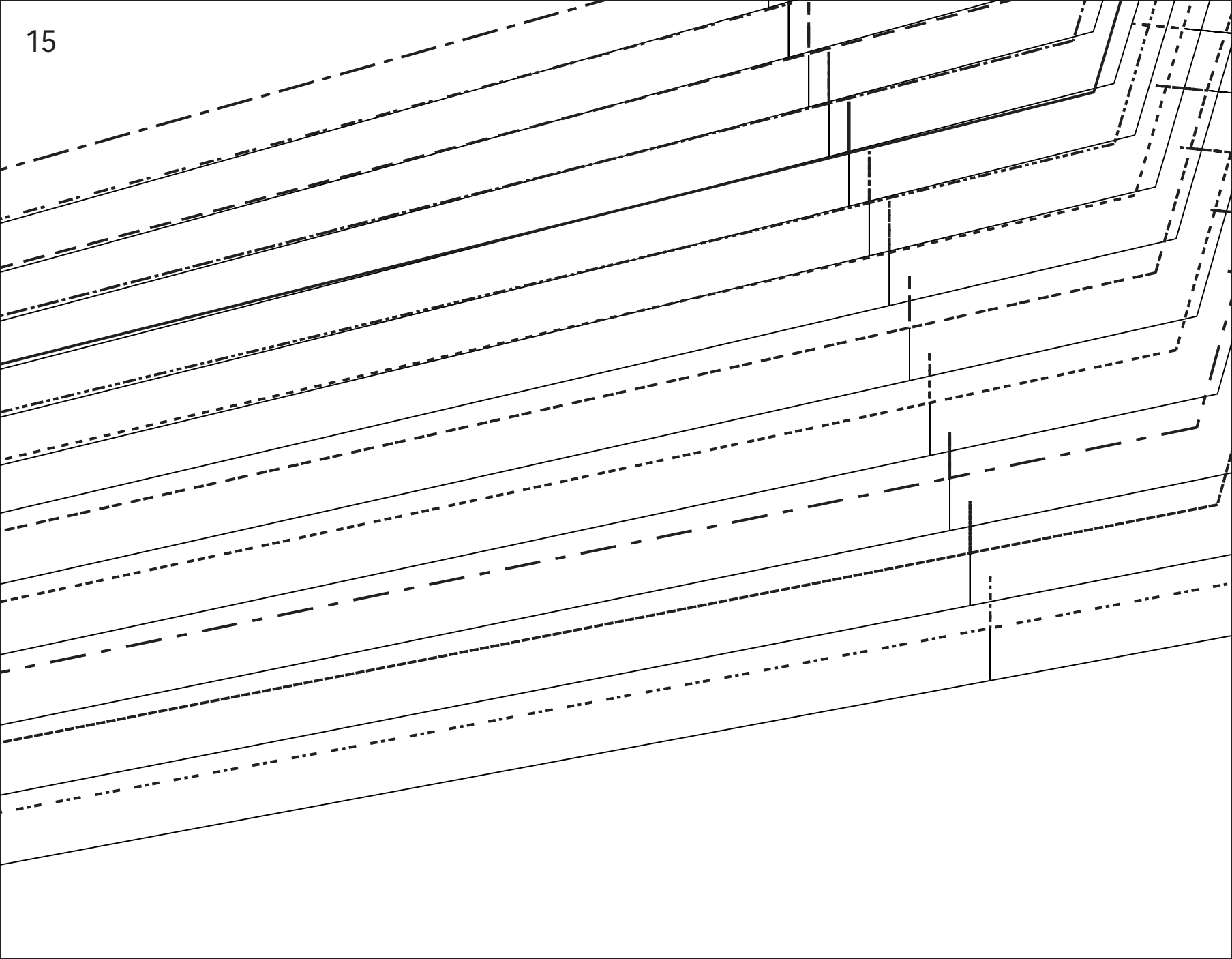

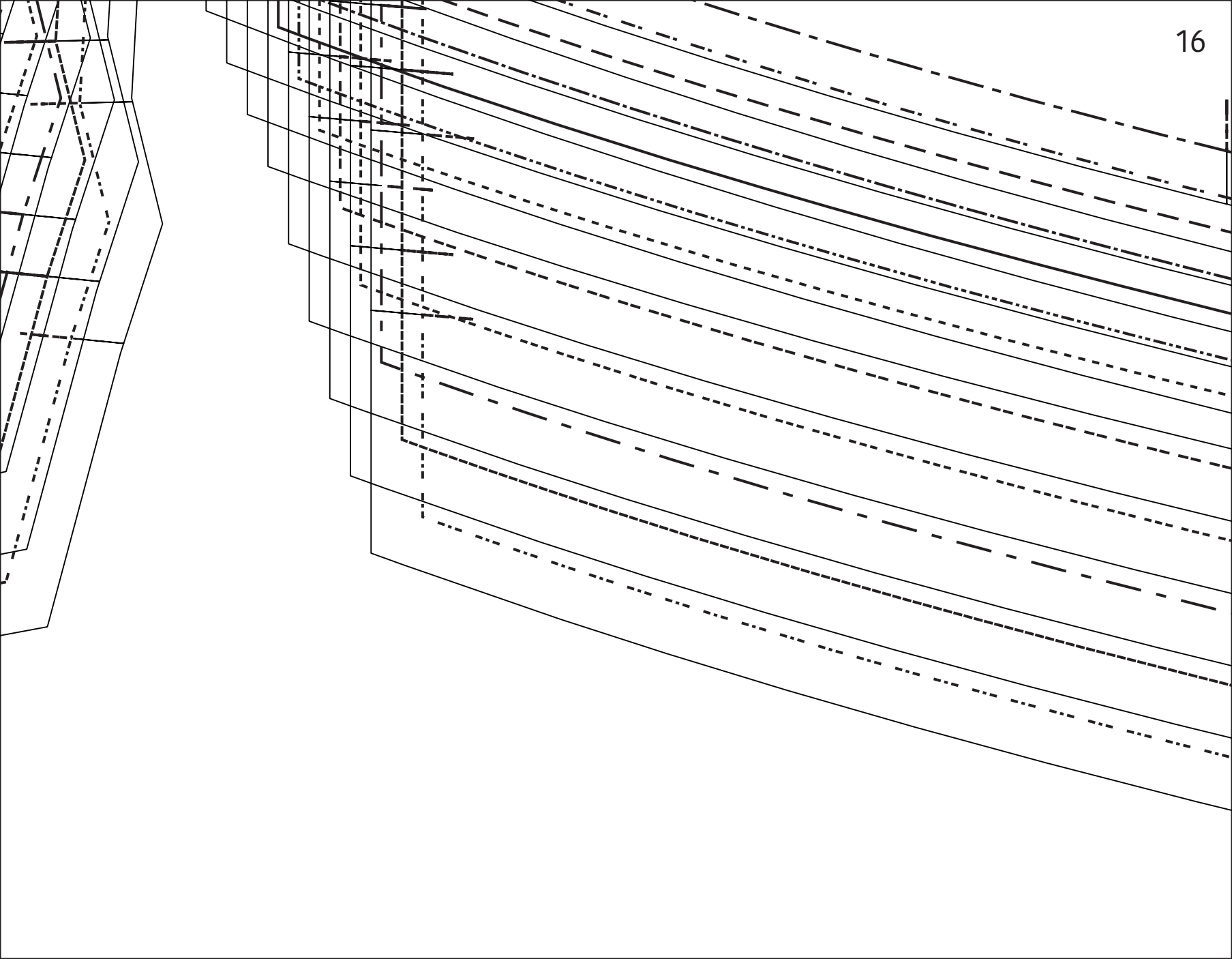

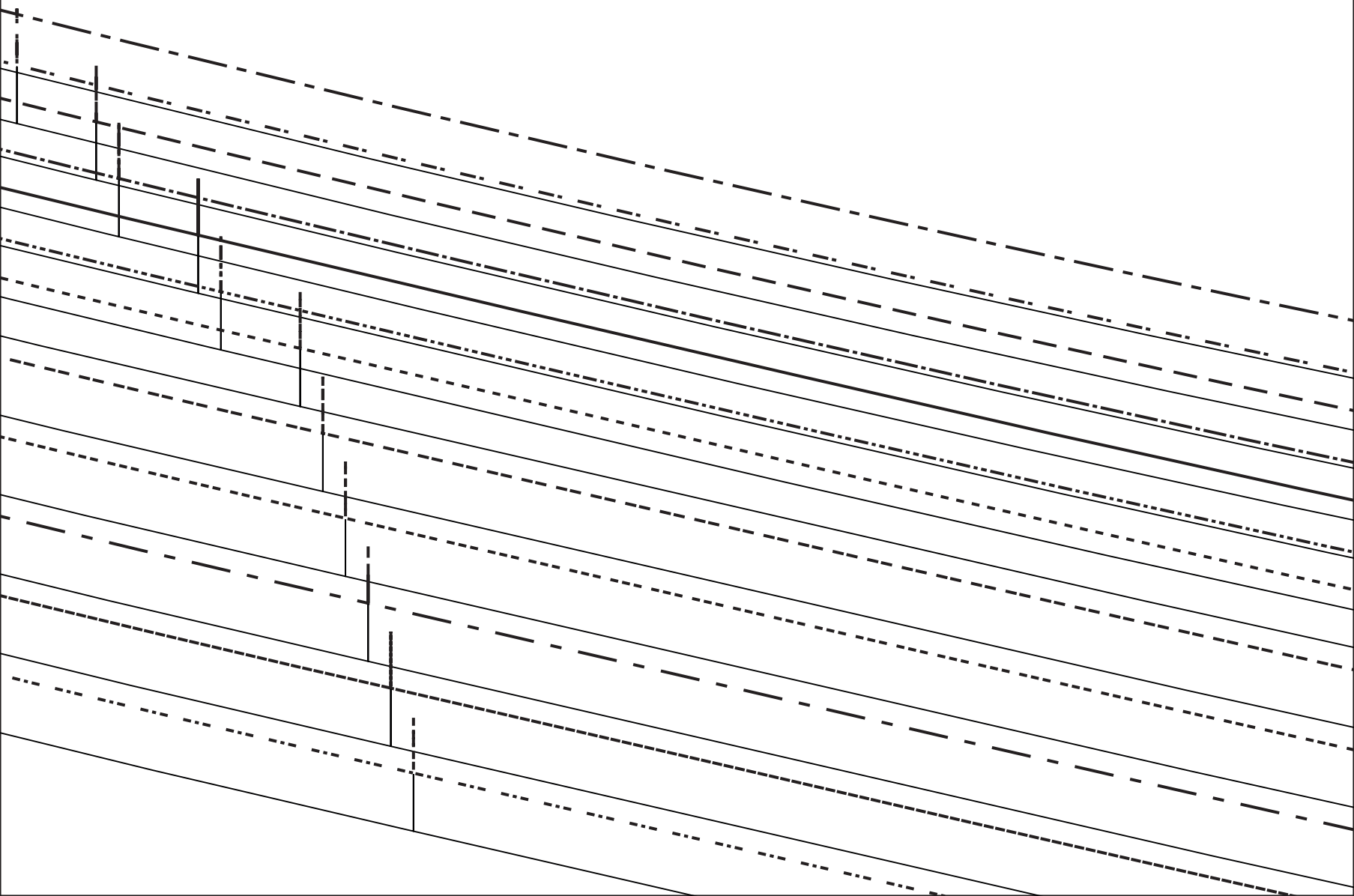

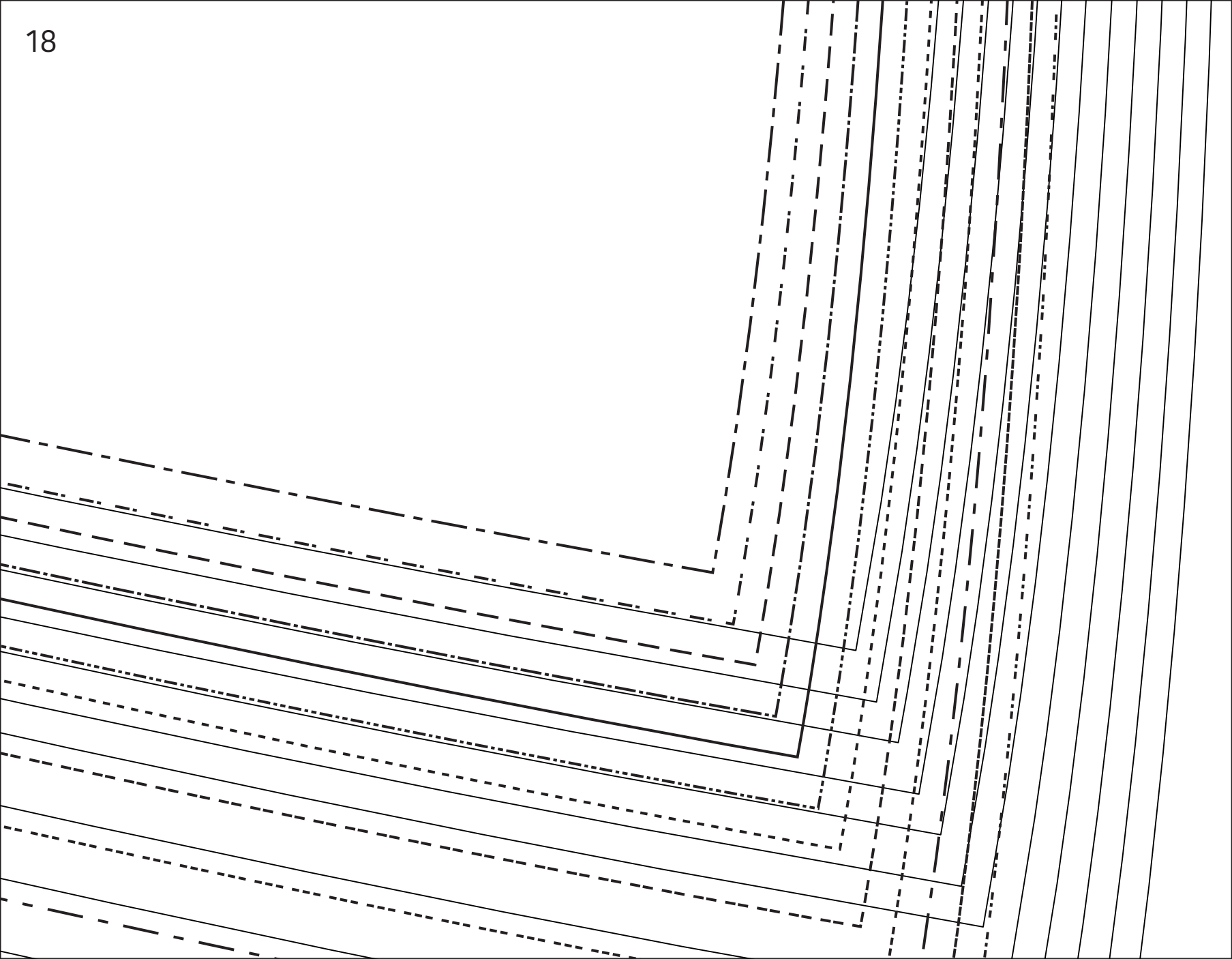

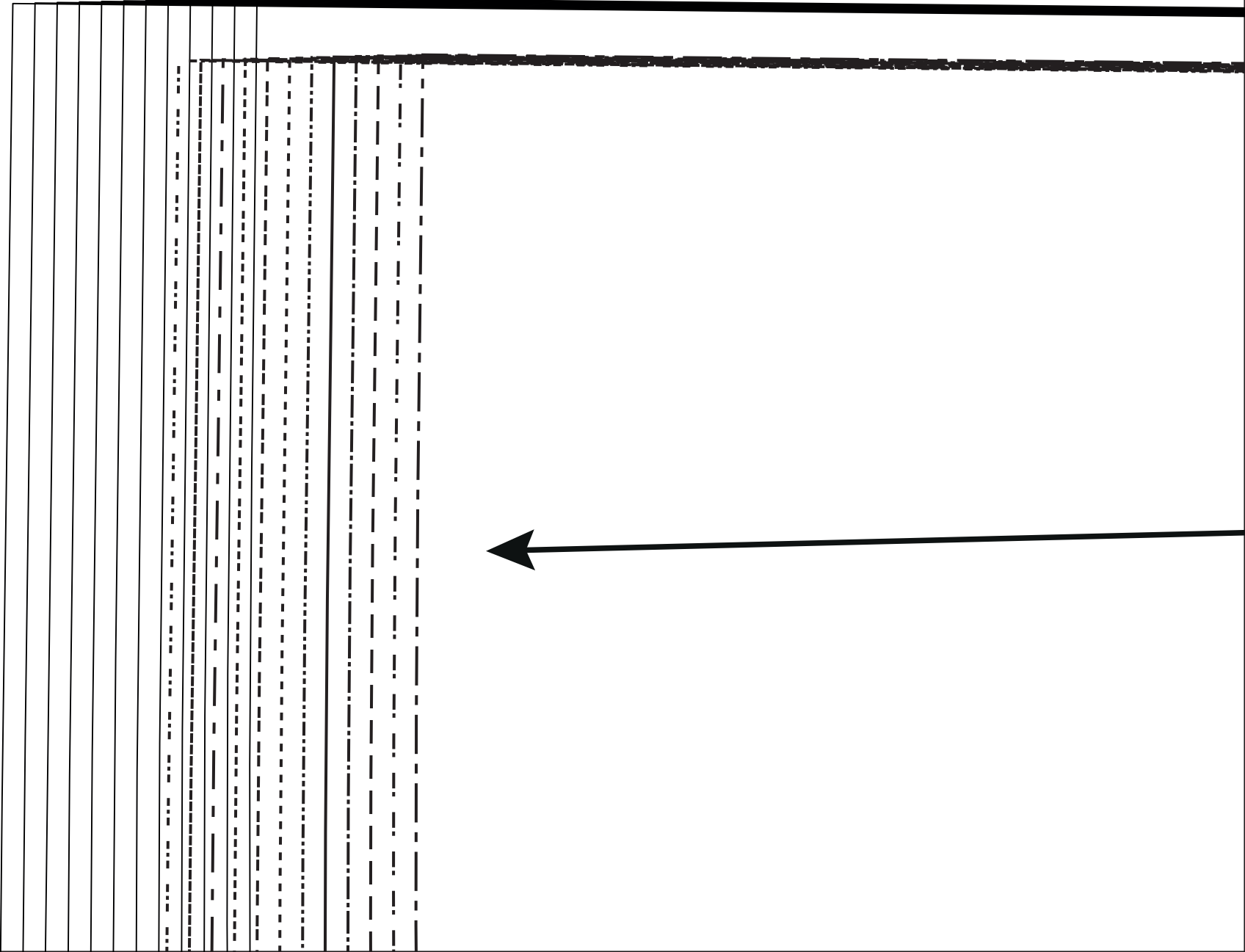

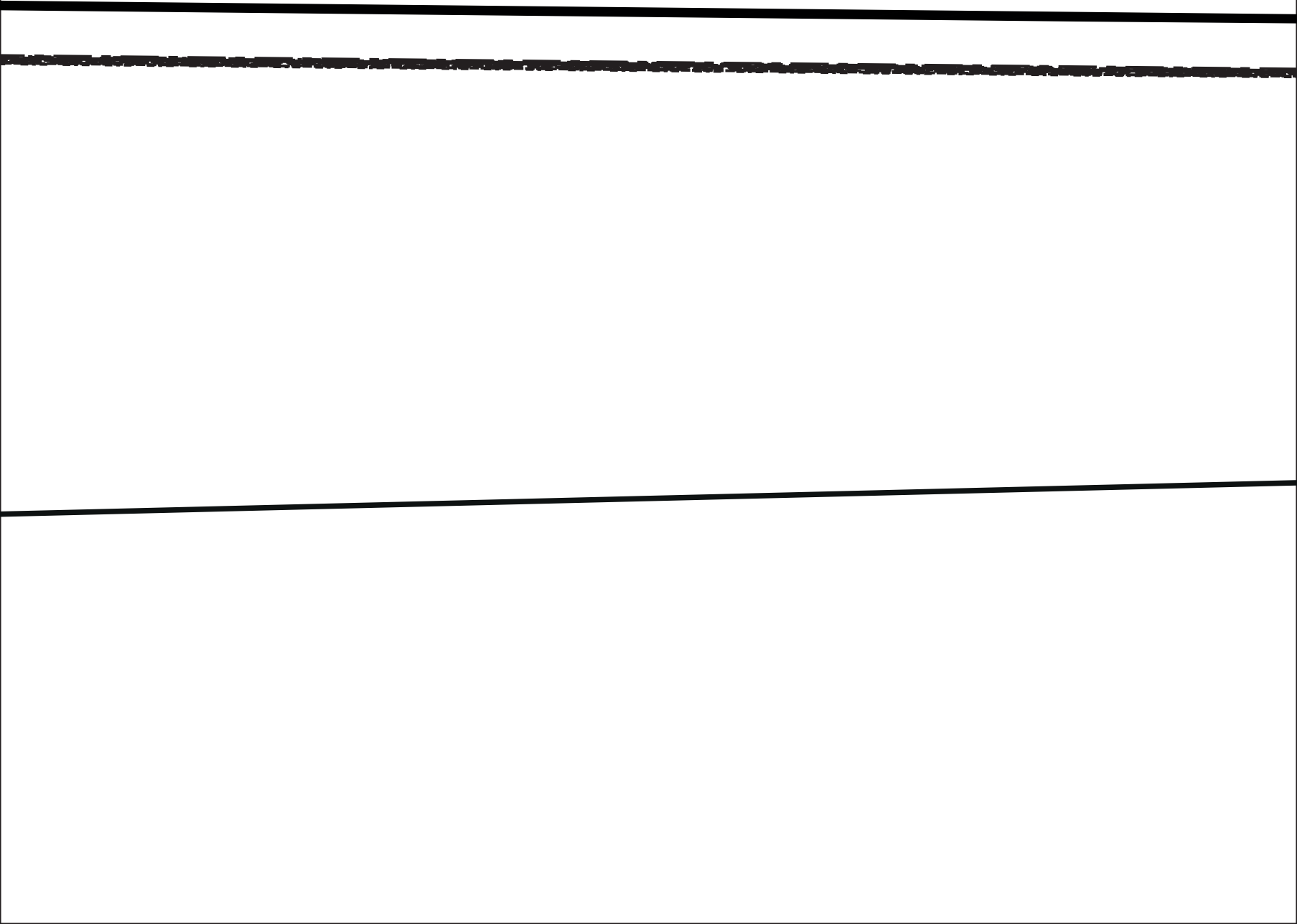

MV/MDV/CF

Victor
LA MAISON

Carline - A

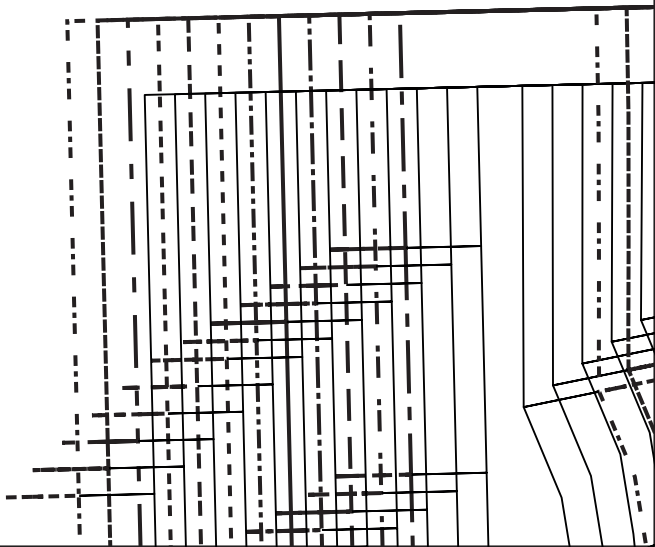

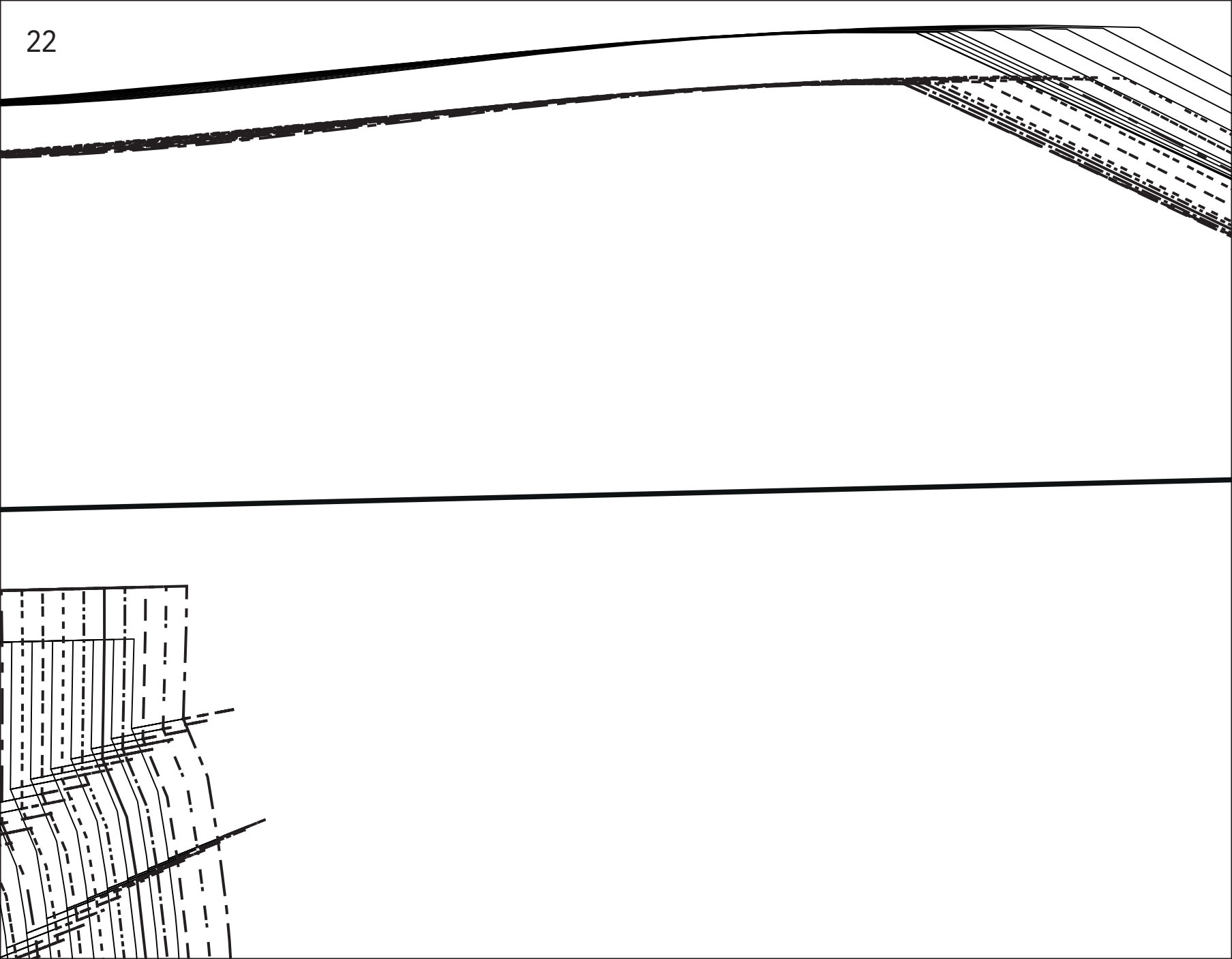

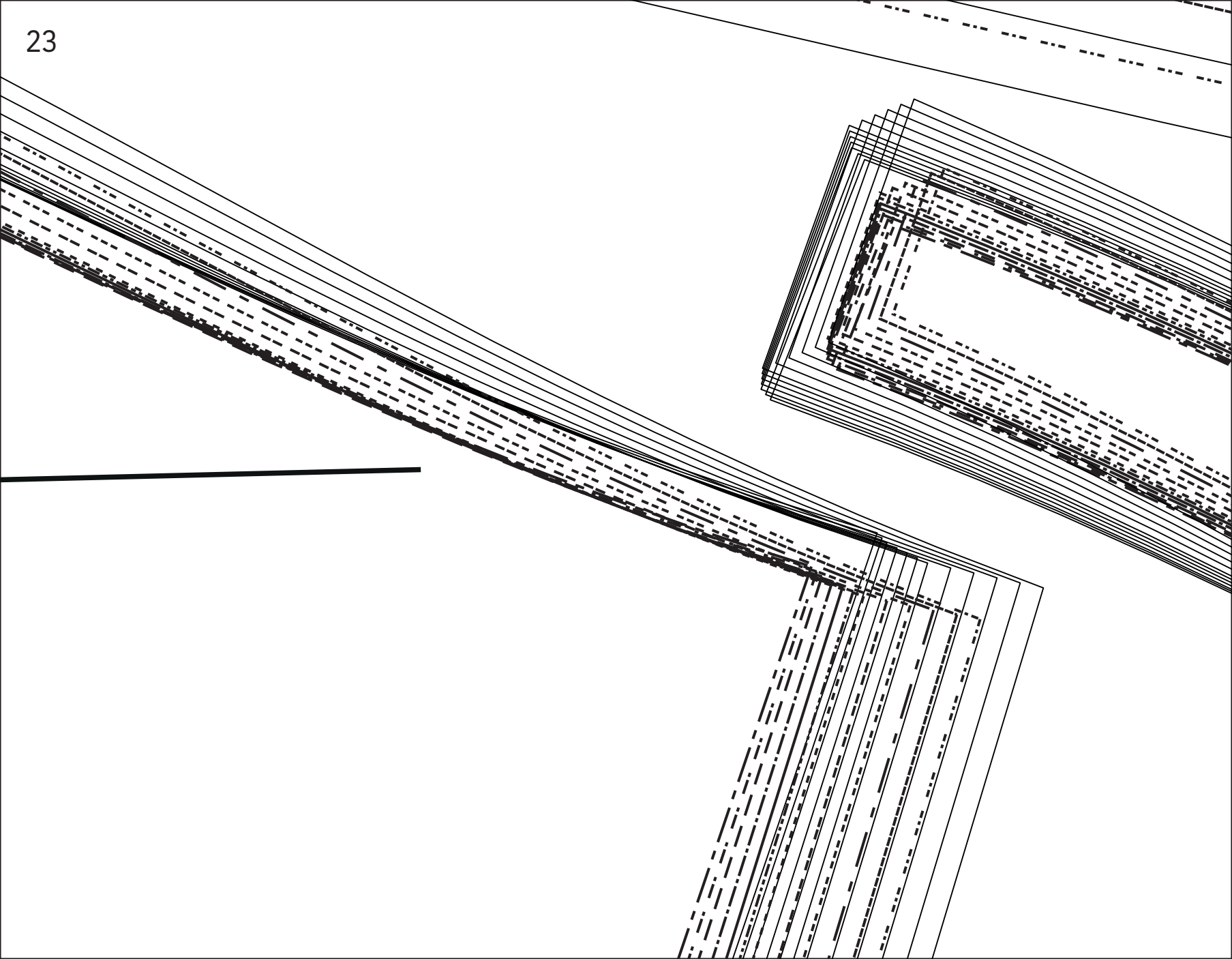

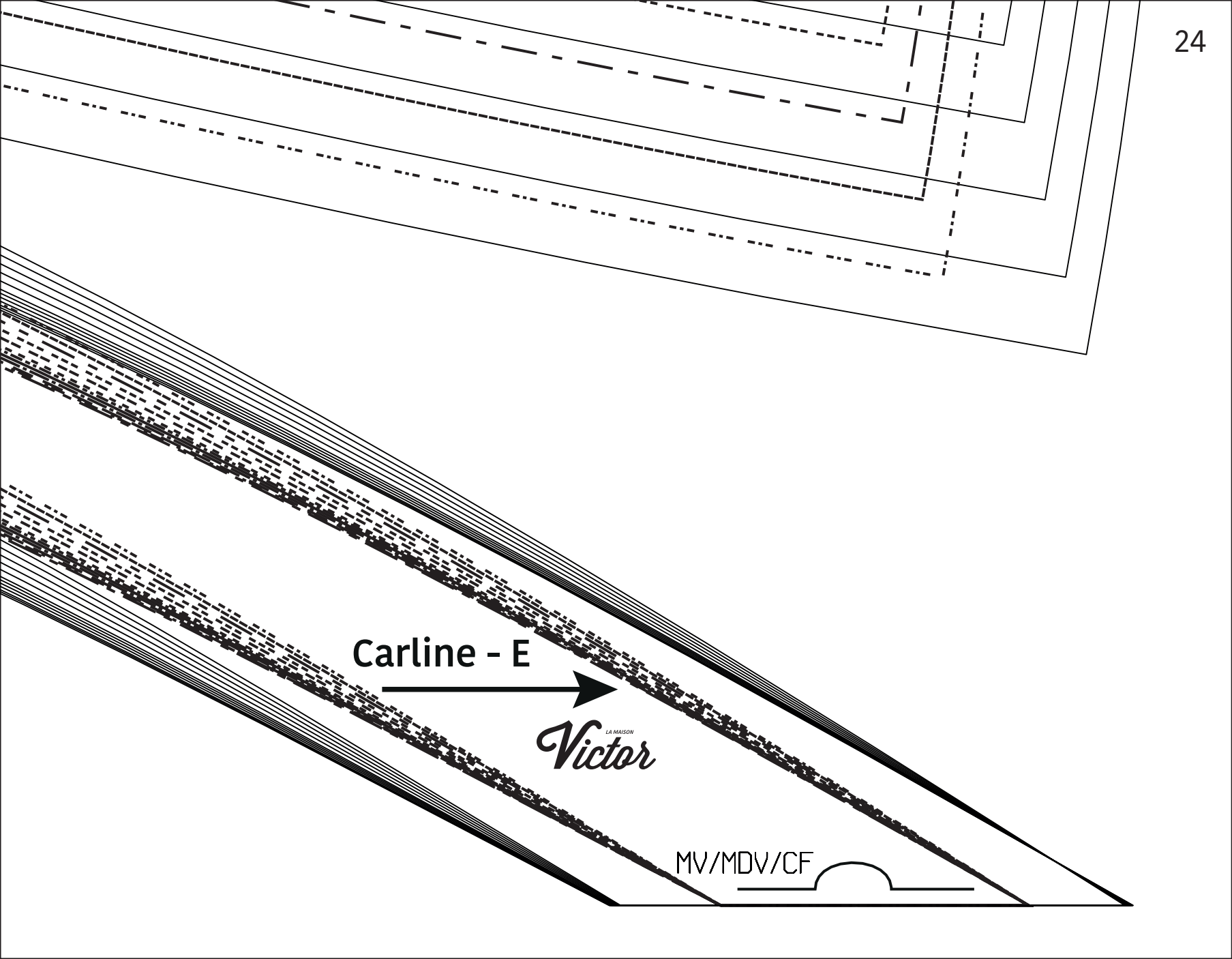

Carline - E



Victor
LA MAISON

MV/MDV/CF



