

Patroonschema / Schéma du Patron / Pattern Diagram /
Übersichtsplan zum Zusammenkleben

Kate

Rok / Jupe / Skirt

Maten / Tailles / Sizes:

.....	30
-----	32
-----	34
- . - . - . - . - . - .	36
-----	38
-----	40
-----	42
-----	44
-----	46
-----	48

Patroondelen / Pièces du patron / Pattern pieces:

- A** voorpand / devant / front panel
- B** rugpand / dos / back panel
- C** tailleband / ceinture / waistband

1	2	3	4	5	6
7	8	9	10	11	12
13	14	15	16	17	18
19	20	21	22	23	24

Controlevierkant / Carré de controle
/ Test square / Kontrollquadrat

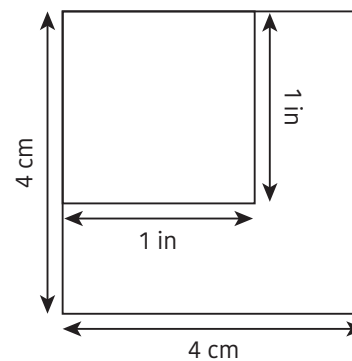

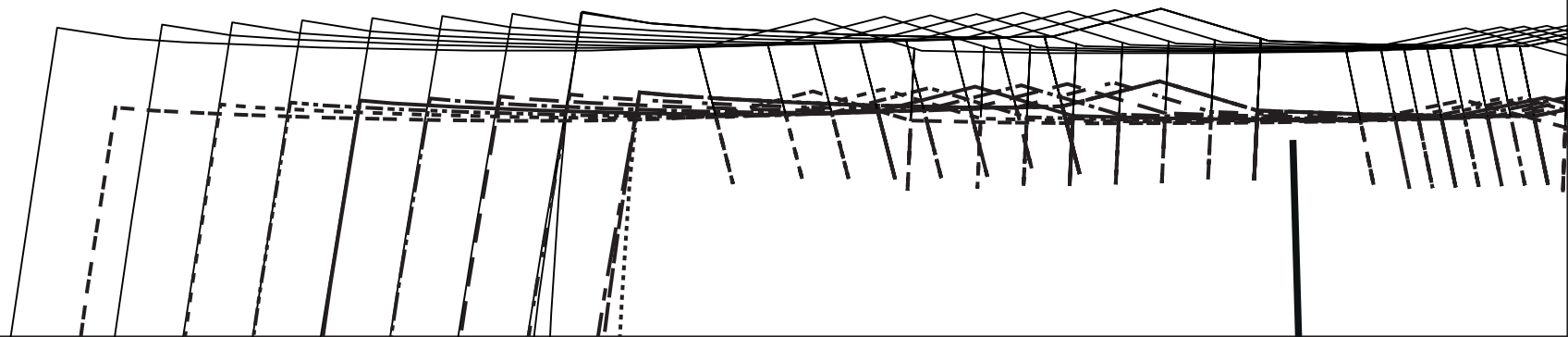

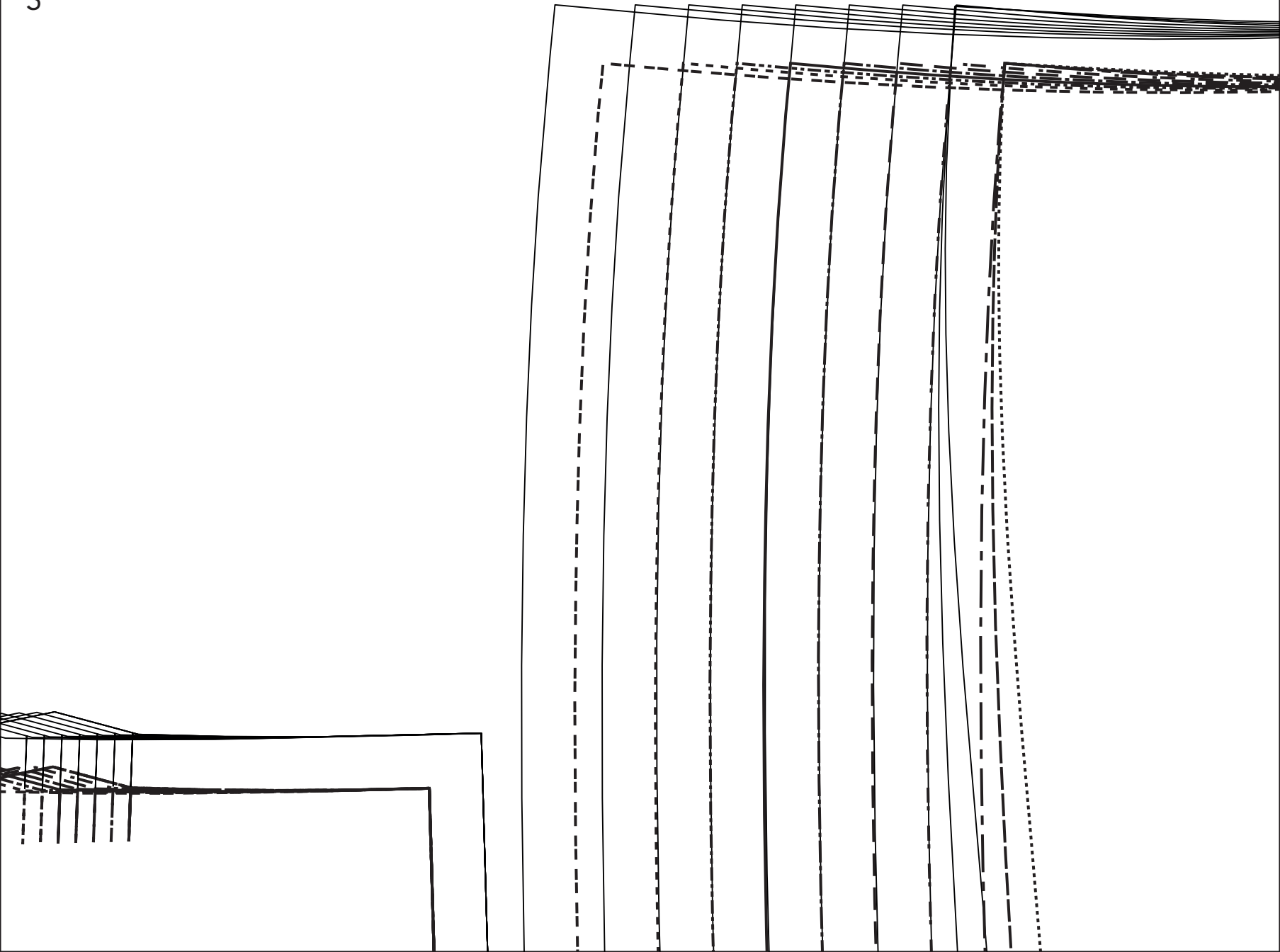

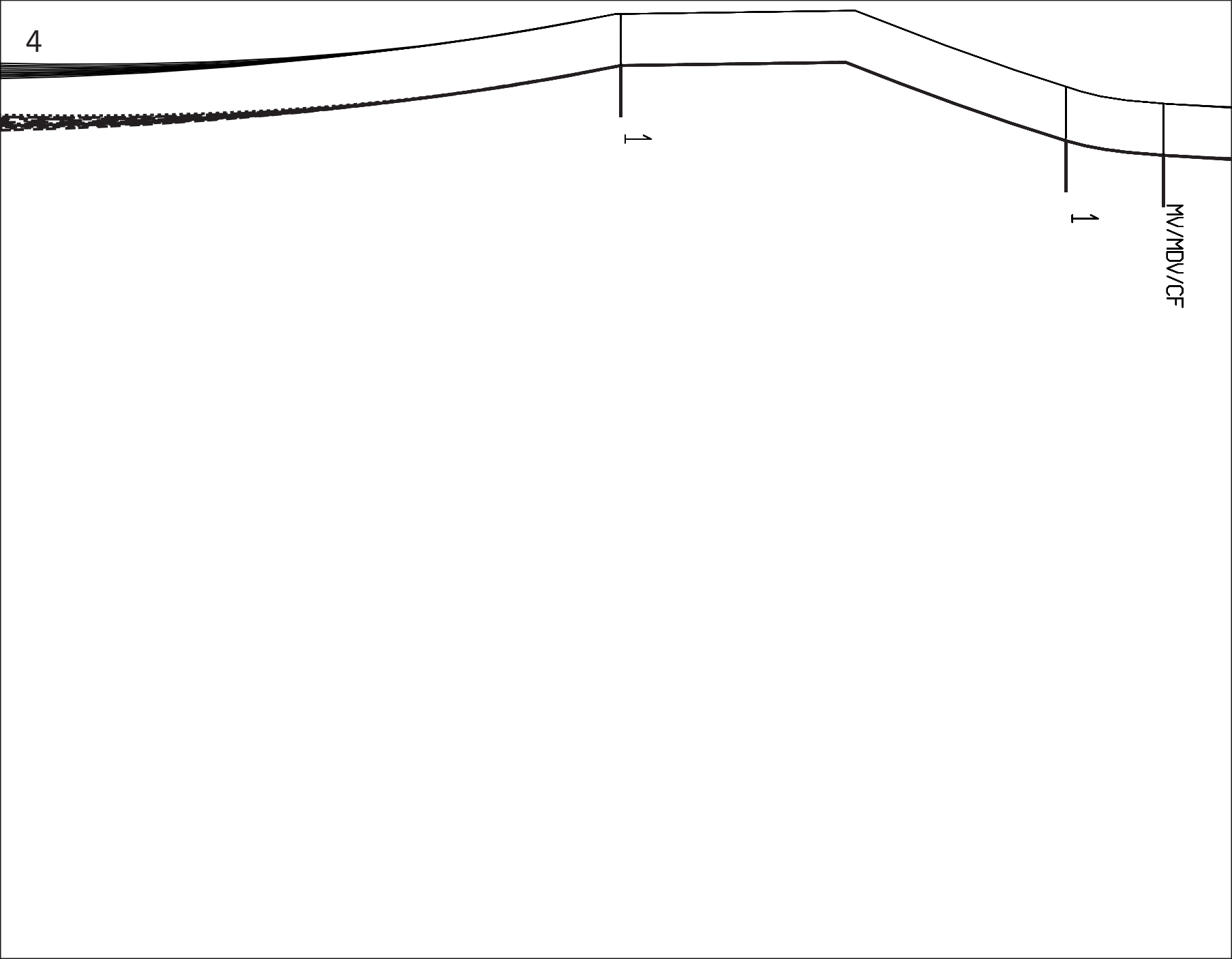

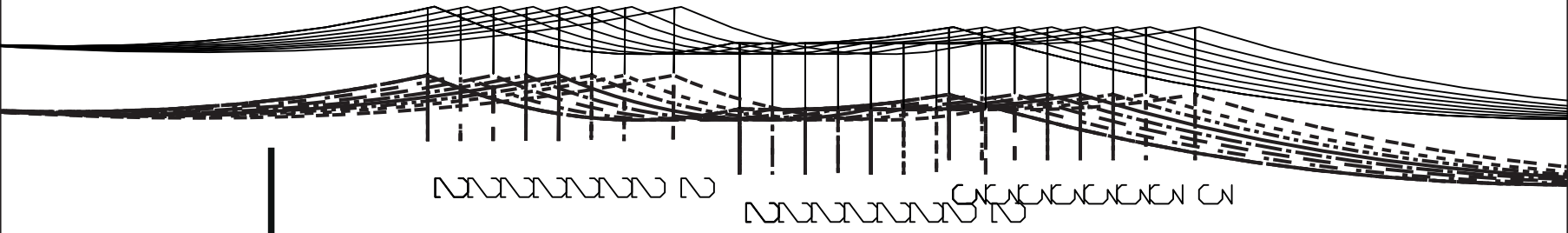

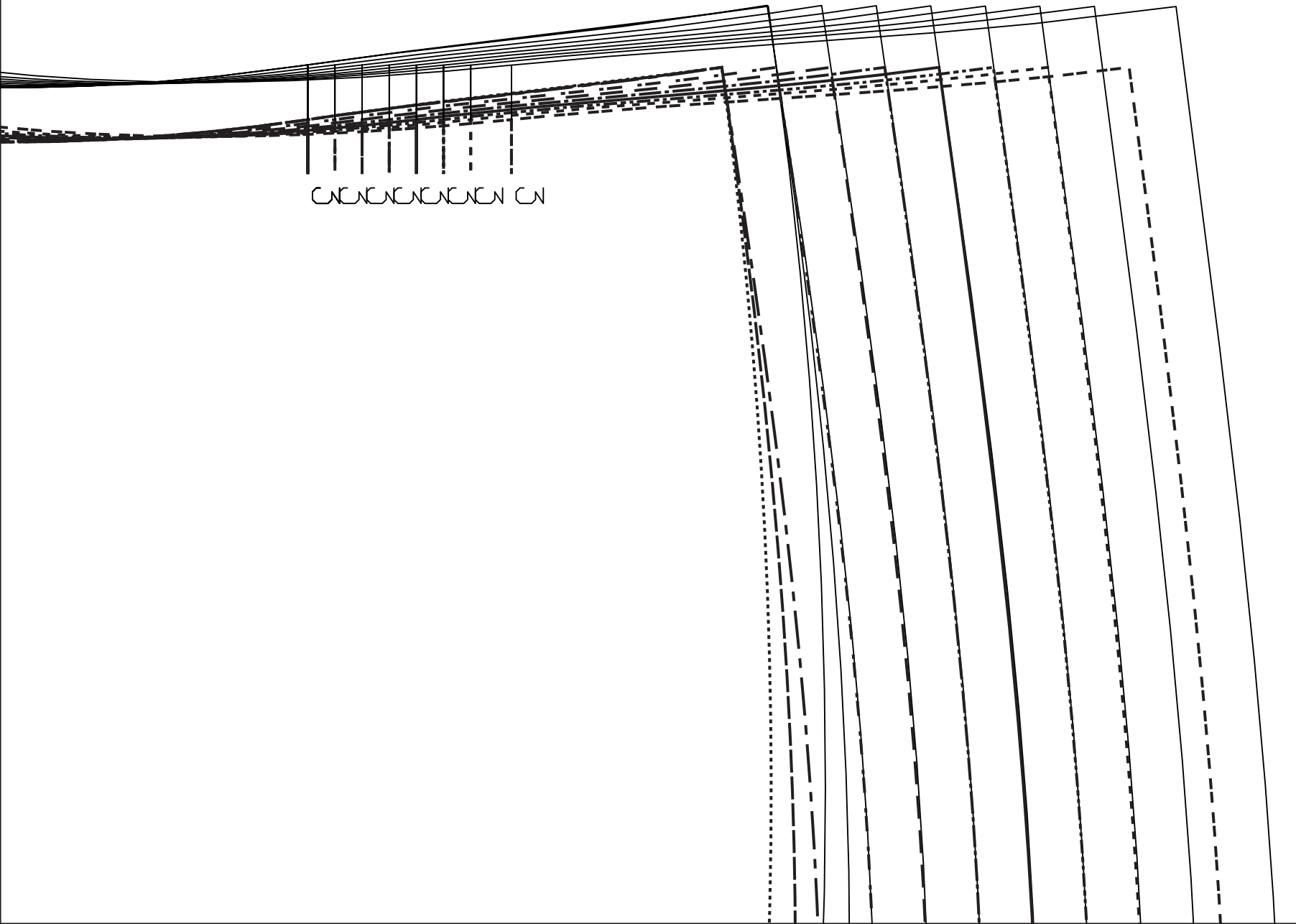



Kate

Victor
LA MAIN

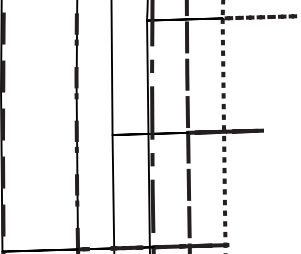



MR/MDS/CB

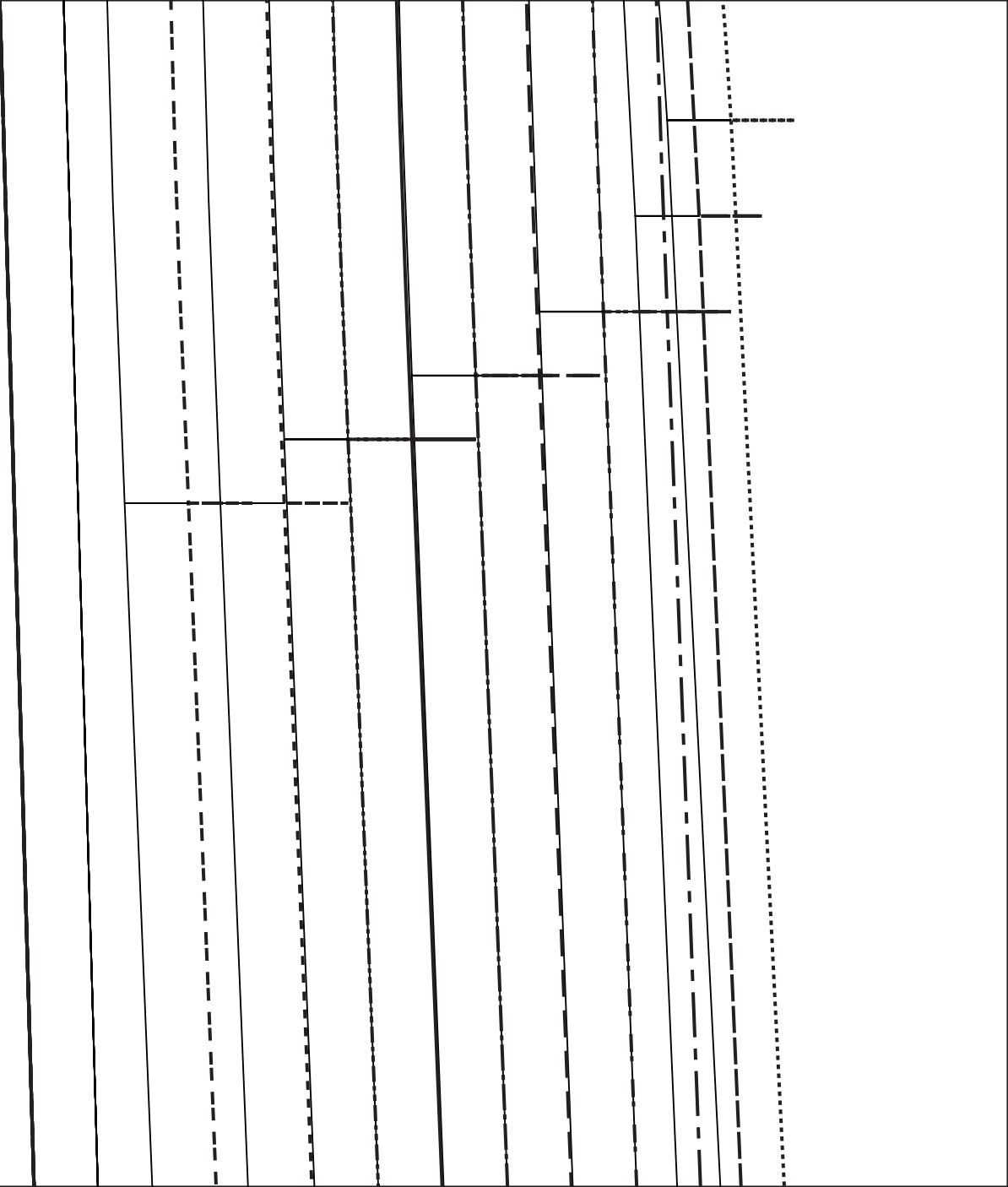

Kate - A

Victoria
LA MAISON

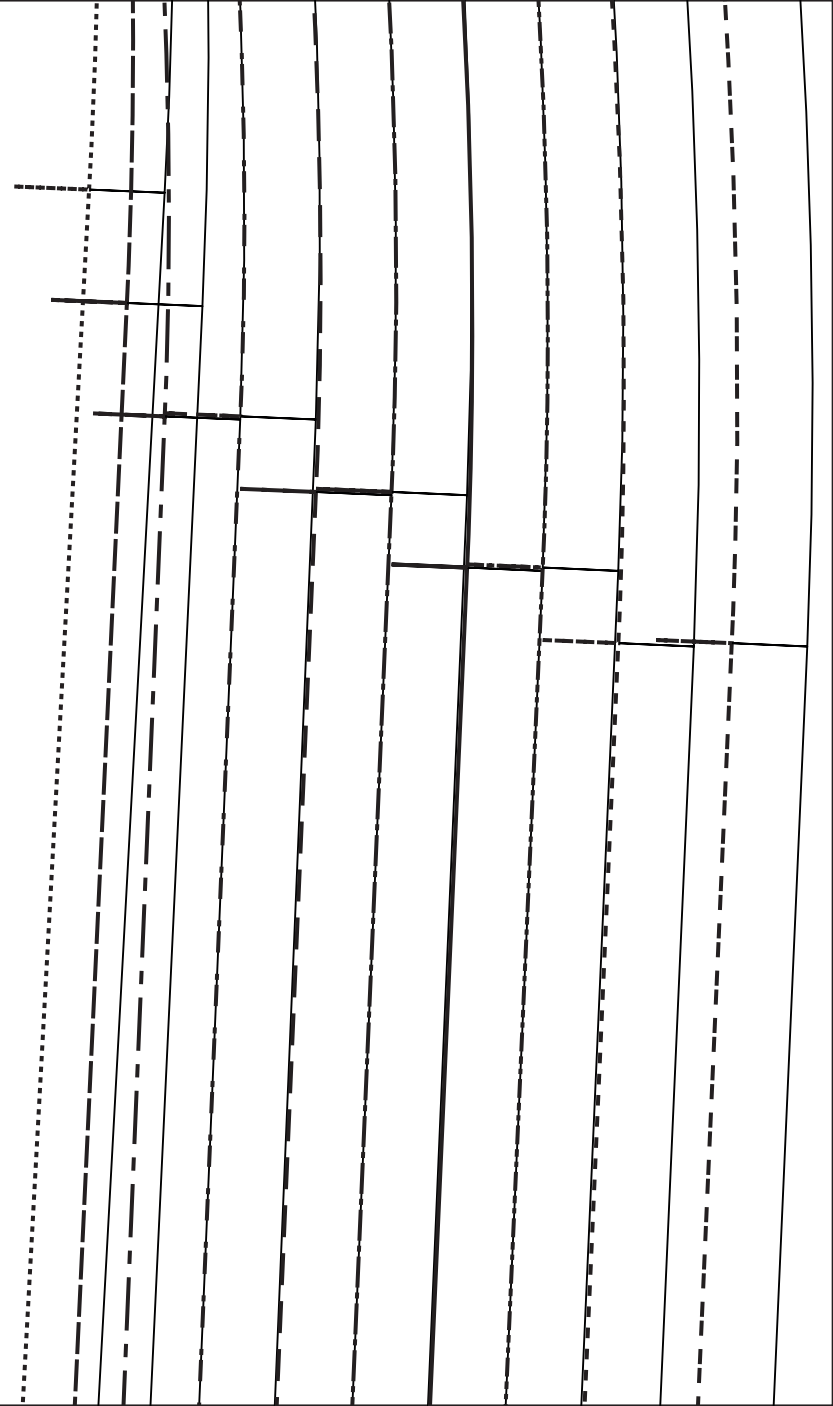

- B

NO

25

14

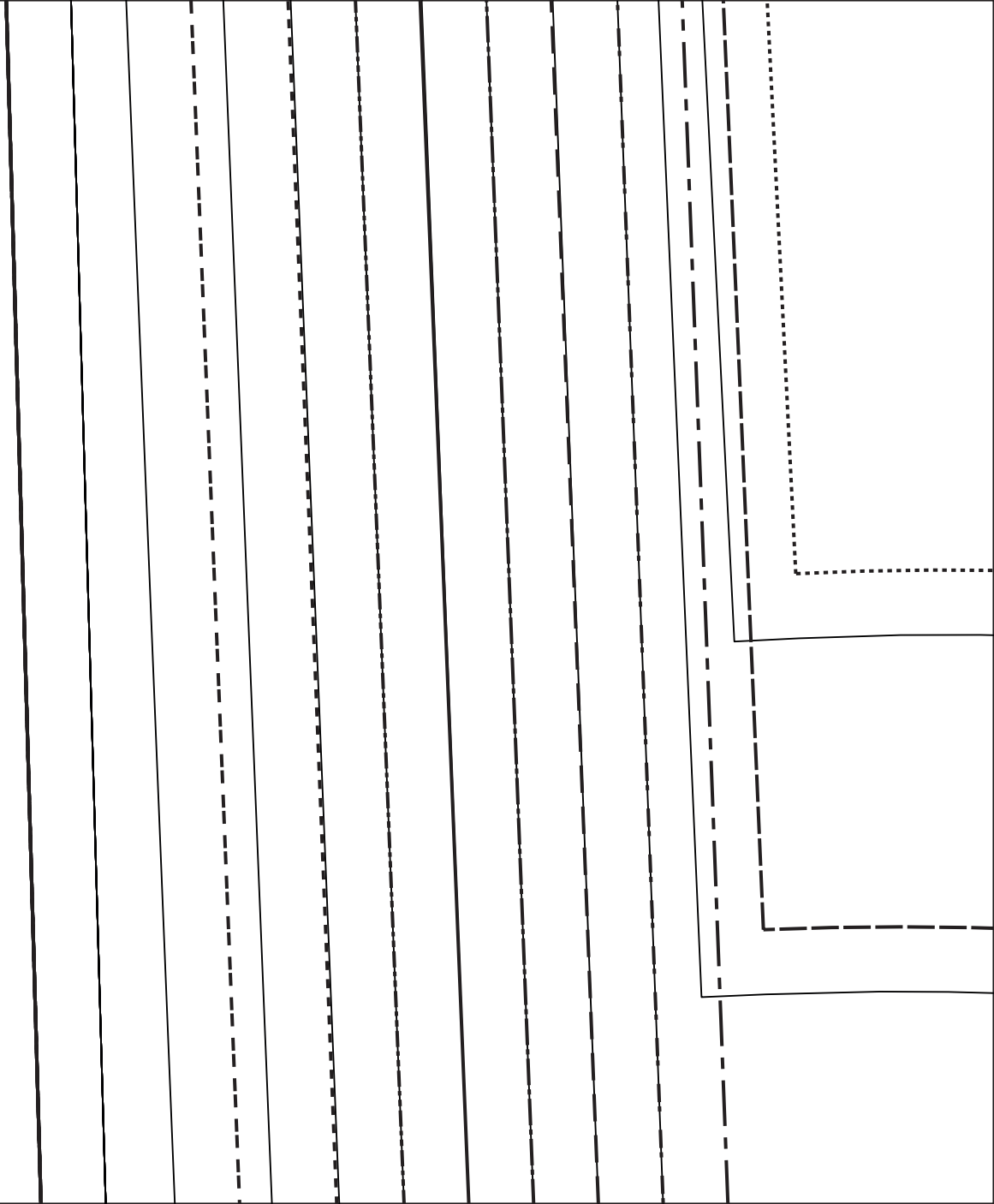

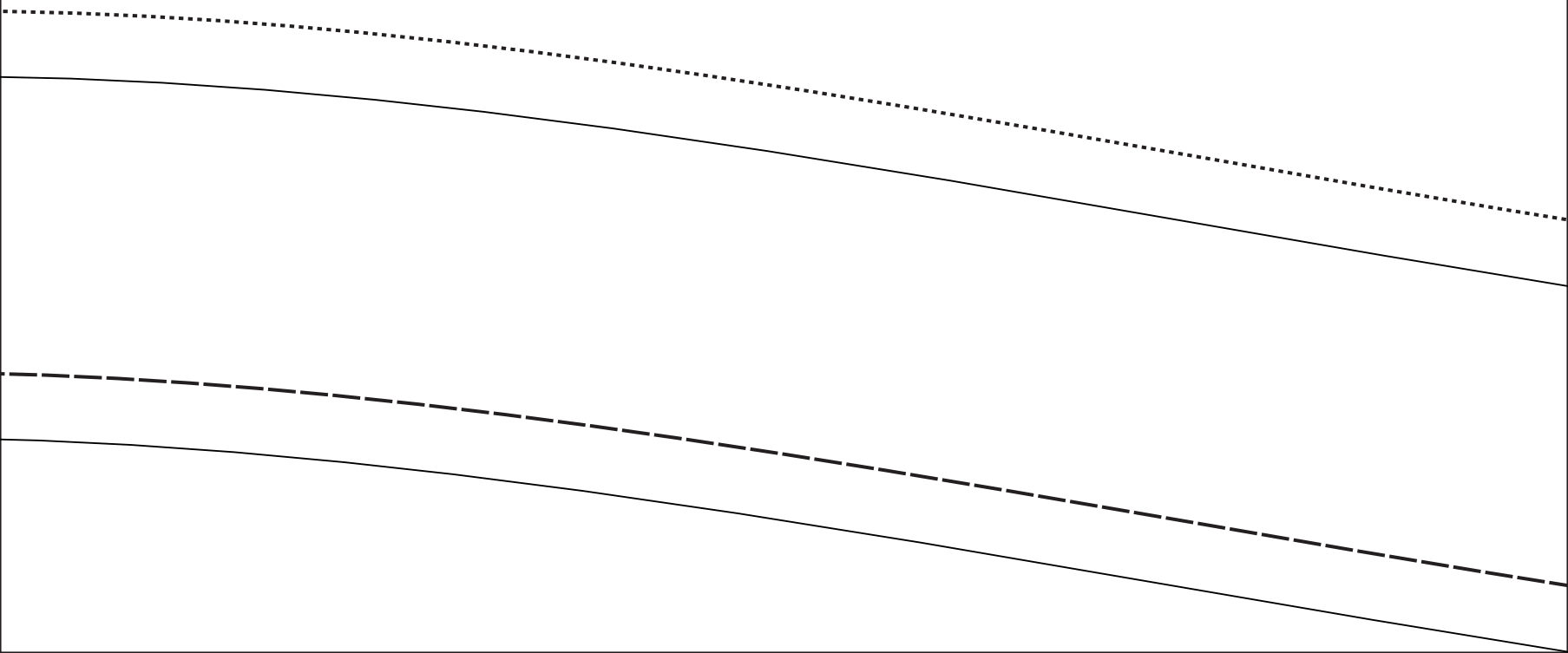

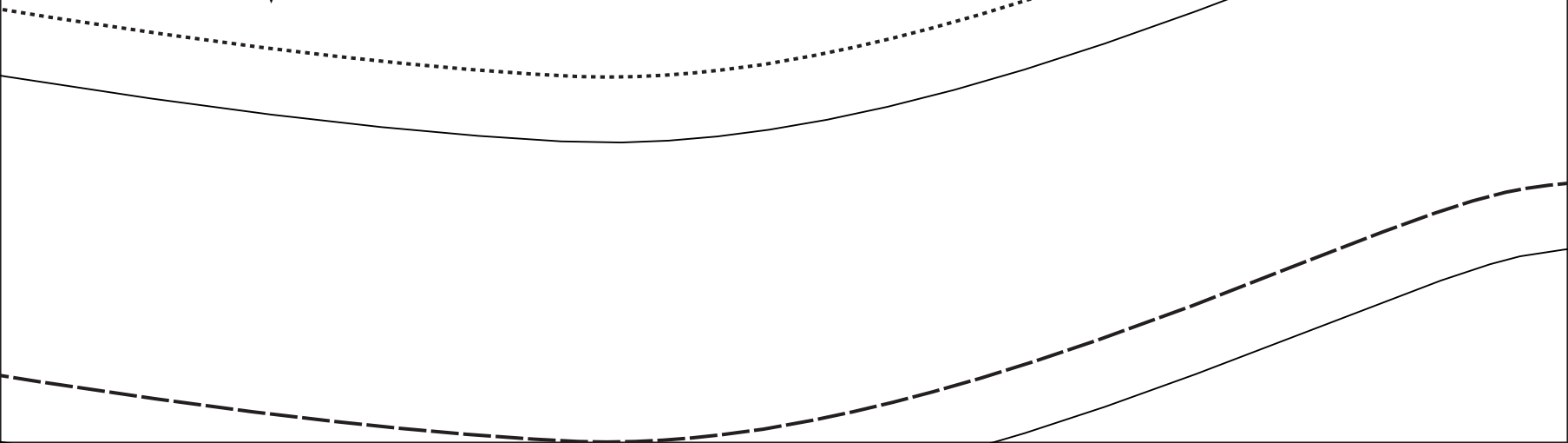

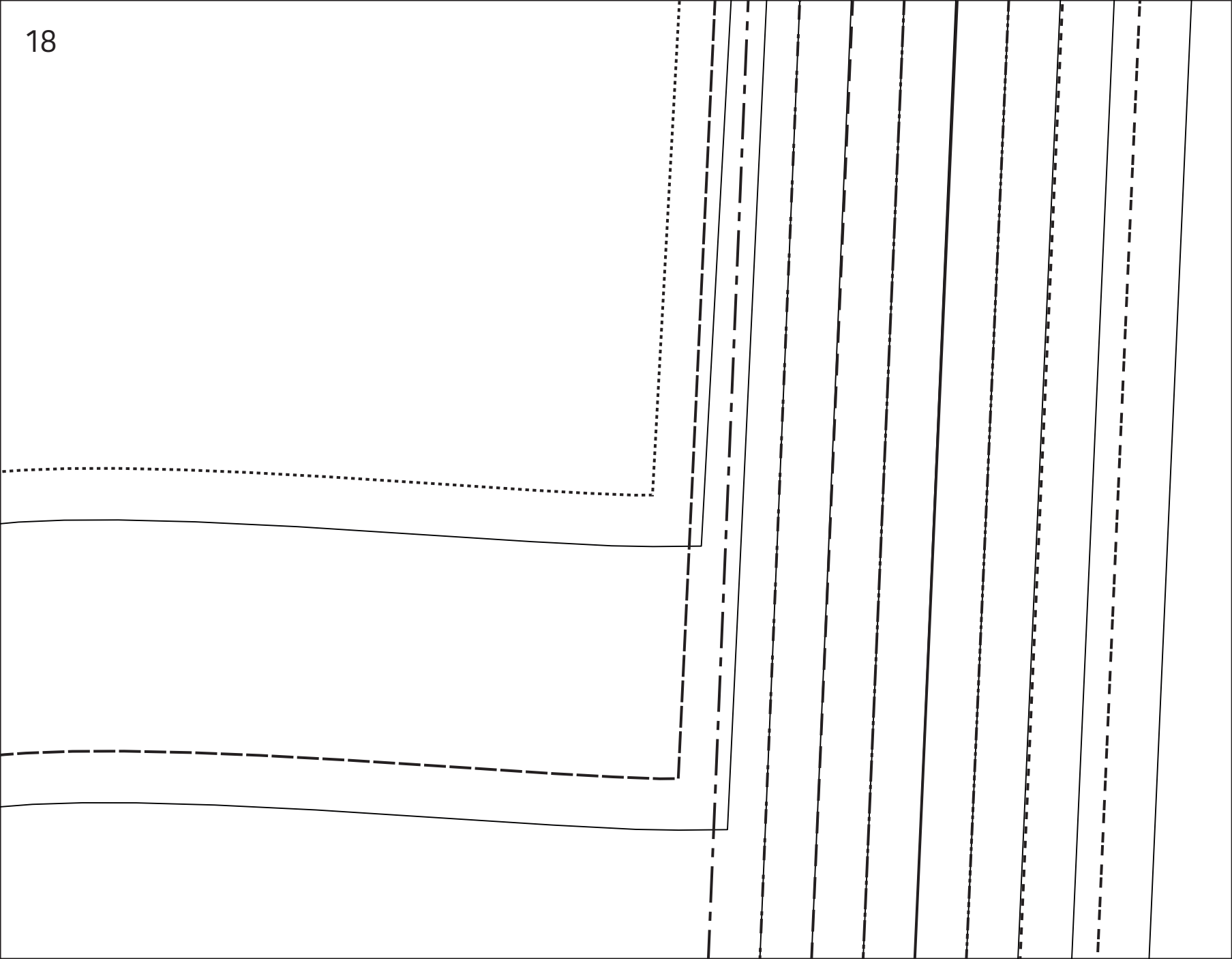

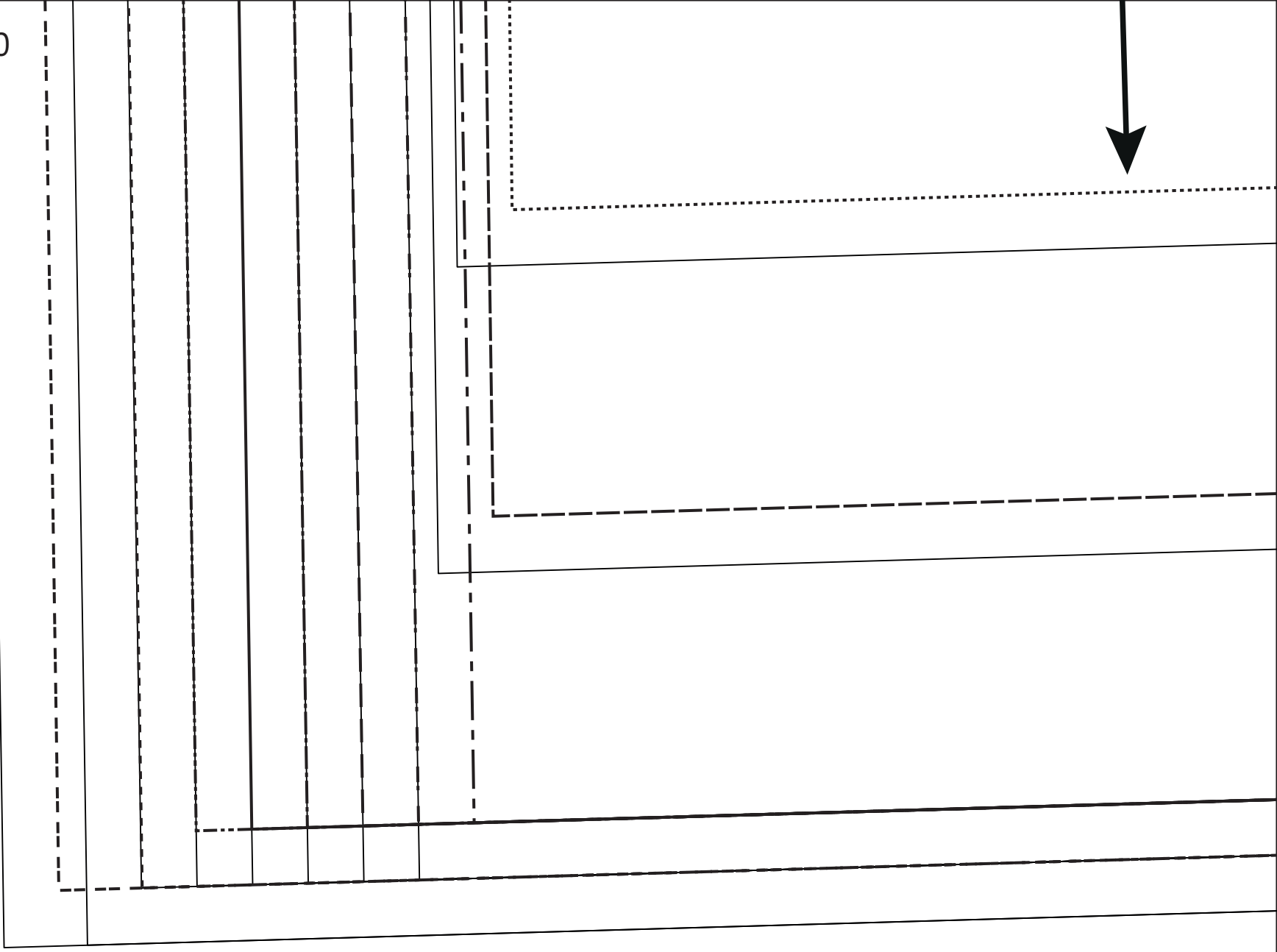

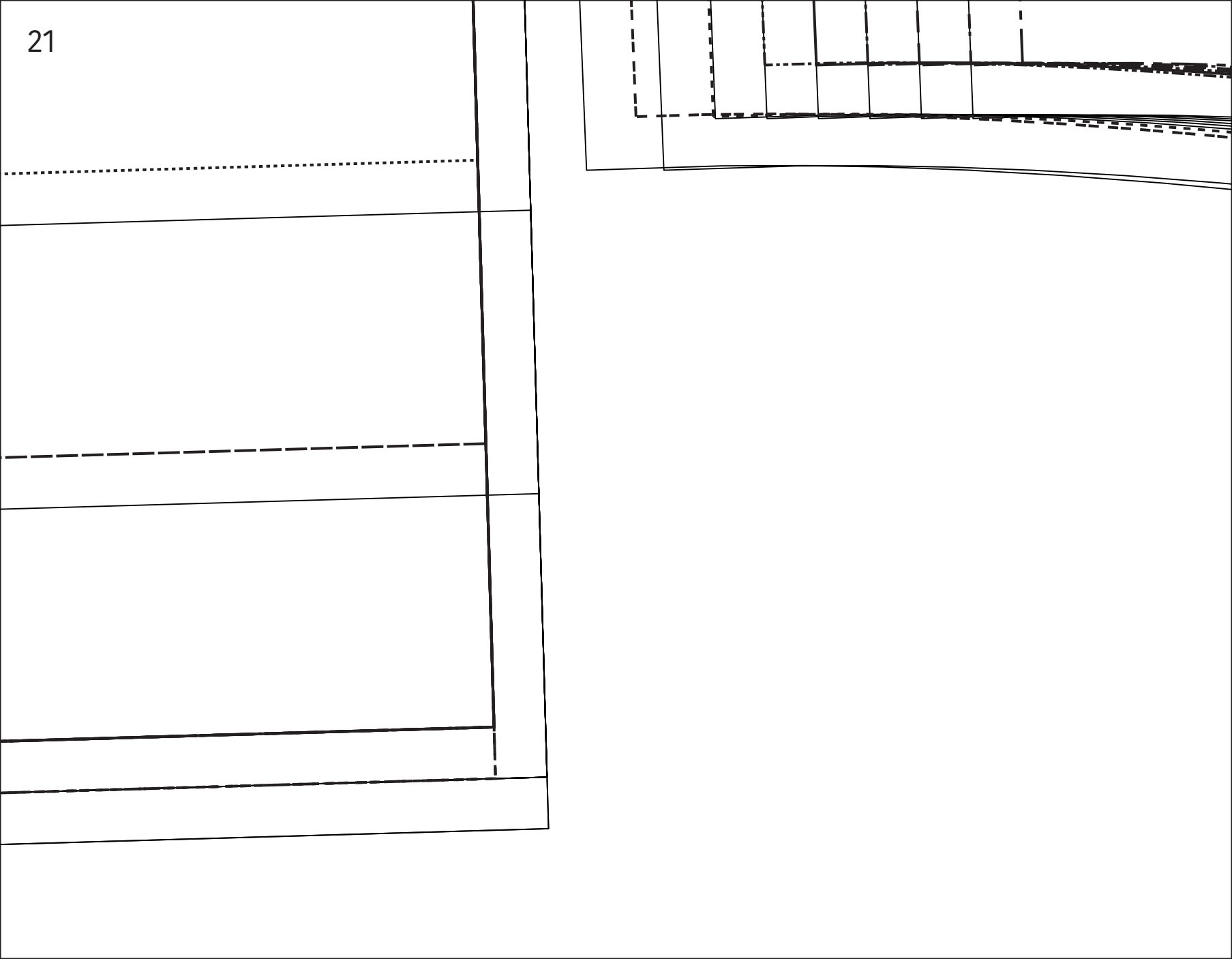

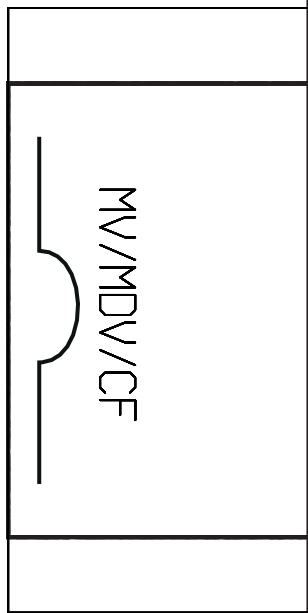
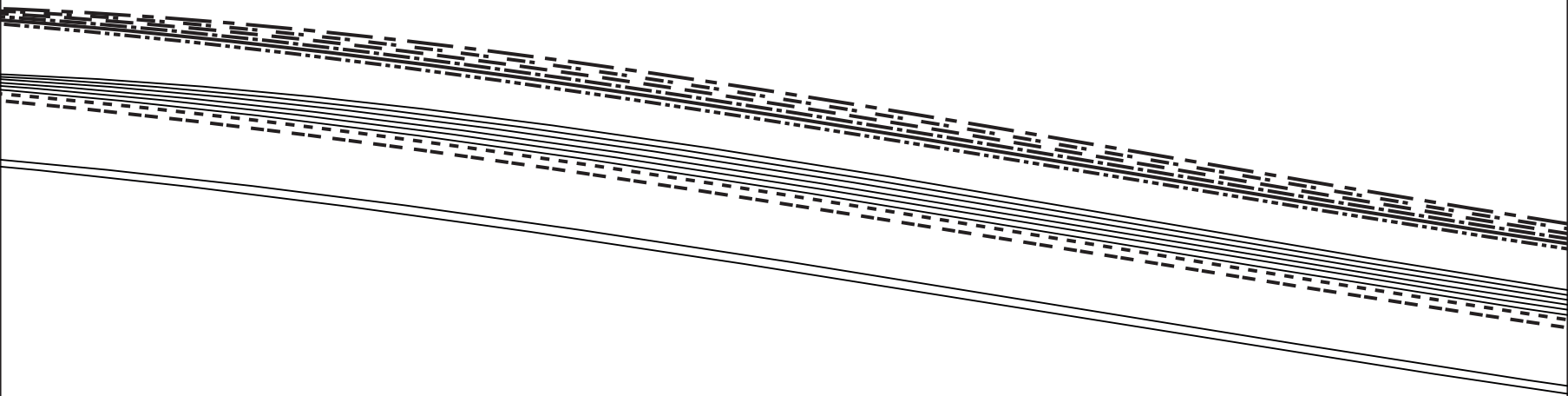

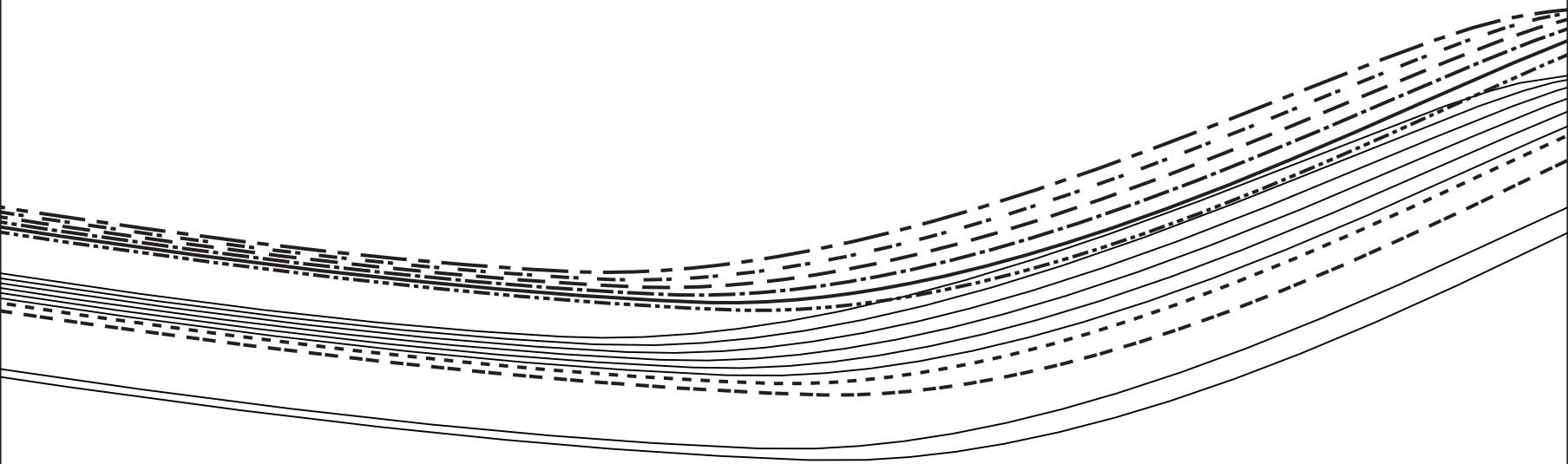

Victor
LA MAISON

Kate - C

