

# Fauve

## Top

### Maten / Tailles / Sizes / Größen:

.....	34
-----	36
-----	38
-----	40
-----	42
-----	44
-----	46
-----	48

### Patroondelen / Pièces du patron / Pattern pieces / Schnittteile:

- A** voorpand / devant / front panel /  
Vorderteil
- B** rugpand / dos / back panel /  
Rückenteil
- C** halsbeleg VP / parementure  
d'encolure du devant / neckline  
facing front panel / Halsbeleg VT
- D** halsbeleg RP / parementure  
d'encolure du dos / neckline facing  
back panel / Halsbeleg RT
- E** beleg armuitsnijding VP /  
parementure d'emmanchure du  
devant / arm facing front /  
Beleg Armausschnitt VT
- F** beleg armuitsnijding RP /  
parementure d'emmanchure du dos /  
arm facing back /  
Beleg Armausschnitt RT

## Patroonschema / Schéma du Patron / Pattern Diagram / Übersichtsplan zum Zusammenkleben

1	2	3	4	5	6
7	8	9	10	11	12
13	14	15	16	17	18
19	20	21	<del>22</del>	<del>23</del>	<del>24</del>
25	26	27			

### Controlevierkant / Carré de controle / Test square / Kontrollquadrat

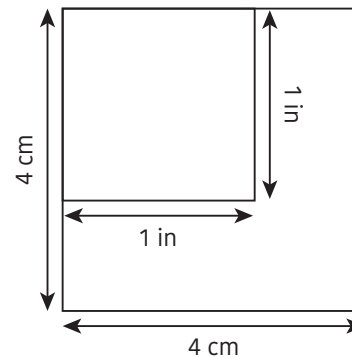

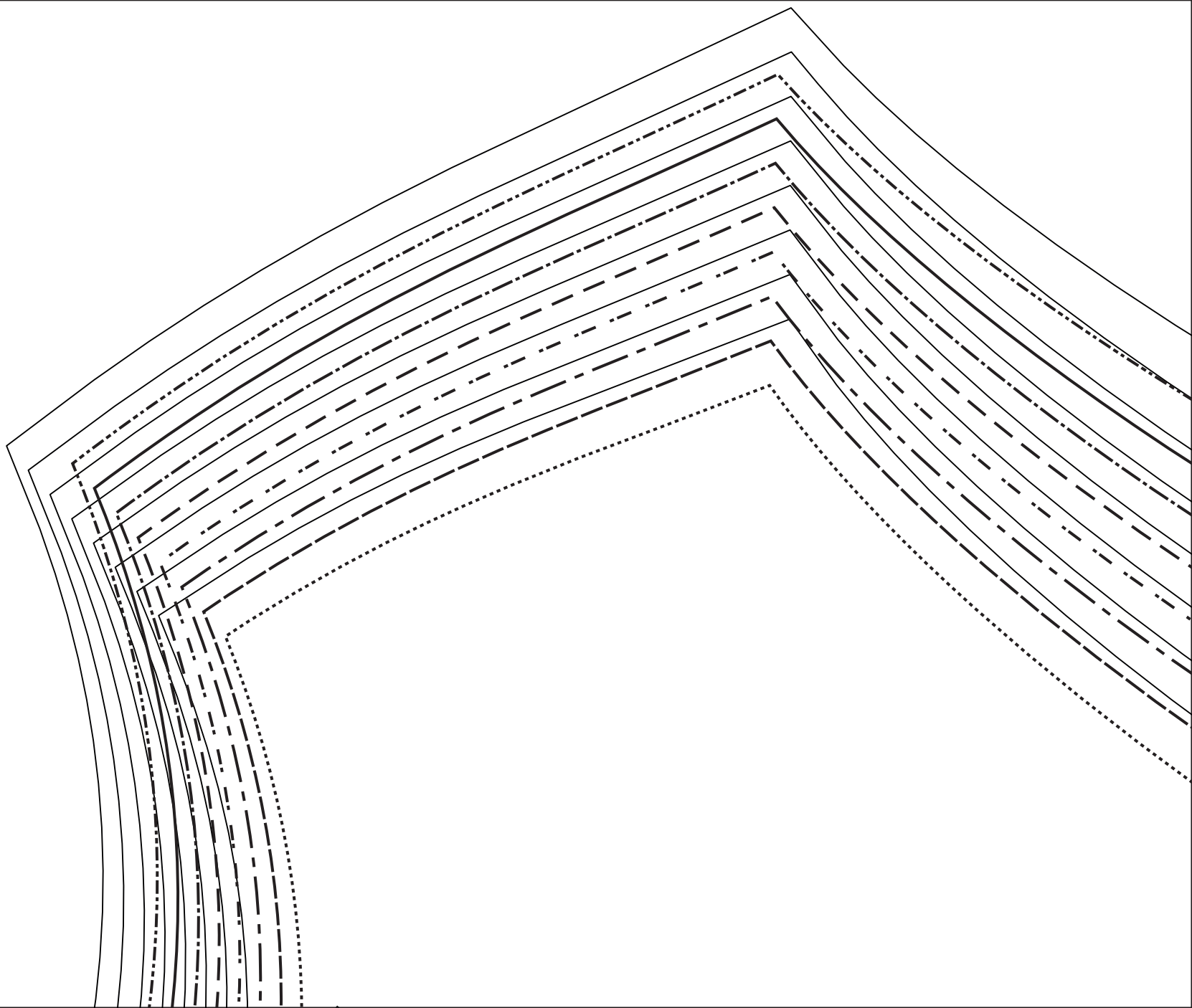

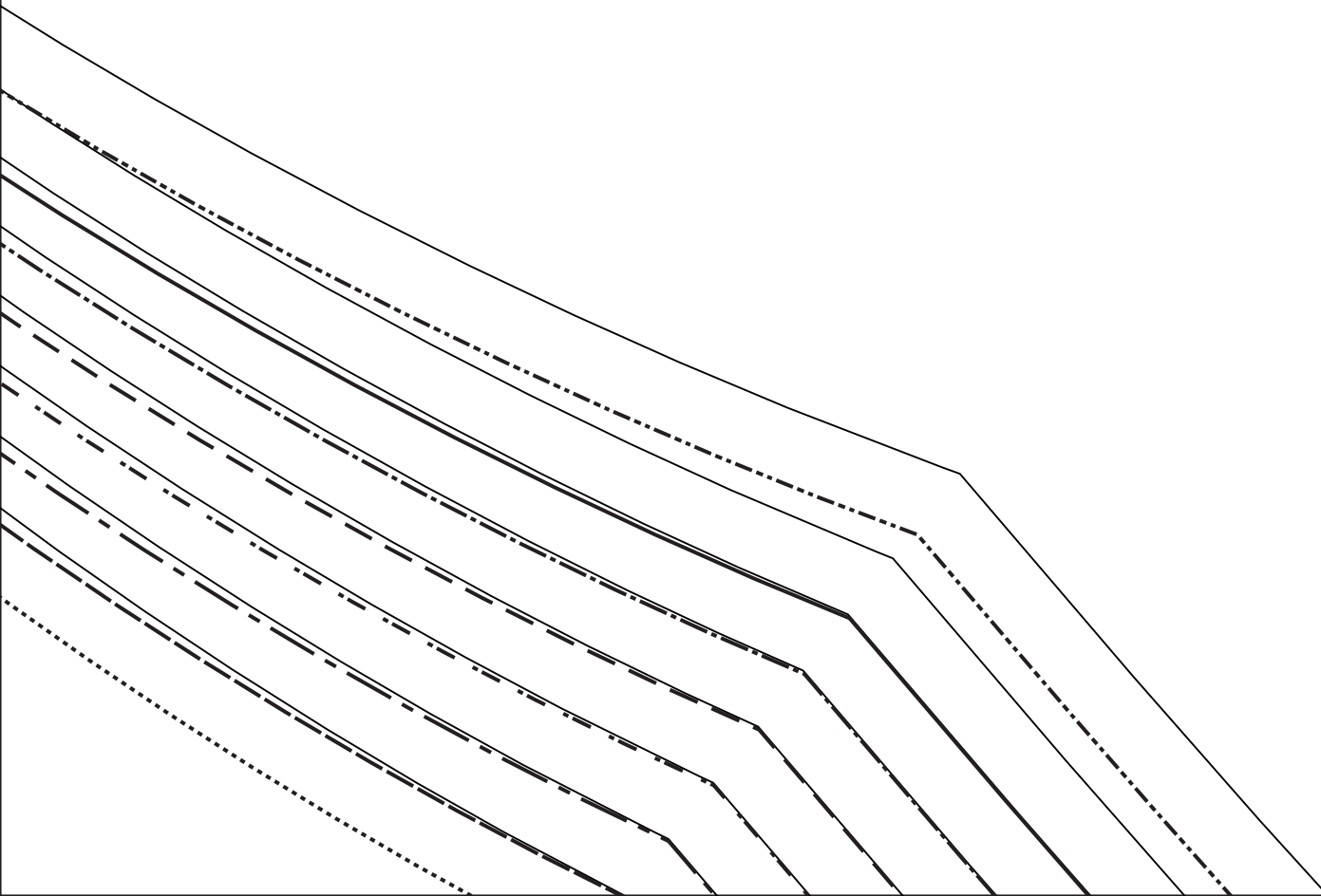

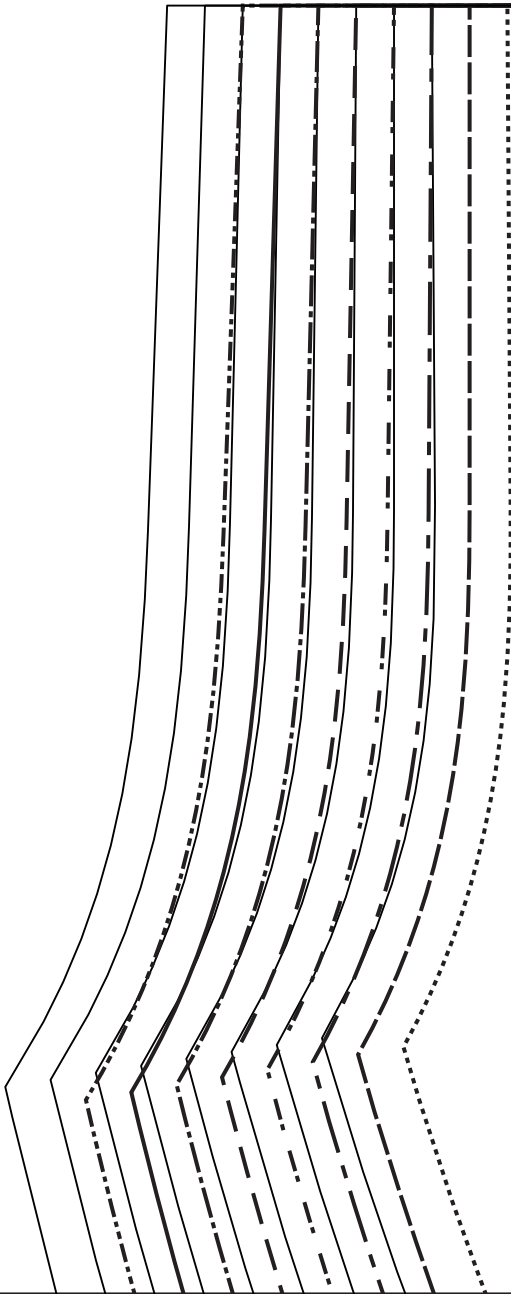



MR/MDS/CB/RM

**B**

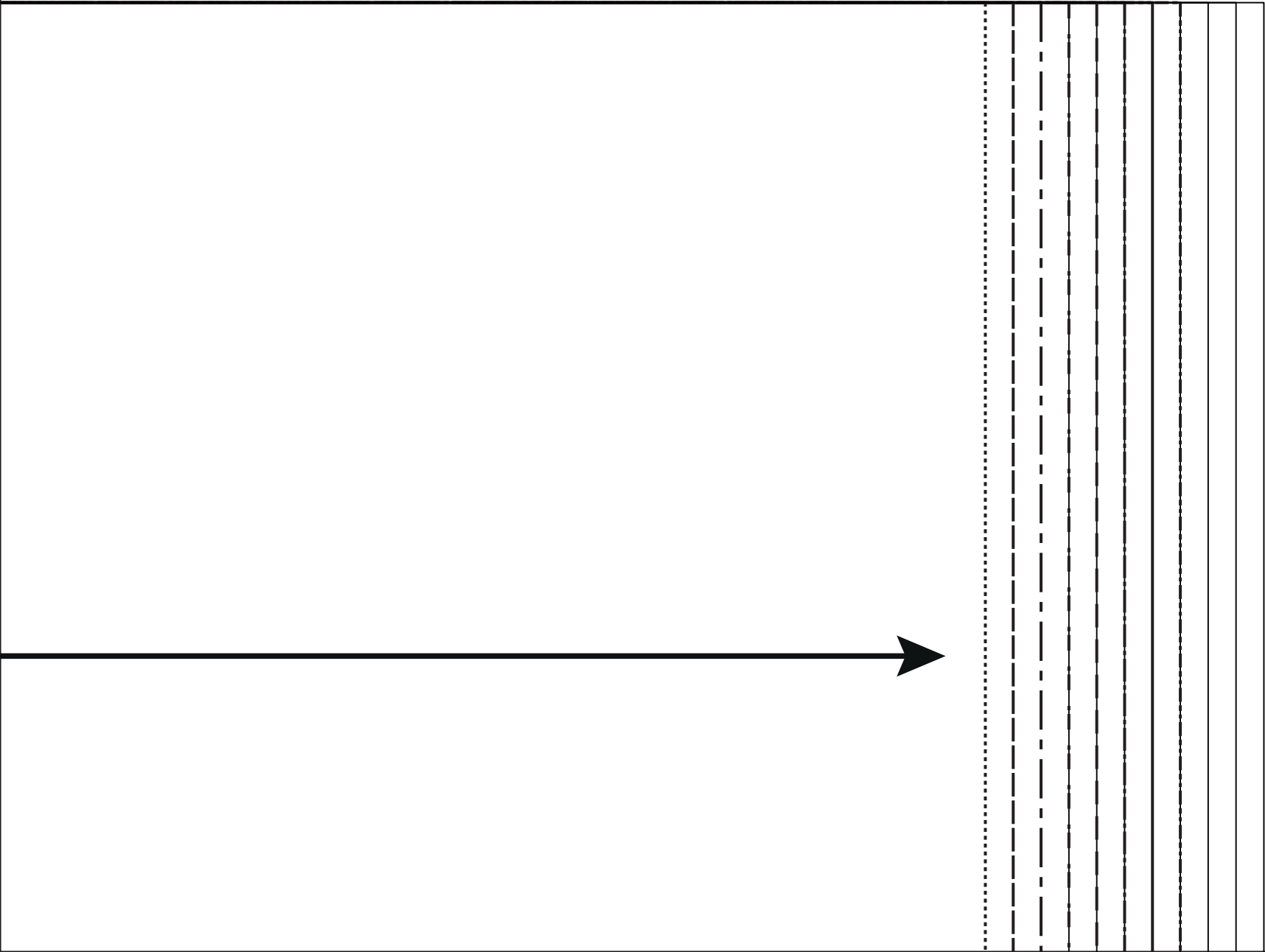

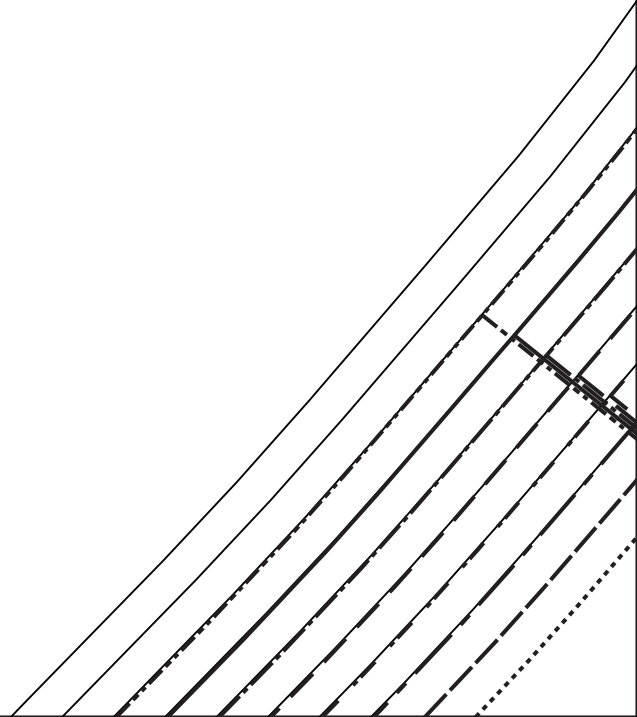
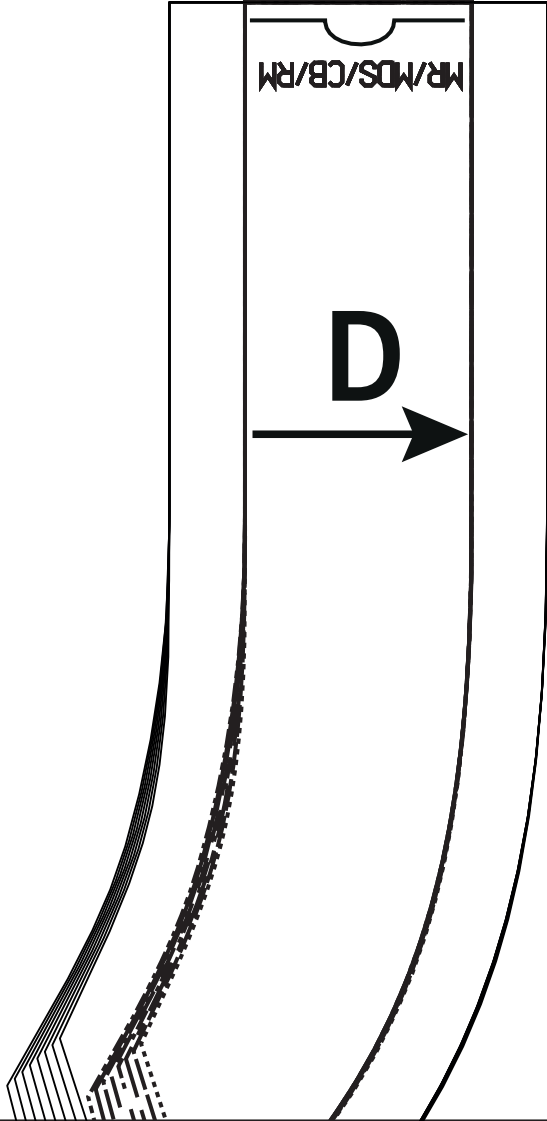

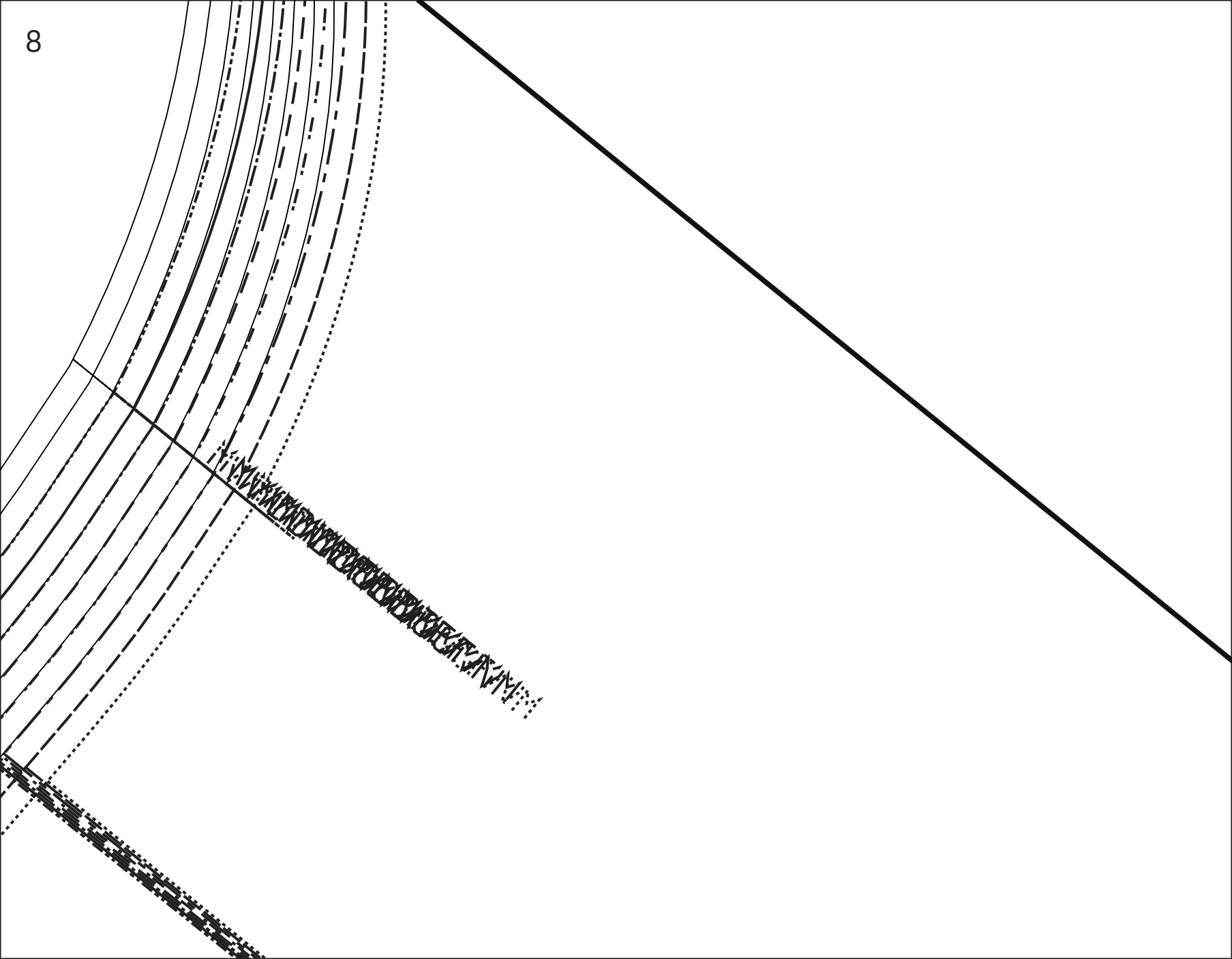



**A**

