

# Vera

## Blazer

### Maten / Tailles / Sizes / Größen:

-----	34
-----	36
-----	38
-----	40
-----	42
-----	44
-----	46
-----	48
-----	50
-----	52
-----	54
-----	56

### Patroondelen / Pièces du patron / Pattern pieces / Schnittteile:

- A** voorpand / devant / front panel / Vorderteil
- B** rugpand / dos / back panel / Rückenteil
- C** kraag / col / collar / Kragen
- D/D'** bovenmouw / dessus de manche / sleeve top / oberer Ärmel
- E/E'** ondermouw / sleeve bottom / dessous de manche / onderer Ärmel
- F** beleg VP / parementure DV / facing FP / Besatz VT
- G** beleg RP / parementure DS / facing BP / Besatz RT
- H** zak / poche / pocket / Tasche

### Patroonschema / Schéma du Patron / Pattern Diagram / Übersichtsplan zum Zusammenkleben

1	2	3	4	5	6
7	8	9	10	11	12
13	14	15	16	17	18
19	20	21	22	23	24
25	26	27	28	29	30
31	32	33	34	35	36

### Controlevierkant / Carré de controle / Test square / Kontrollquadrat

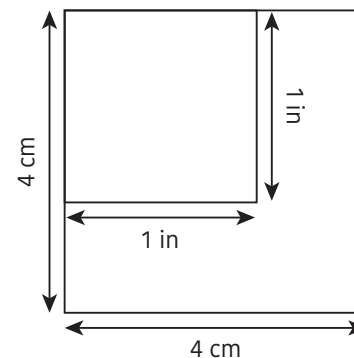

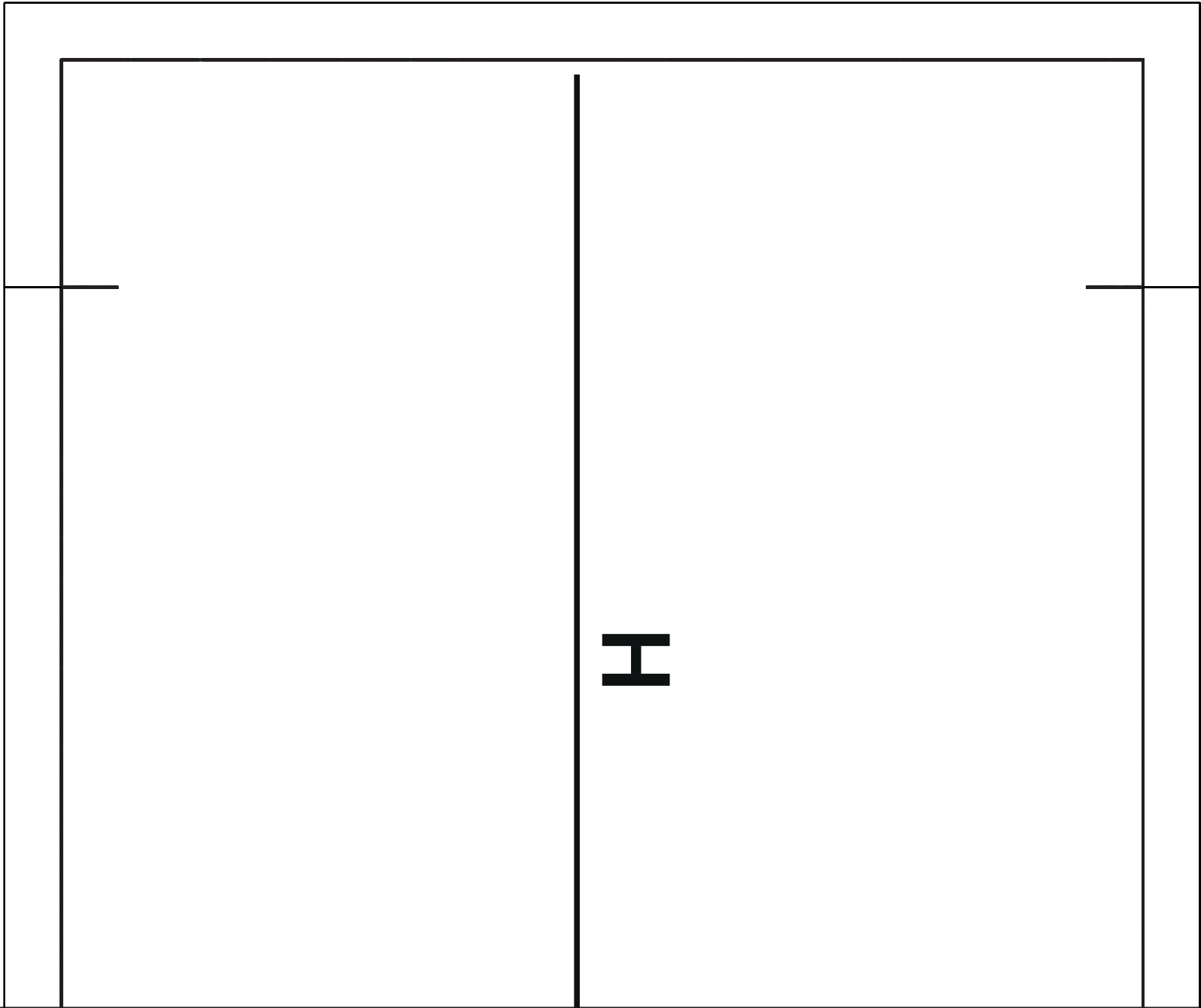

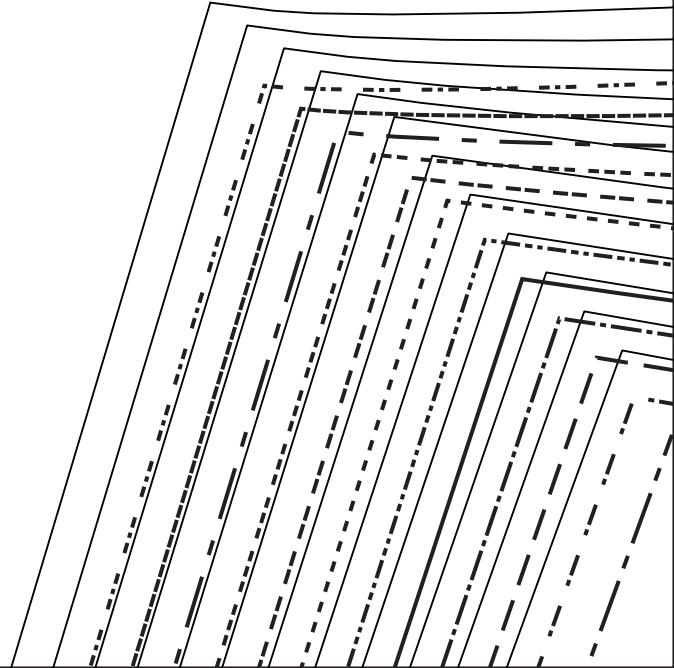
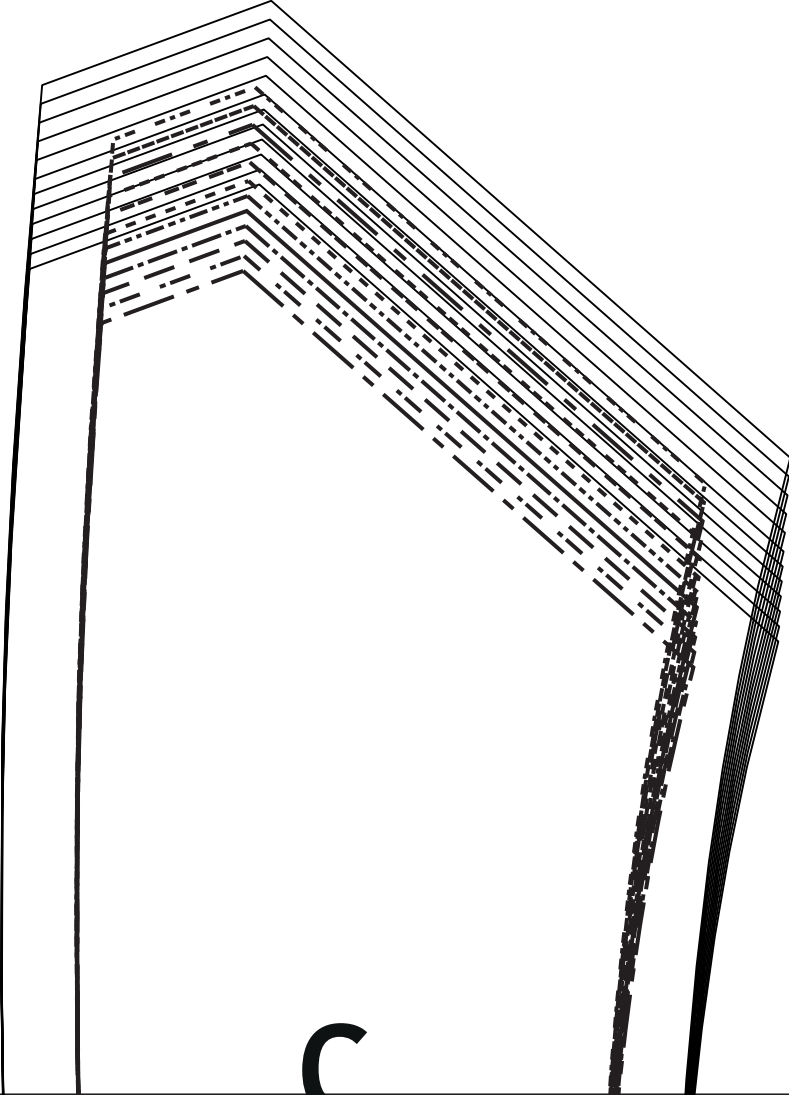

C

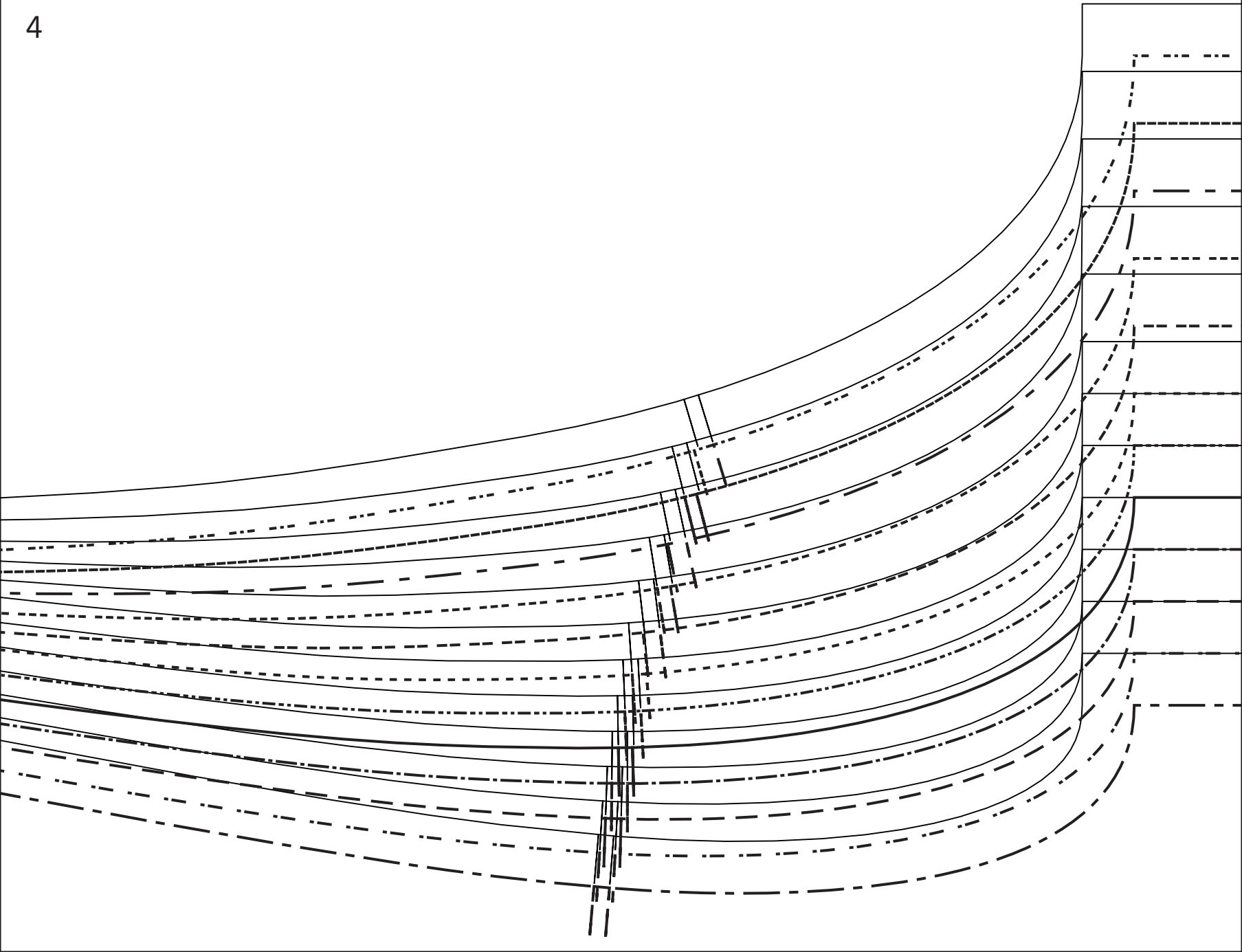





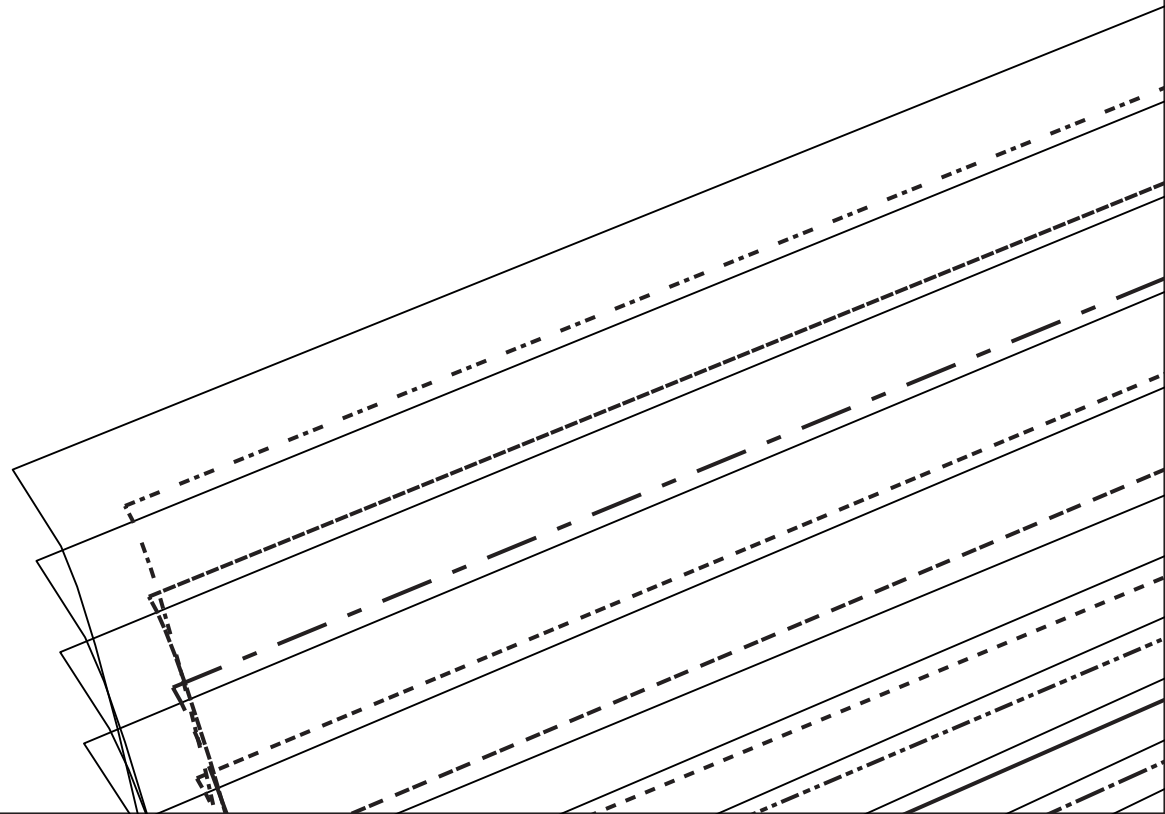

8

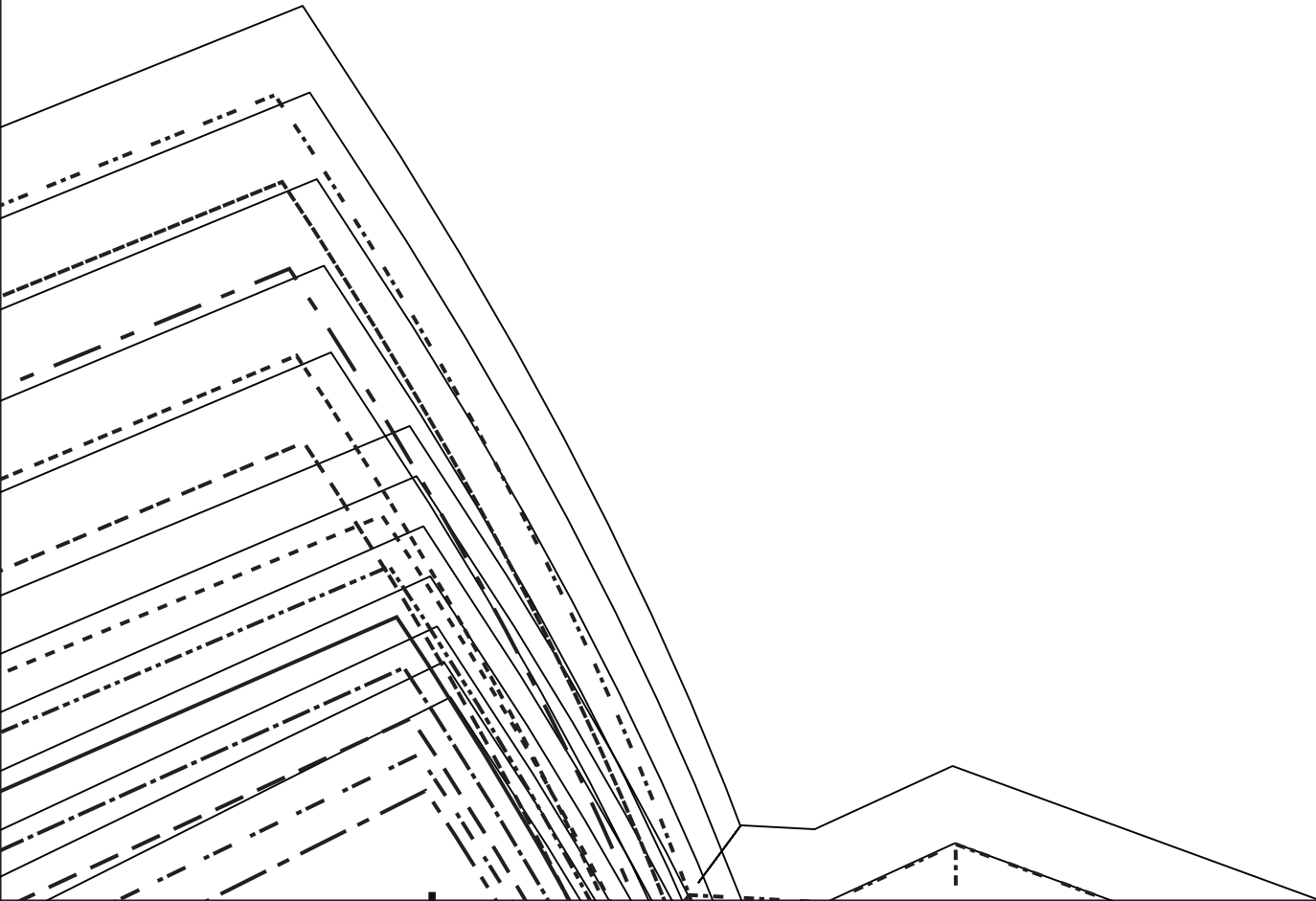
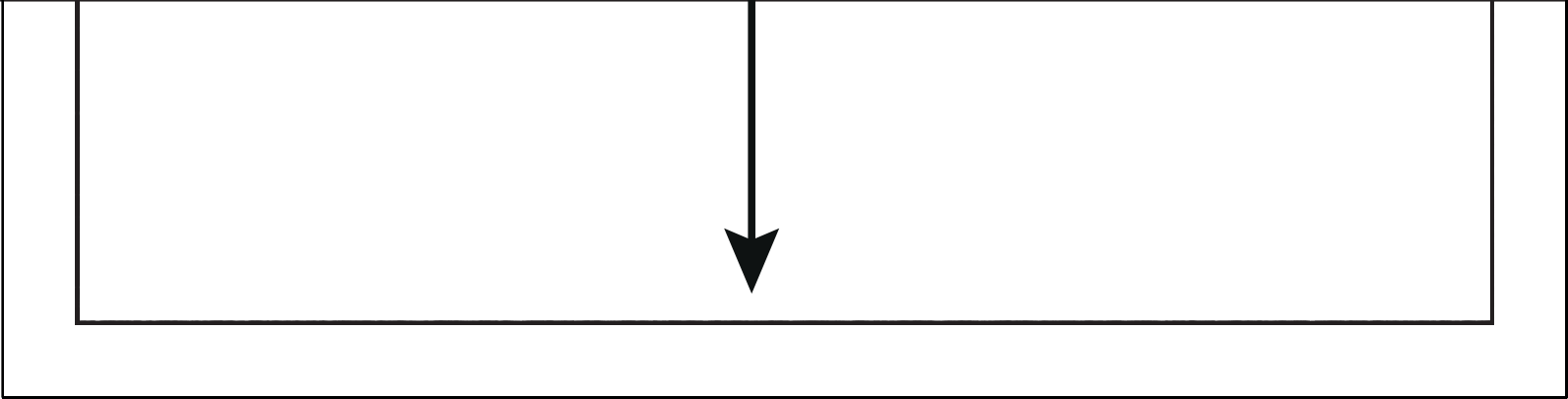



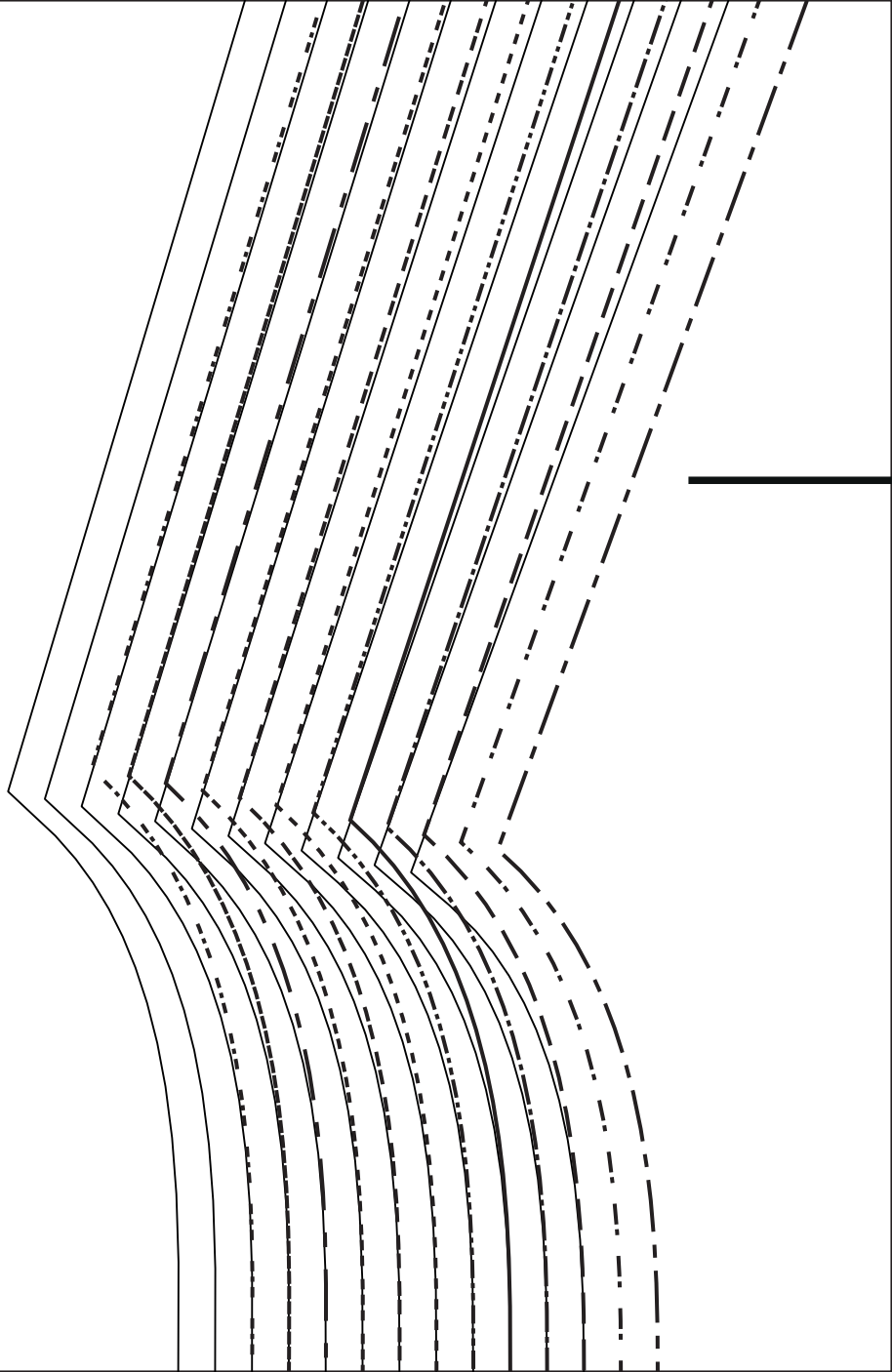
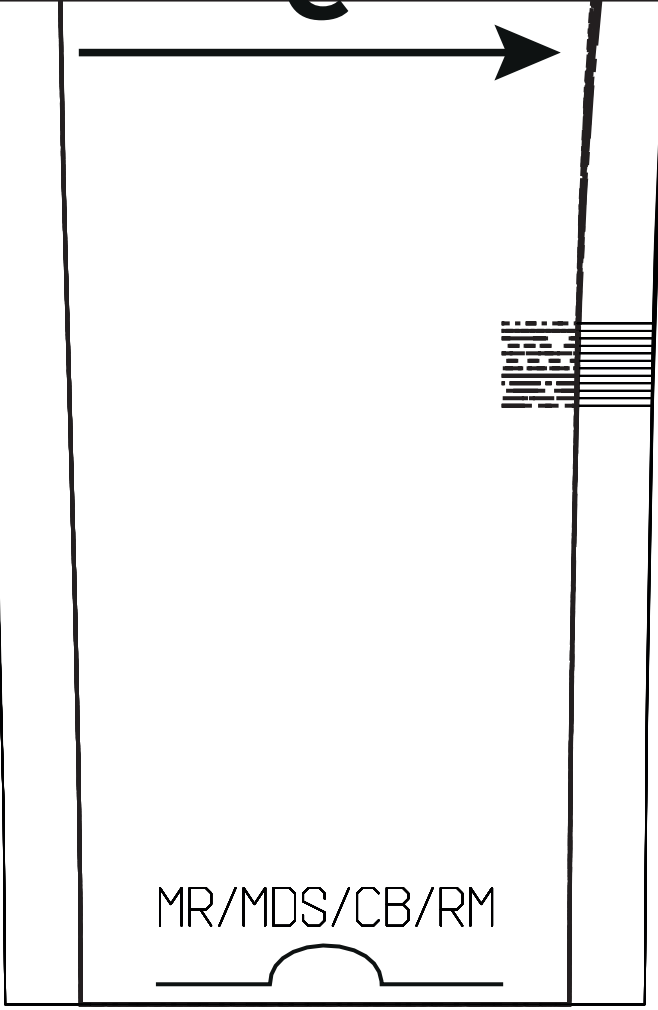



**B**





--	--	--	--	--	--

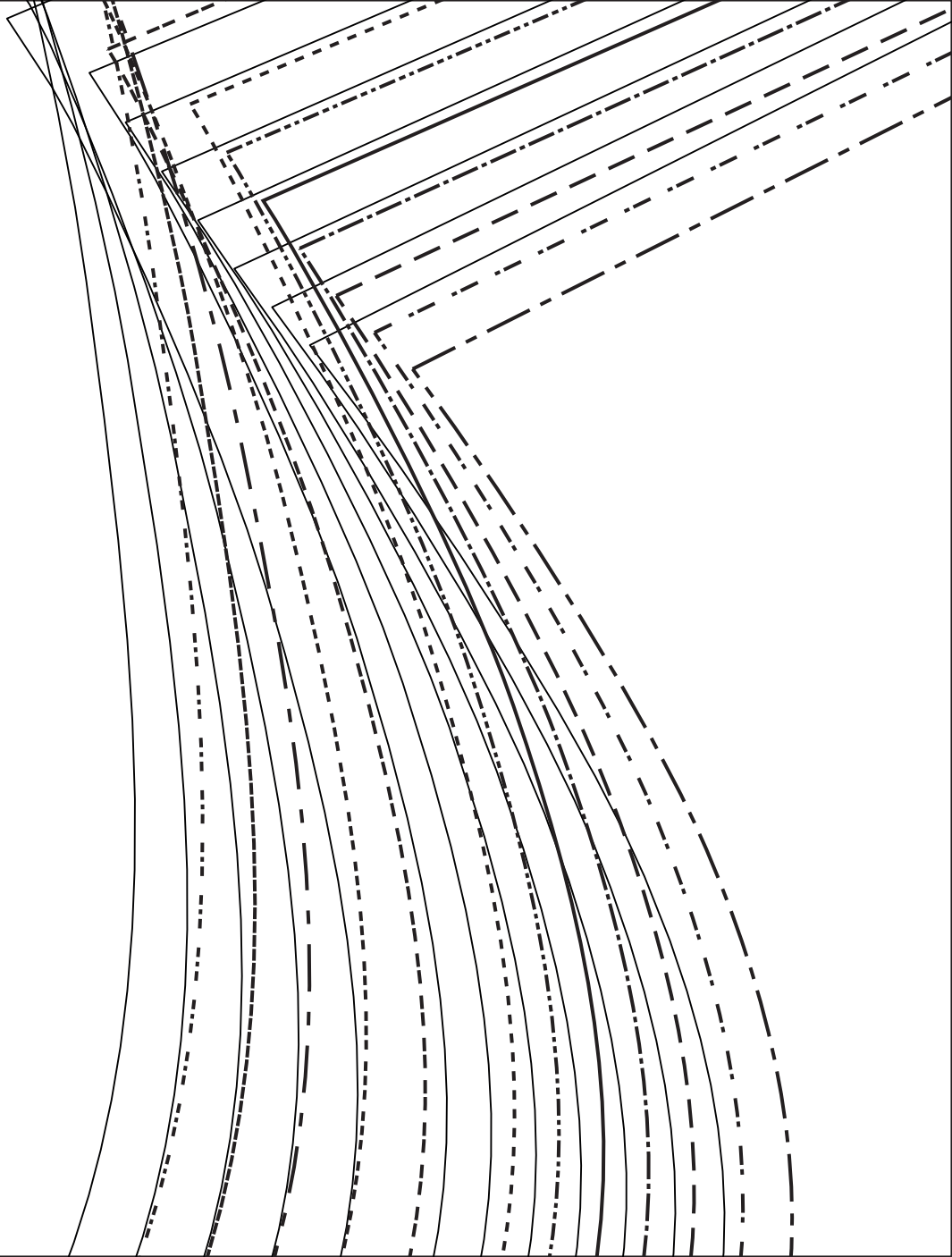

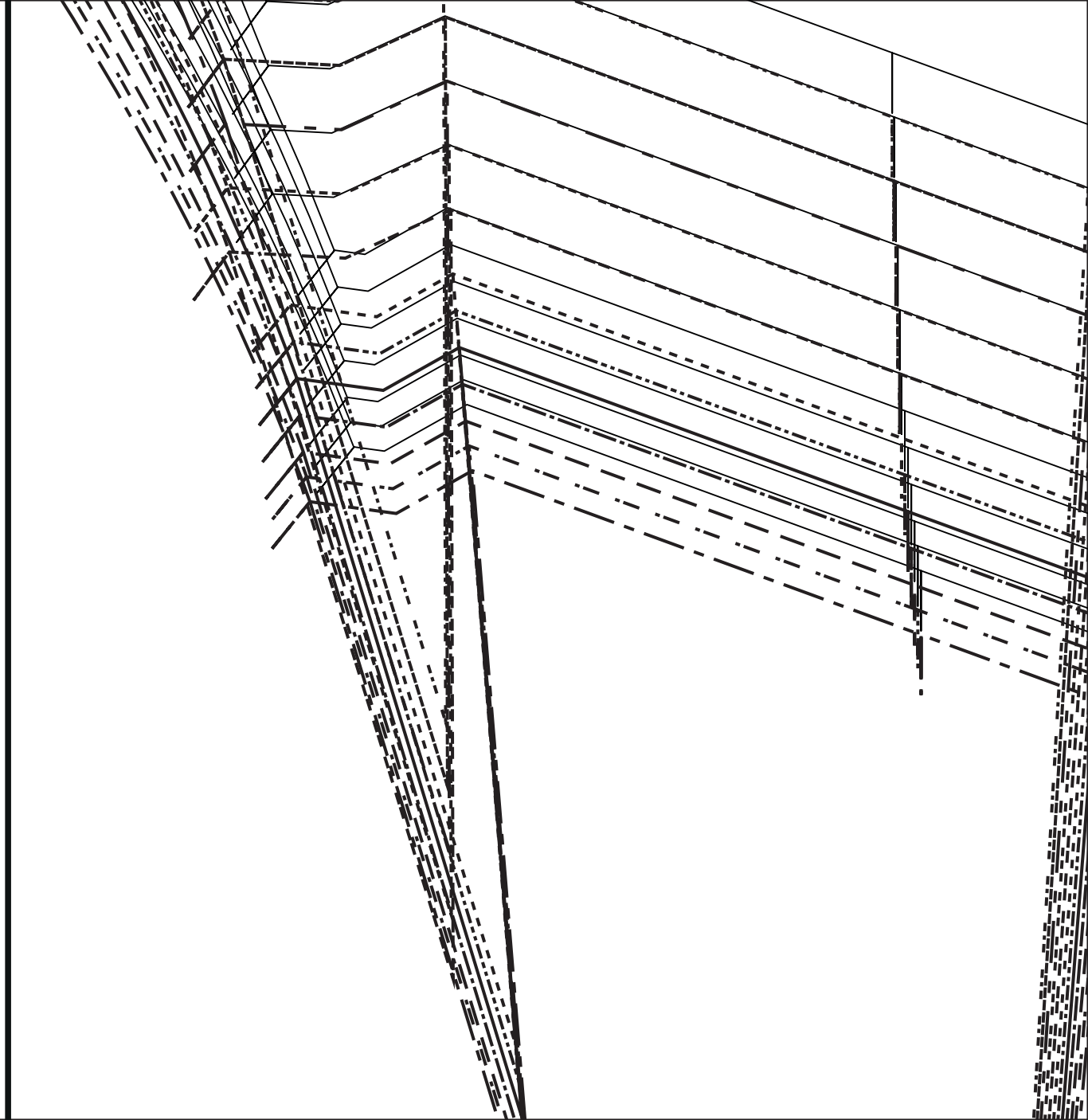

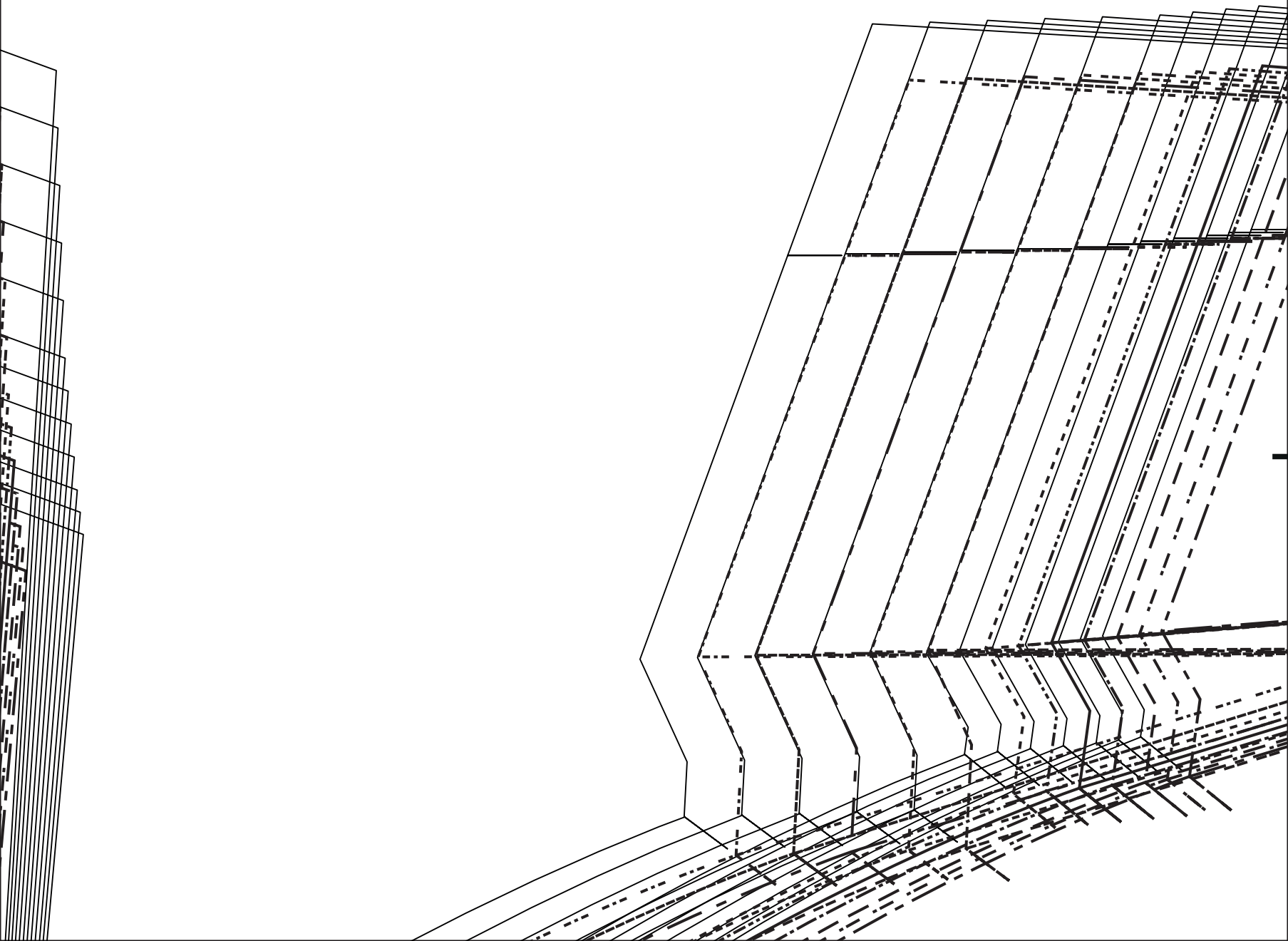

16

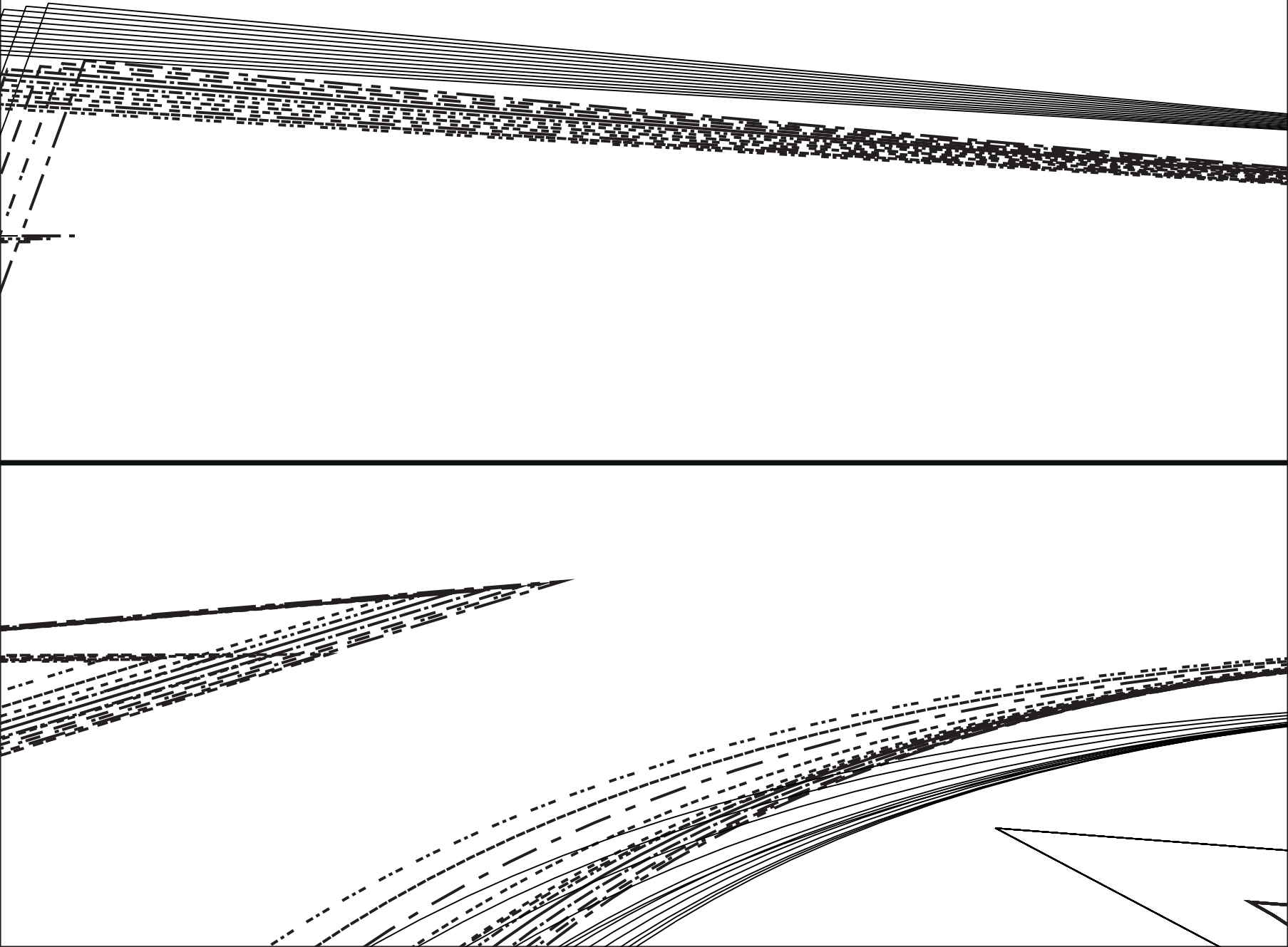



**F**



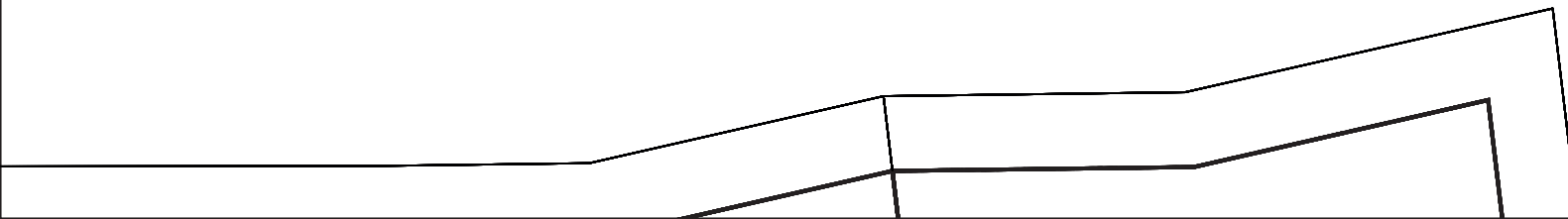
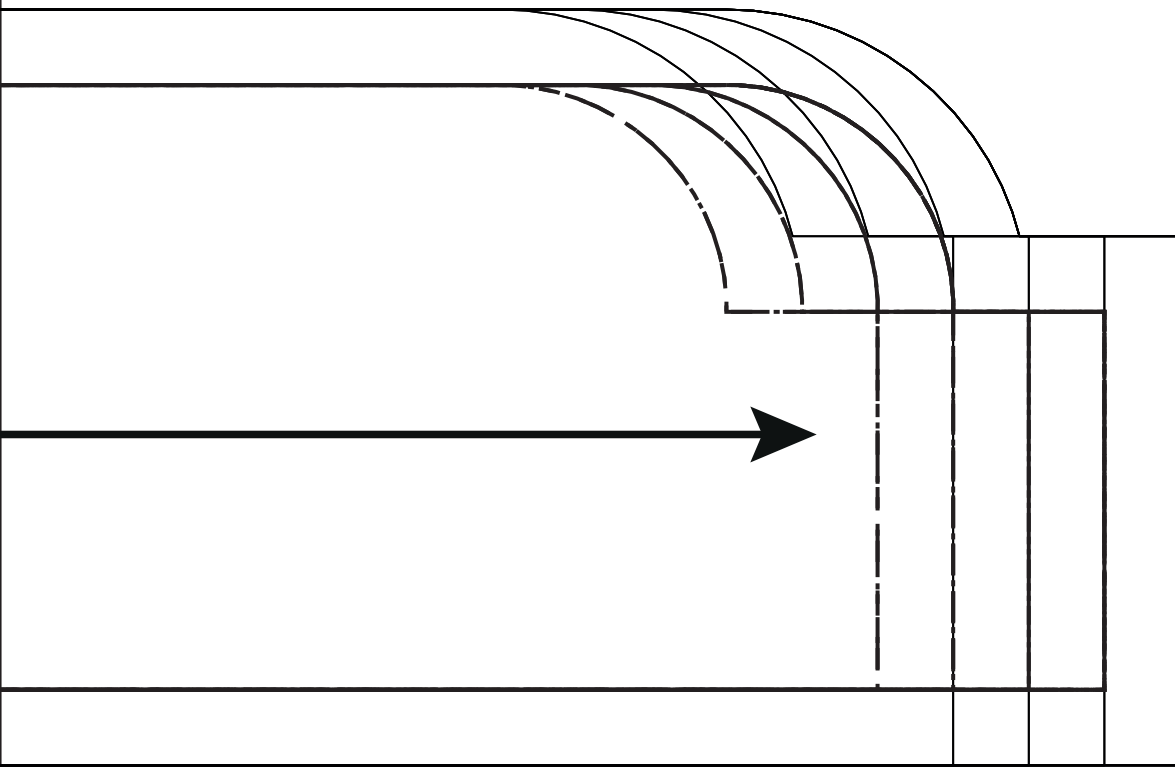

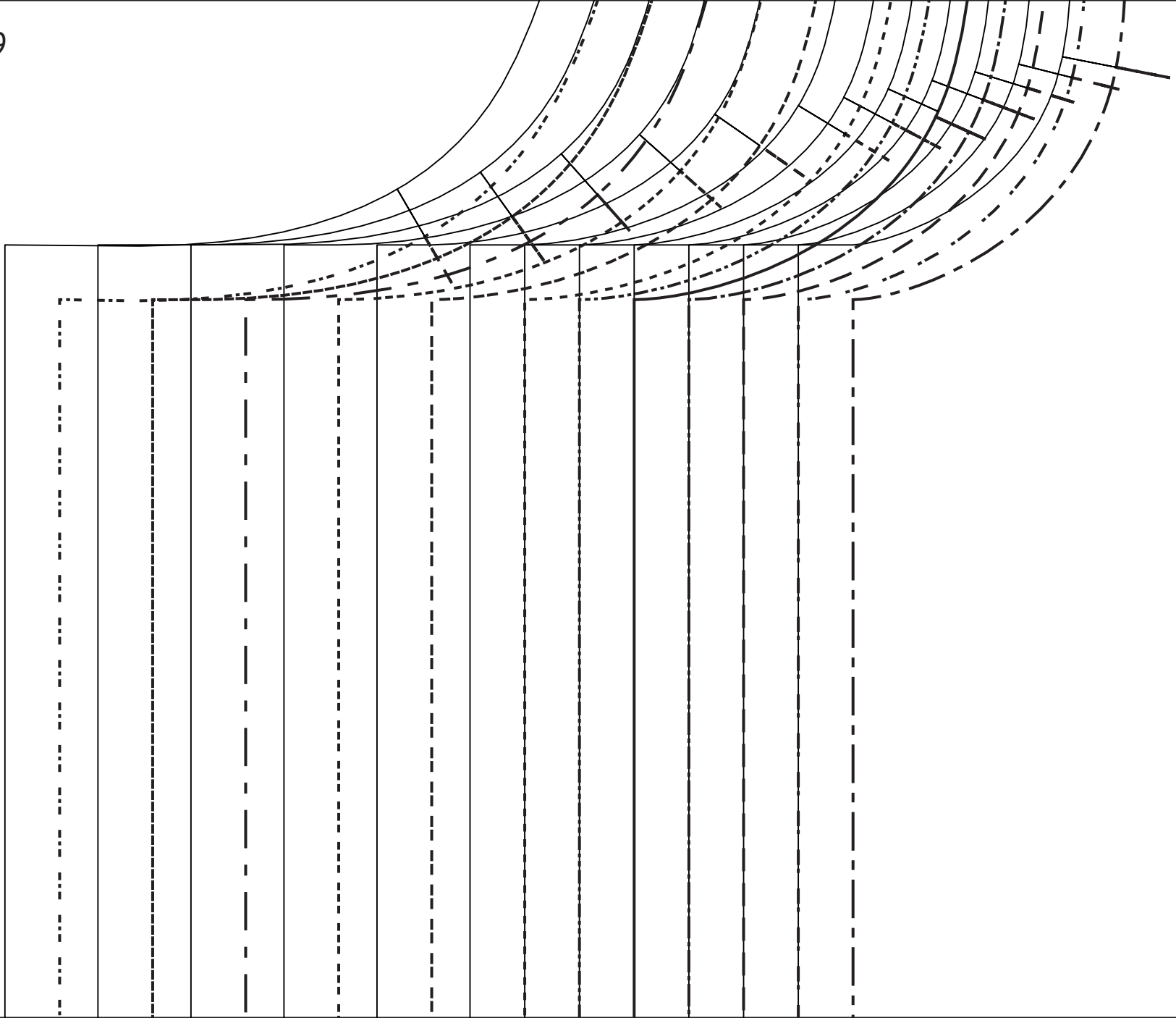

**A**



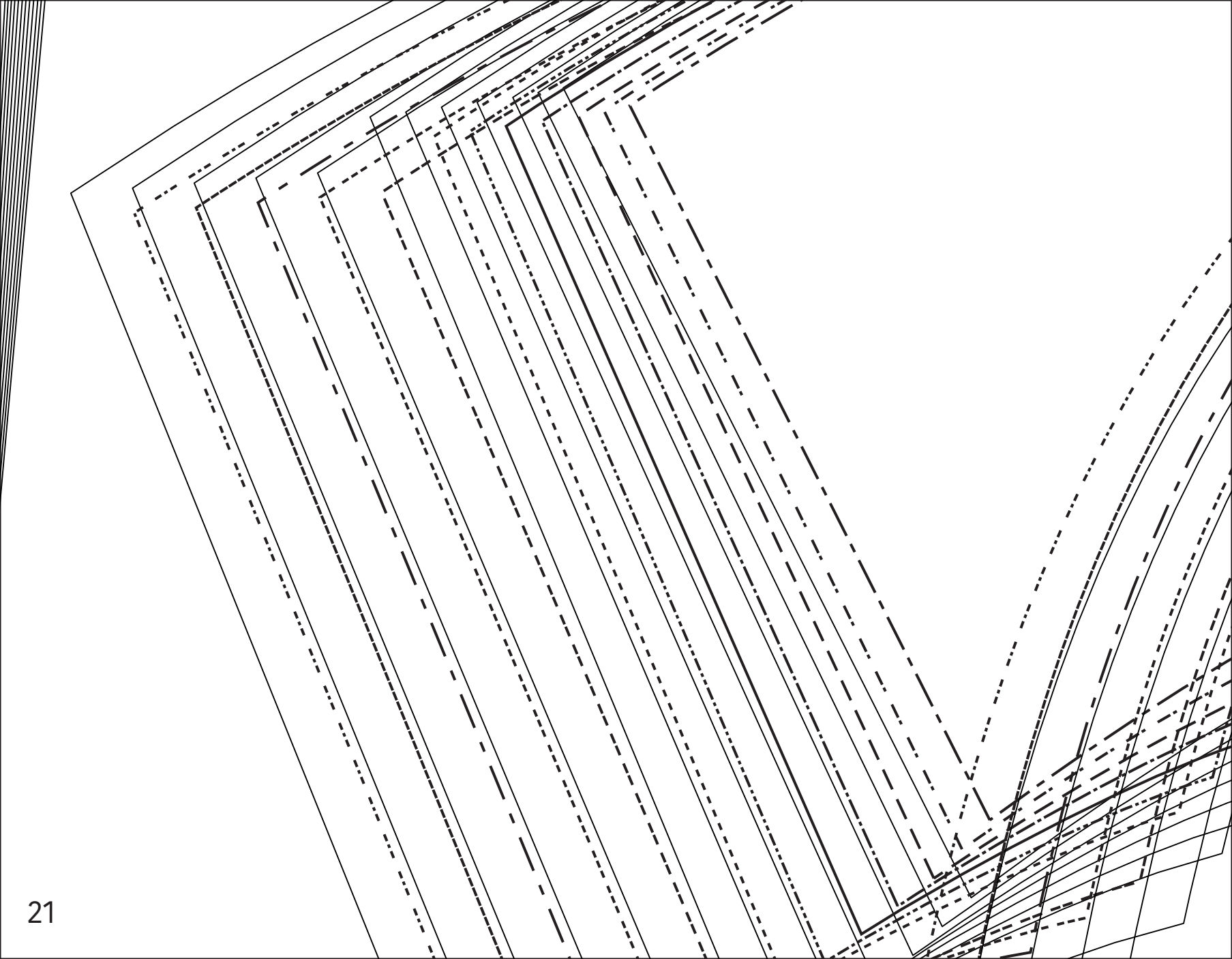

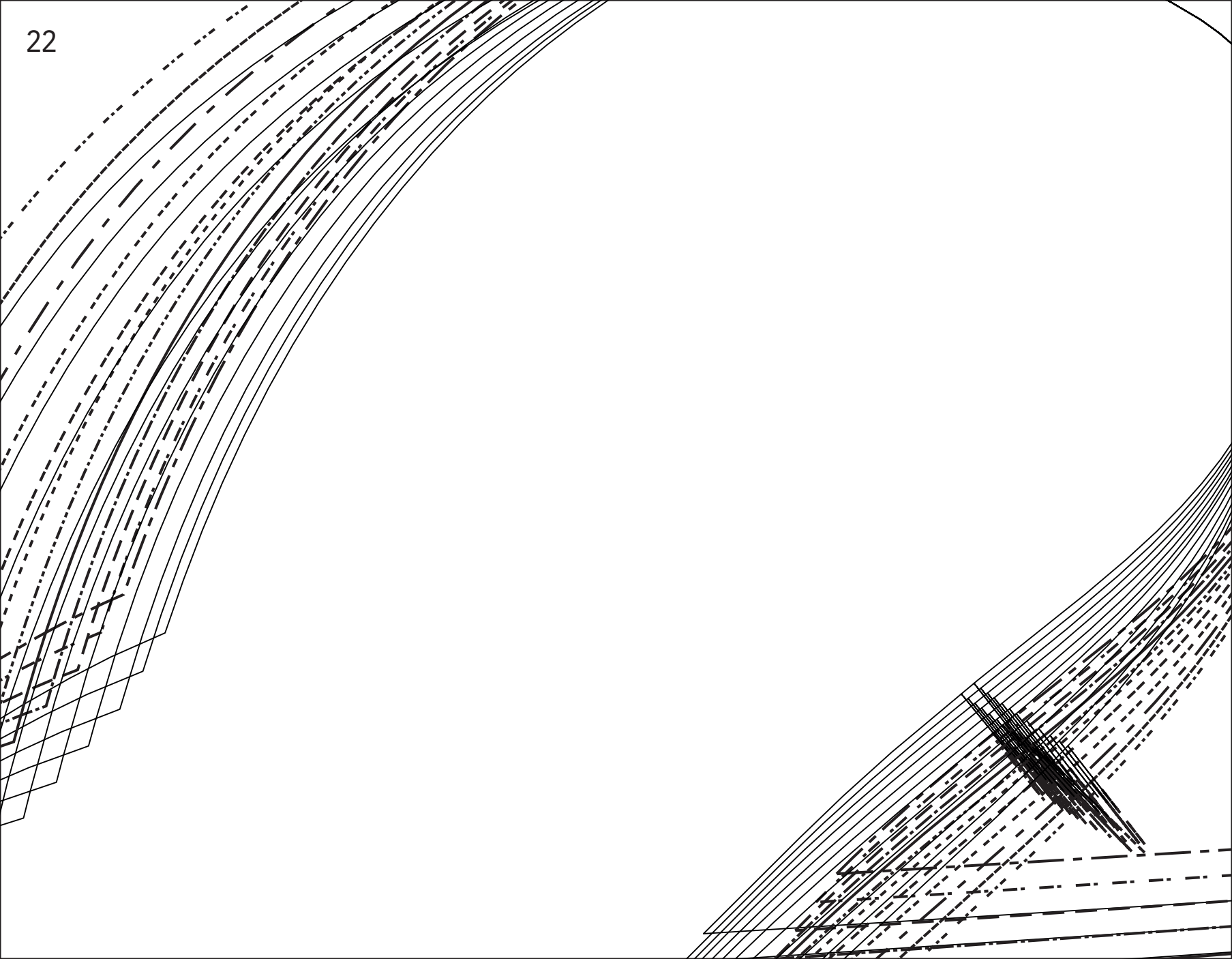

23

**E/E'**

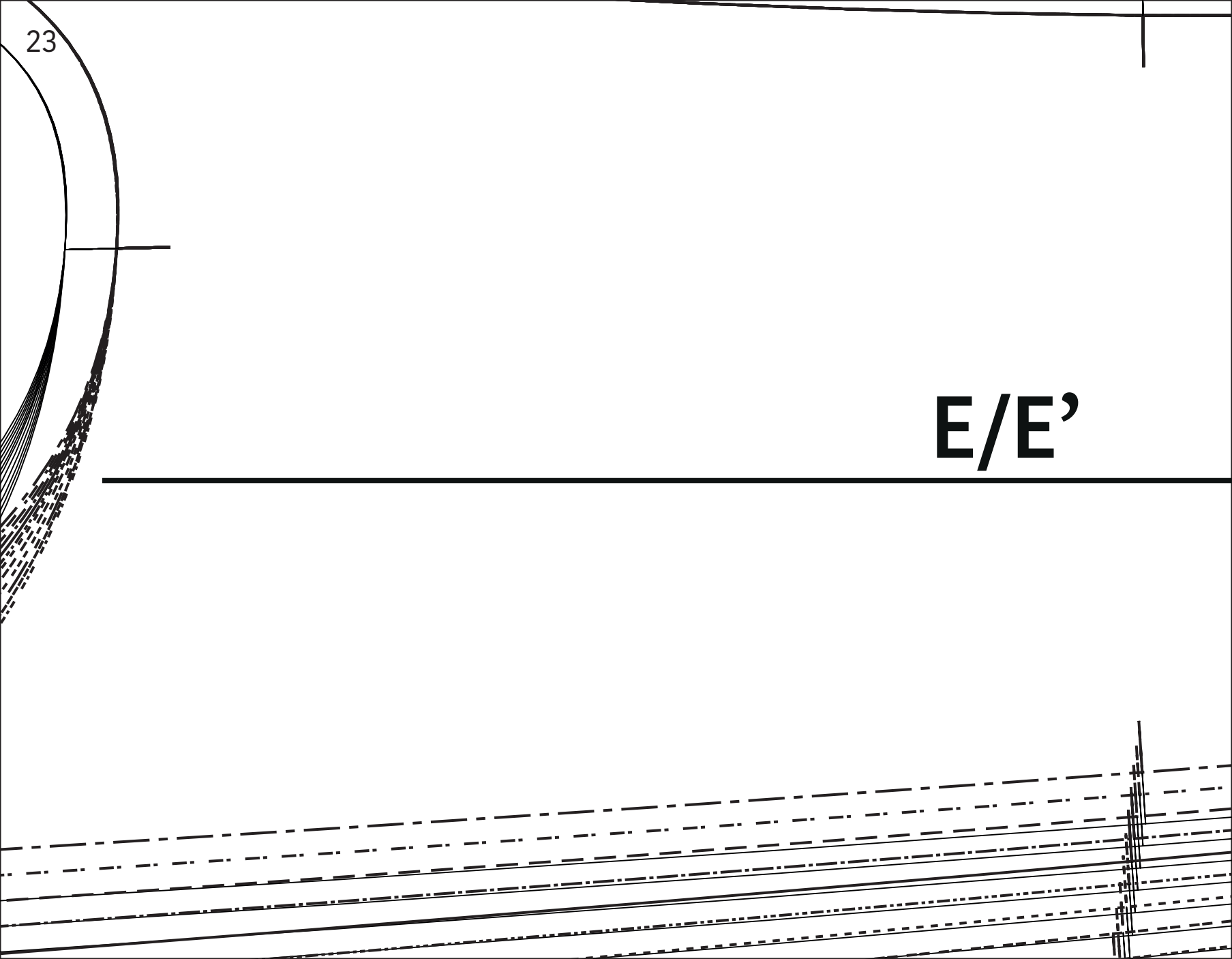

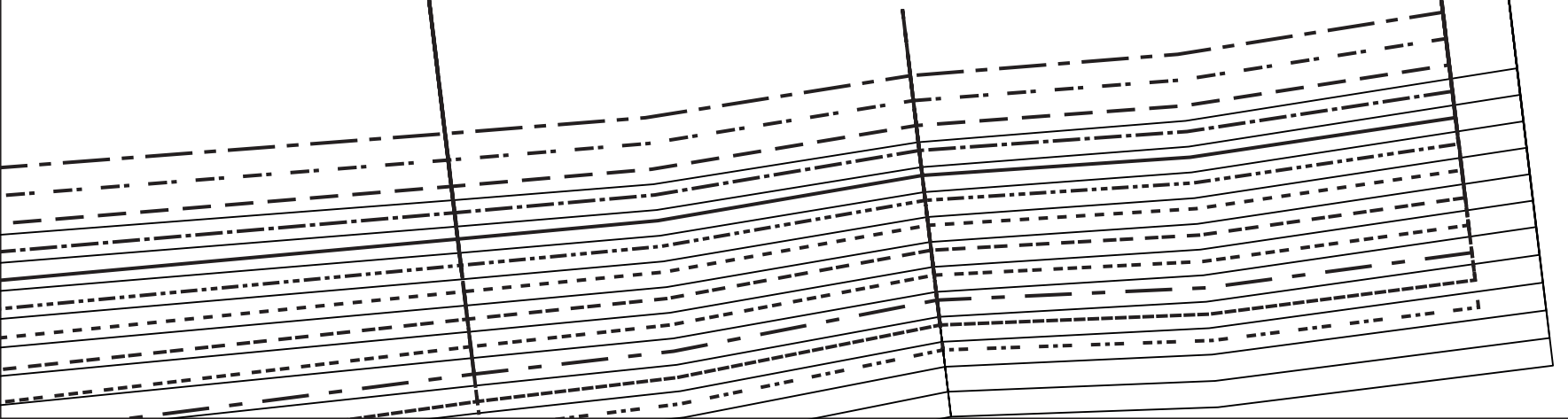
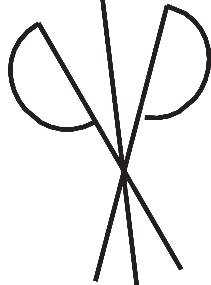







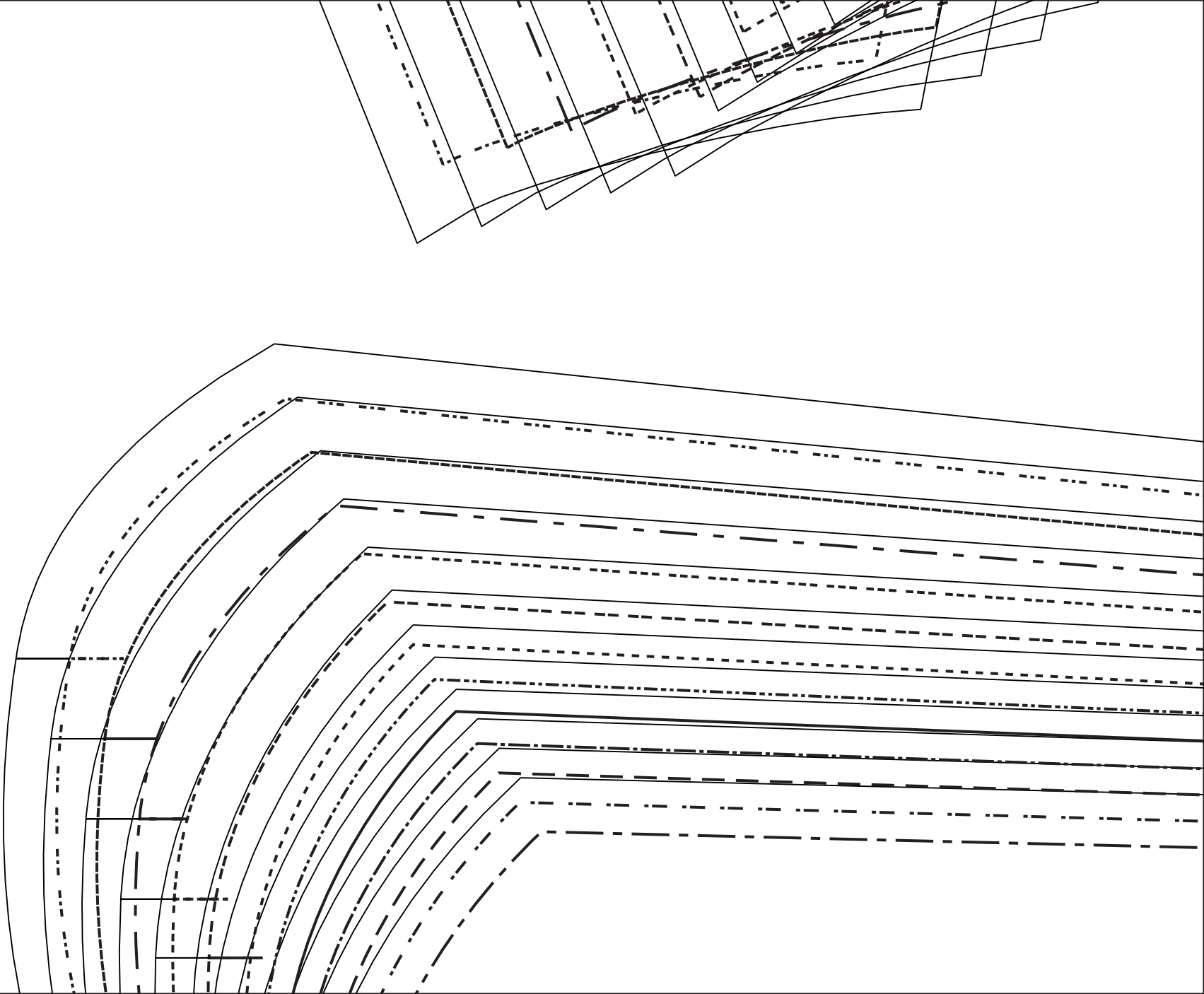

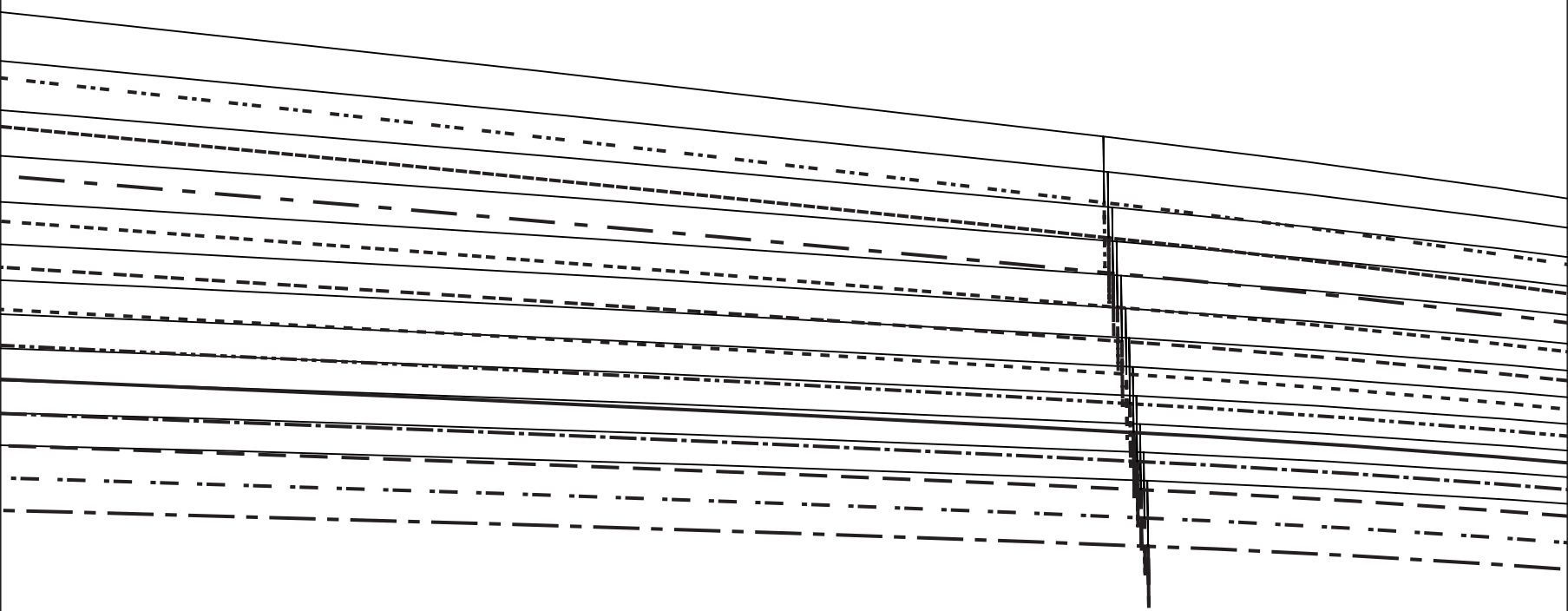
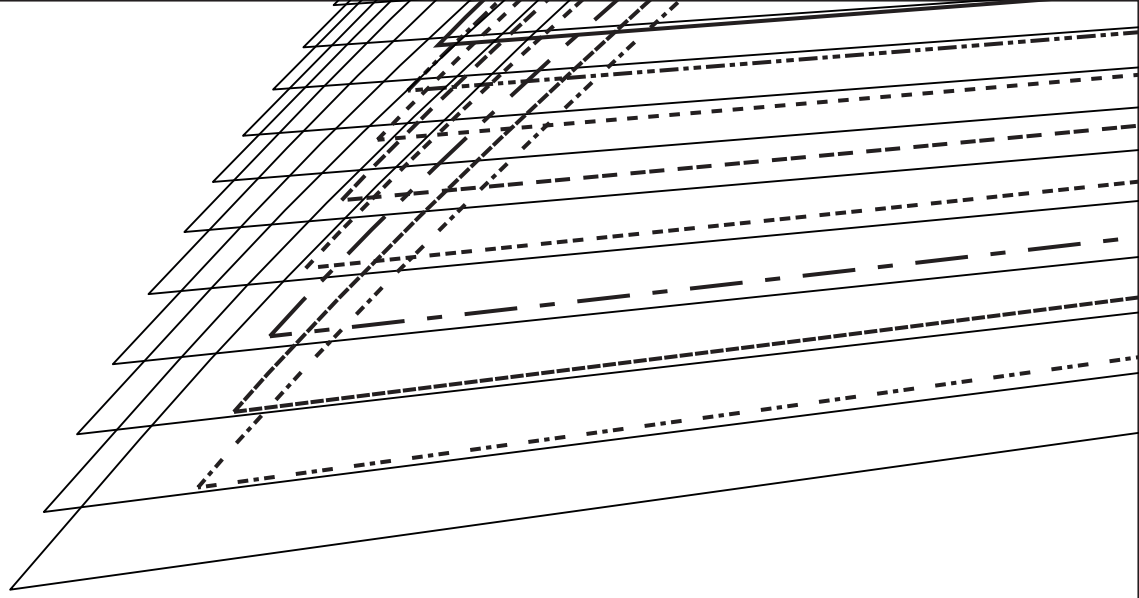

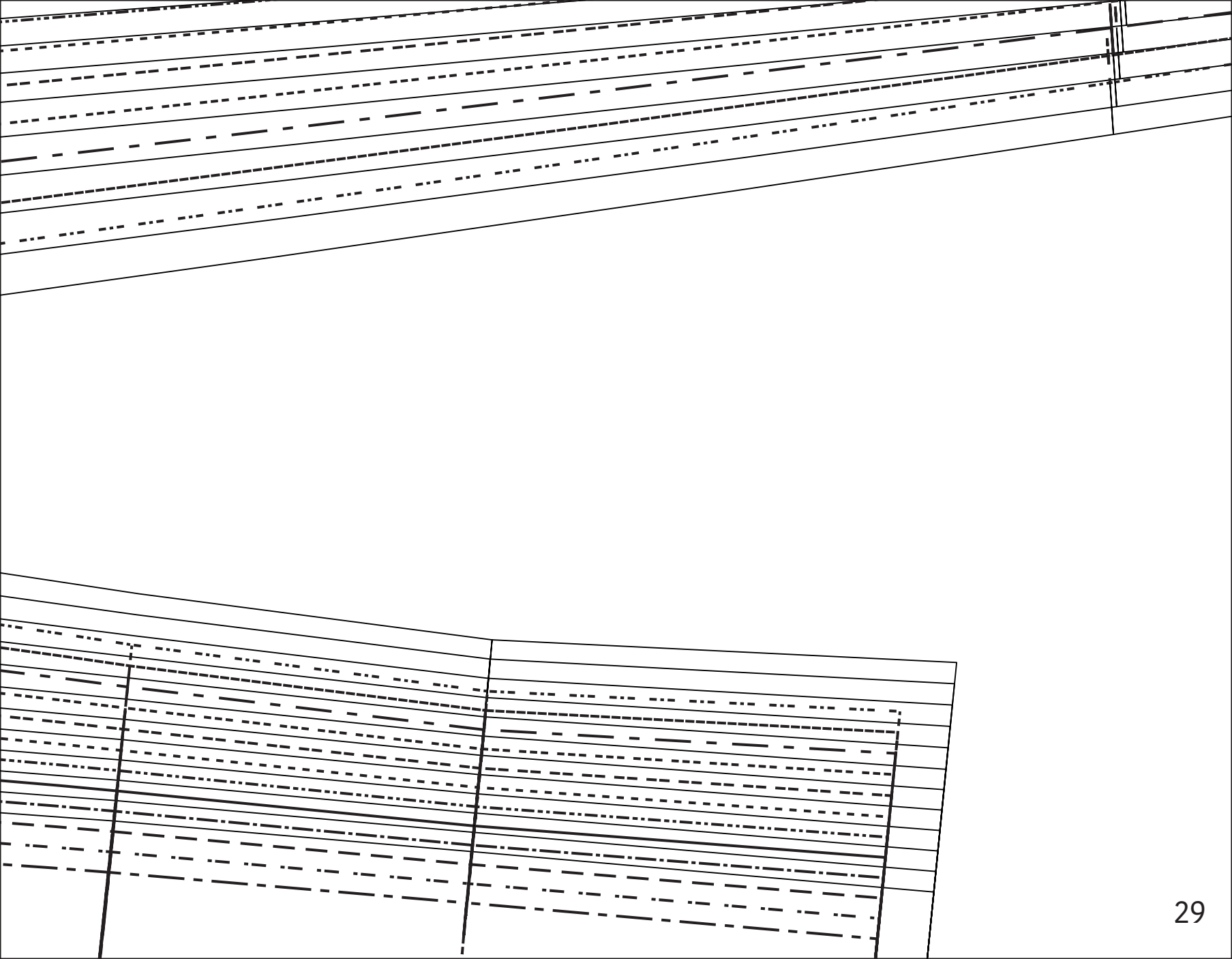

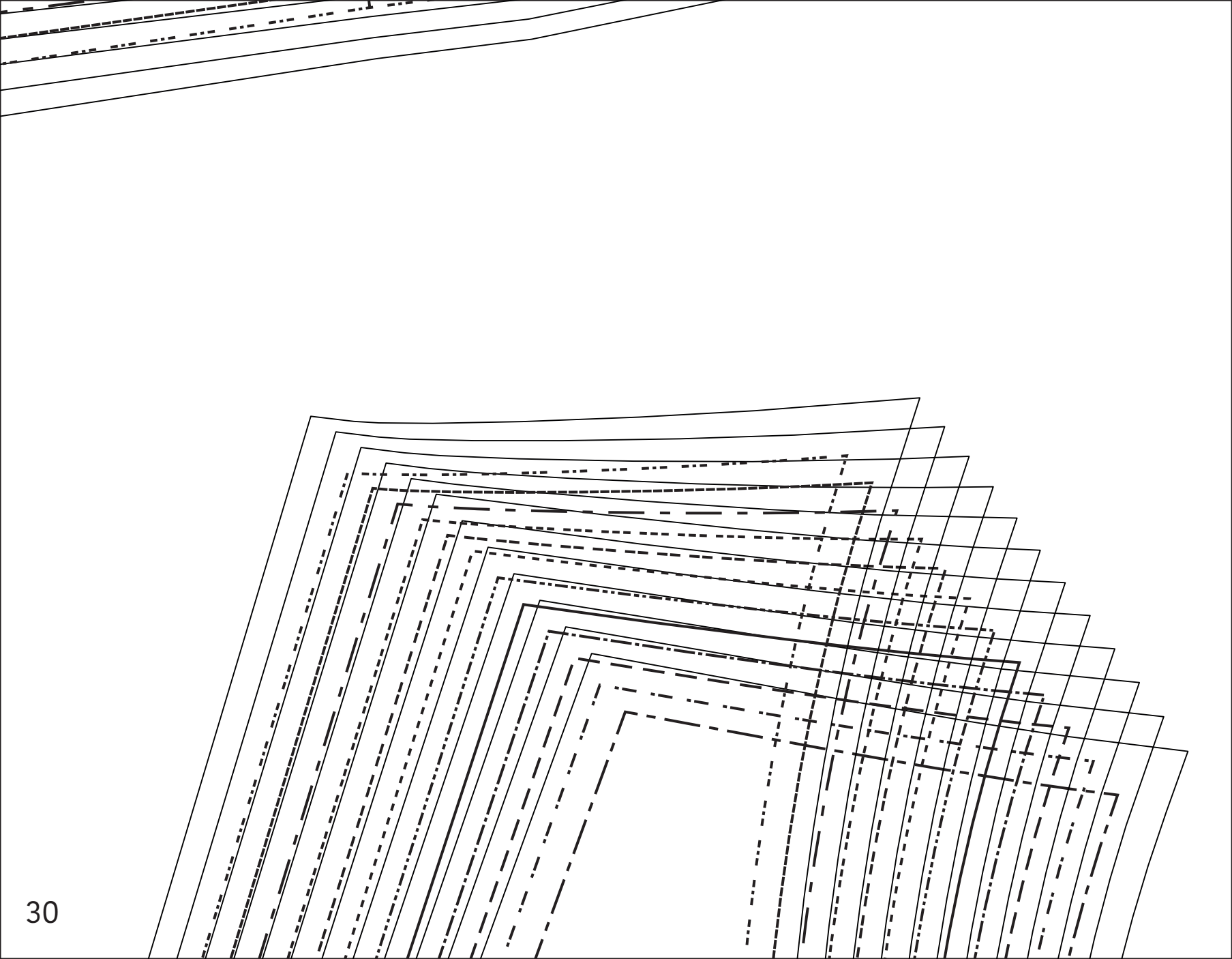



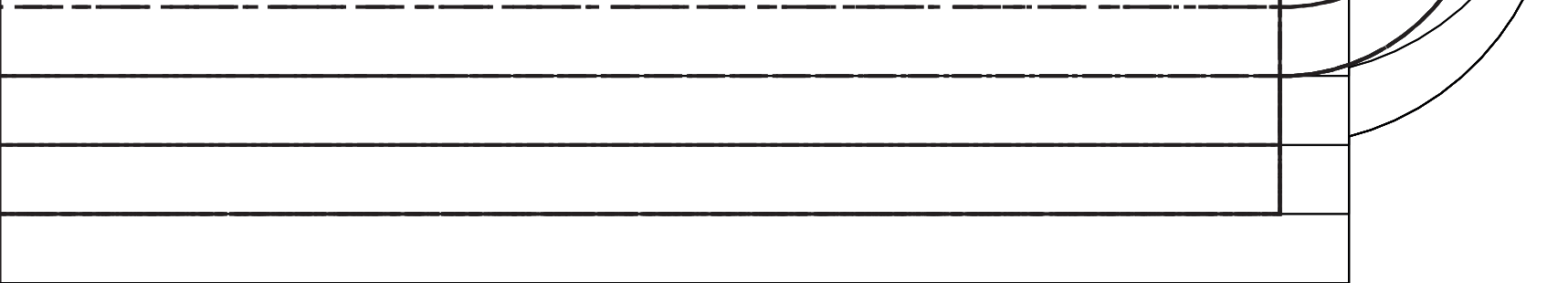



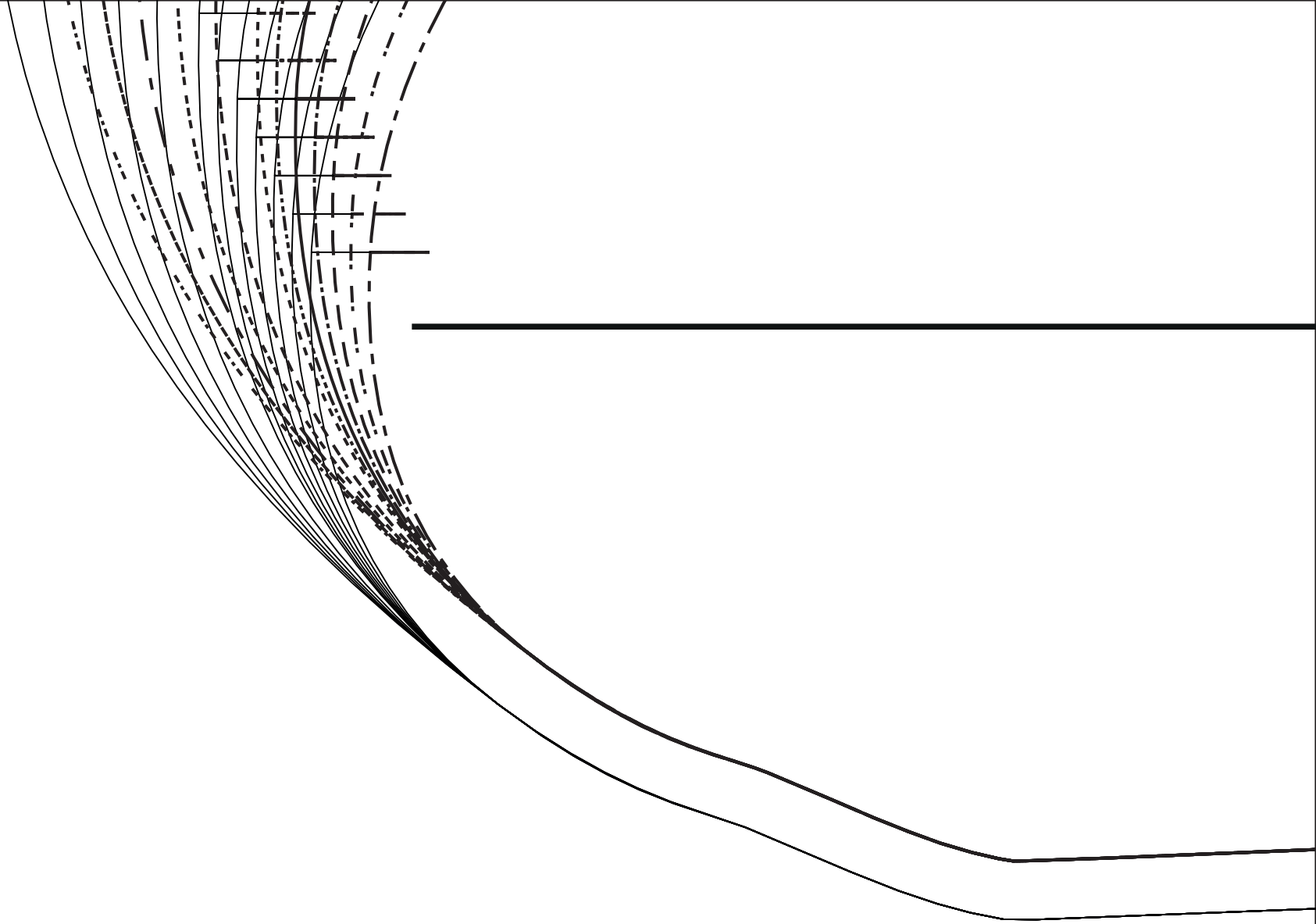

$D/D'$ 