

Jaxon

Hemd / Chemise Shirt

Maten / Tailles / Sizes / Größen:

.....	XXS
-----	XS
-----	S
-----	M
-----	L
-----	XL
-----	XXL
-----	XXXL

Patroondelen / Pièces du patron / Pattern pieces / Schnittteile:

- A** voorpand / devant / front panel /
Vorderteil
- B** rugpand / dos / back panel /
Rückenteil
- C** mouw / manche / sleeve / Ärmel
- D** kraag / col / collar / Kragen

Patroonschema / Schéma du Patron / Pattern Diagram / Übersichtsplan zum Zusammenkleben

1	2	3	4	5	6
7	8	9	10	11	12
13	14	15	16	17	18
19	20	21	22	23	24

Controlevierkant / Carré de controle / Test square / Kontrollquadrat

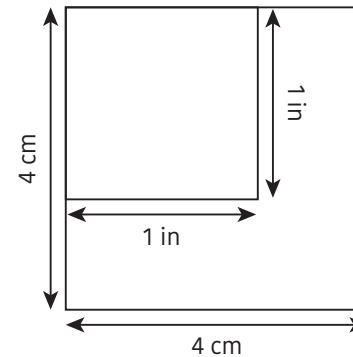

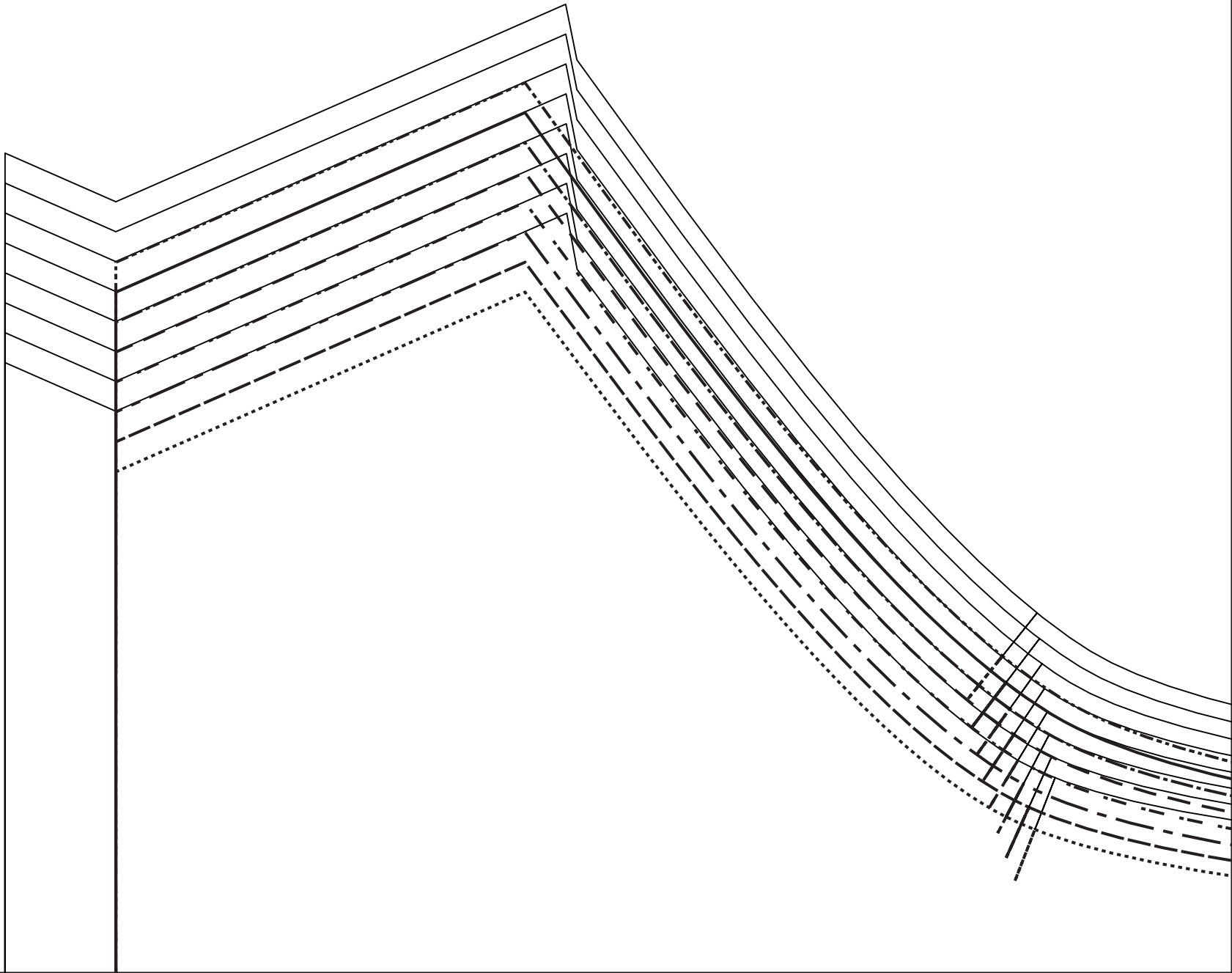

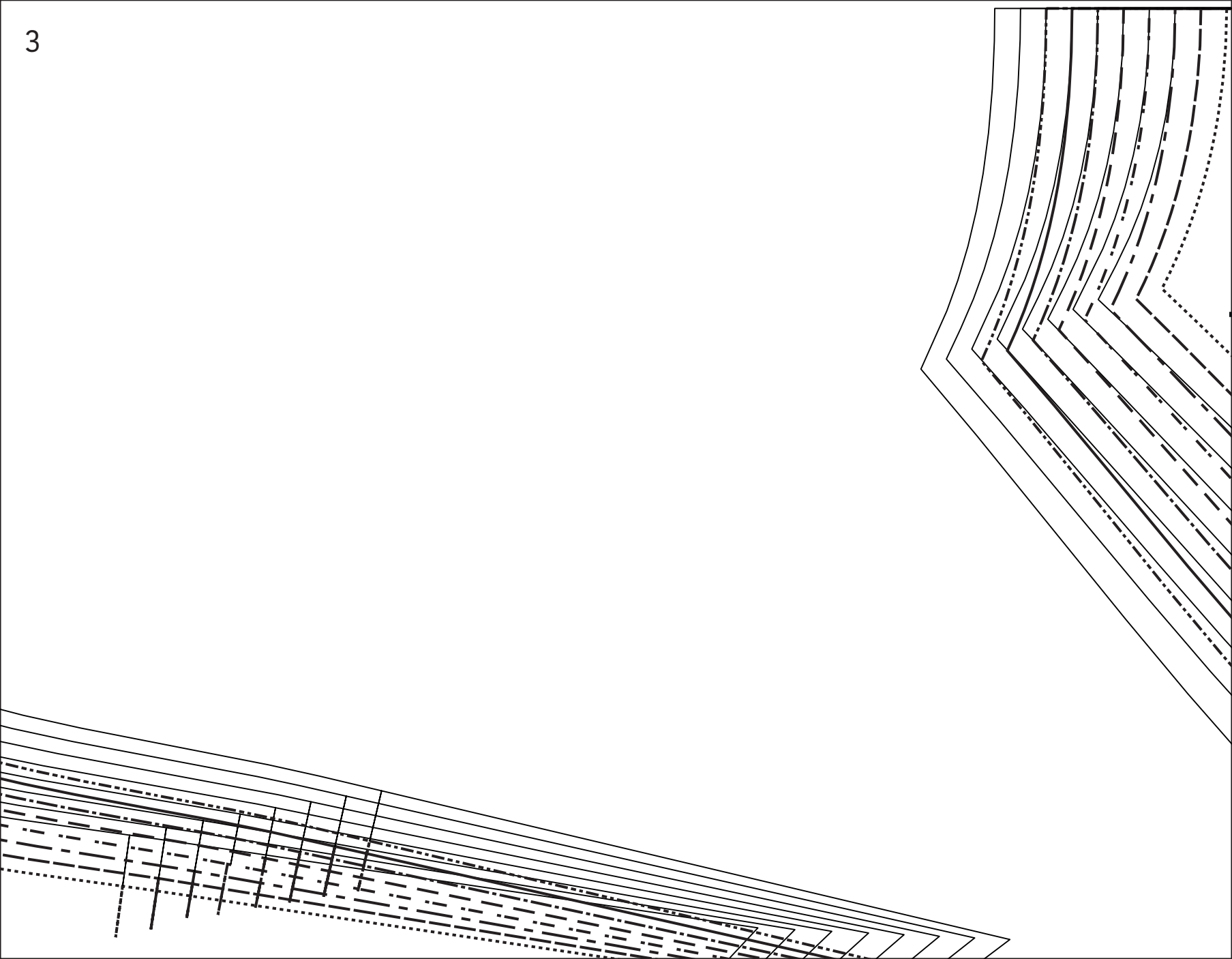

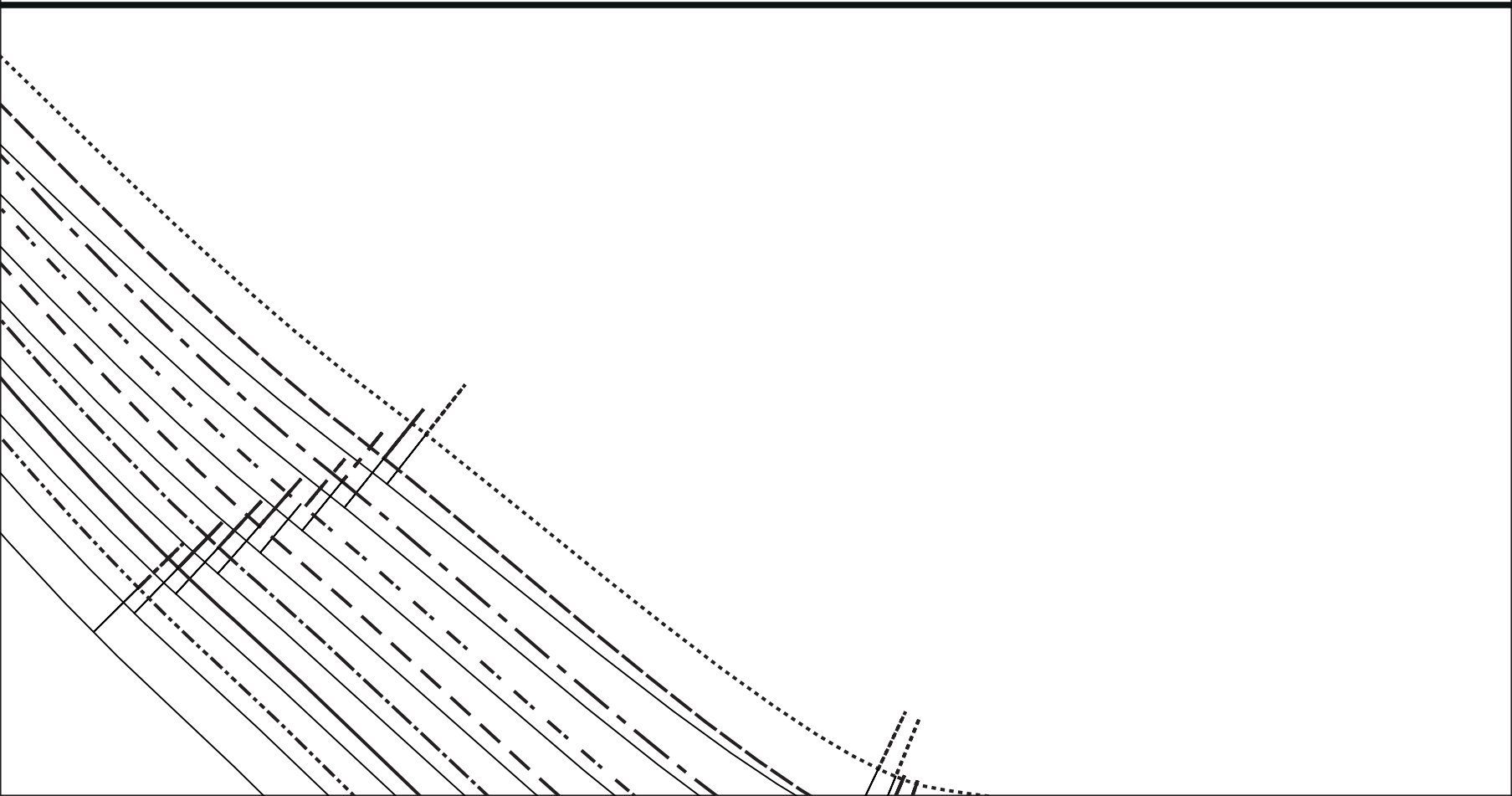

B



6



8



c



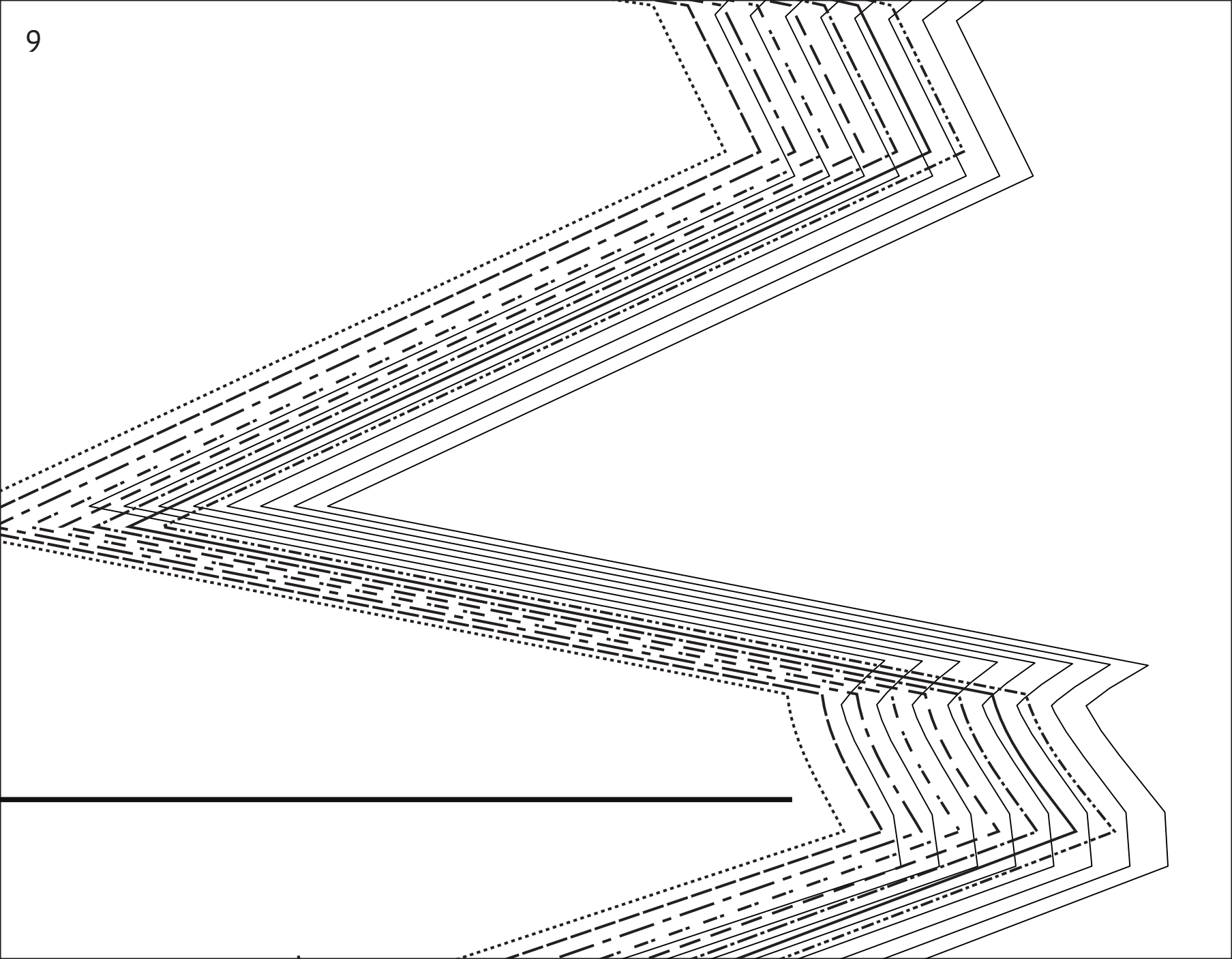

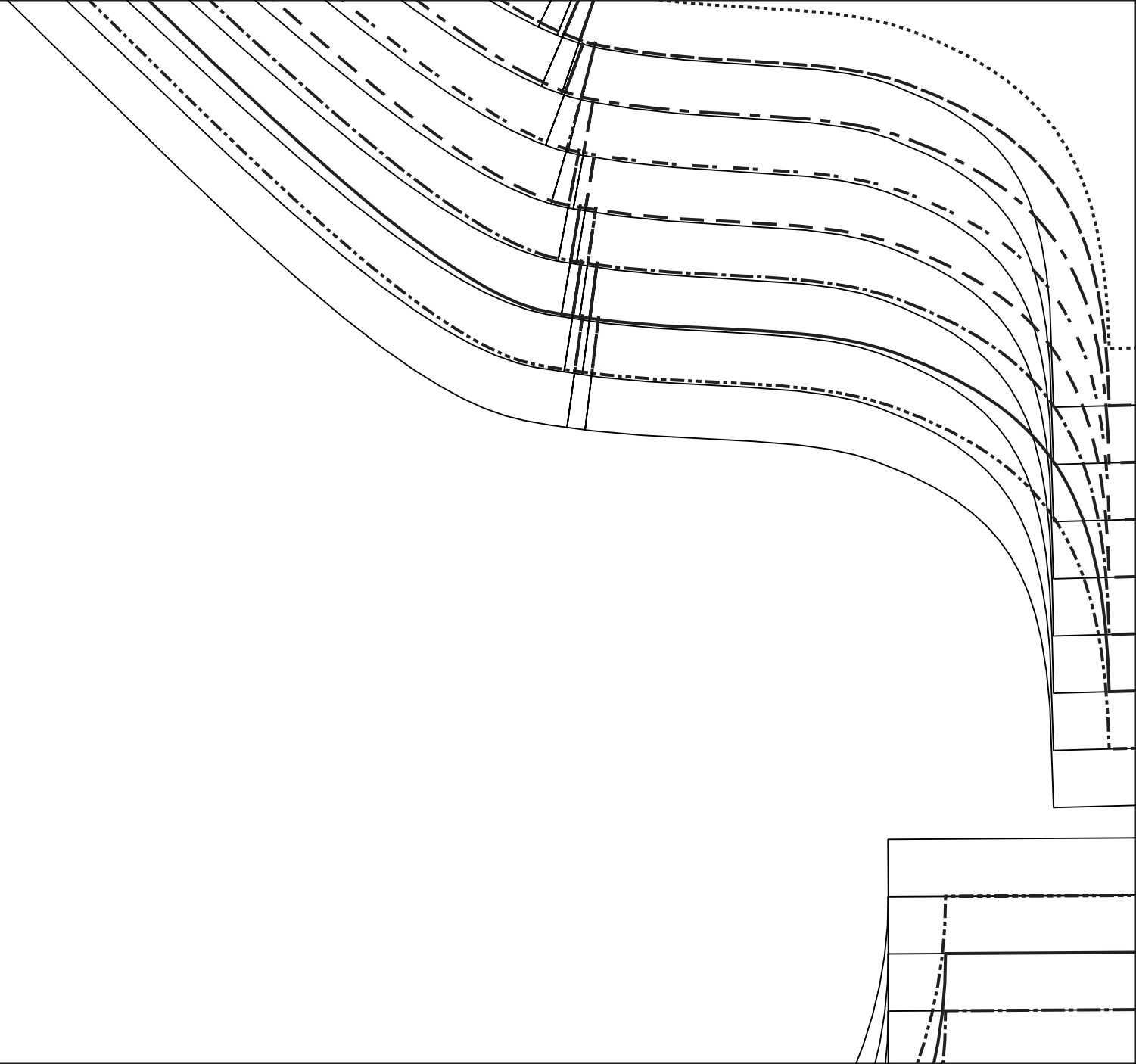

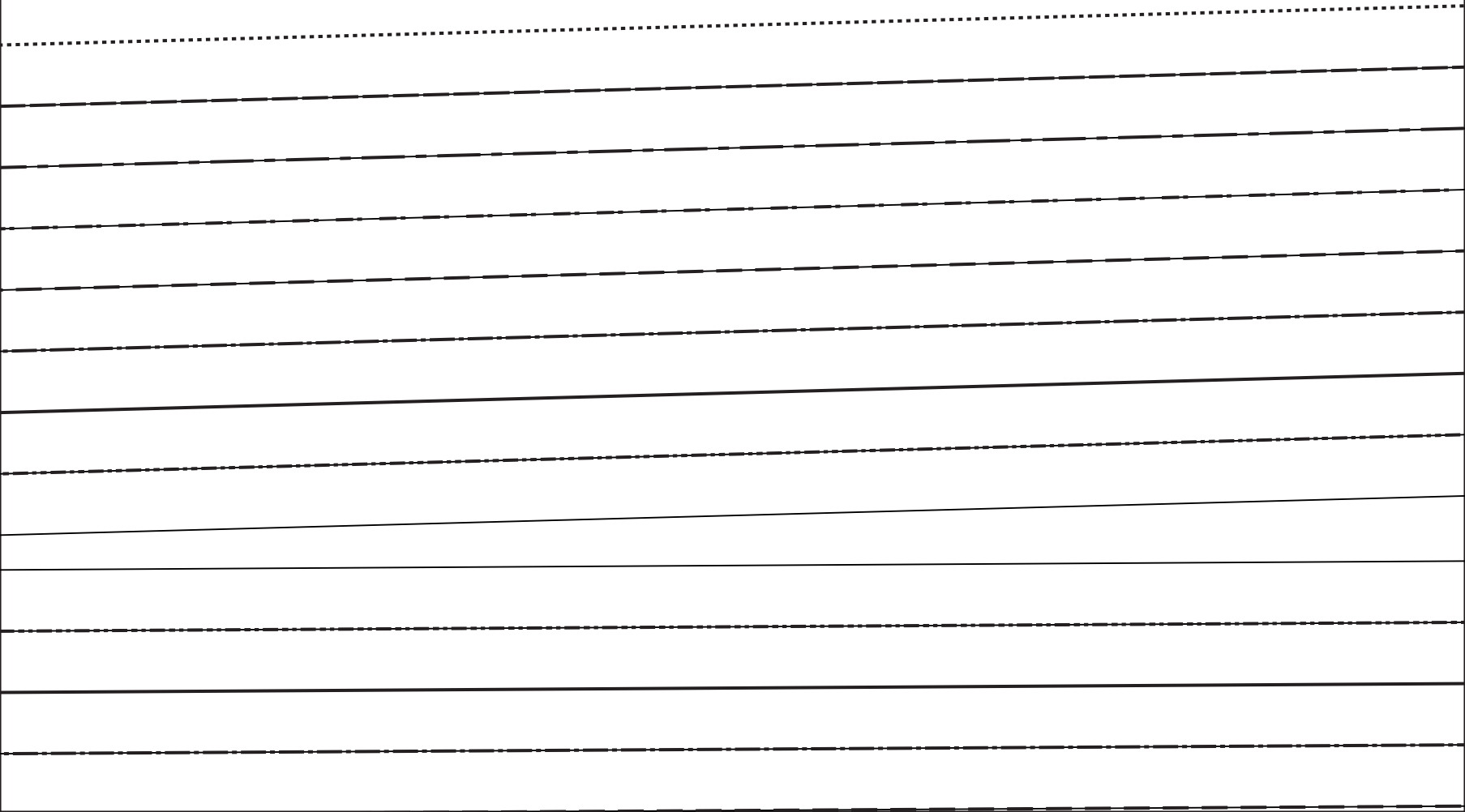

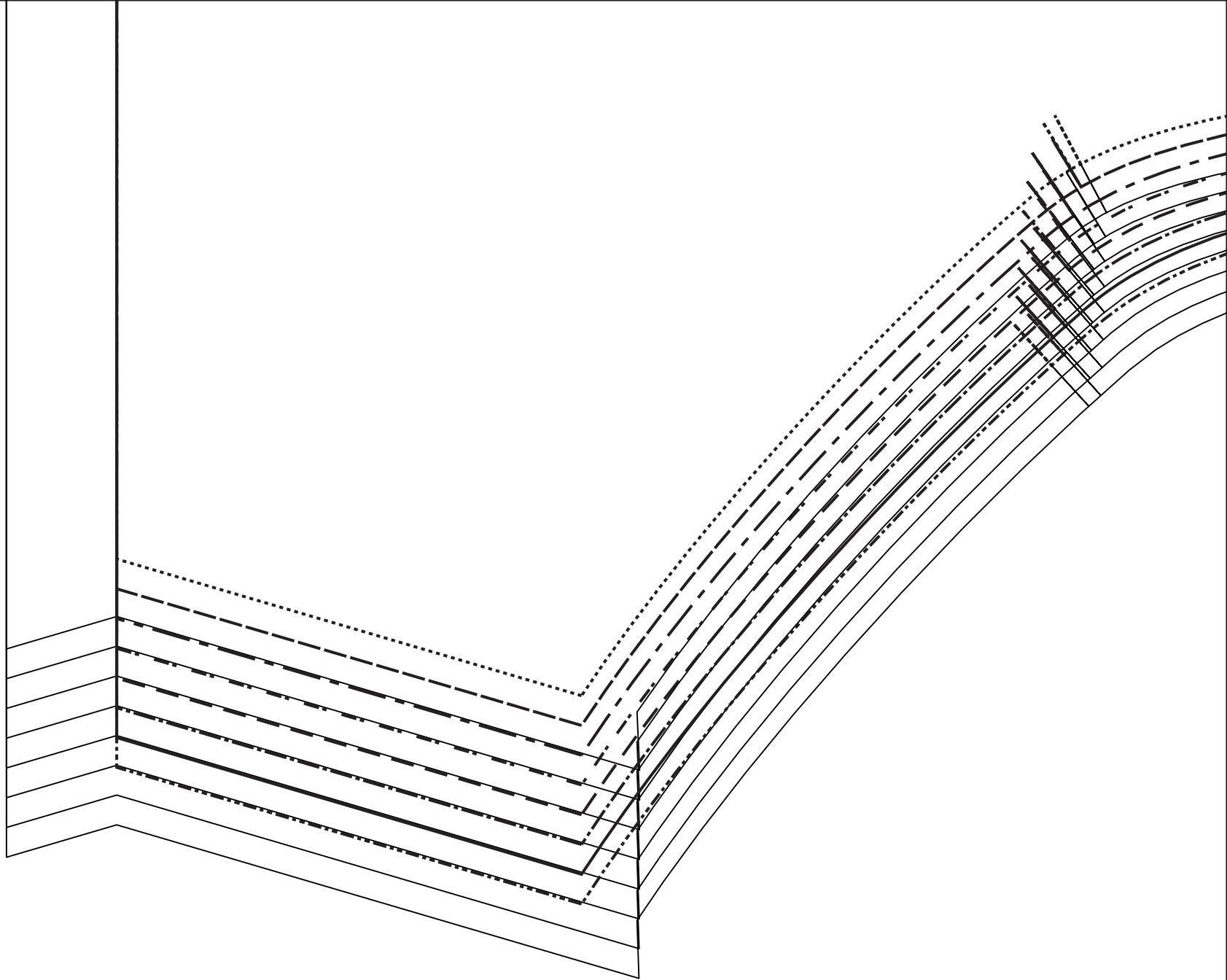

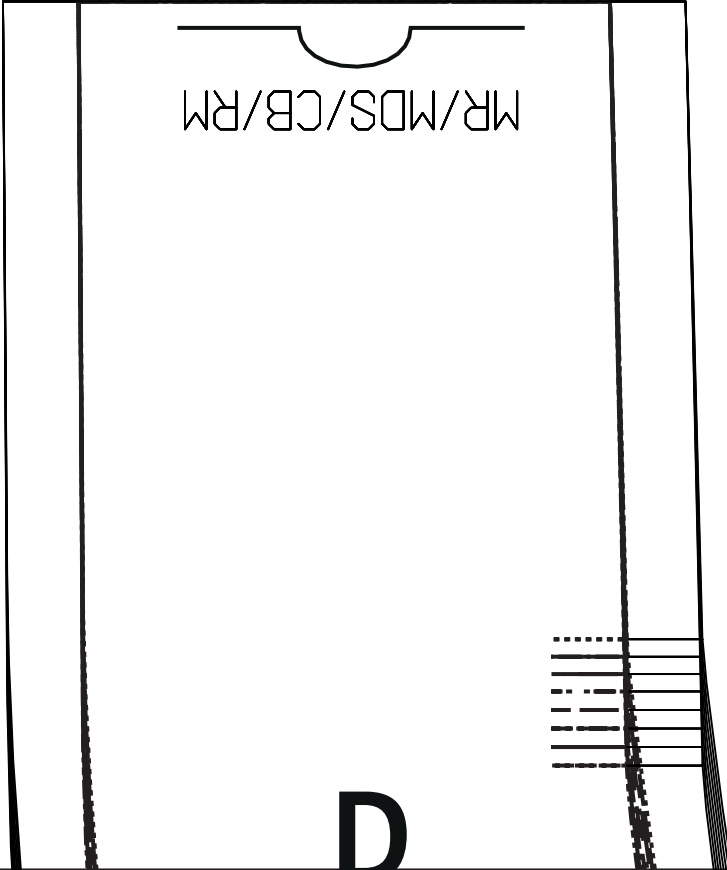
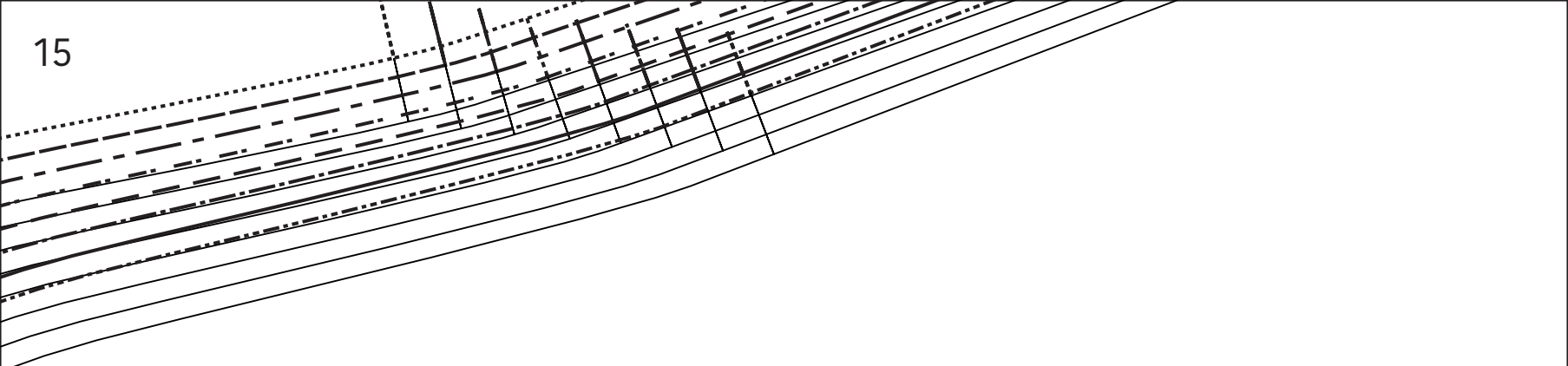

MR/MDS/CB/RM

D

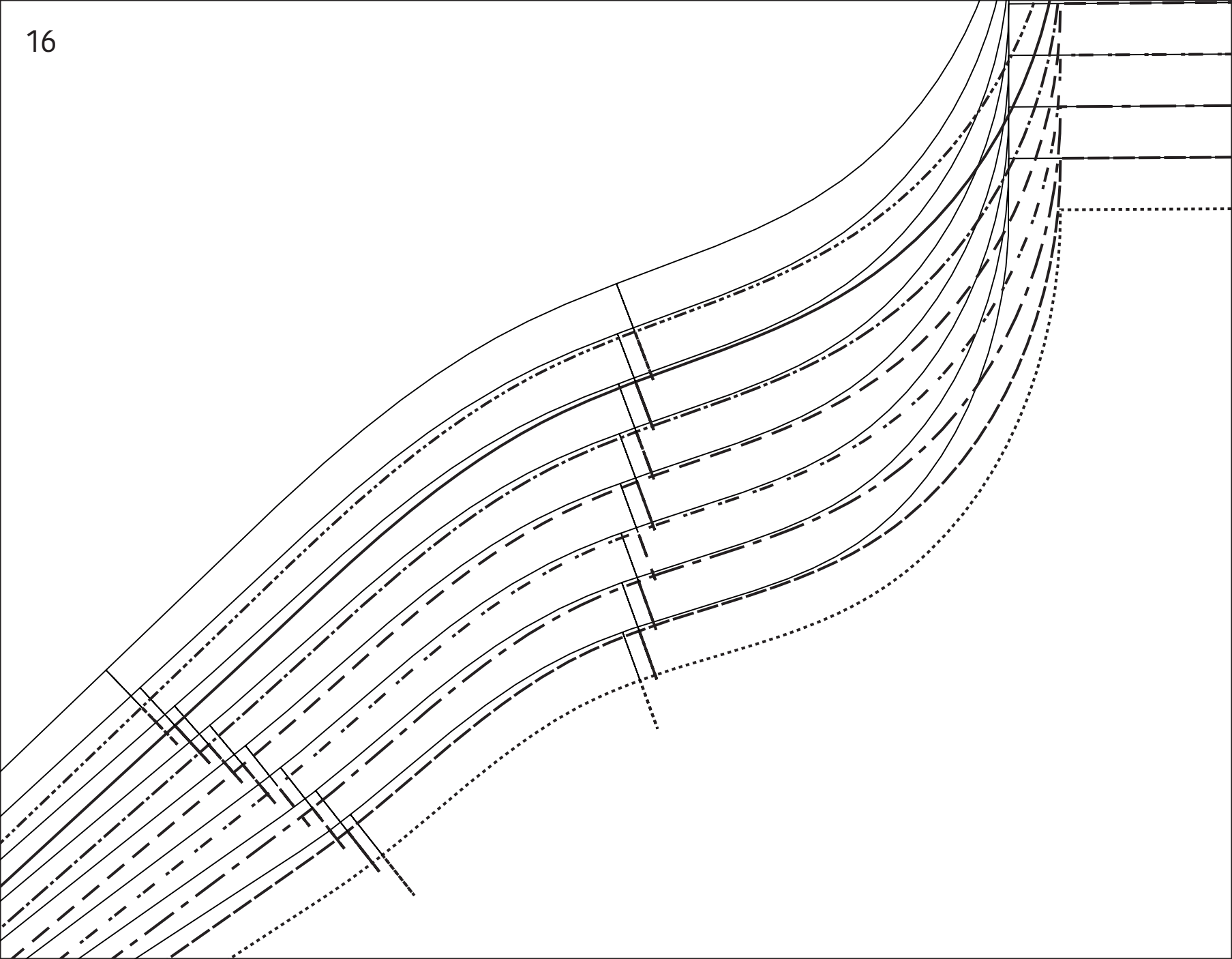

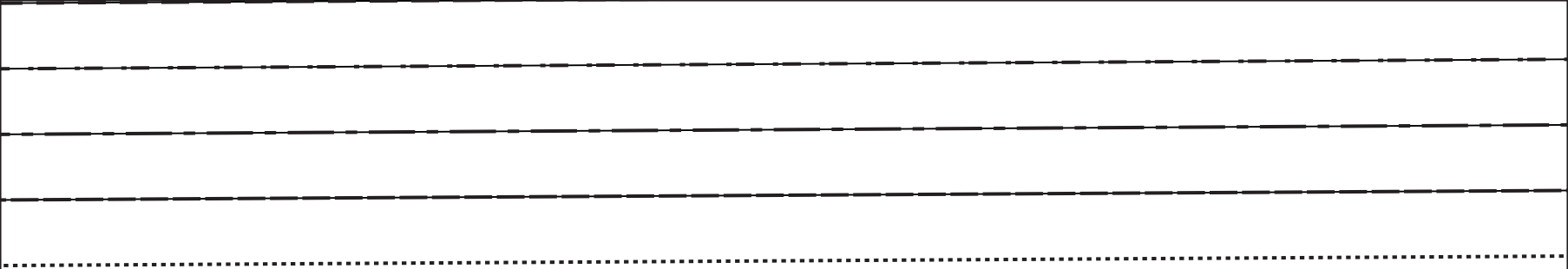

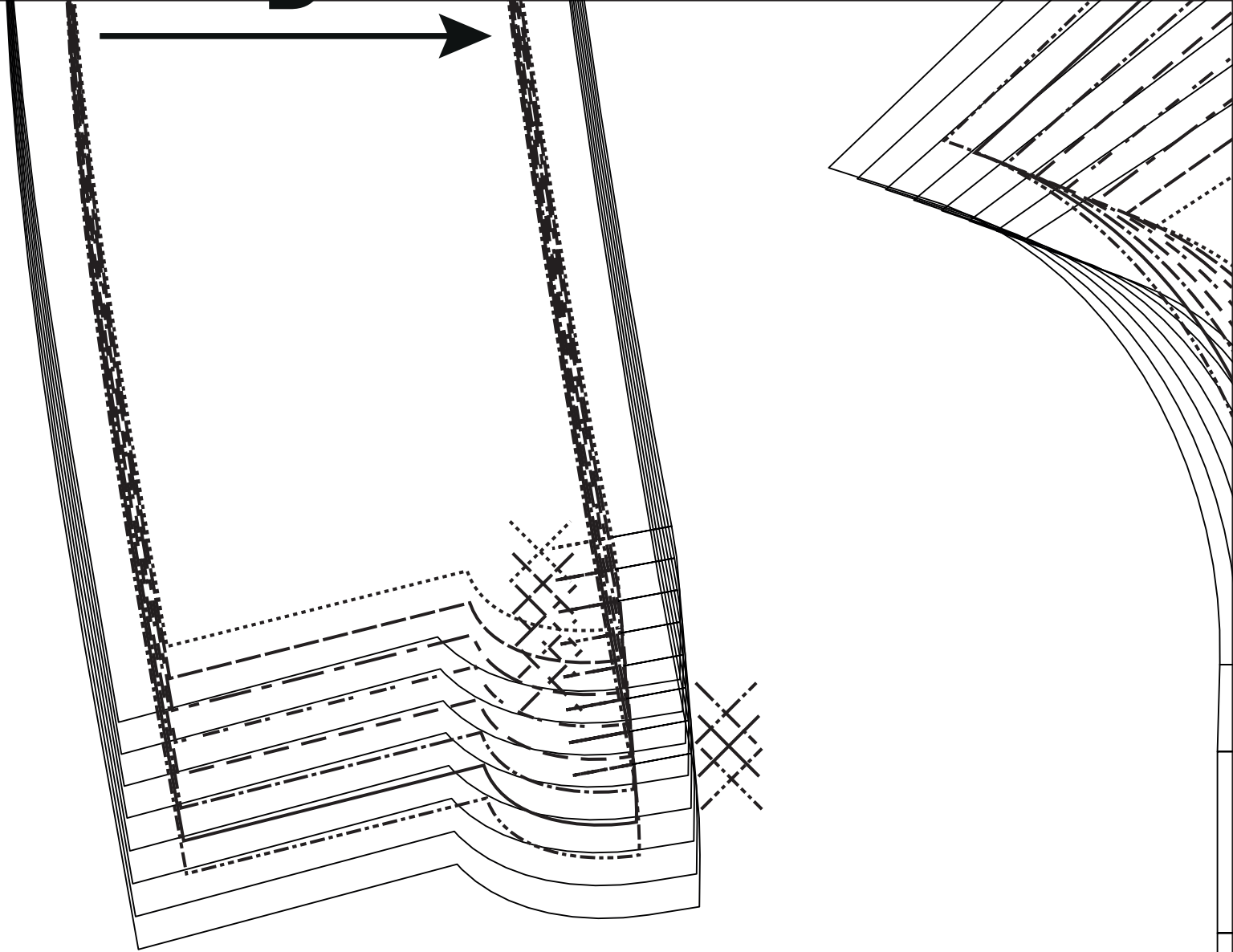

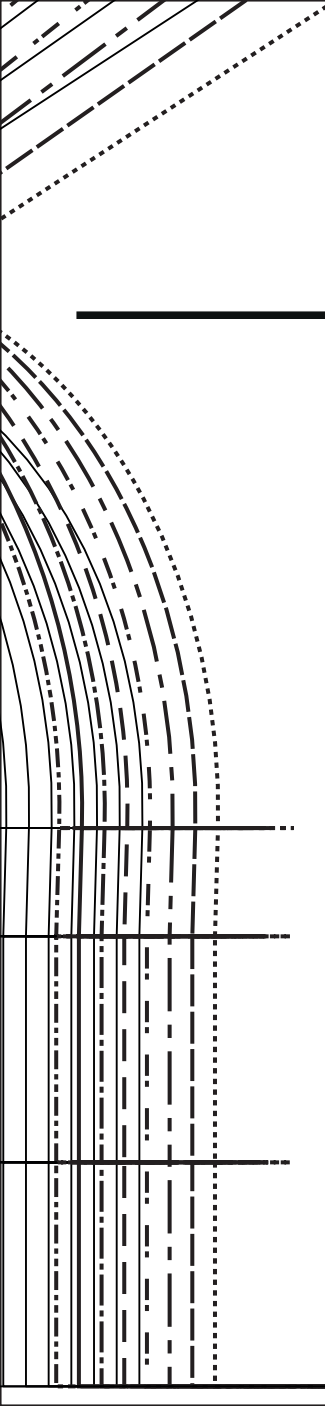

A

