

Henrietta

Blouse / Top / Bluse

Maten / Tailles / Sizes / Größen:

.....	30
-----	32
-----	34
- . - . - . - . - . - . - . - . - .	36
-----	38
-----	40
=====	42
-----	44
-----	46
-----	48

Patroondelen / Pièces du patron / Pattern pieces / Schnittteile:

- A** voorpand / devant / front panel /
Vorderteil
- B** rugpand / dos / back panel /
Rückenteil
- C** zoomboord / bord ourlet / cuff /
Saumbund
- D** mouw / manche / sleeve / Ärmel
- E** beleg RP / parementure du dos /
facing BP / Besatz RT

Patroonschema / Schéma du Patron / Pattern Diagram / Übersichtsplan zum Zusammenkleben

1	2	3	4	5	6
7	8	9	10	11	12
13	14	15	16	17	18
X 19	X 20	21	22	23	

Controlevierkant / Carré de controle / Test square / Kontrollquadrat

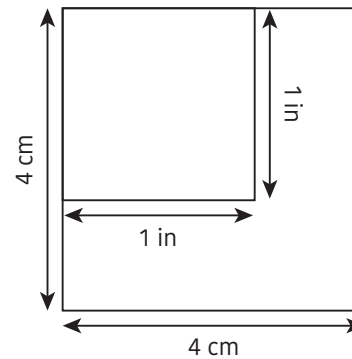

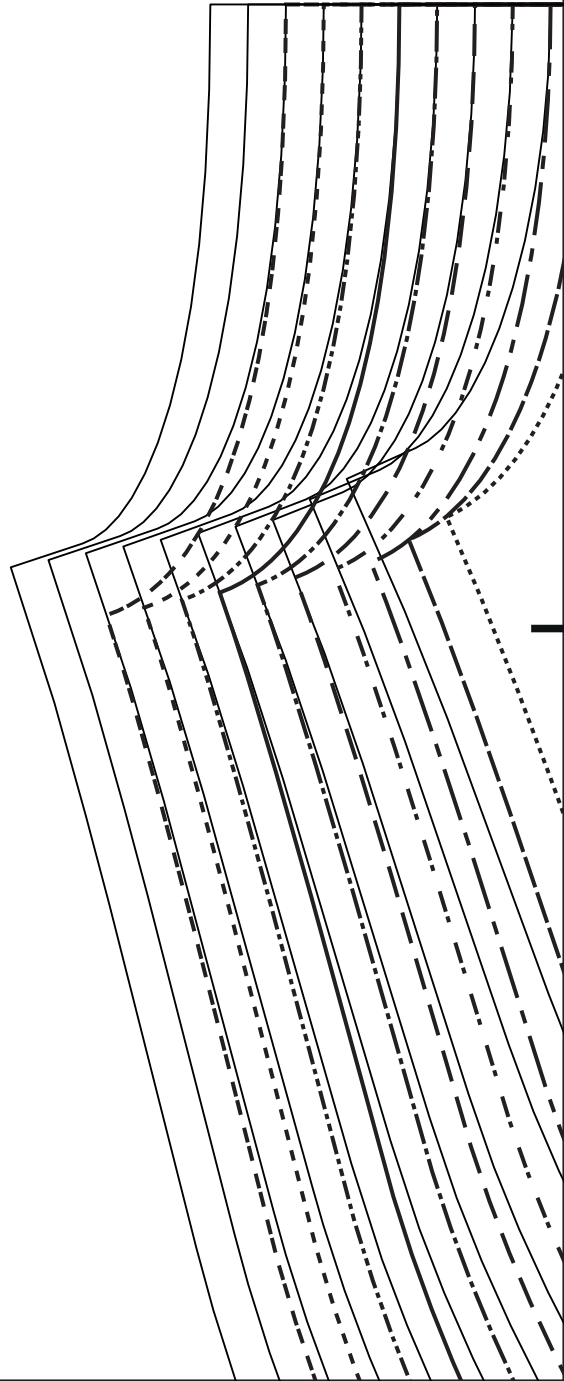

MR/MDS/CB/RM



B

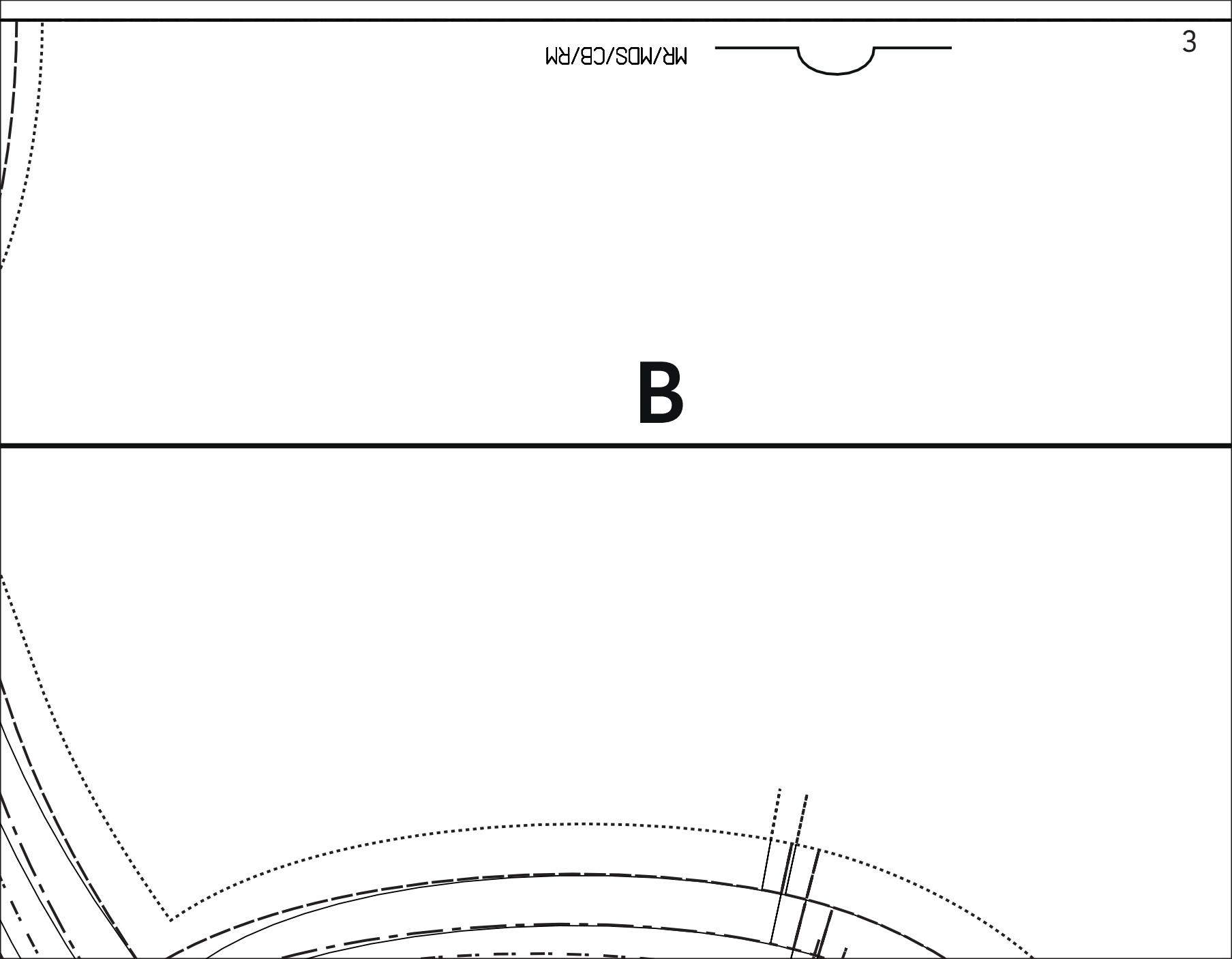

4

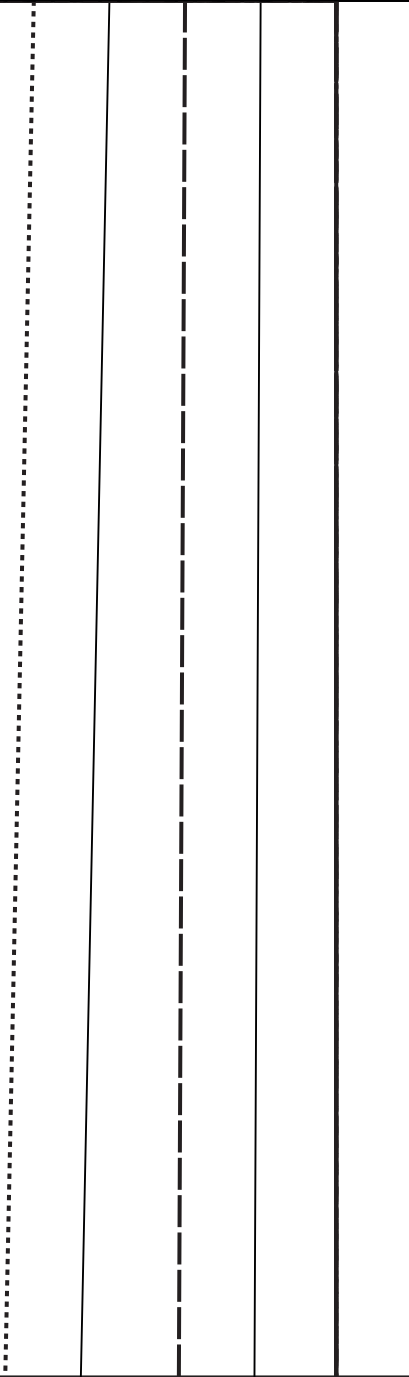

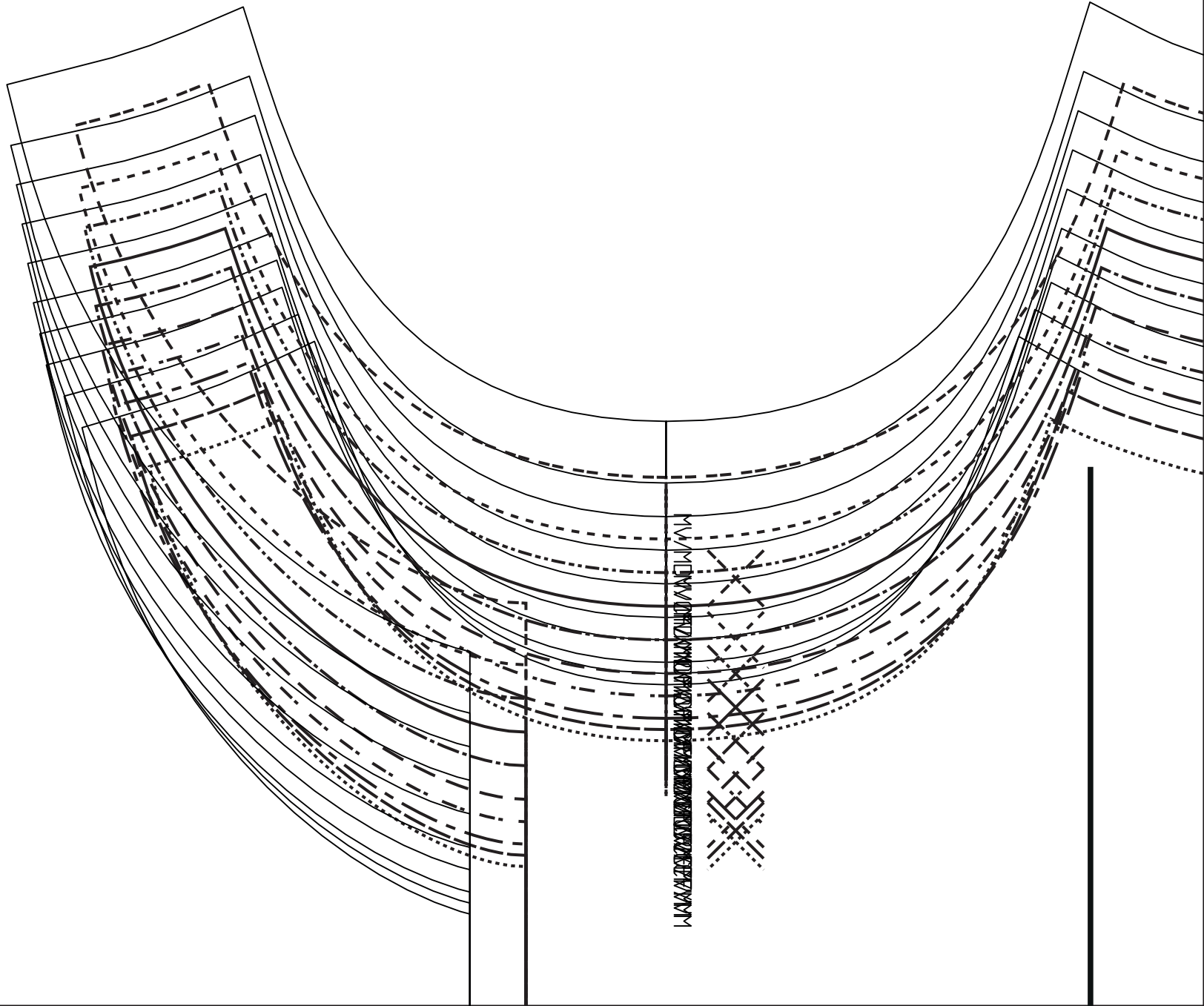

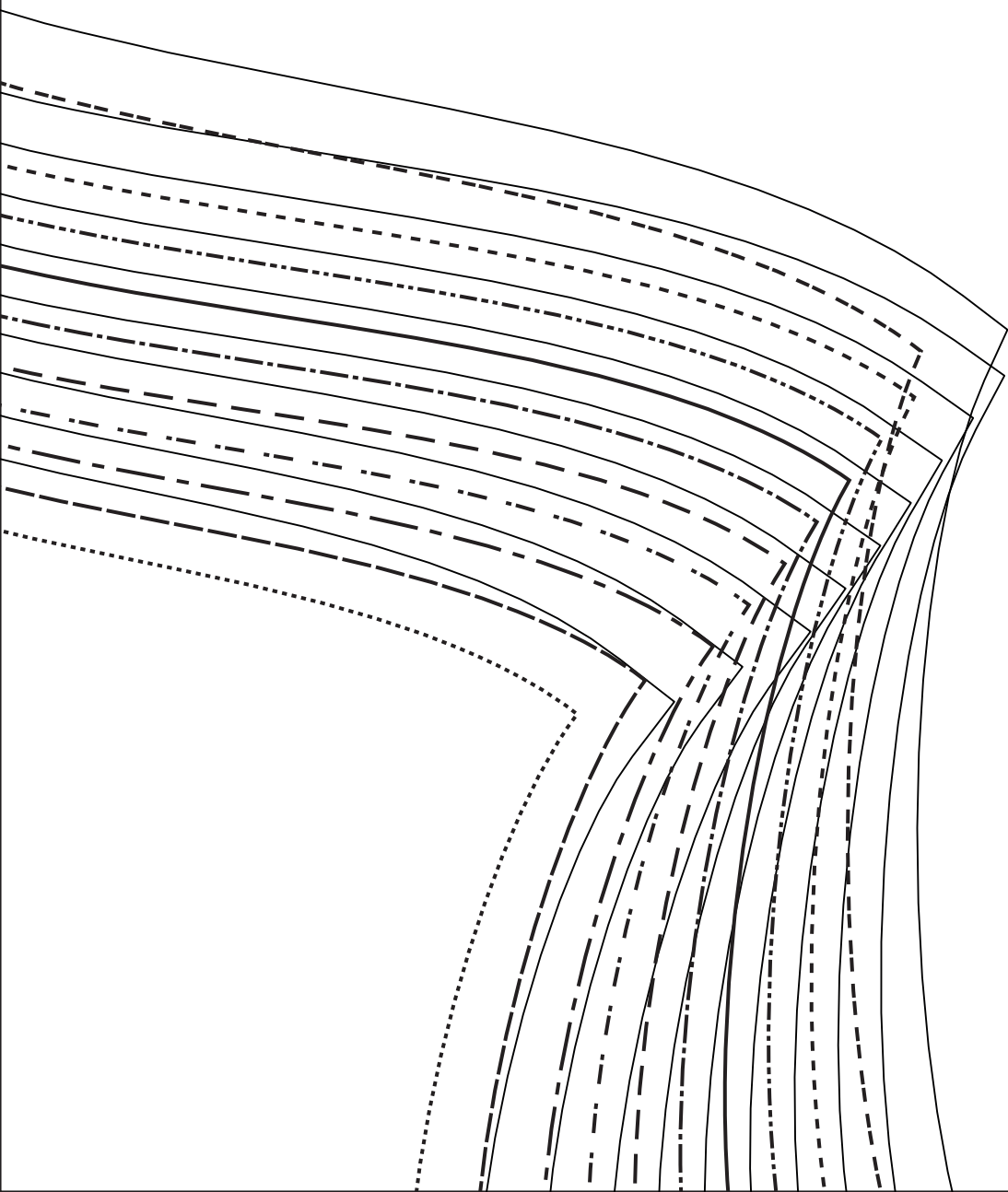

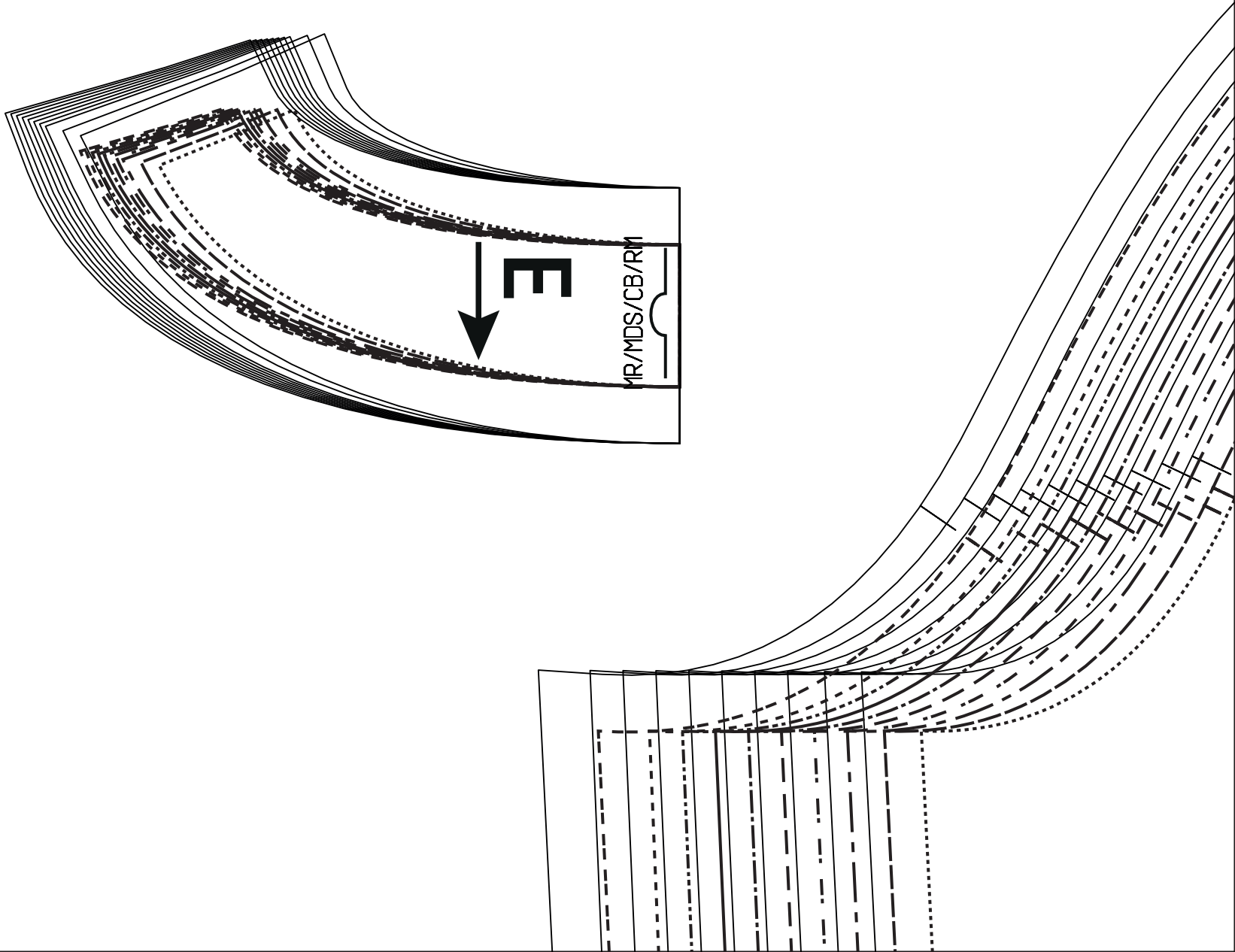

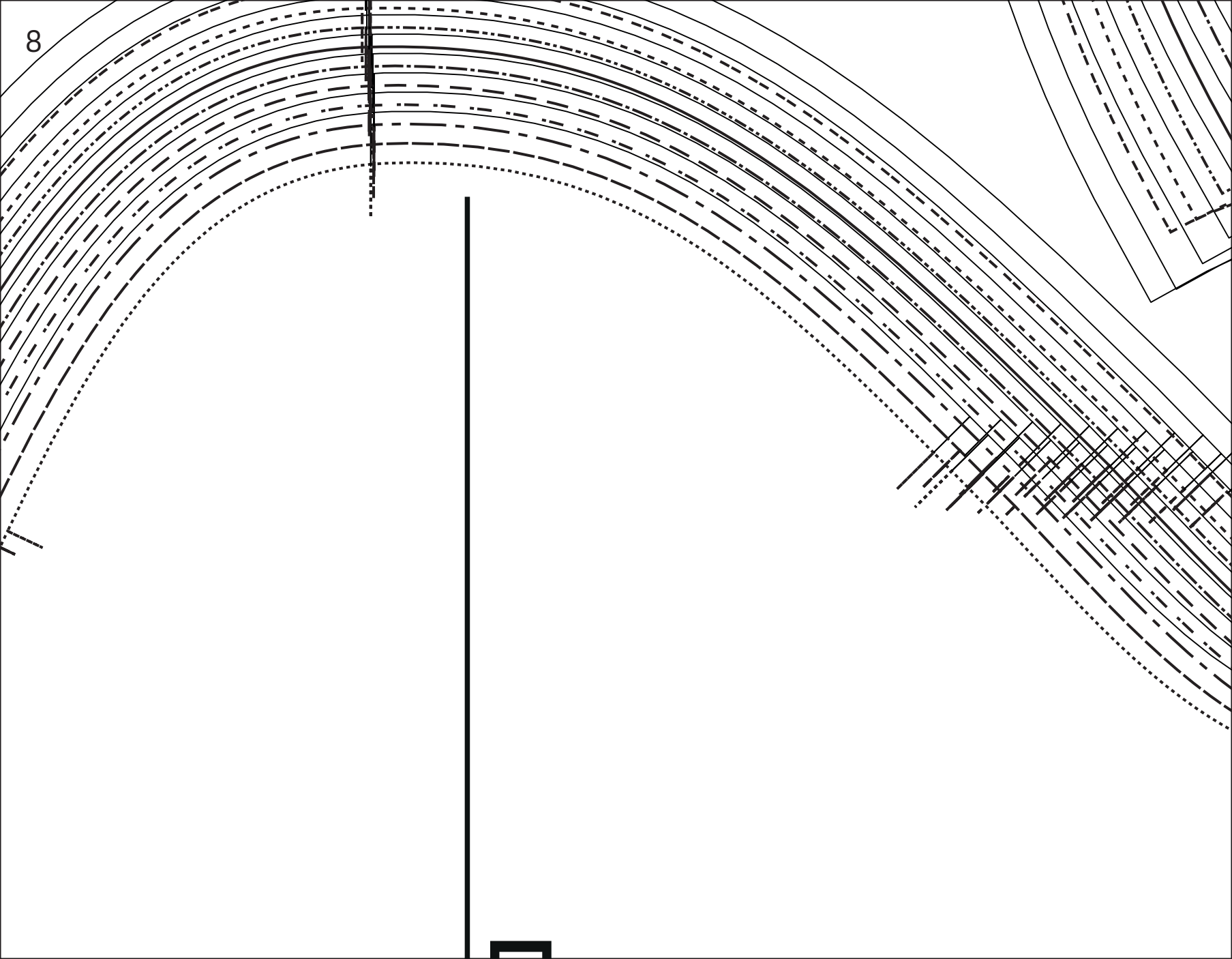

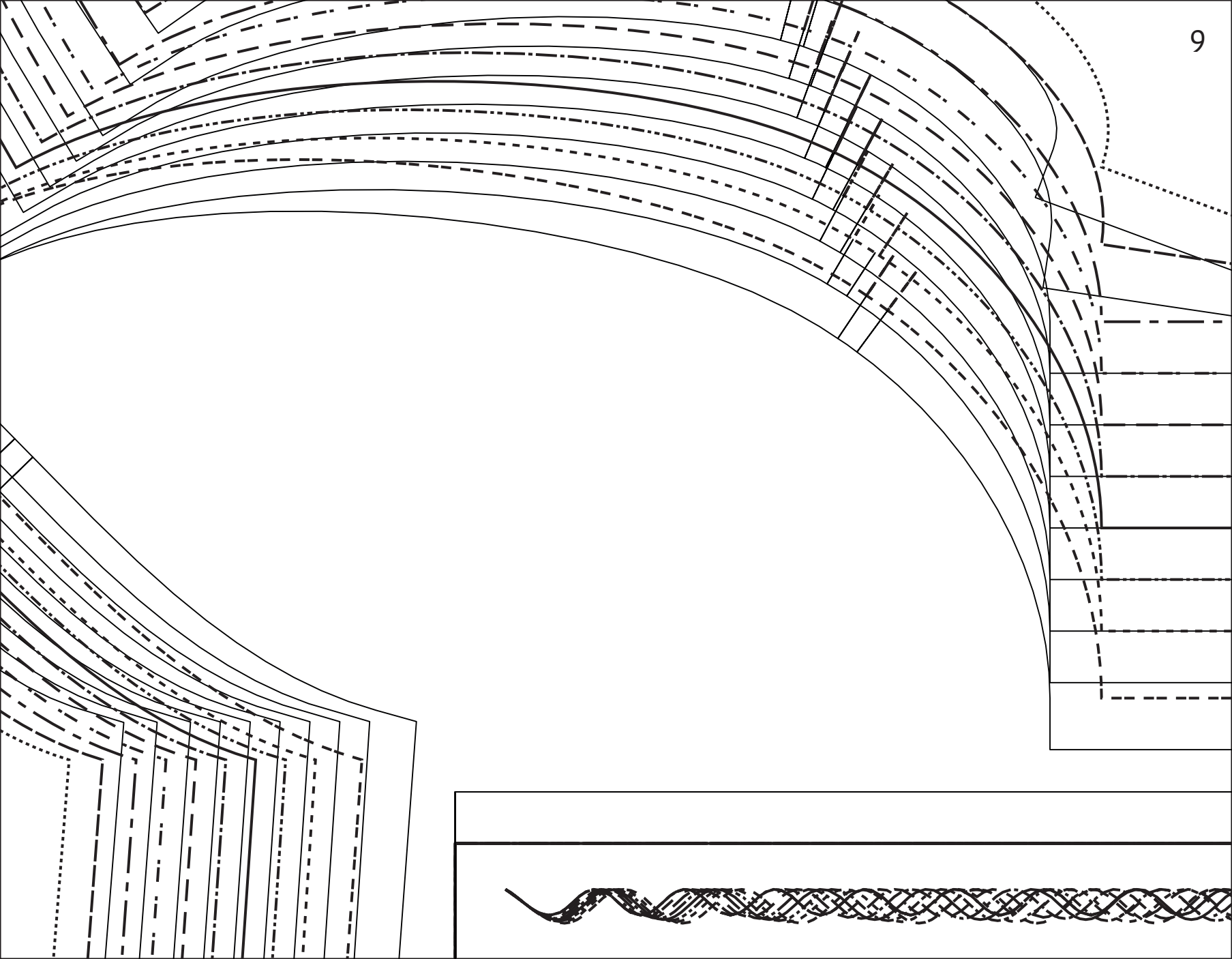

10

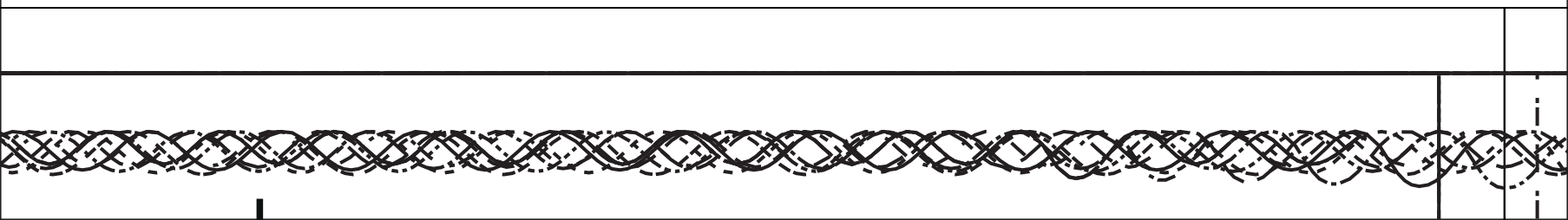
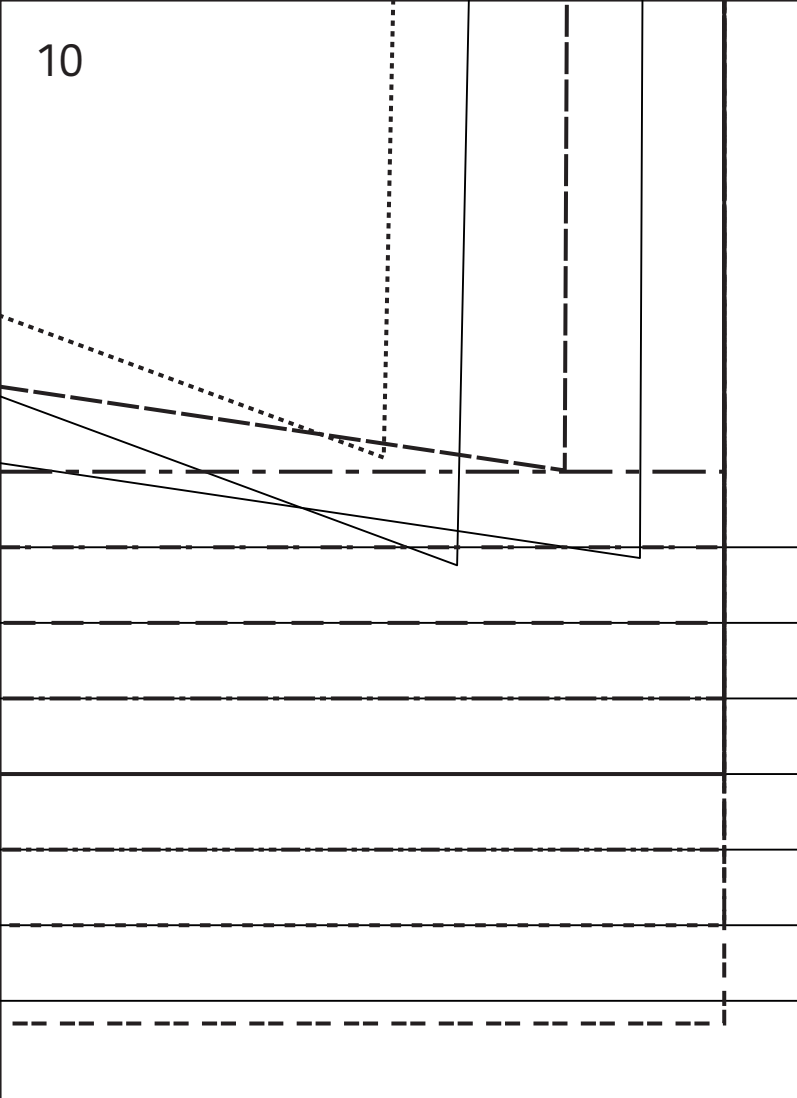

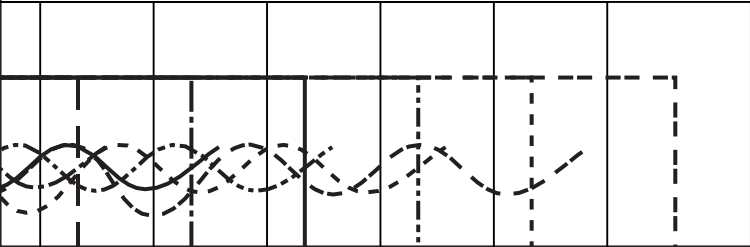

MV/MDV/CFM



A



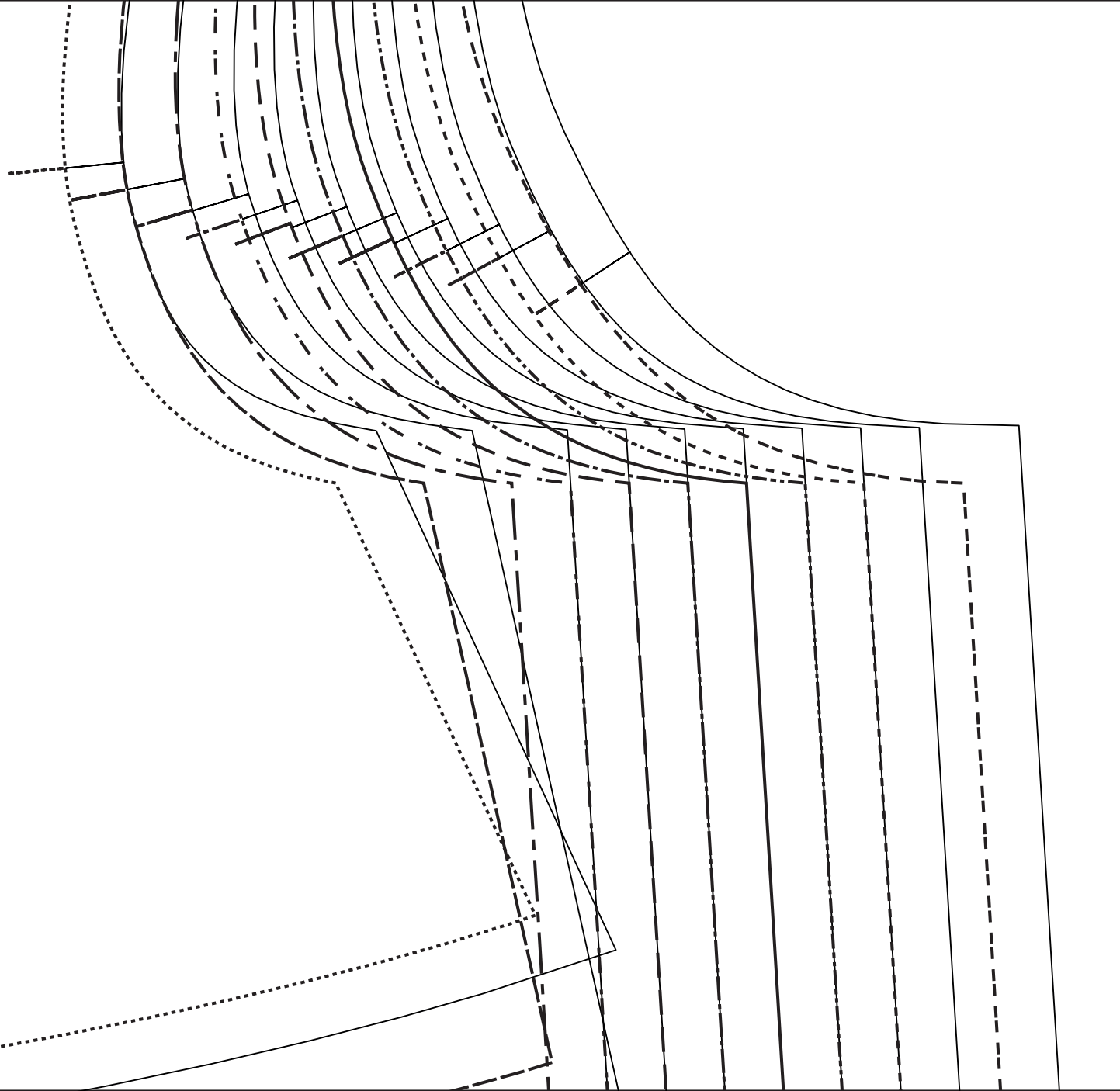

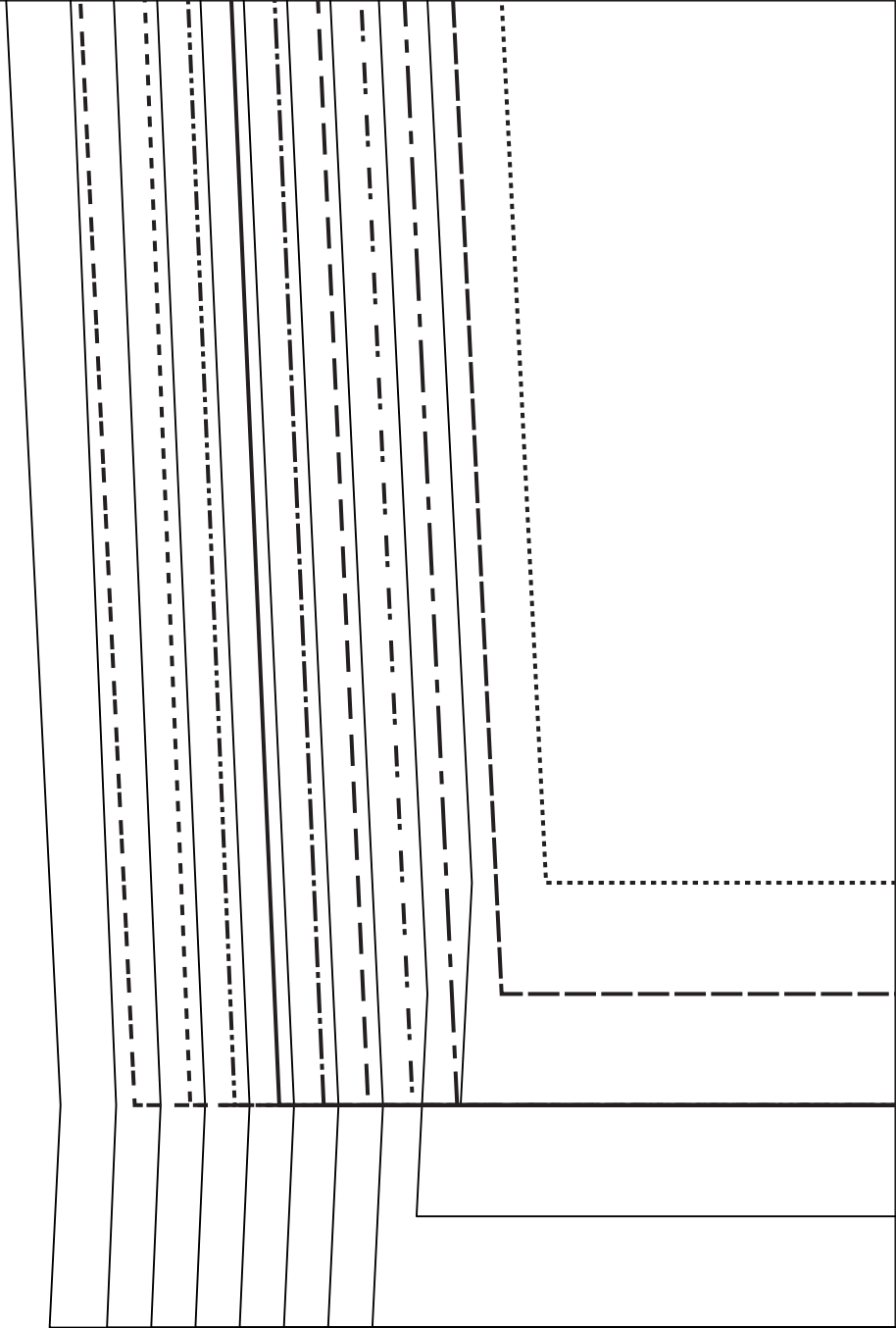

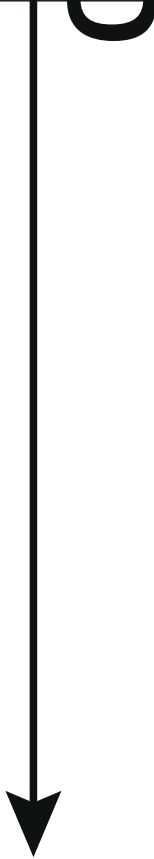

NV/MDV/CF/VM



MR/MDS/CB/RM

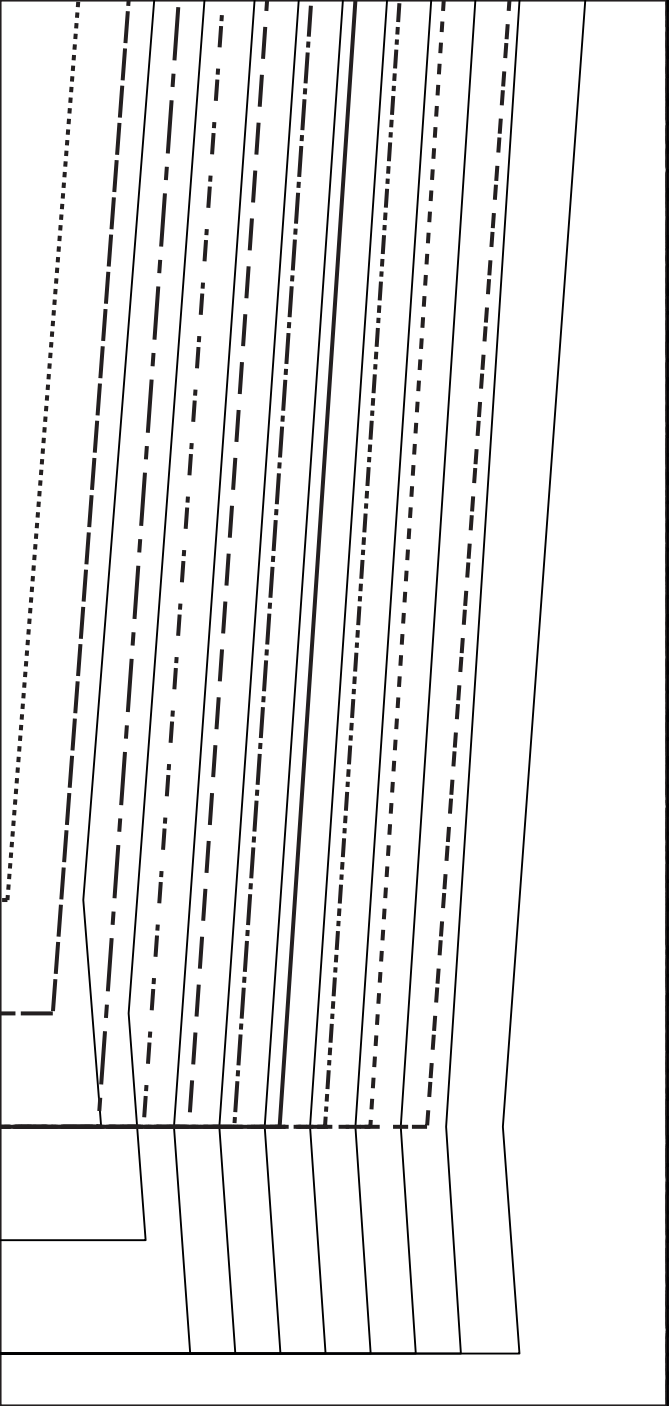

C



