

# Cyriel

## Short / Shorts

### Maten / Tailles / Sizes / Größen:

.....	92
-----	98
-----	104
- . - . - . - . - . - . - . - . - .	110
-----	116
-----	122 / 128
—————	134 / 140
-----	146 / 152
.....	158 / 164
-----	170 / 176

### Patroondelen / Pièces du patron / Pattern pieces / Schnittteile:

- A** voorpand / devant / front panel /  
Vorderteil
- B** rugpand / dos / back panel /  
Rückenteil
- C** plat stuk / empiècement / yoke /  
Besatz
- D** zak VP / poche DV / front pocket /  
Tasche VT
- E** zak RP / poche DS / back pocket /  
Tasche RT
- F** tailleband / ceinture rapportée /  
waistband / Taillenzbund

Patroonschema / Schéma du Patron / Pattern Diagram /  
Übersichtsplan zum Zusammenkleben

1	2	3	4	5	6
7	8	9	10	11	12
13	14	15			

Controlevierkant / Carré de controle  
/ Test square / Kontrollquadrat

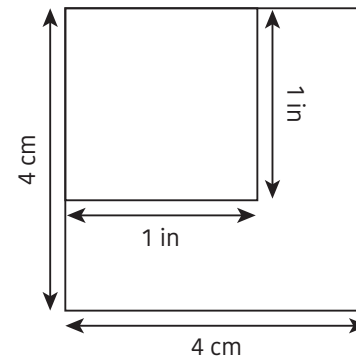

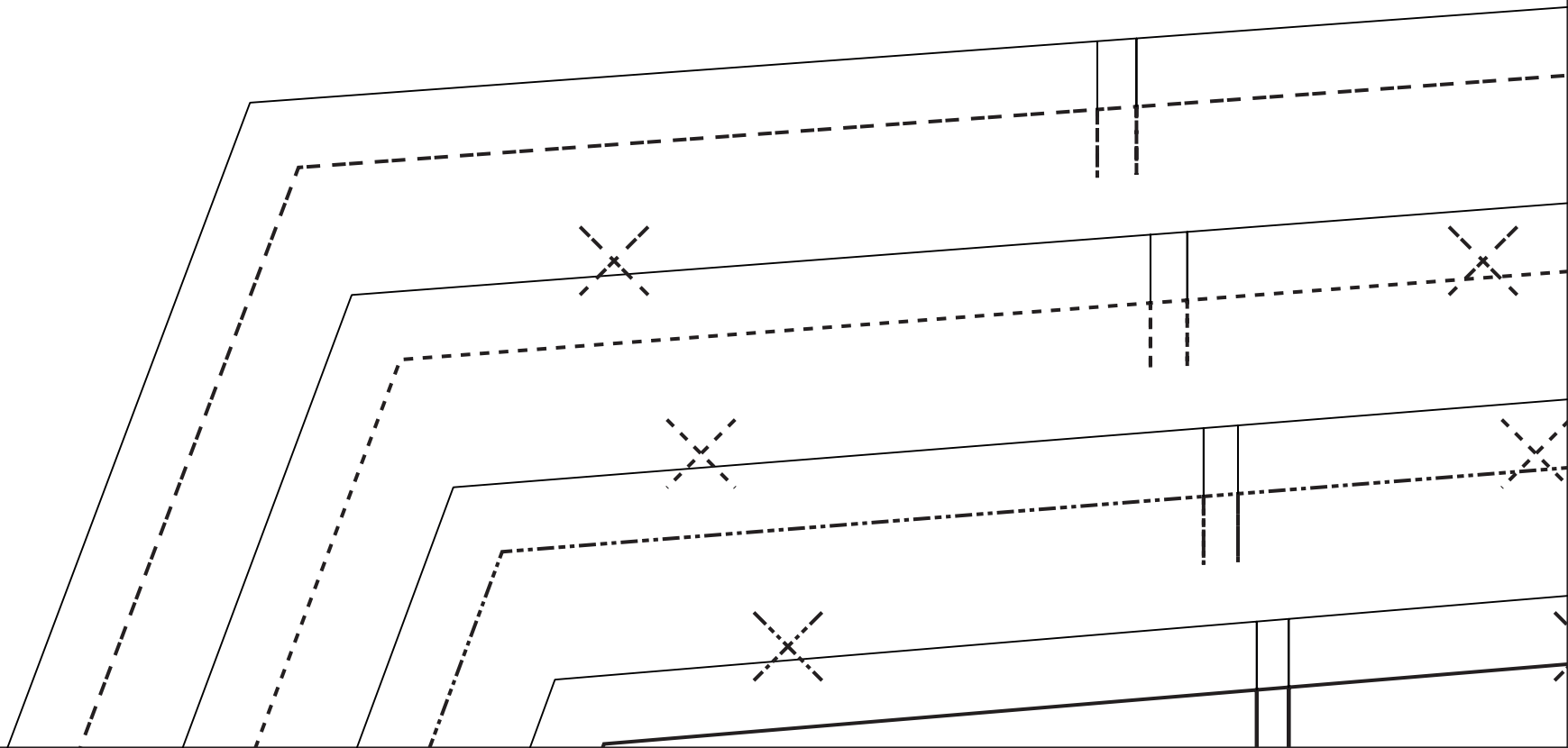

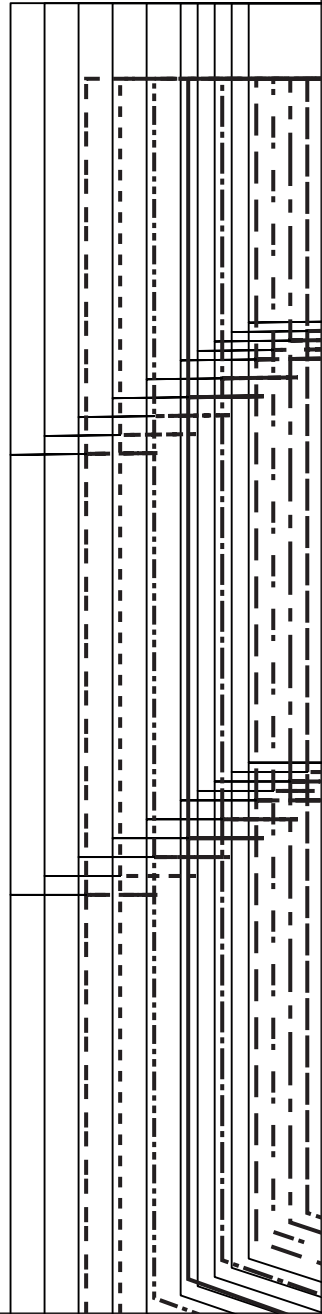
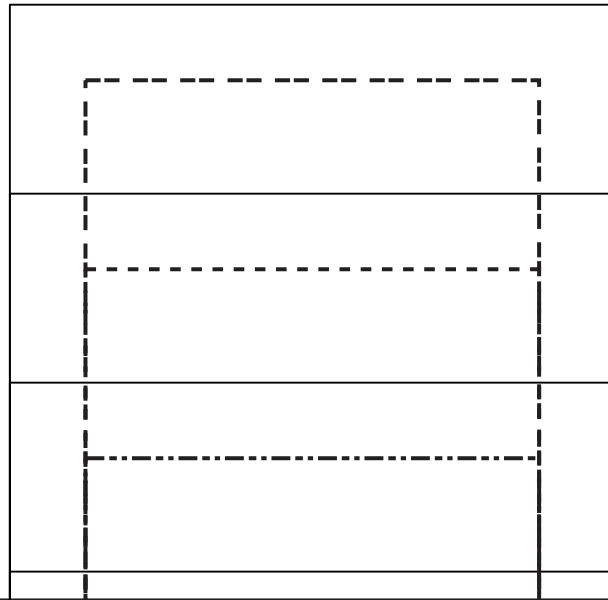
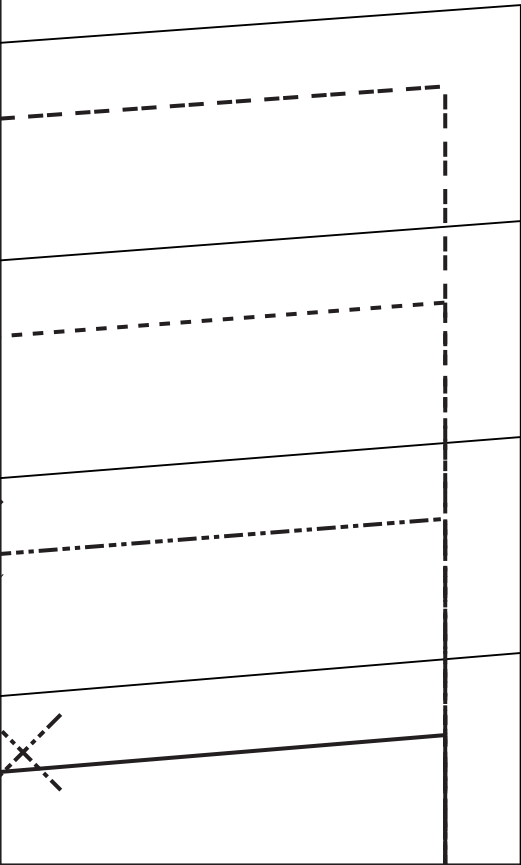

4

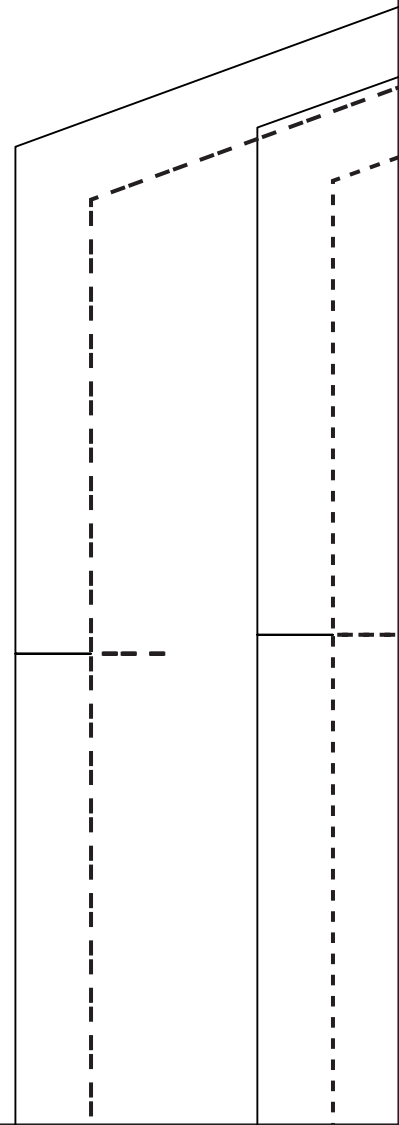
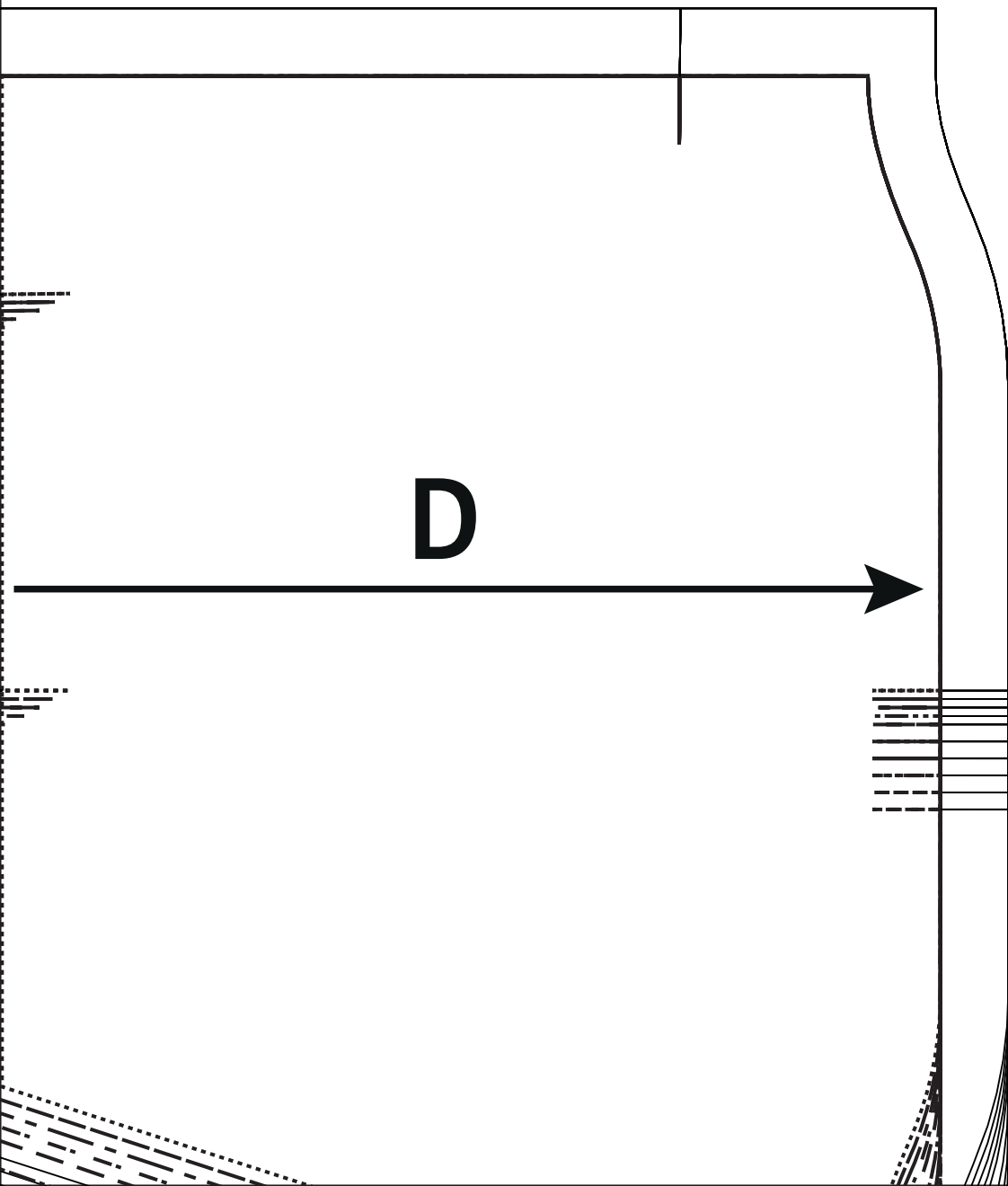

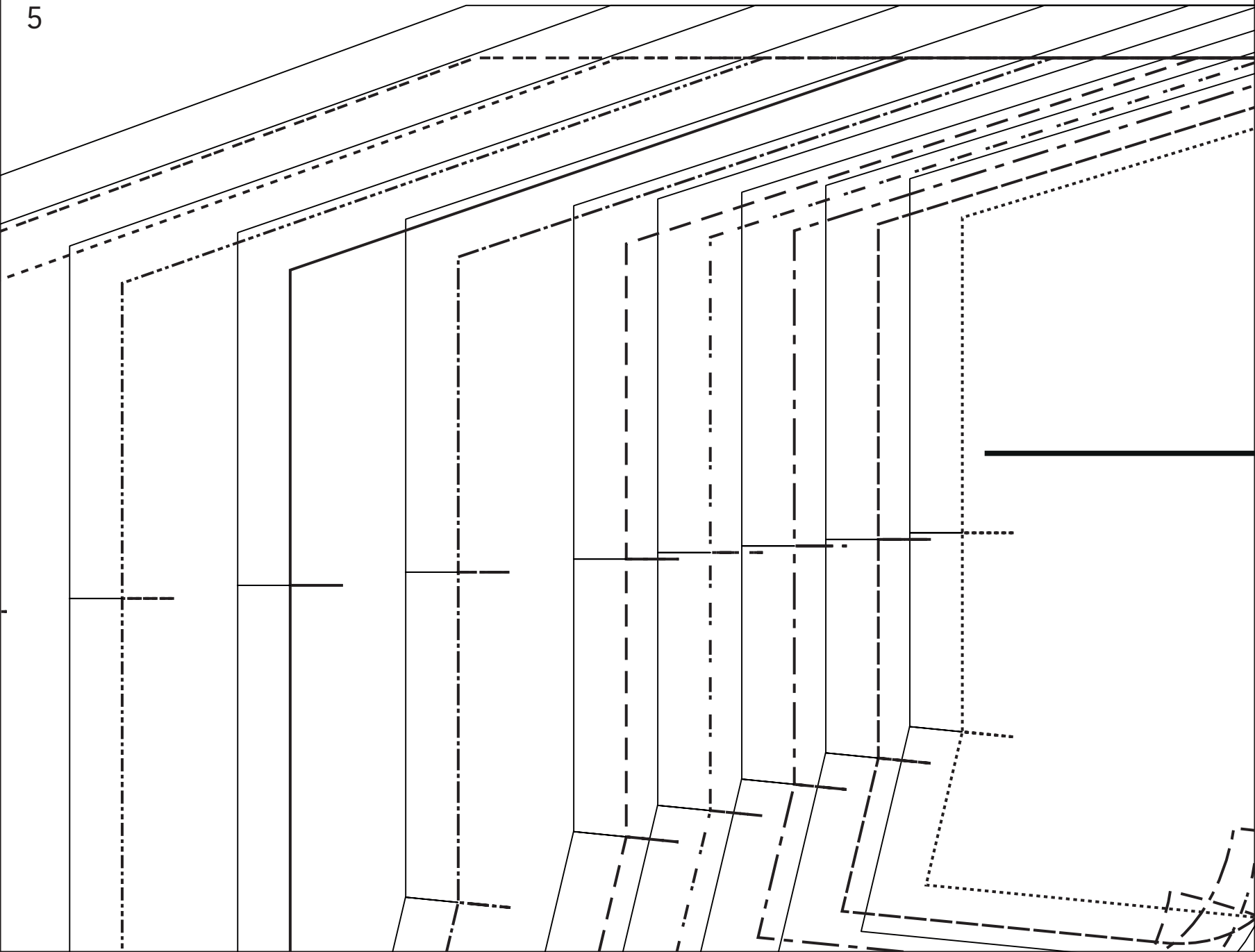

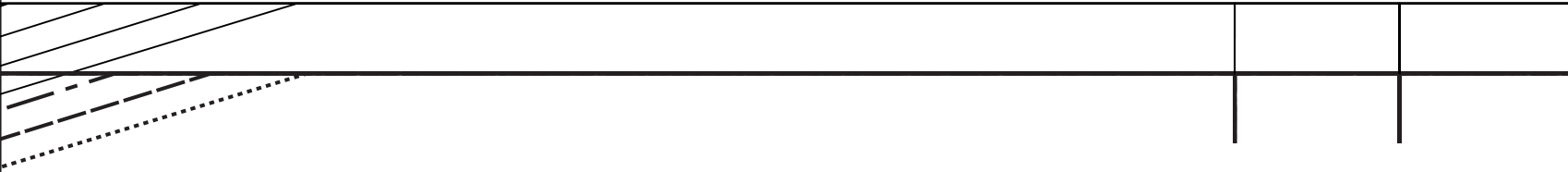

**A**

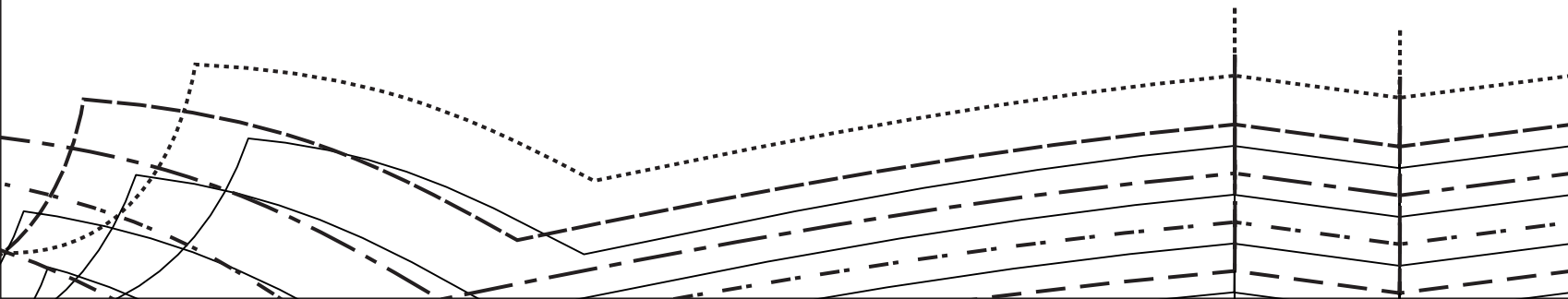

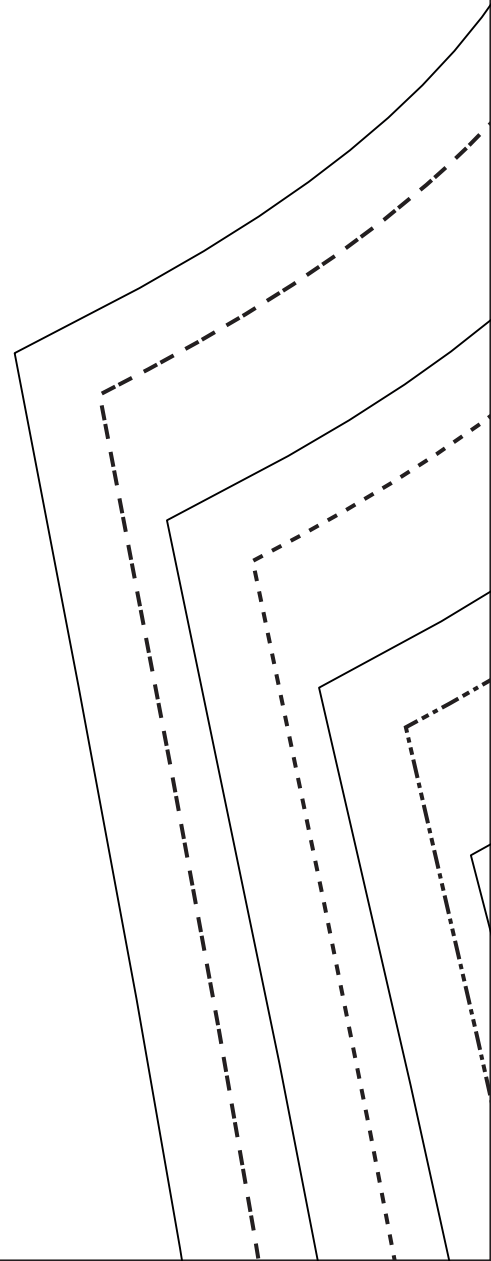

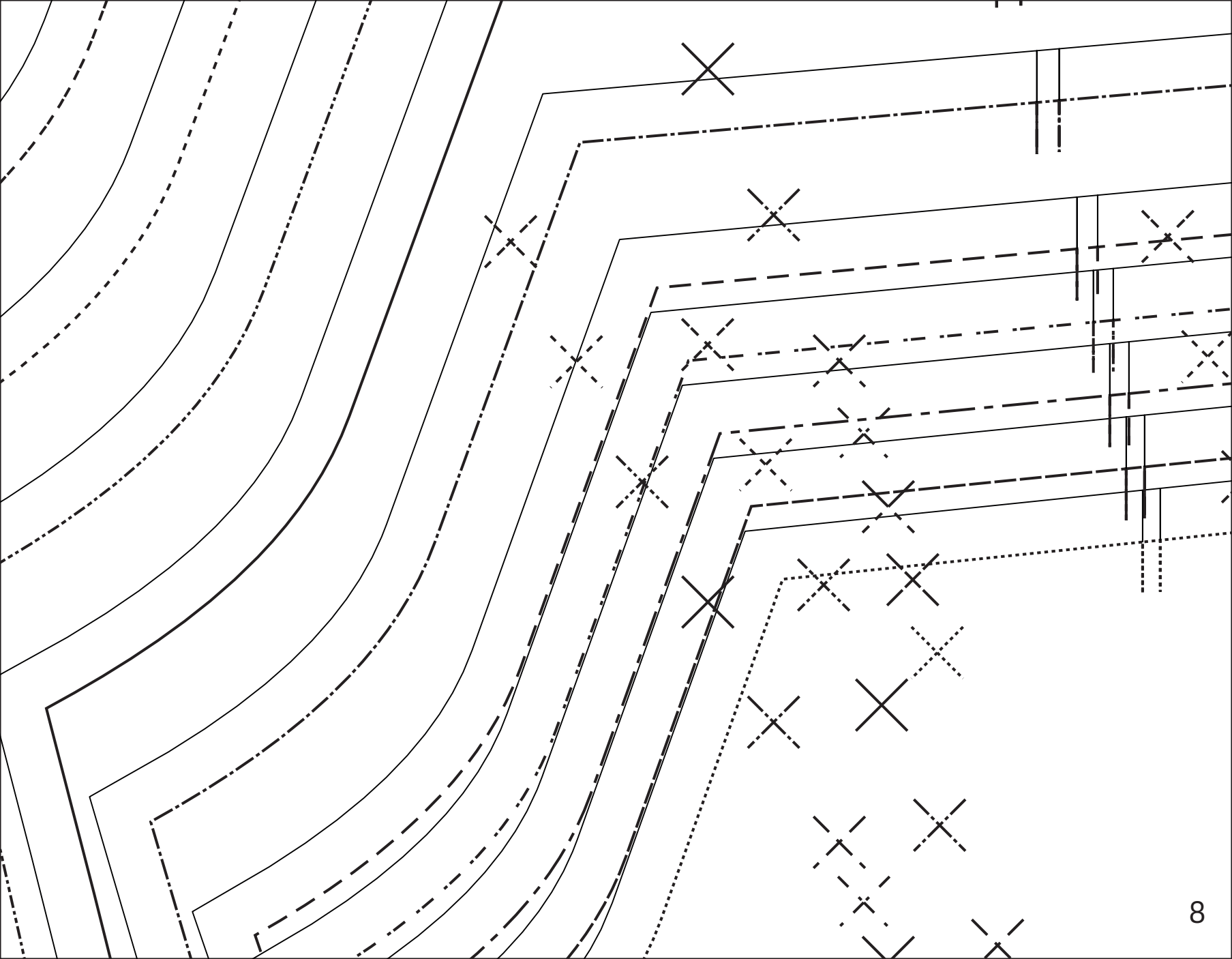



Handwriting practice section with a vertical margin line on the left. It contains several rows of lines for tracing and writing. The first row has a solid line with an 'X' at the start and a dashed line. The second row has a dashed line with an 'X' at the start. The third row has a dashed line. The fourth row has a dashed line with an 'X' at the start. The fifth row has a dashed line with a triangle at the start. The sixth row has a dashed line with a triangle at the start. The seventh row has a dotted line with a triangle at the start. The eighth row has a solid line with an 'X' at the start. The ninth row has a dashed line with an 'X' at the start. The tenth row has a dotted line with an 'X' at the start. The eleventh row has a solid line with an 'X' at the start. The twelfth row has a dashed line with an 'X' at the start. The thirteenth row has a dotted line with an 'X' at the start. The number '9' is written in the bottom left corner.

Handwriting practice section with a vertical margin line on the left. It contains several rows of lines for tracing and writing. The first row has a solid line. The second row has a dashed line. The third row has a solid line. The fourth row has a dashed line. The fifth row has a solid line. The sixth row has a dashed line. The seventh row has a solid line. The eighth row has a dotted line. The ninth row has a solid line. The tenth row has a dashed line. The eleventh row has a solid line. The twelfth row has a dashed line. The thirteenth row has a solid line. The fourteenth row has a dashed line. The fifteenth row has a solid line. The sixteenth row has a dashed line. The seventeenth row has a solid line. The eighteenth row has a dashed line. The nineteenth row has a solid line. The twentieth row has a dashed line. The twenty-first row has a solid line. The twenty-second row has a dashed line. The twenty-third row has a solid line. The twenty-fourth row has a dashed line. The twenty-fifth row has a solid line. The twenty-sixth row has a dashed line. The twenty-seventh row has a solid line. The twenty-eighth row has a dashed line. The twenty-ninth row has a solid line. The thirtieth row has a dashed line. The thirtieth row has a solid line. The thirtieth row has a dashed line. The thirtieth row has a solid line. The thirtieth row has a dashed line.

Handwriting practice section with a vertical margin line on the left. It contains several rows of lines for tracing and writing. The first row has a solid line. The second row has a dashed line. The third row has a solid line. The fourth row has a dashed line. The fifth row has a solid line. The sixth row has a dashed line. The seventh row has a solid line. The eighth row has a dashed line. The ninth row has a solid line. The tenth row has a dashed line. The eleventh row has a solid line. The twelfth row has a dashed line. The thirteenth row has a solid line. The fourteenth row has a dashed line. The fifteenth row has a solid line. The sixteenth row has a dashed line. The seventeenth row has a solid line. The eighteenth row has a dashed line. The nineteenth row has a solid line. The twentieth row has a dashed line. The twentieth row has a solid line. The twentieth row has a dashed line. The twentieth row has a solid line. The twentieth row has a dashed line.

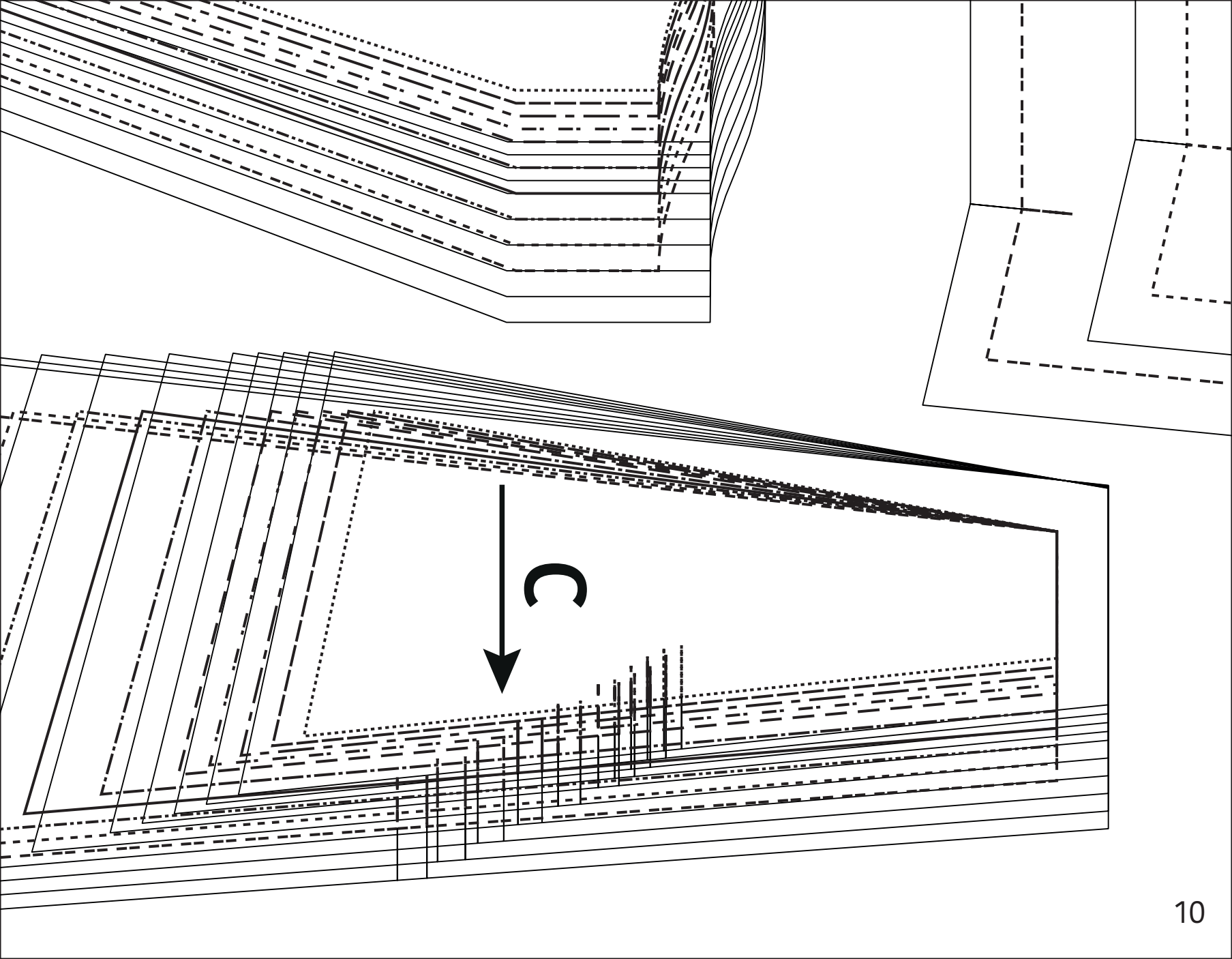

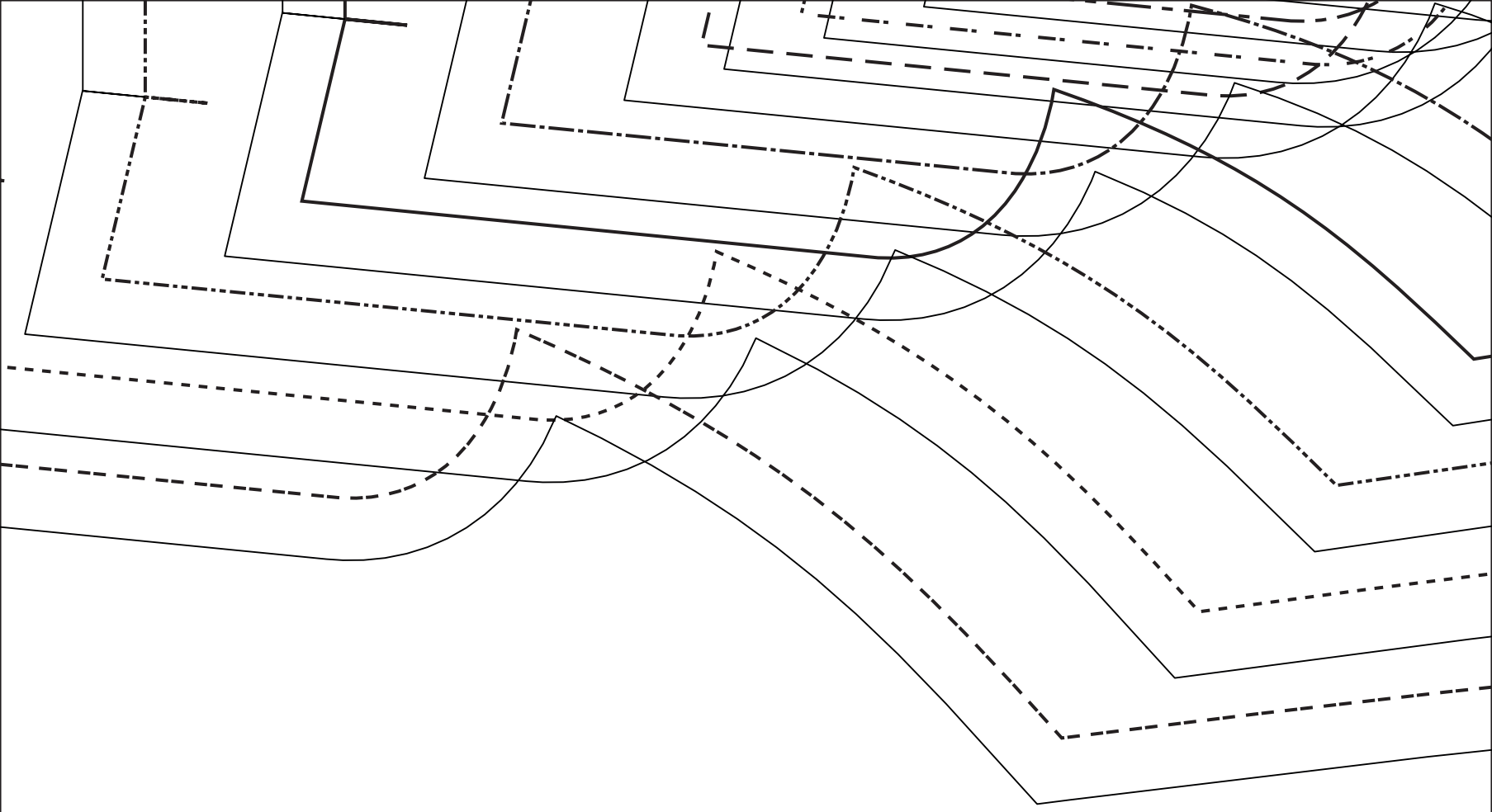

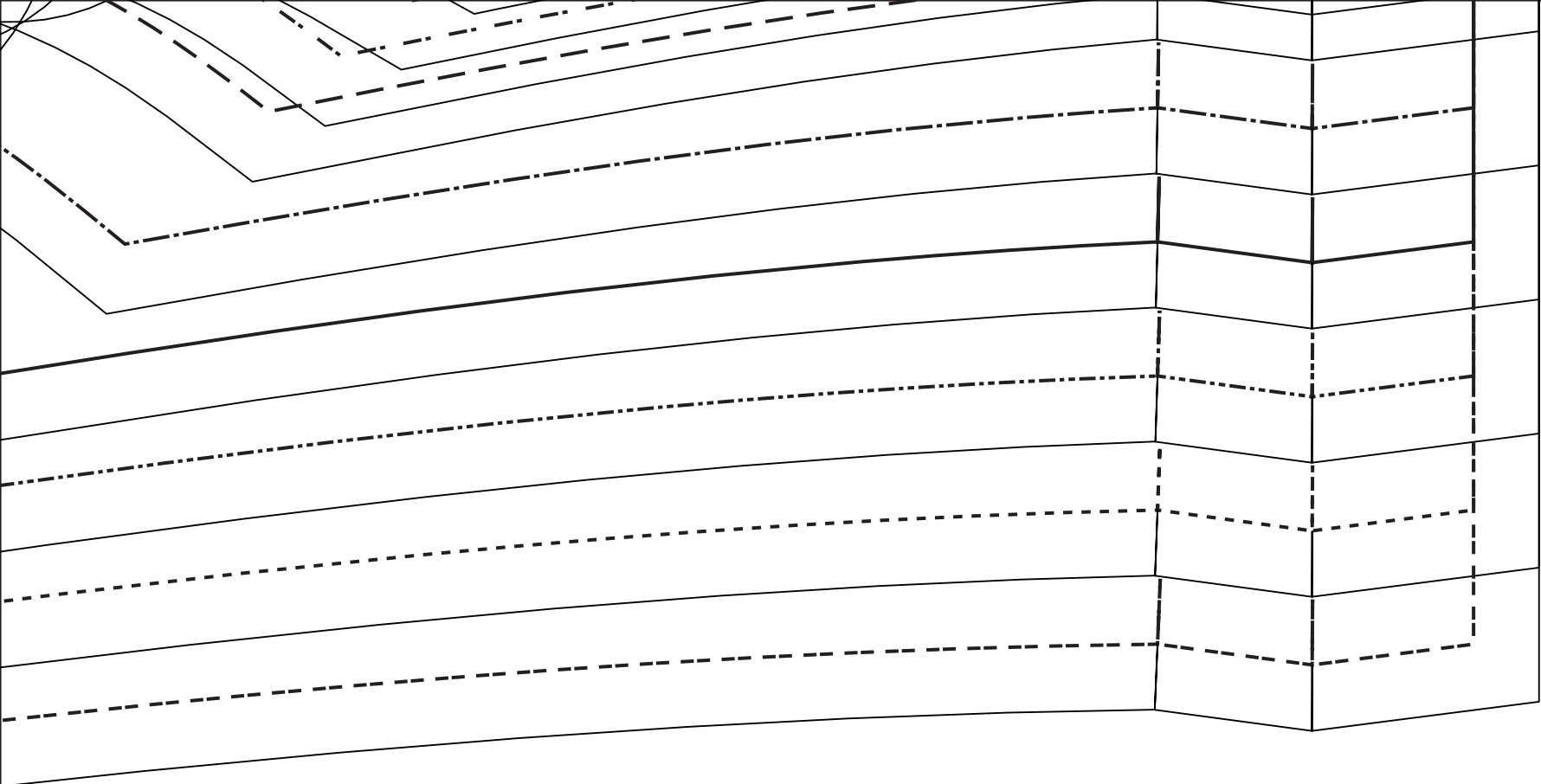

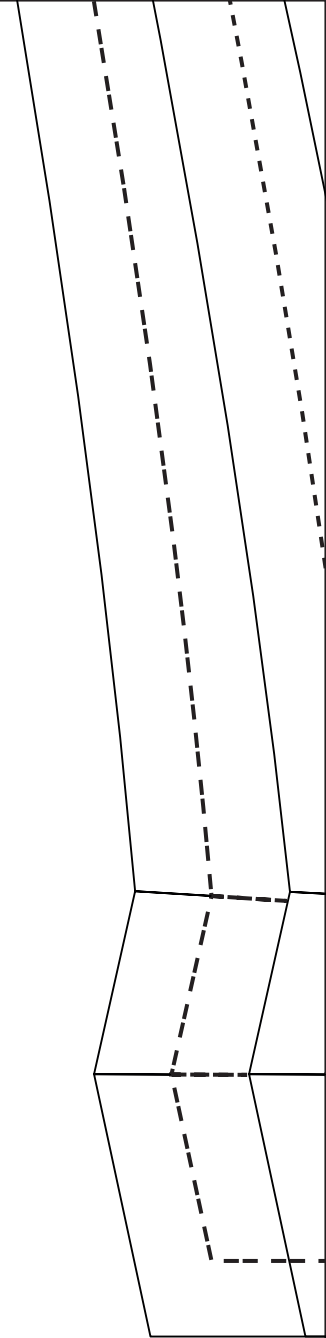
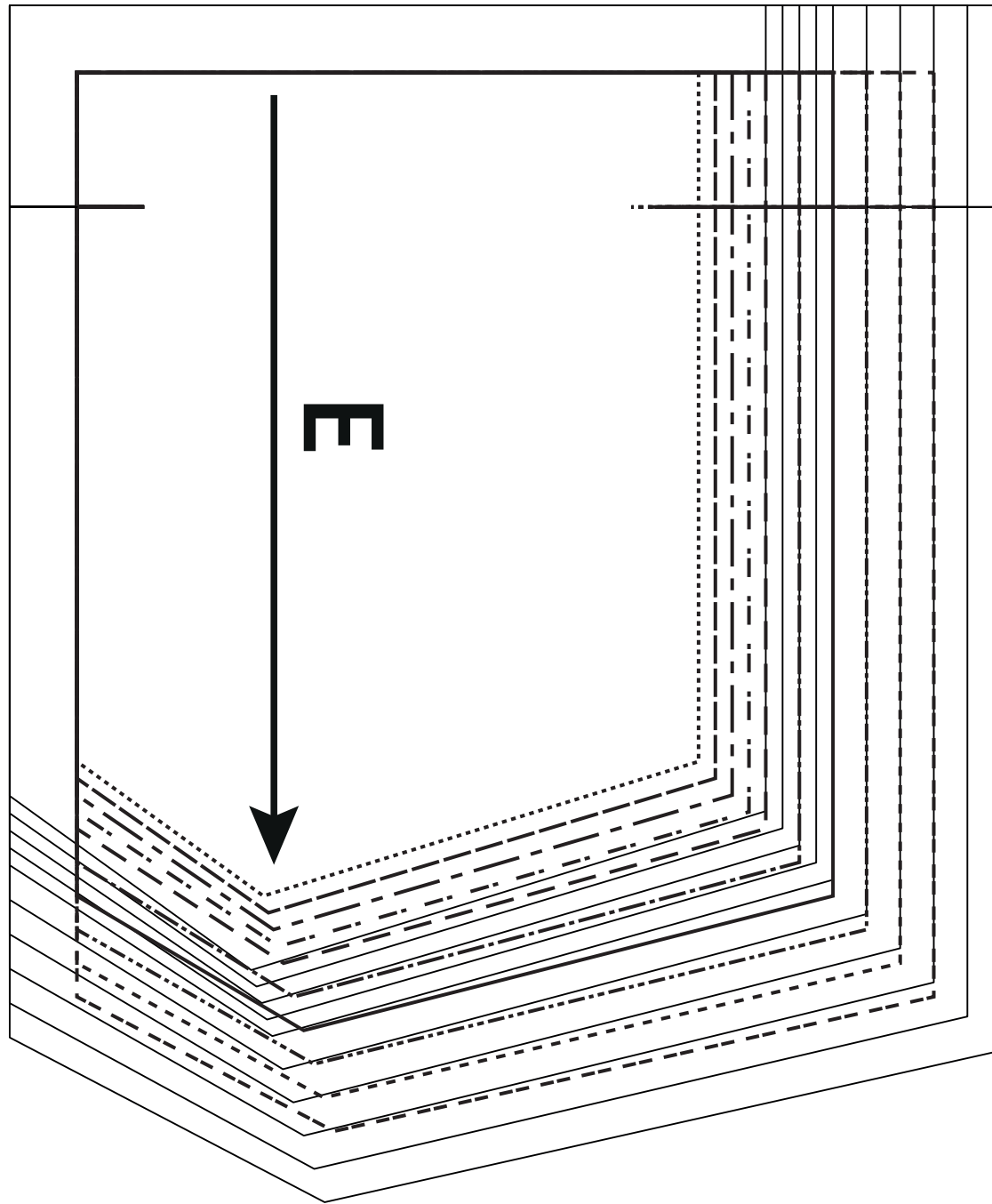

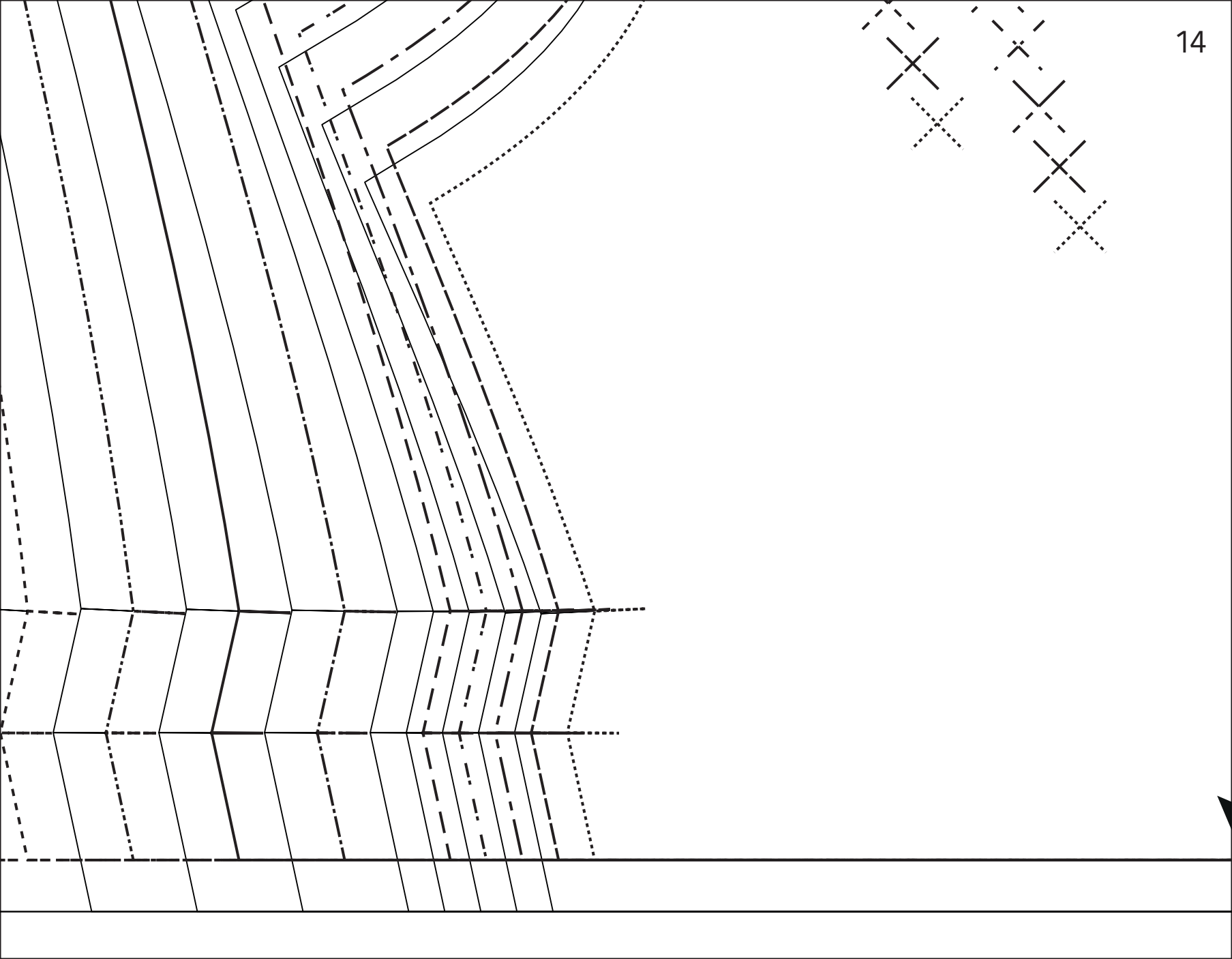

15



**B**

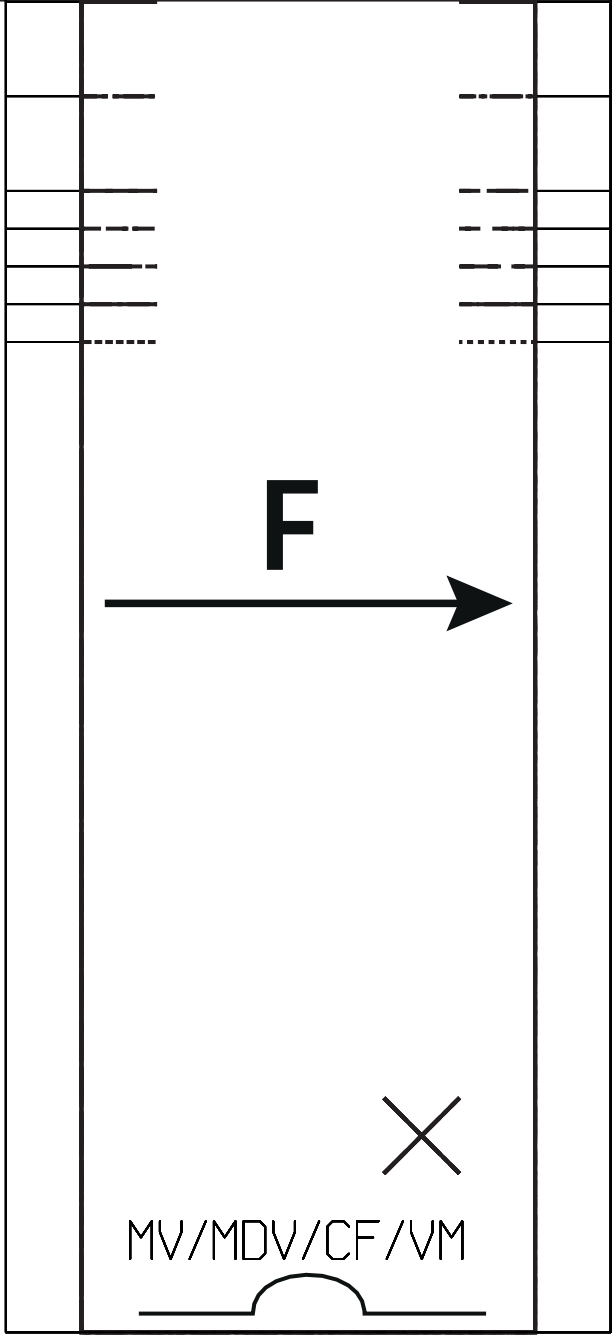
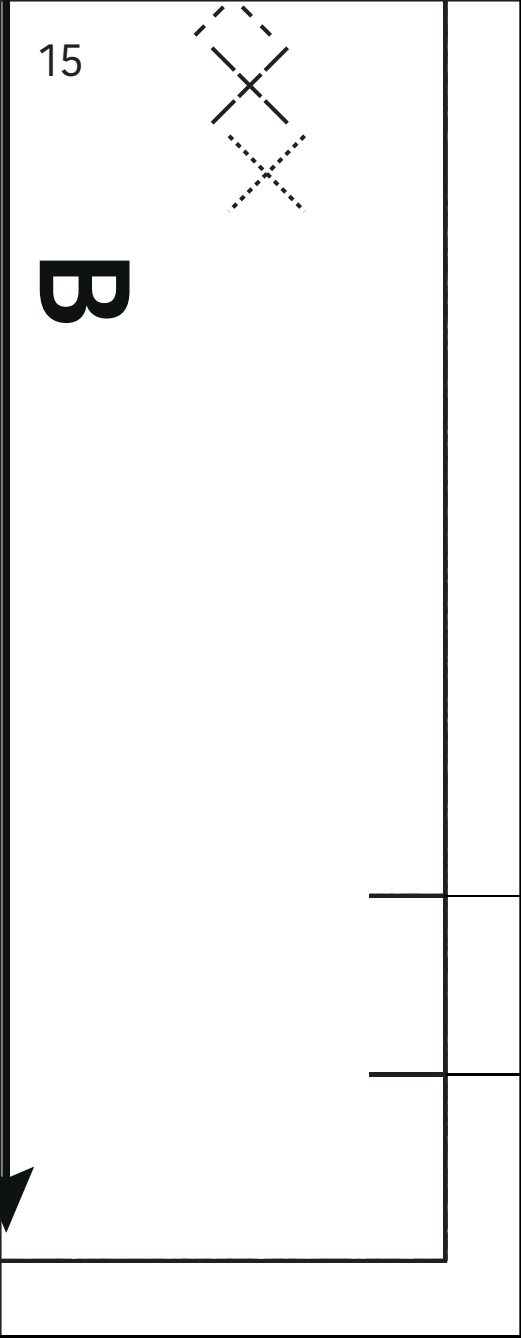

MV/MDV/CF/VM