

# Paula

## Jurk / Robe / Dress / Kleid

### Maten / Tailles / Sizes / Größen:

-----	34
- - - - -	36
-----	38
-----	40
-----	42
-----	44
-----	46
-----	48
-----	50
-----	52
-----	54
-----	56

### Patroondelen / Pièces du patron / Pattern pieces / Schnittteile:

- A** voorpand / devant / front panel /  
Vorderteil
- B** rugpand / dos / back panel /  
Rückenteil
- C** zak / poche / pocket / Tasche
- D** beleg VP / parementure DV /  
facing FP / Besatz VT
- E** beleg RP / parementure DS /  
facing BP / Besatz RT
- F** beleg zak / parementure poche /  
pocket facing / Besatz RT
- G** tunnel RP / tunnel DS / casing BP /  
Tunnel RT
- H** taillelint / ruban de la taille /  
waistline bow tie / Taillebenband

## Patroonschema / Schéma du Patron / Pattern Diagram / Übersichtsplan zum Zusammenkleben

1	2	3	4	5	6	7
8	9	10	11	12	13	14
15	16	17	18	19	20	21
22	23	24	25	26	27	28
29	30	31	32	33	34	35
36	<del>37</del>	<del>38</del>	<del>39</del>	<del>40</del>	<del>41</del>	<del>42</del>
43						

### Controlevierkant / Carré de controle / Test square / Kontrollquadrat

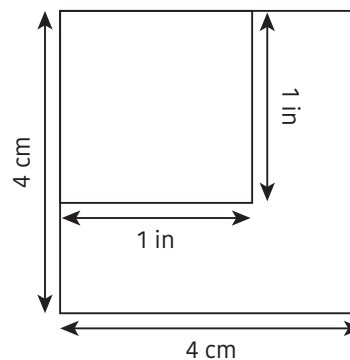

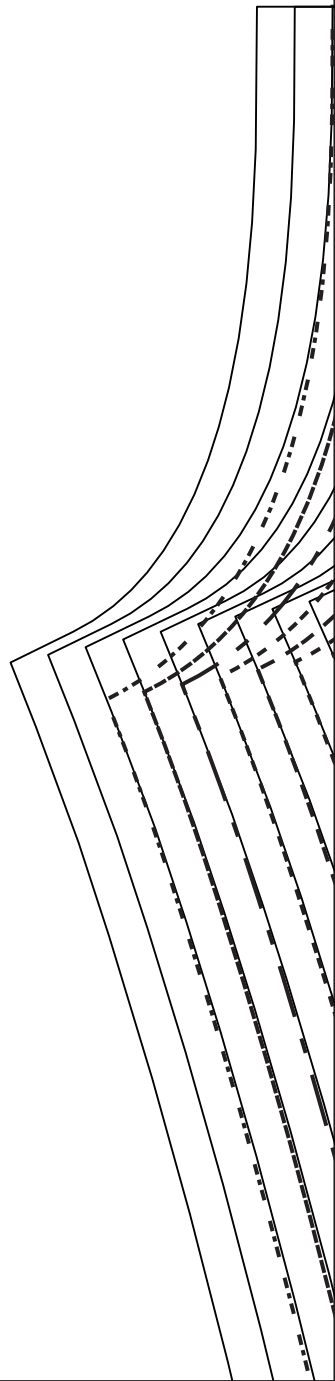
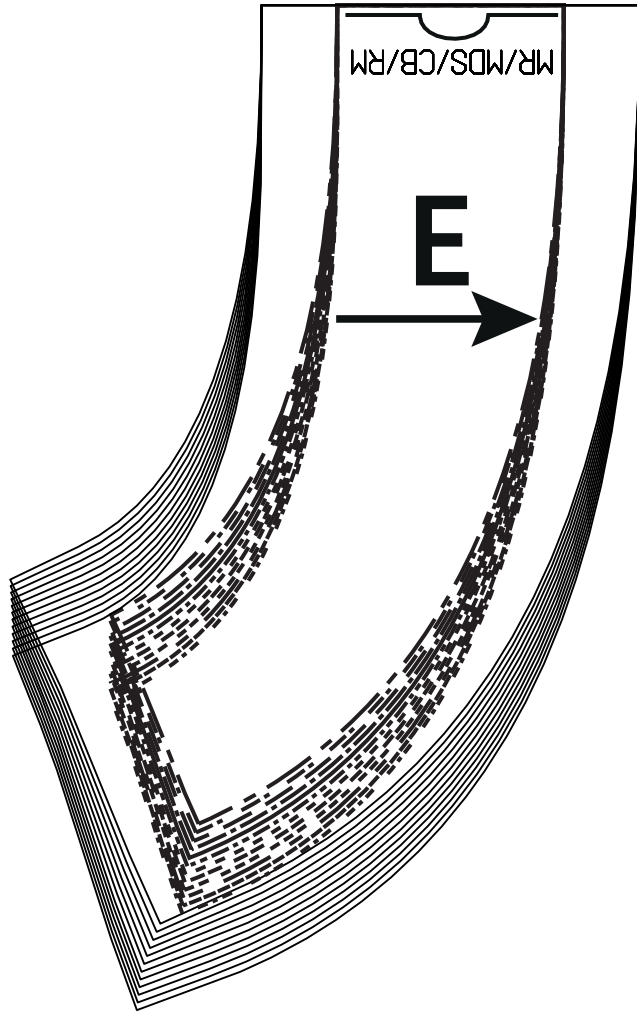

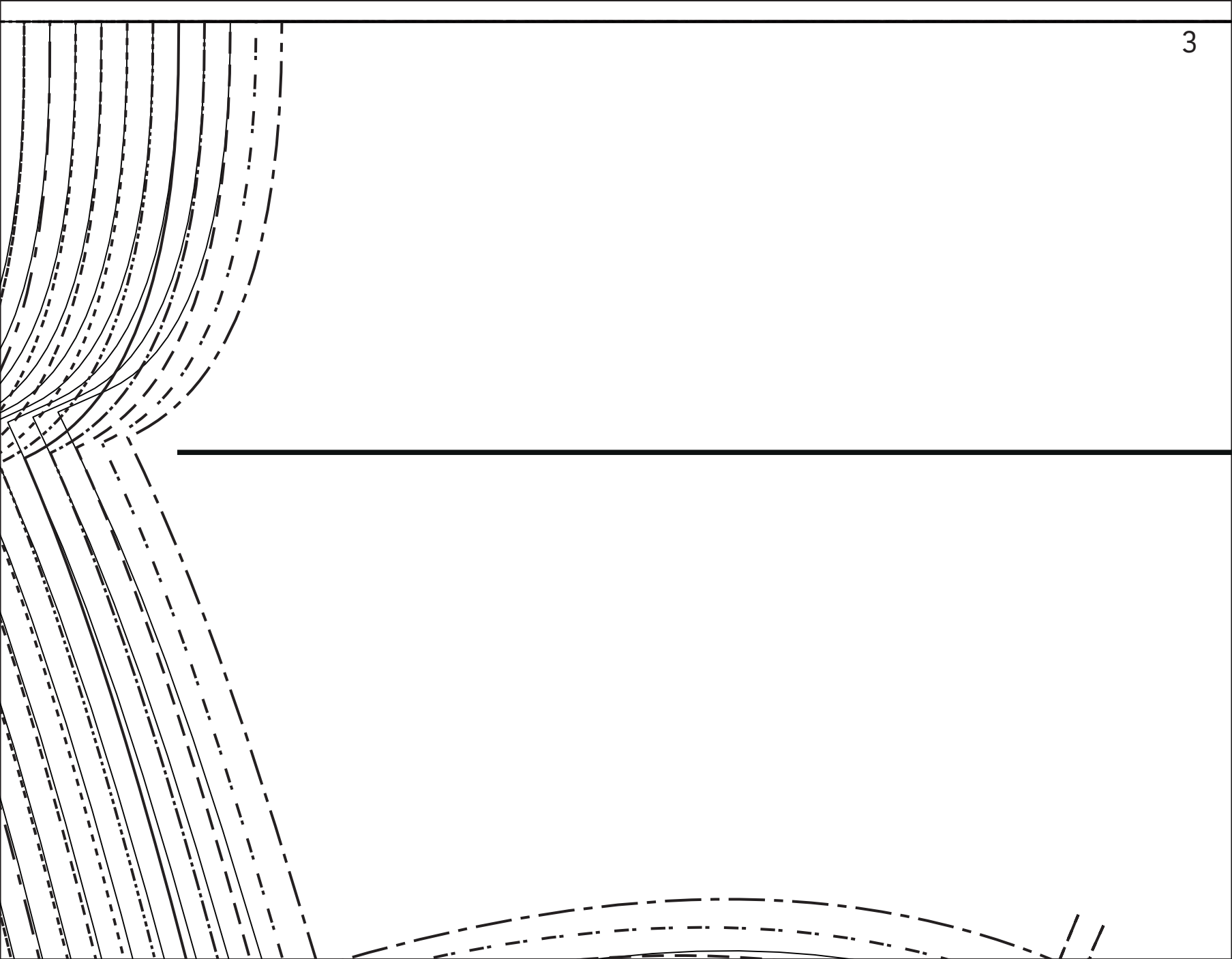





**B**





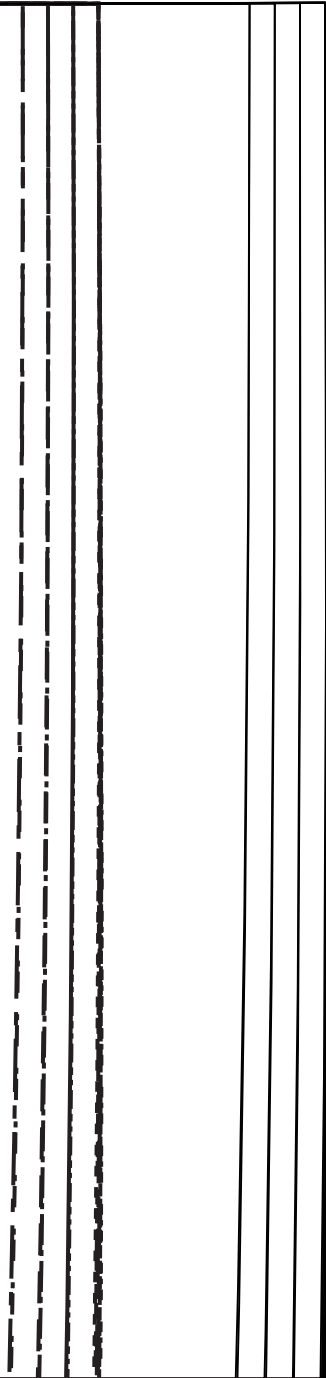

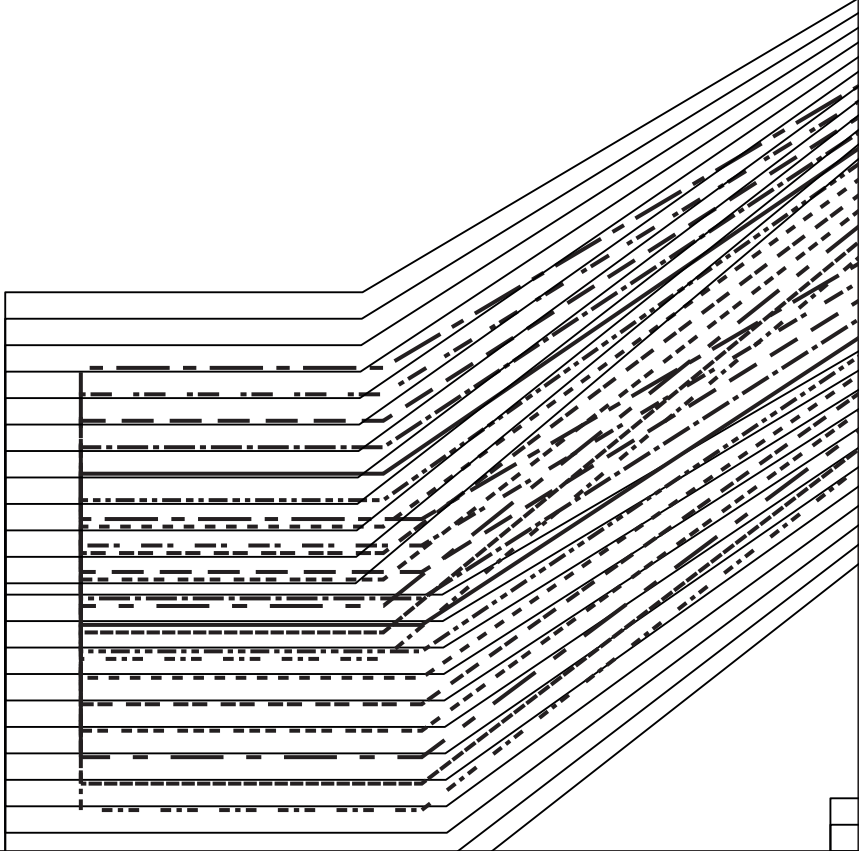
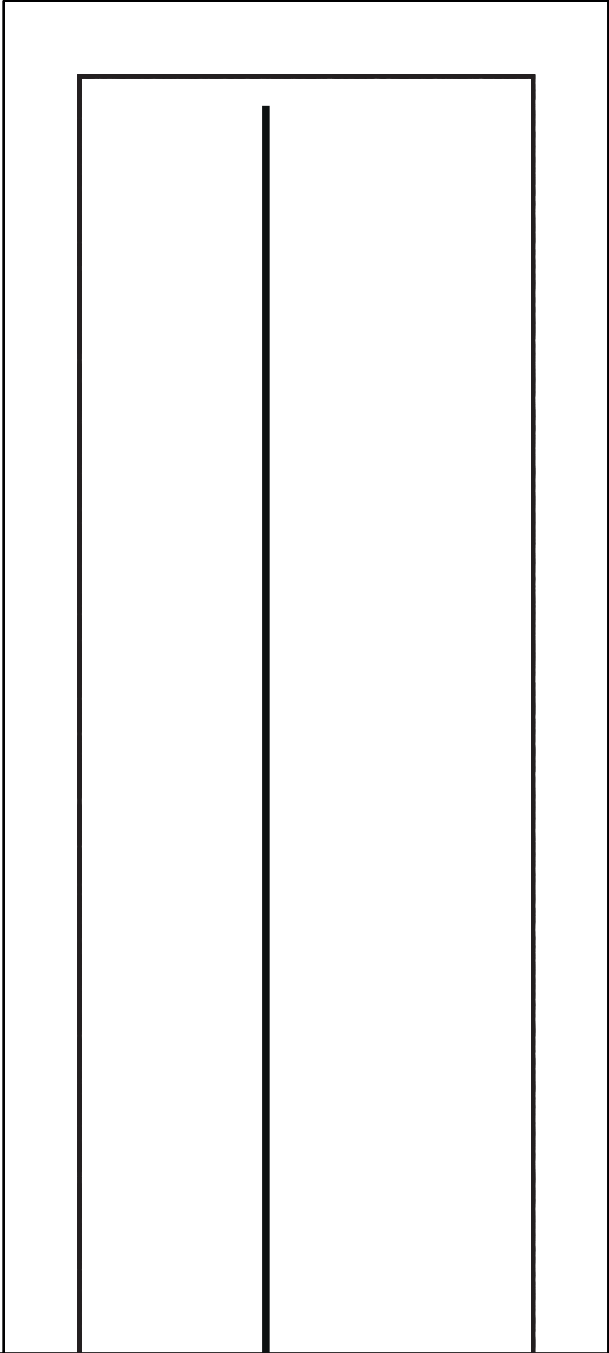



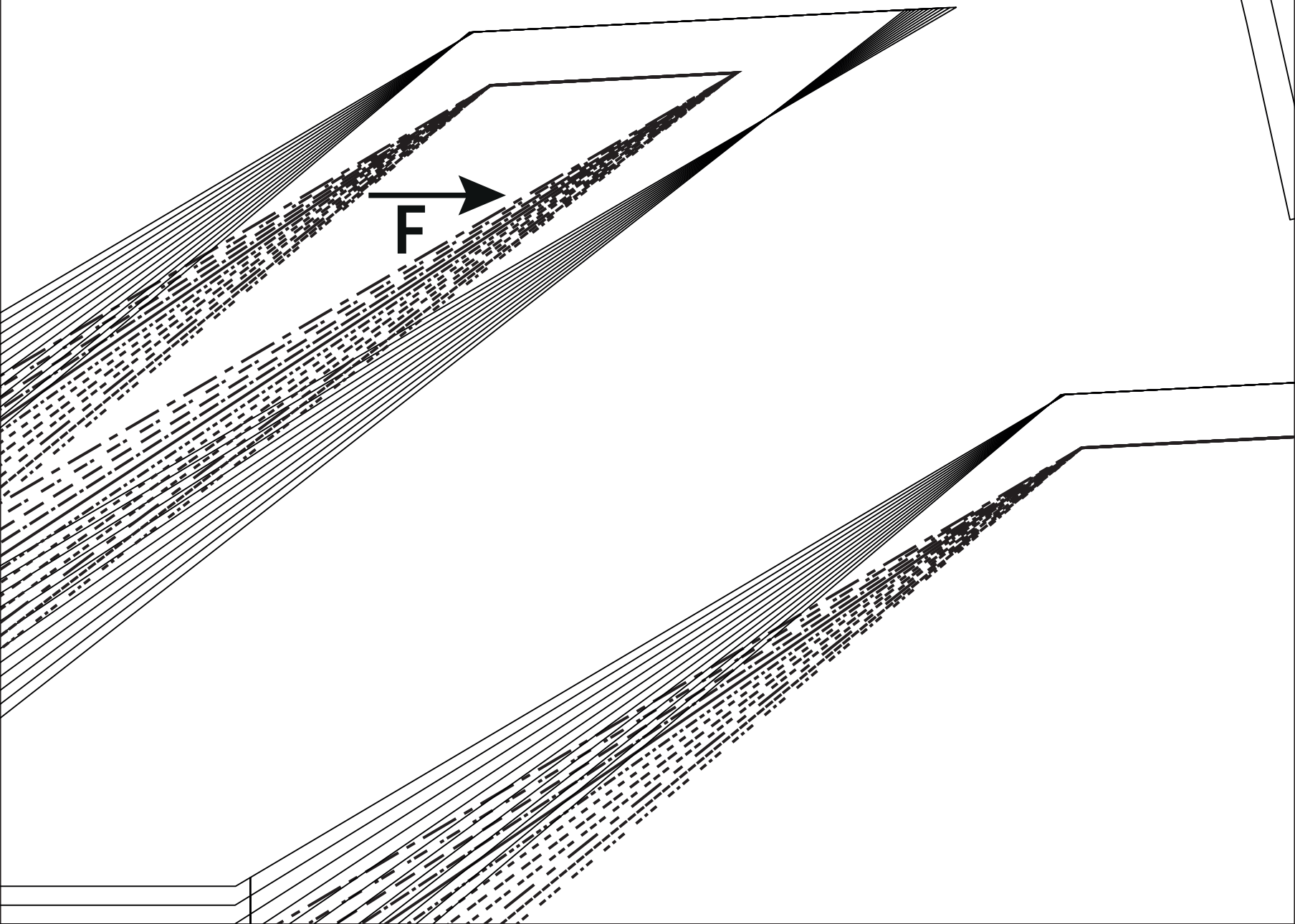

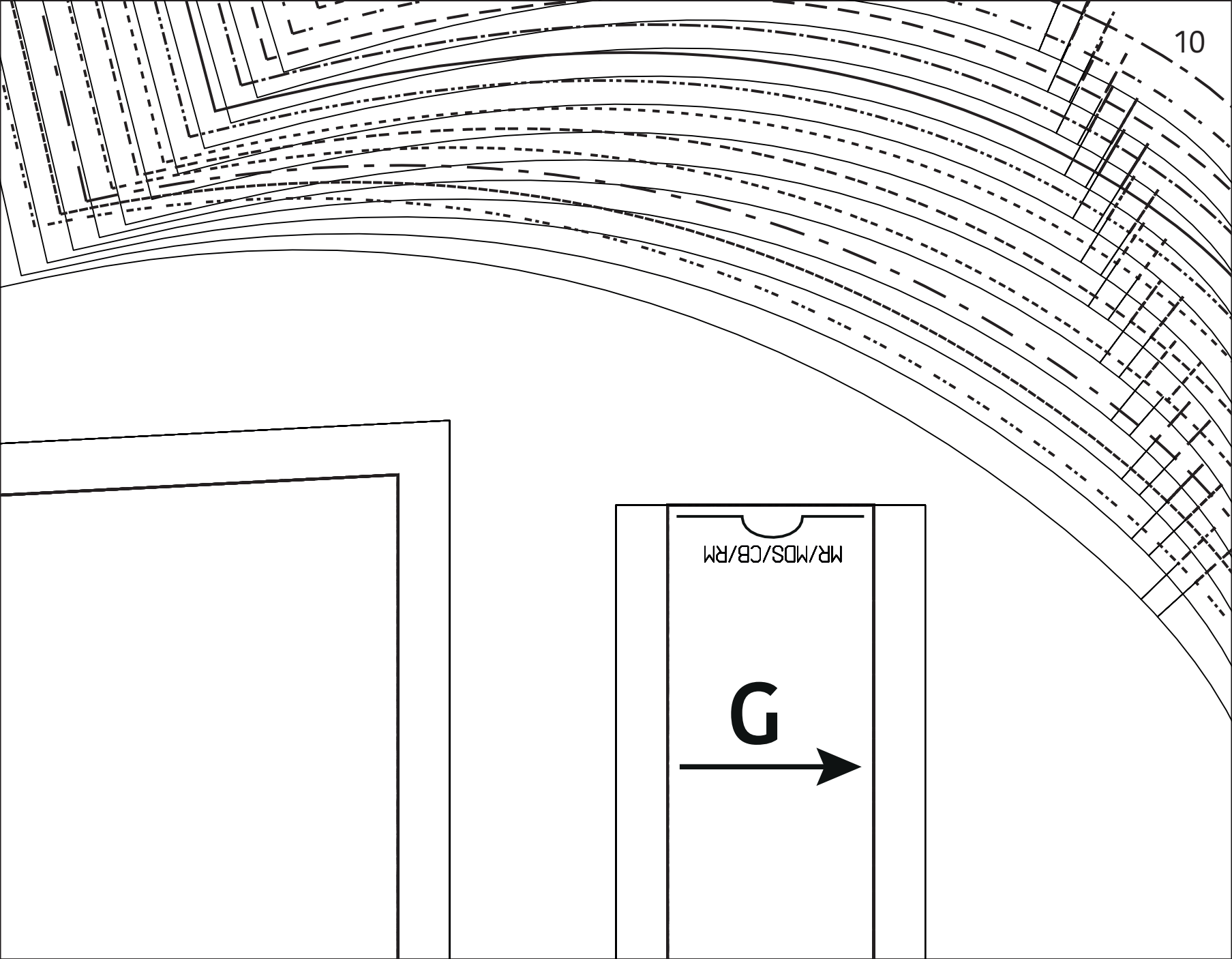

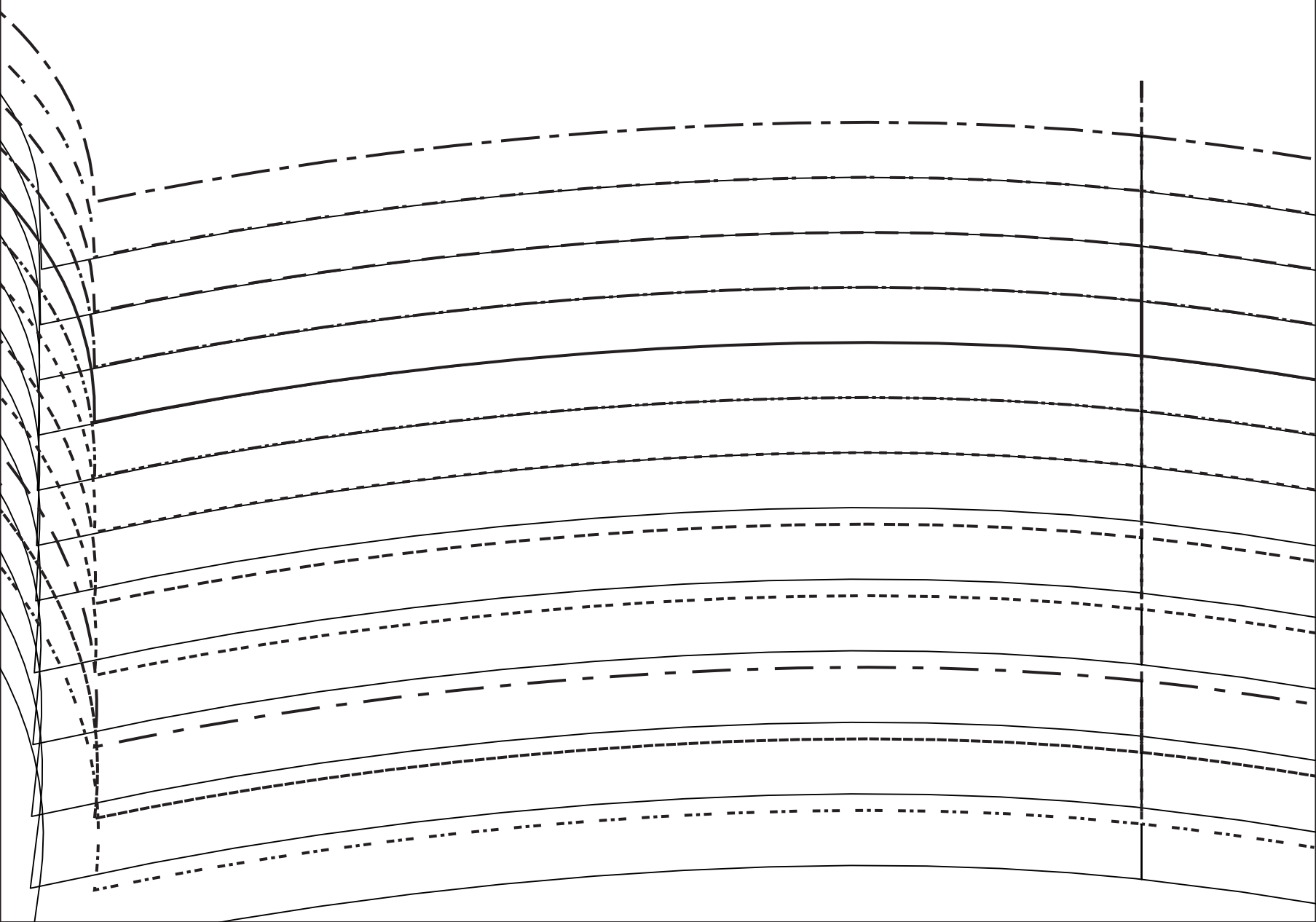

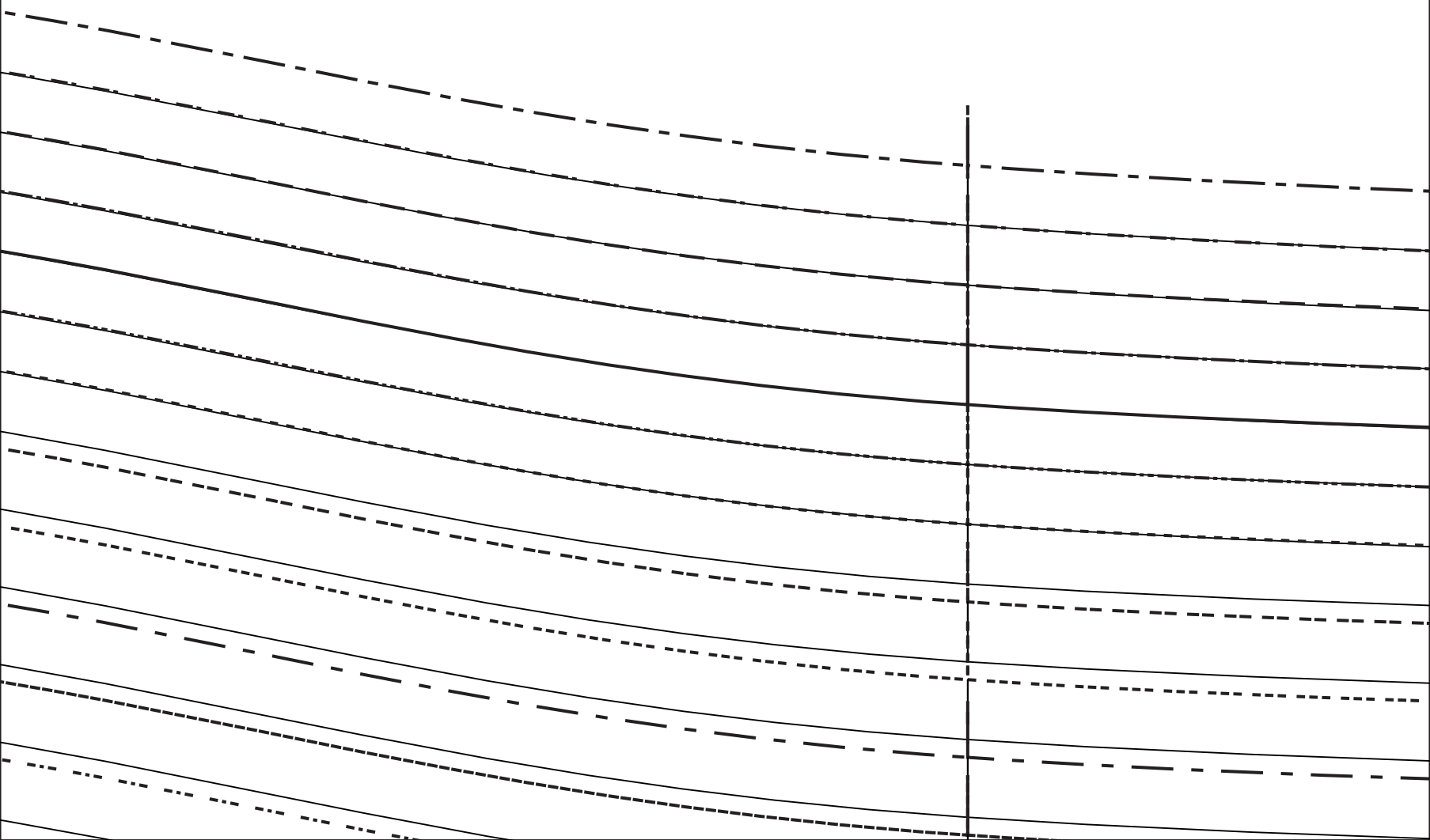

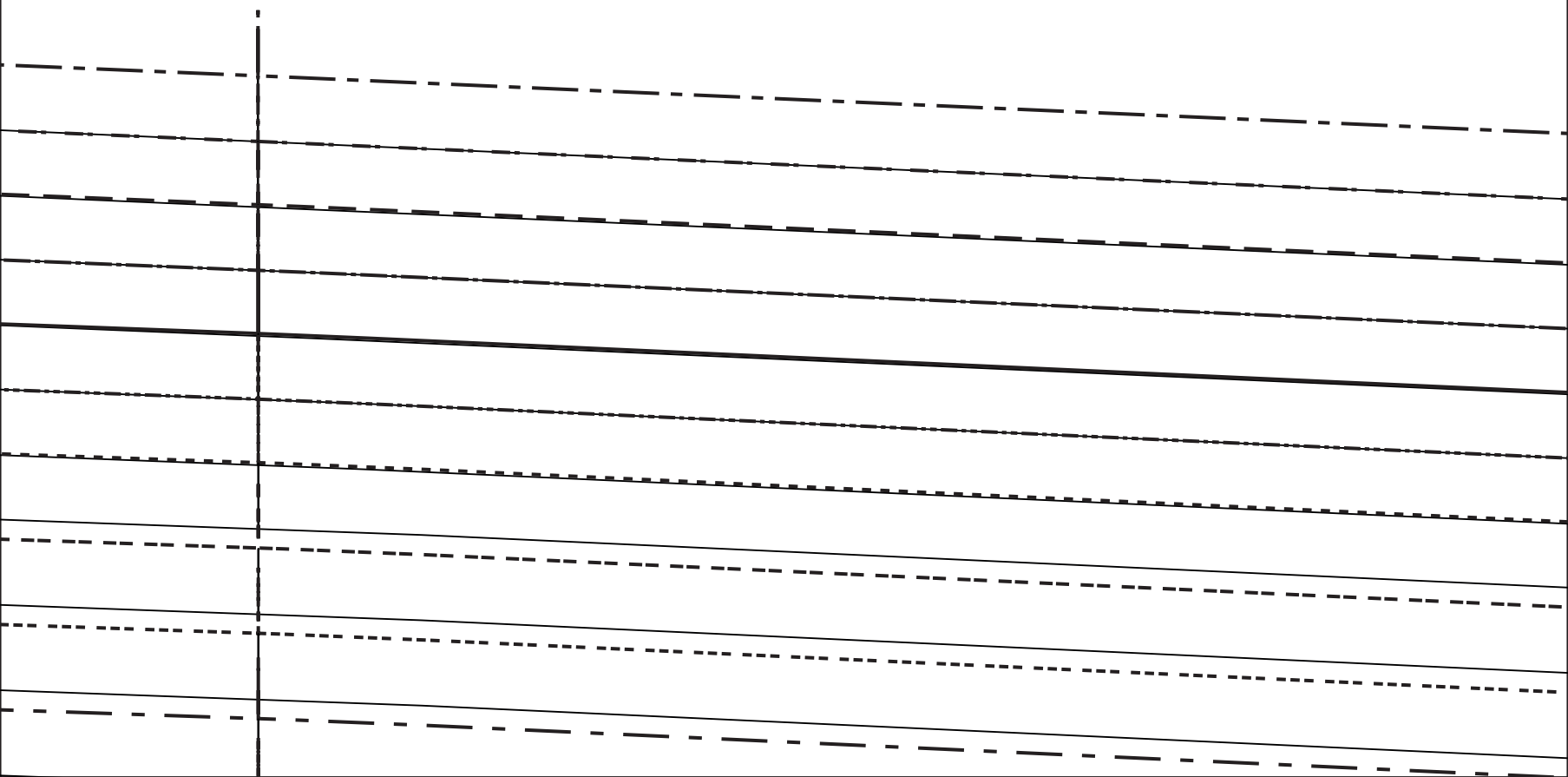

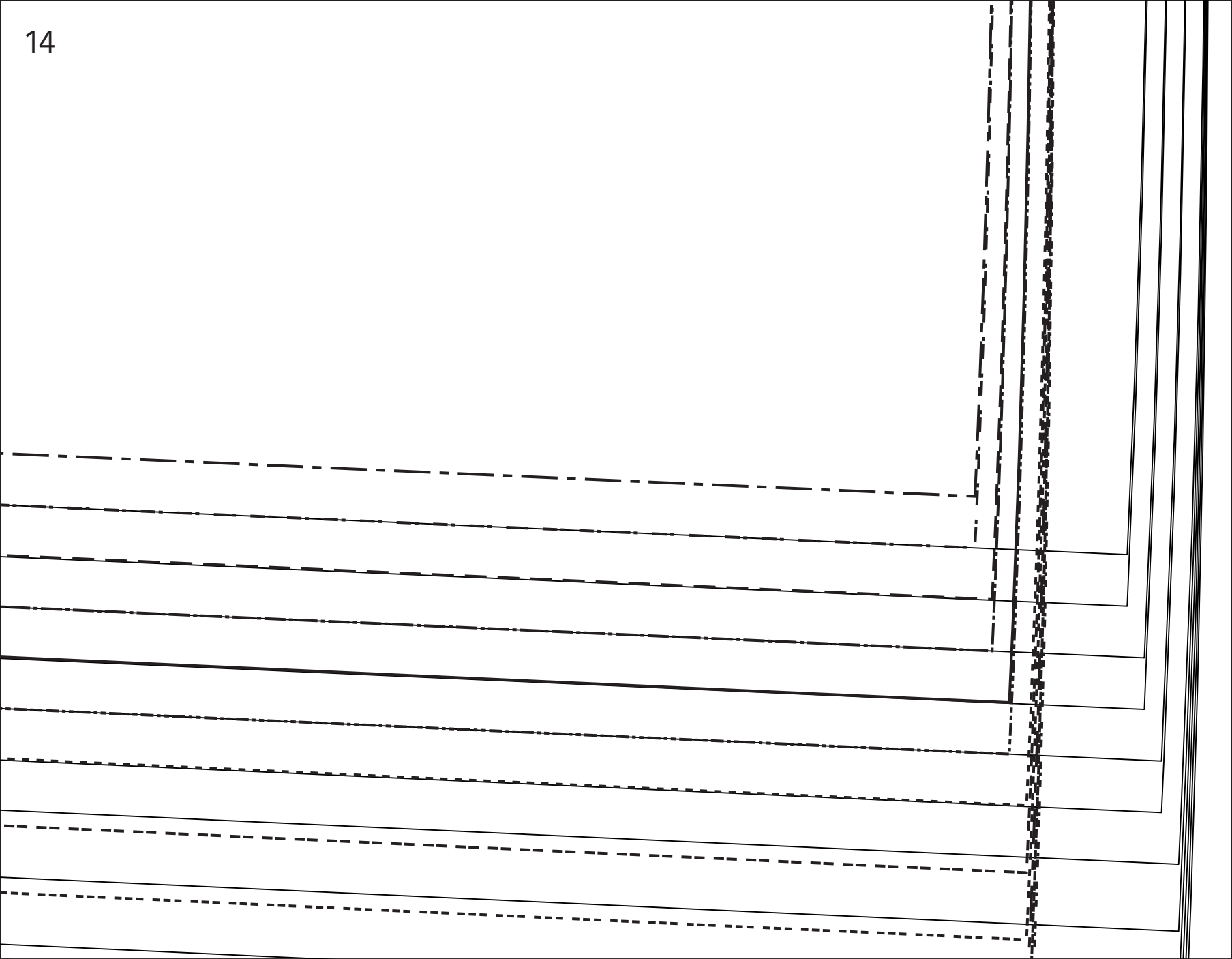

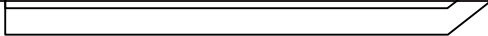

C

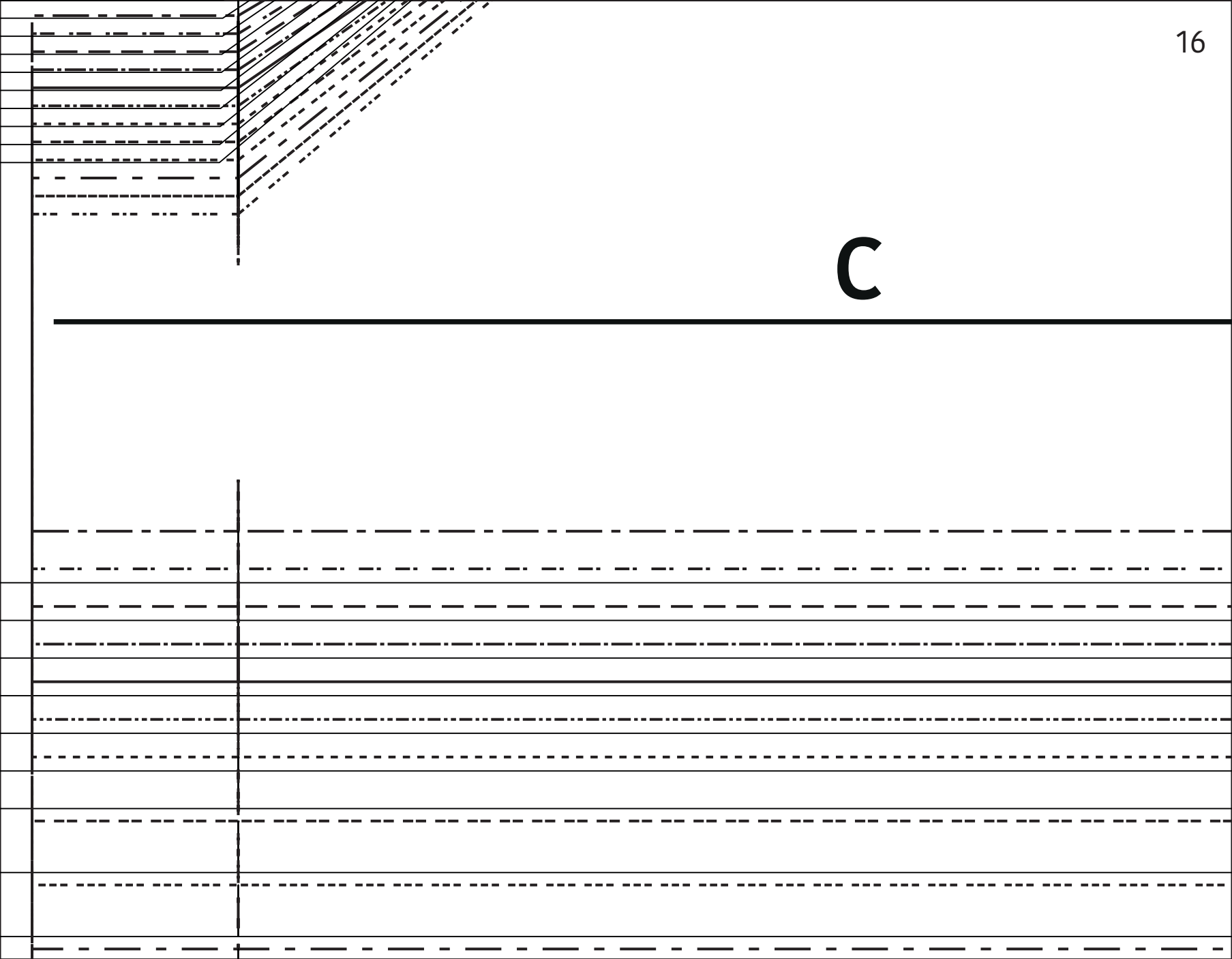



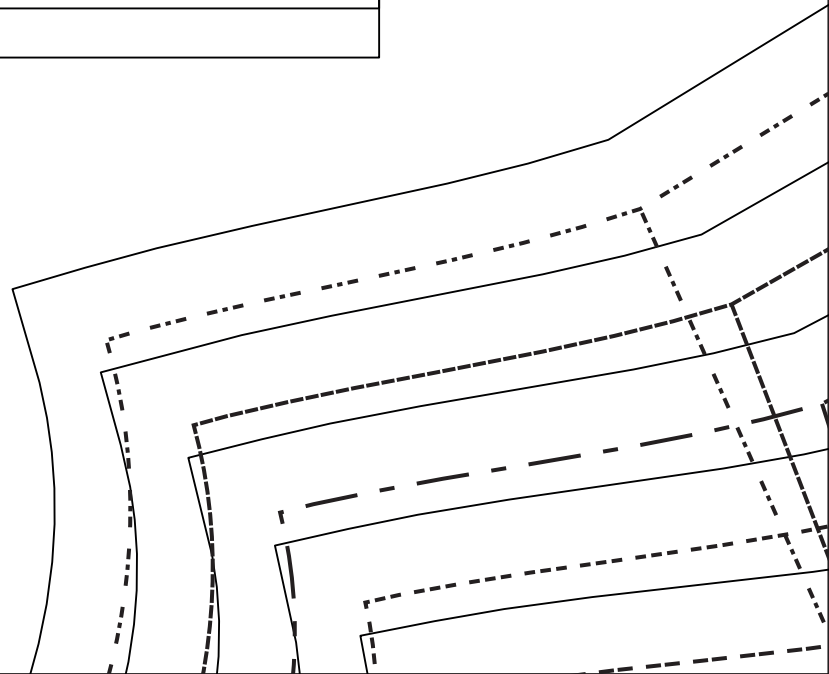
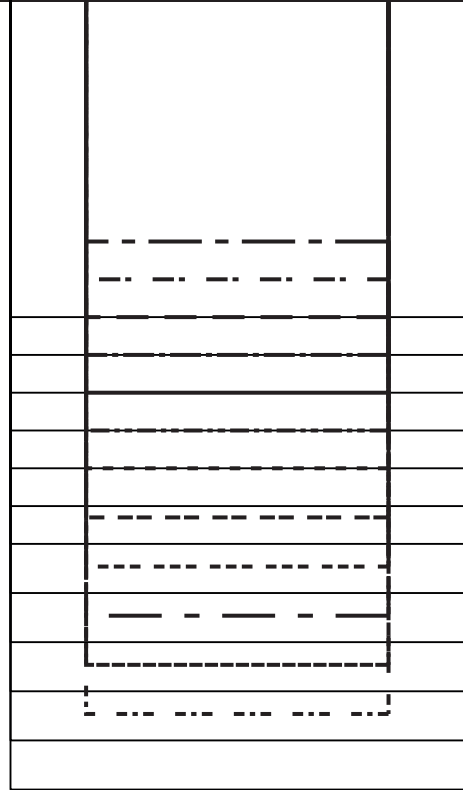
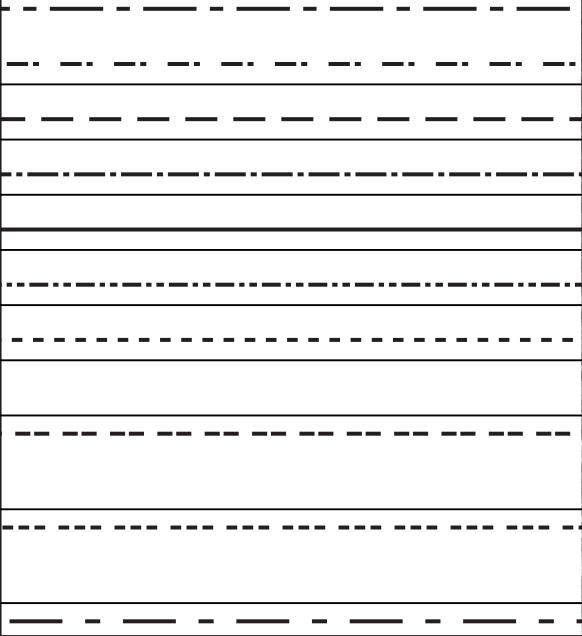

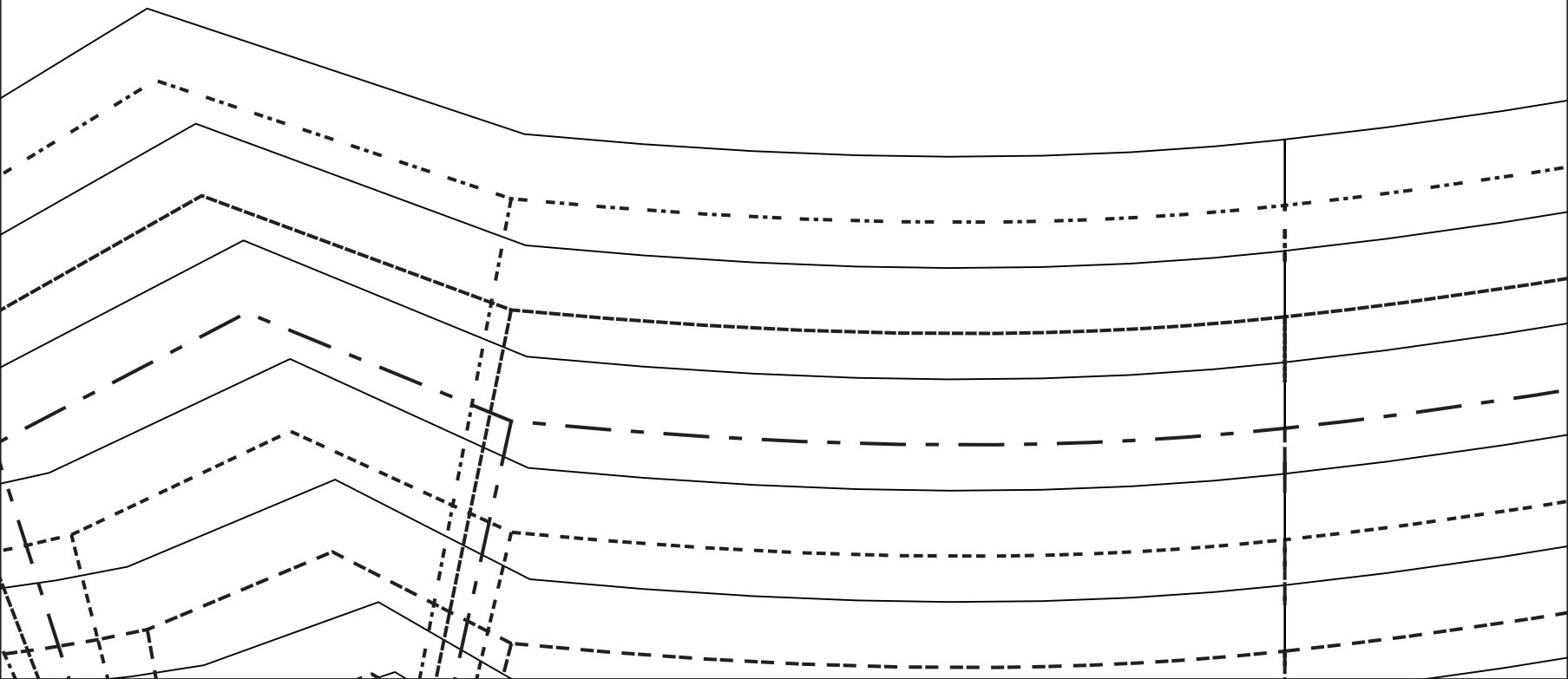

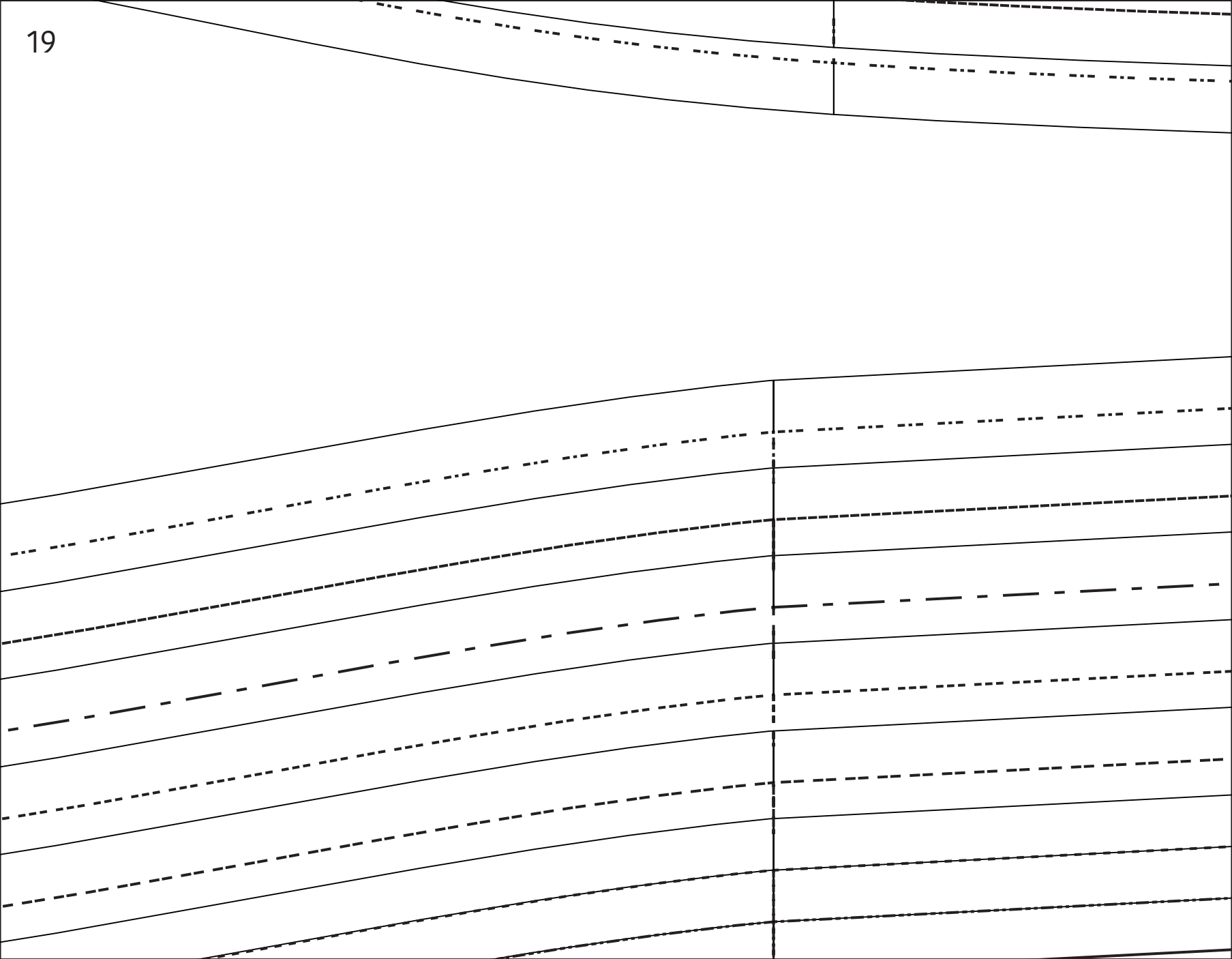

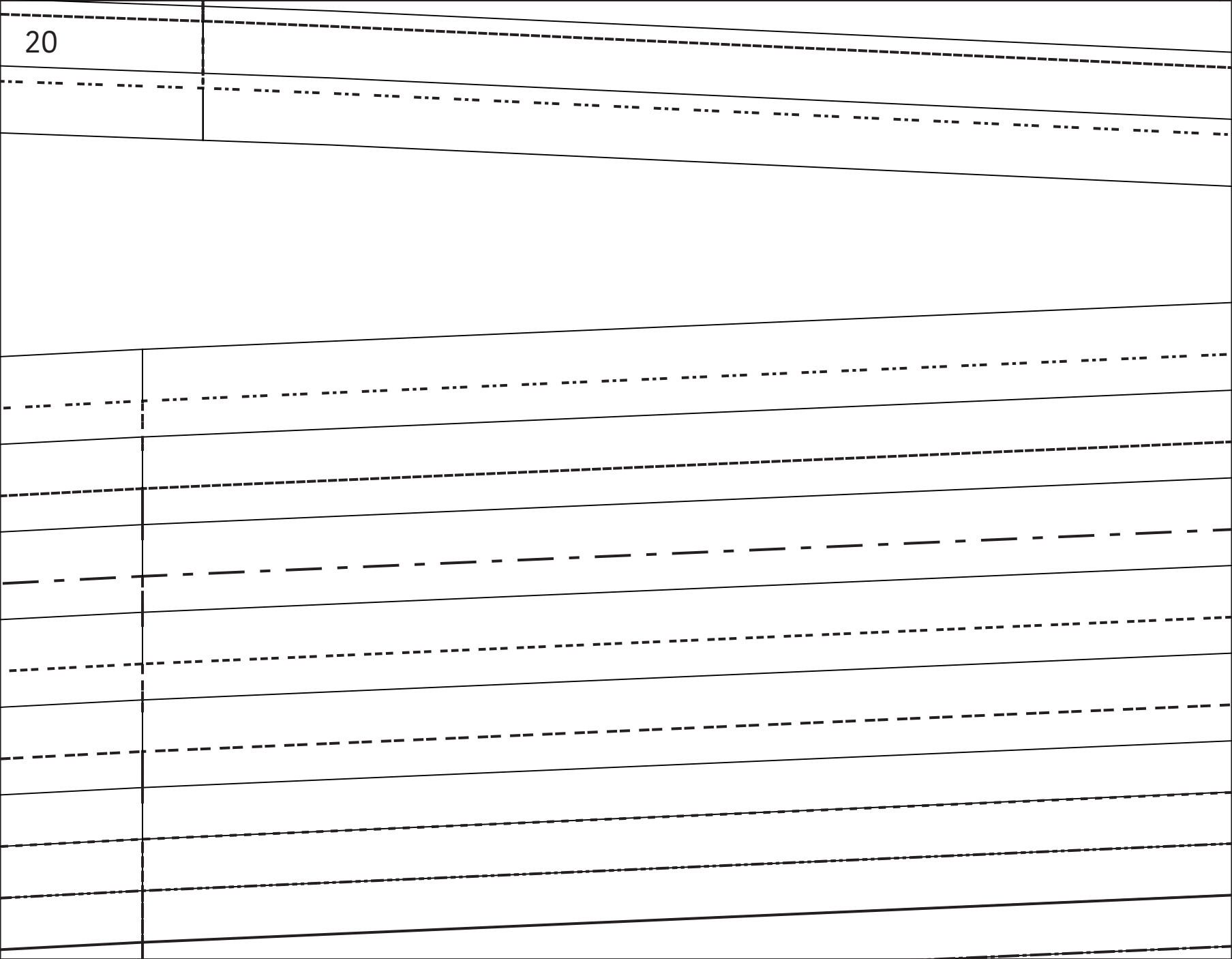

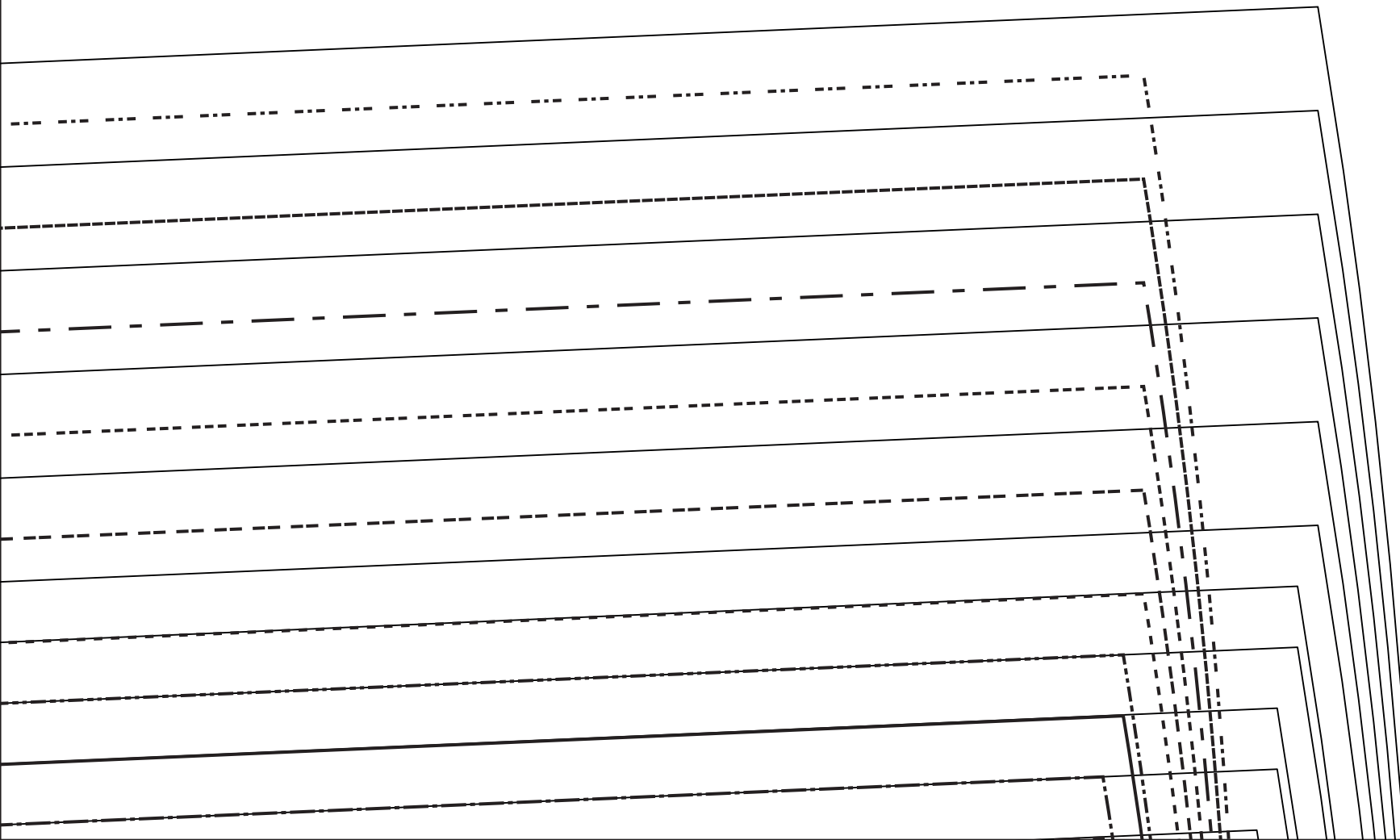
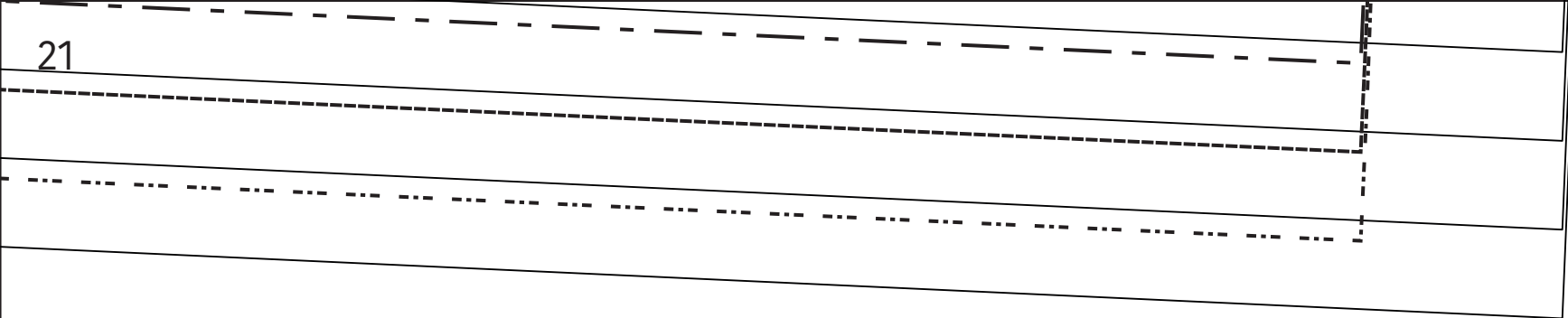

**H**

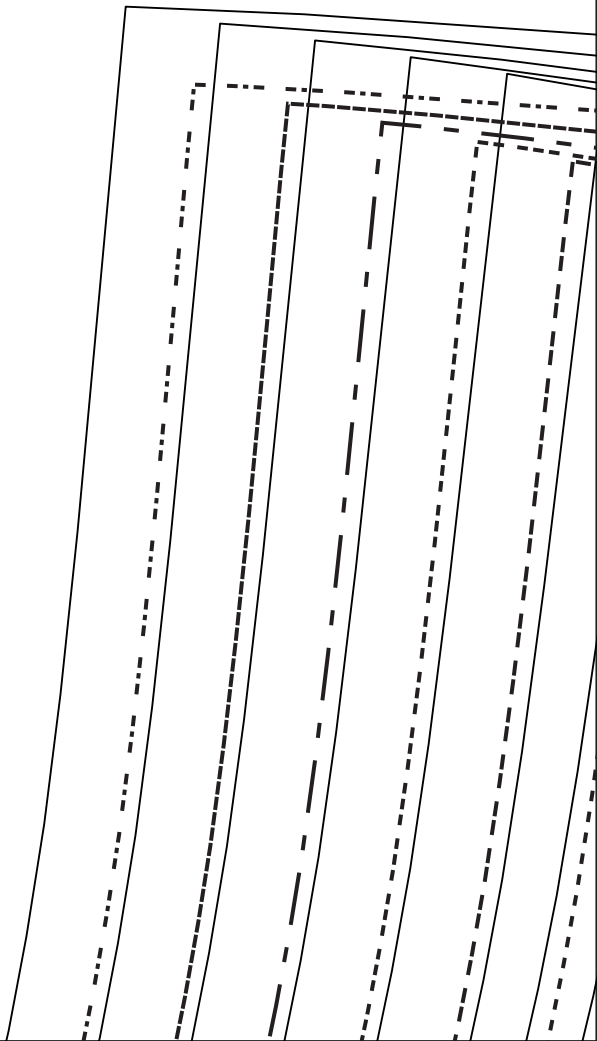

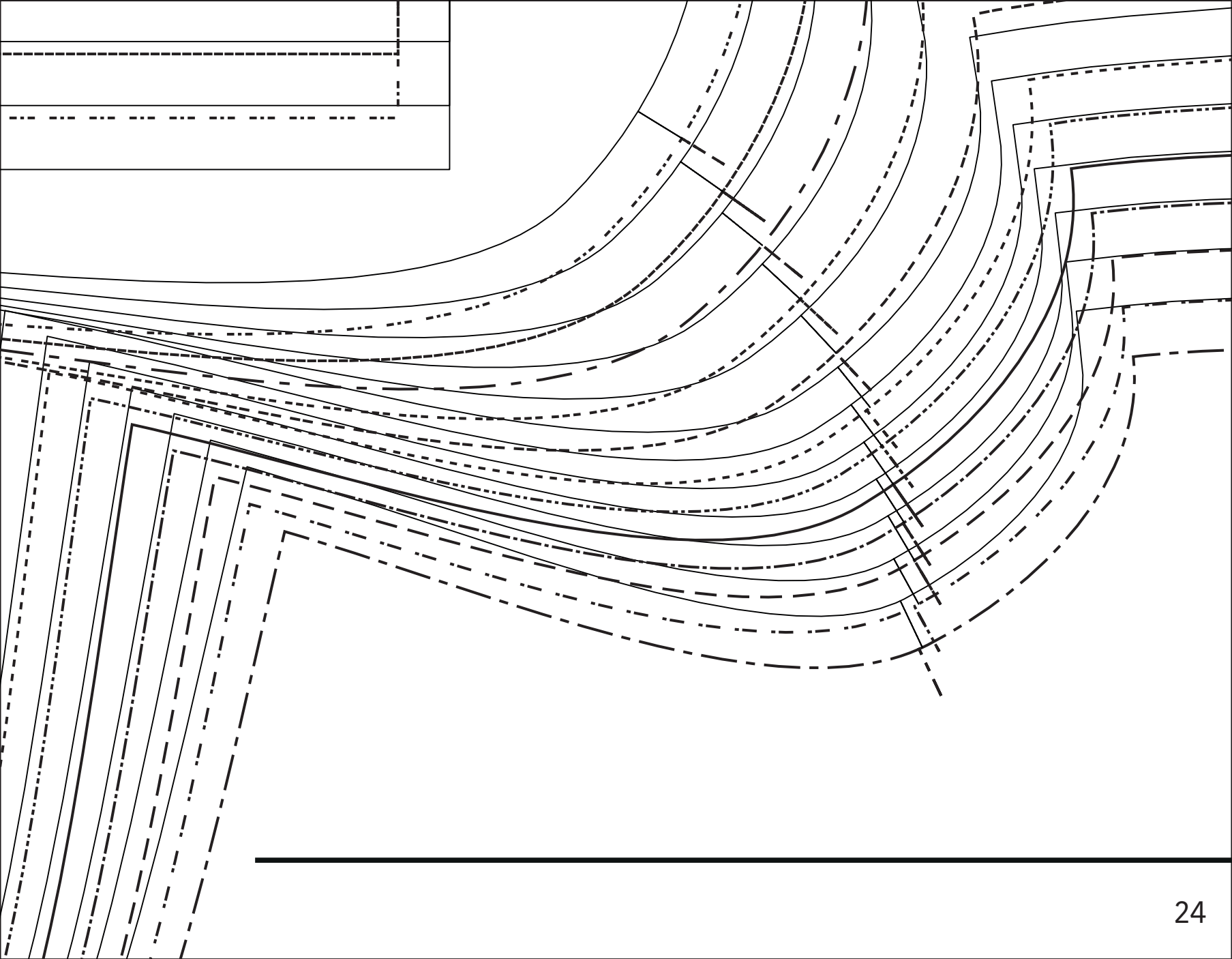



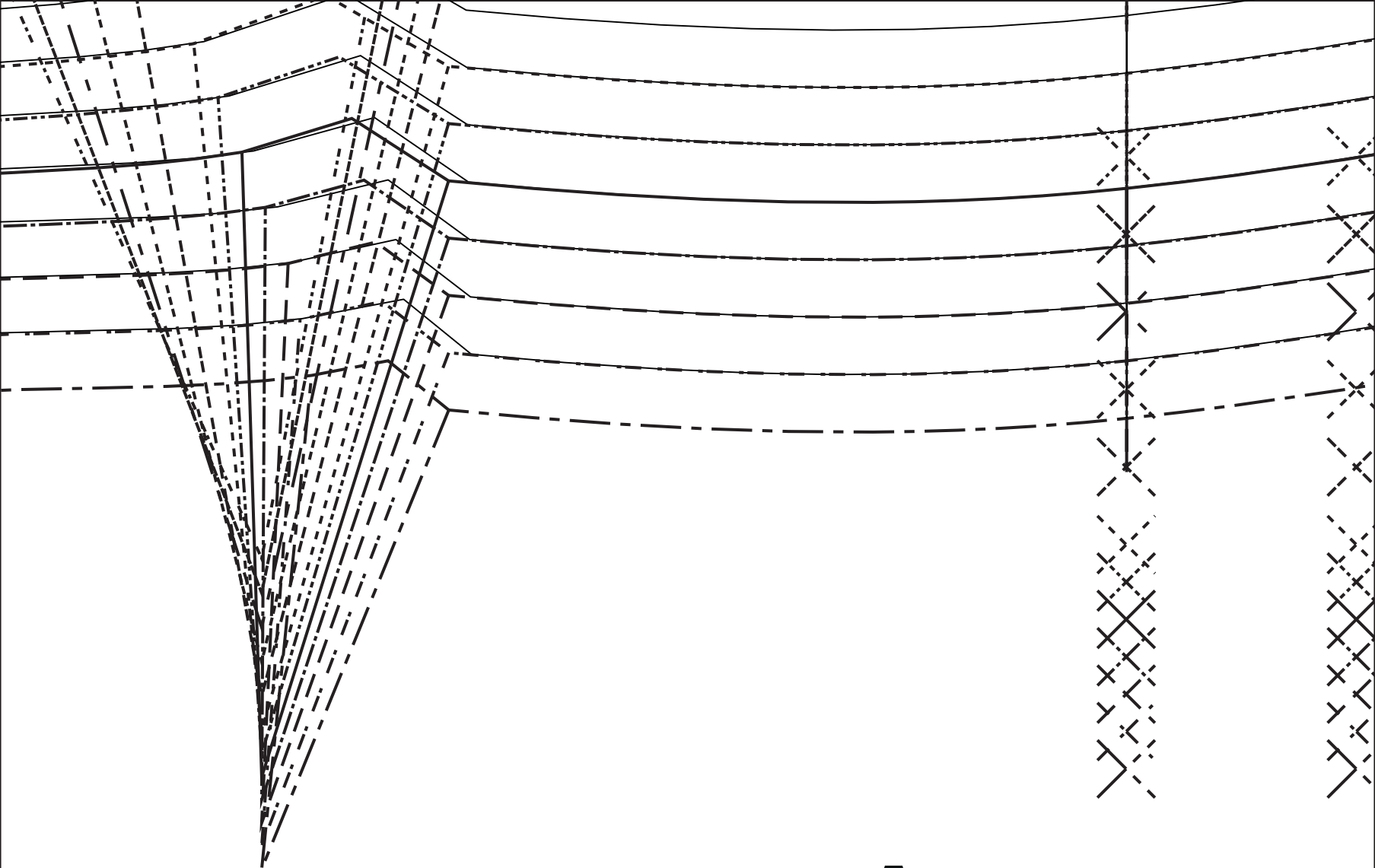

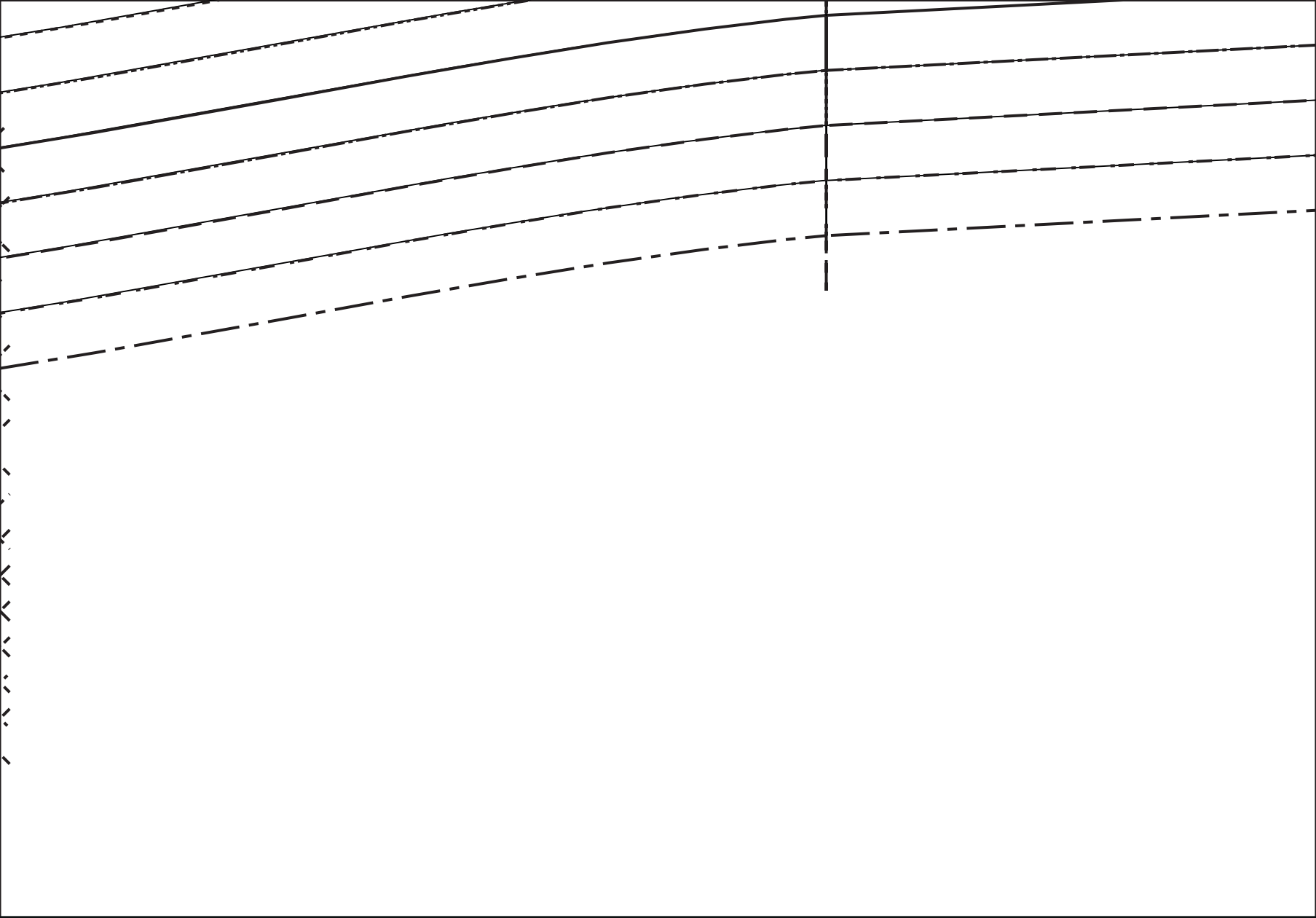

**A**



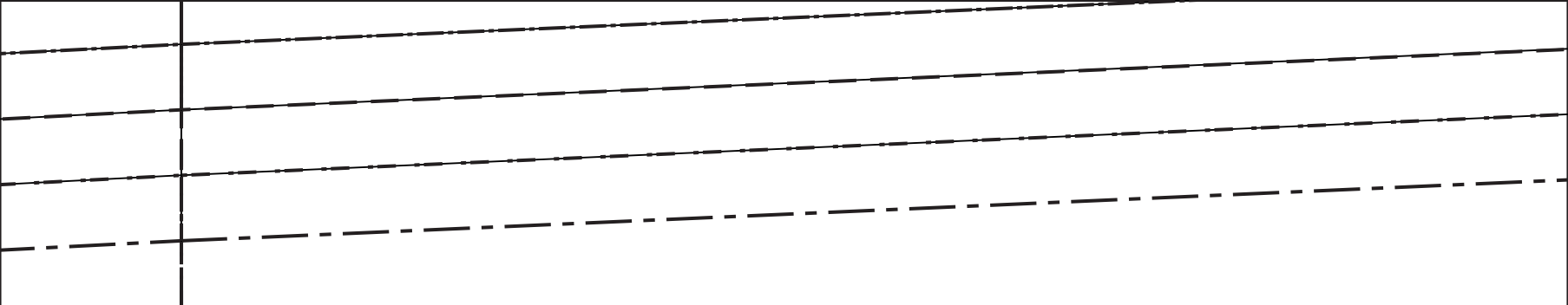

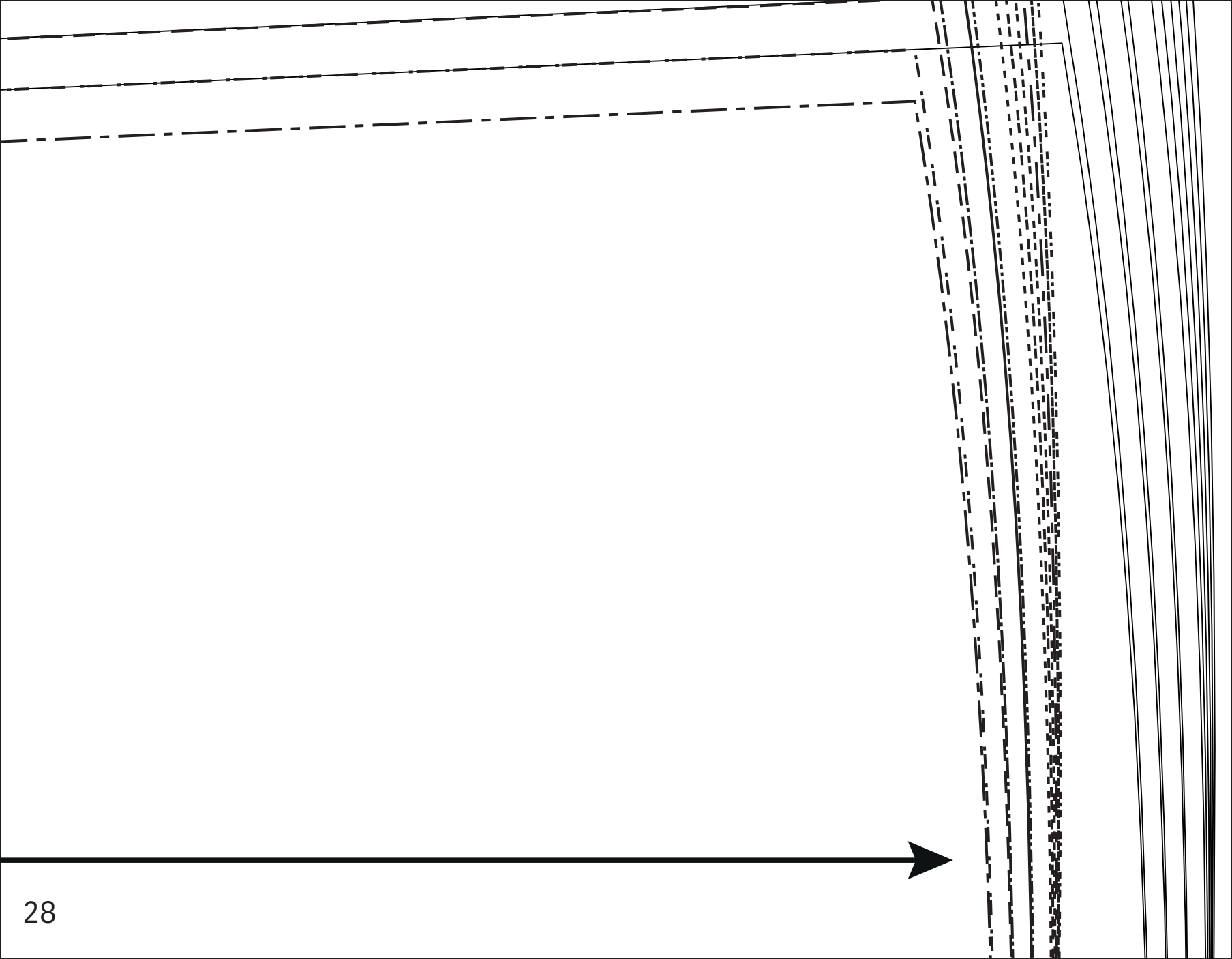

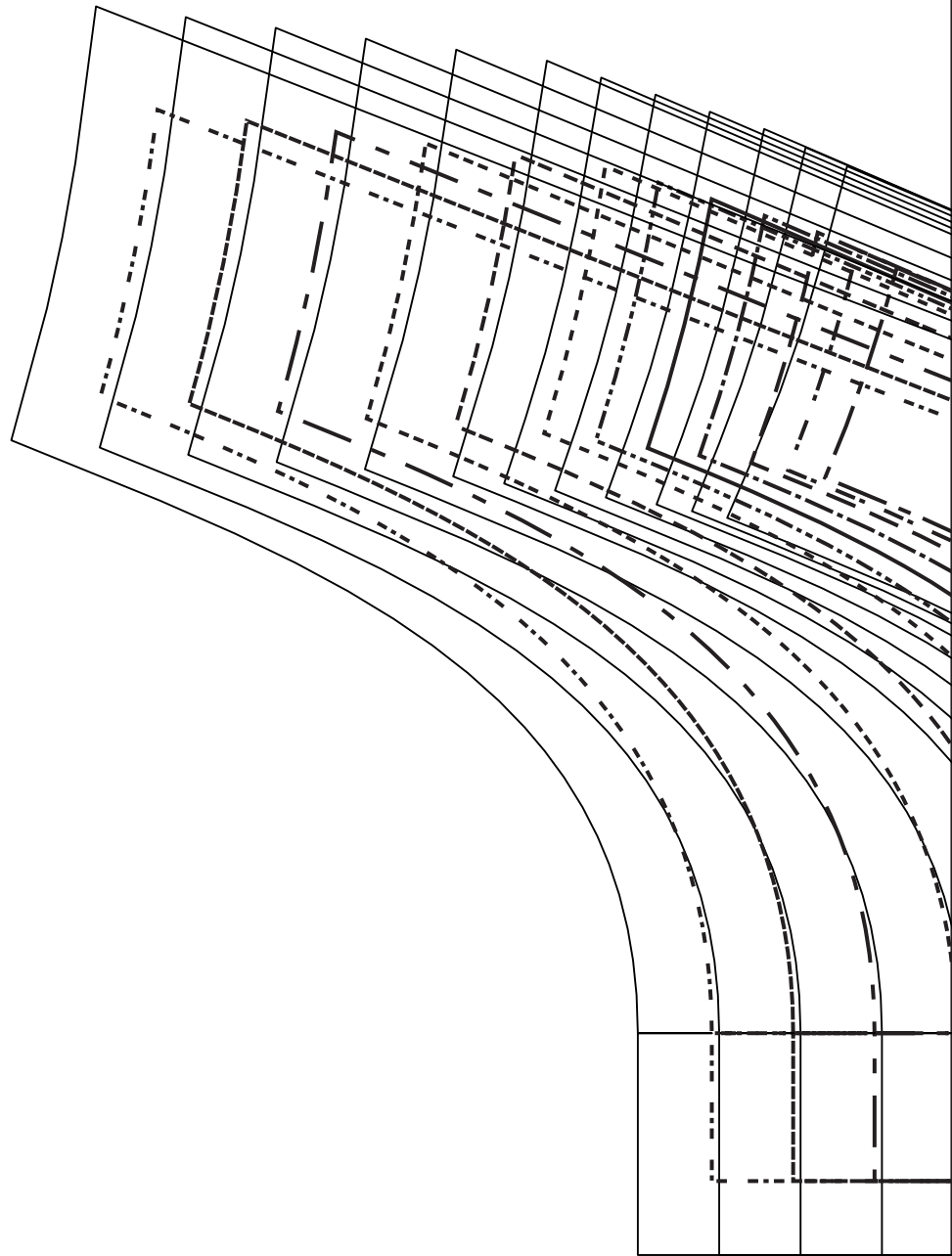

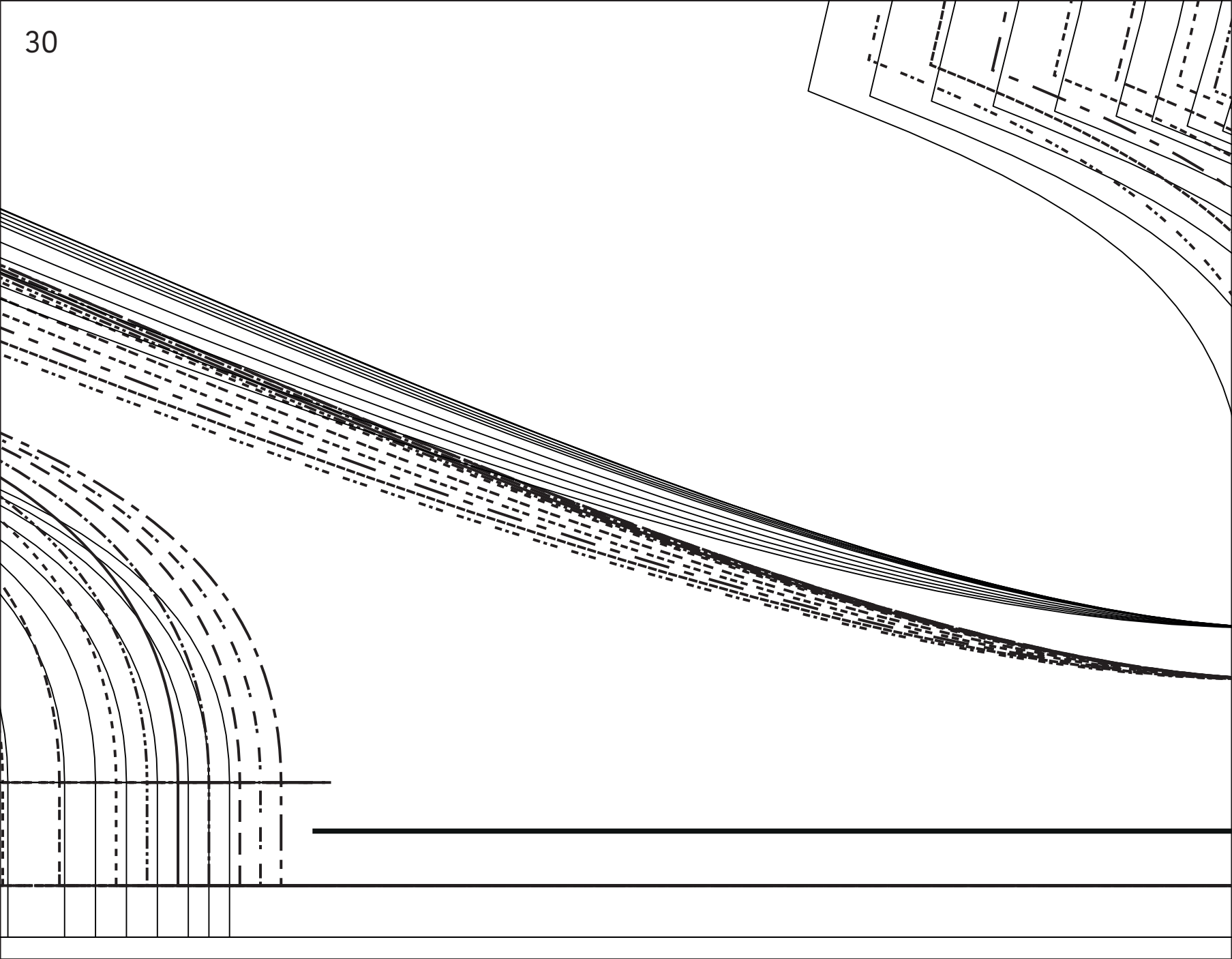

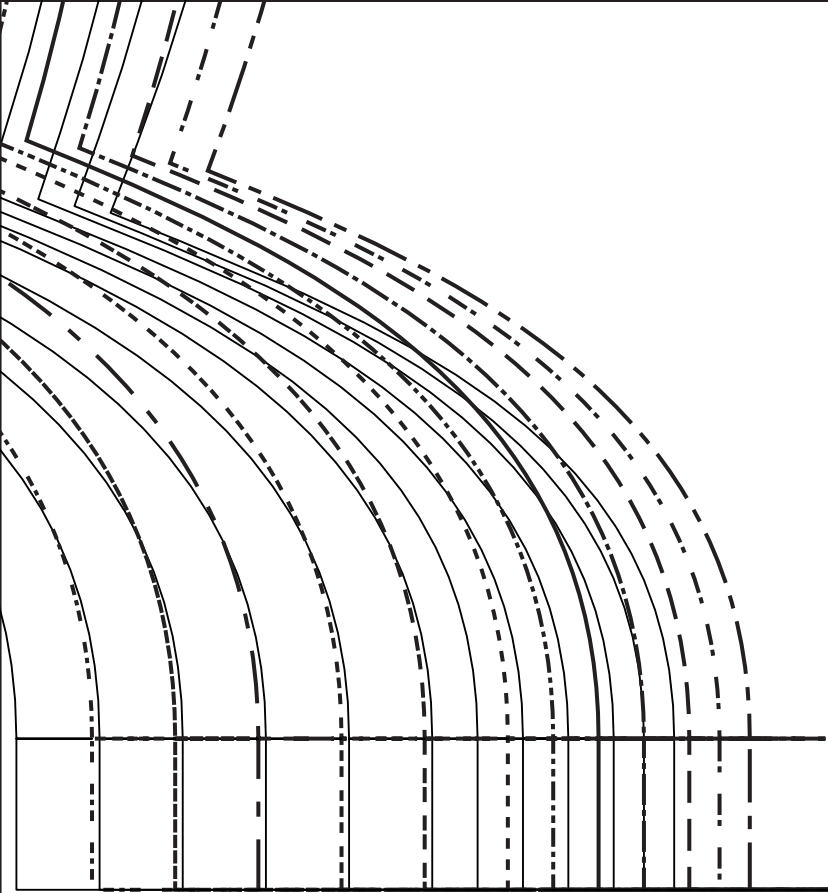



**D**



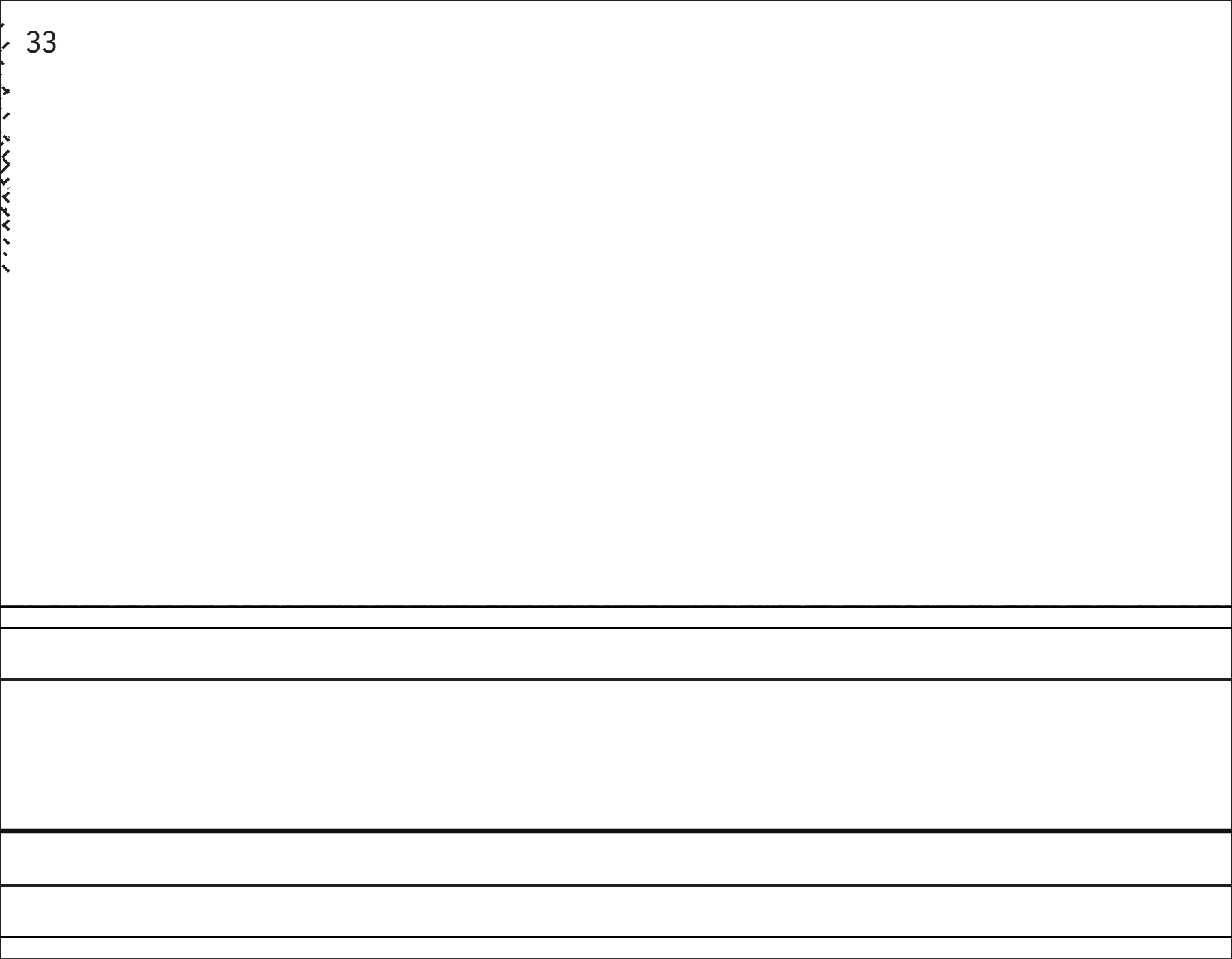



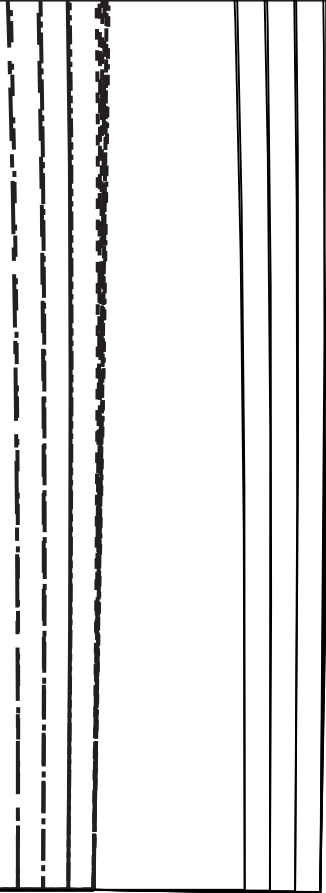

















43

