

Patroonschema / Schéma du Patron / Pattern Diagram /
Übersichtsplan zum Zusammenkleben

1	2	3	4	5	6
7	8	9	10	11	12
13	14	15	16	17	18
19	20	21	22	23	24

Maurice

Broek / Pantalon / Trousers / Hose

Patroondelen / Pièces du patron / Pattern pieces / Schnittteile:

- A** voorpand / devant / front panel /
Vorderteil
- B** rugpand / dos / back panel /
Rückenteil
- C** zak / poche / pockets / Tasche
- D** tailleband / ceinture / waistband /
Bund

Controlevierkant / Carré de controle / Test square / Kontrollquadrat

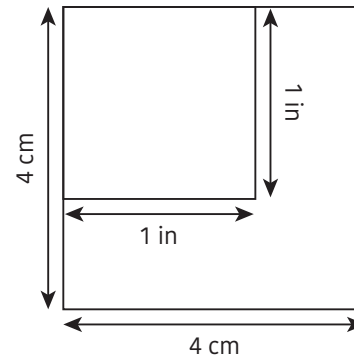

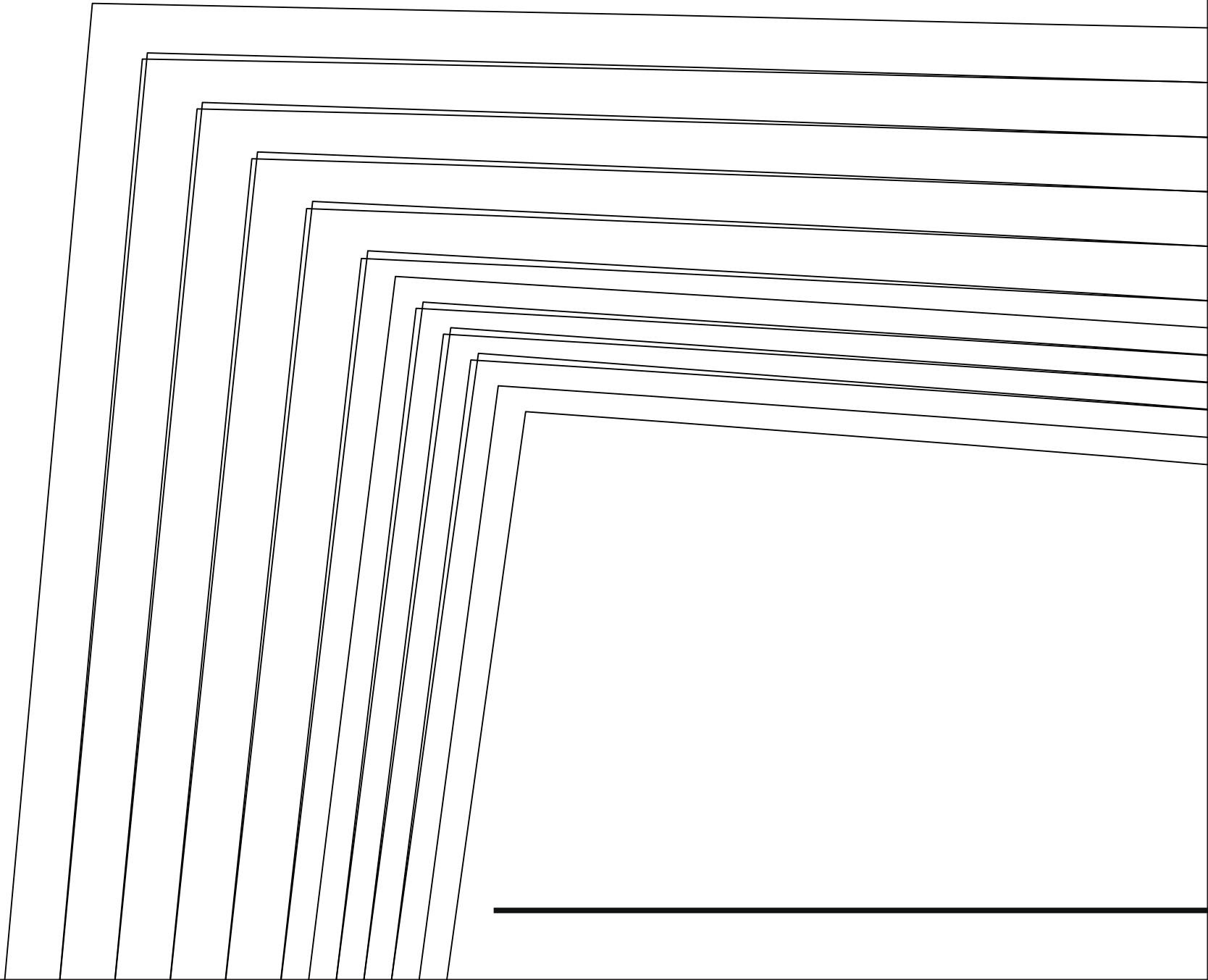

3

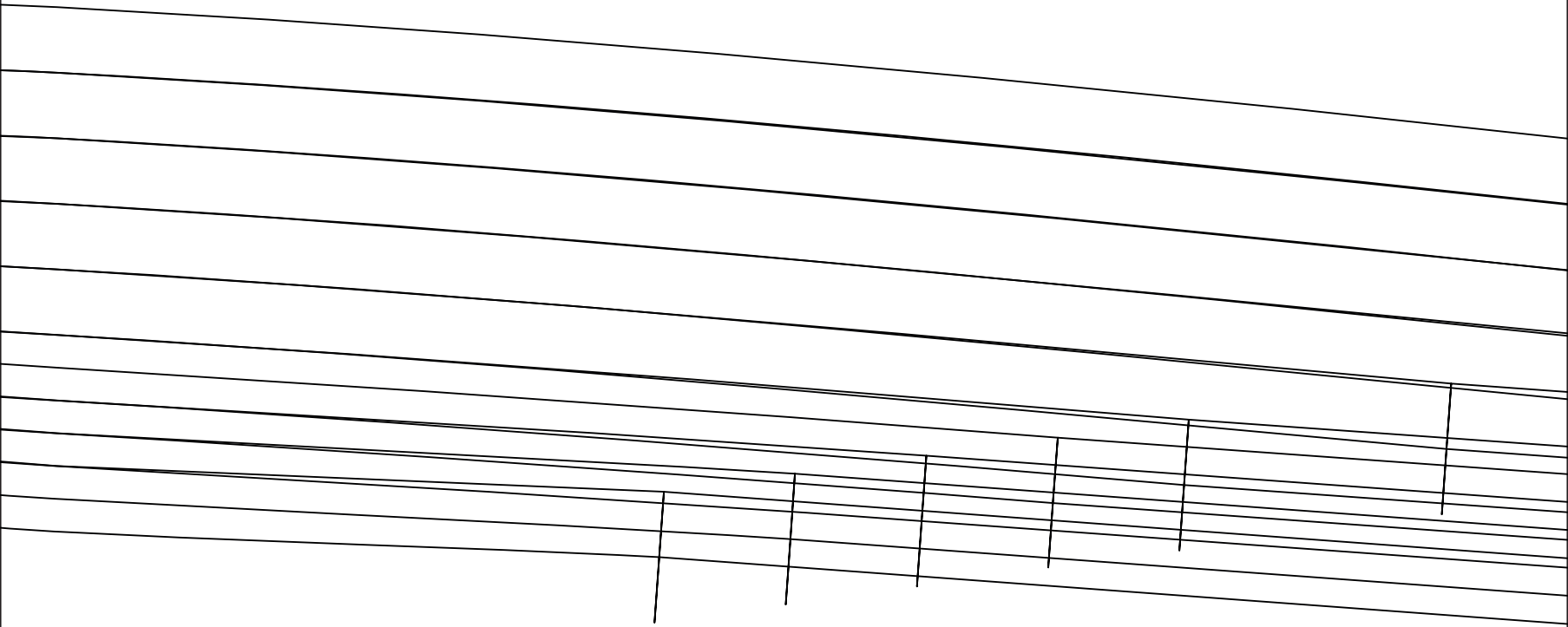

B

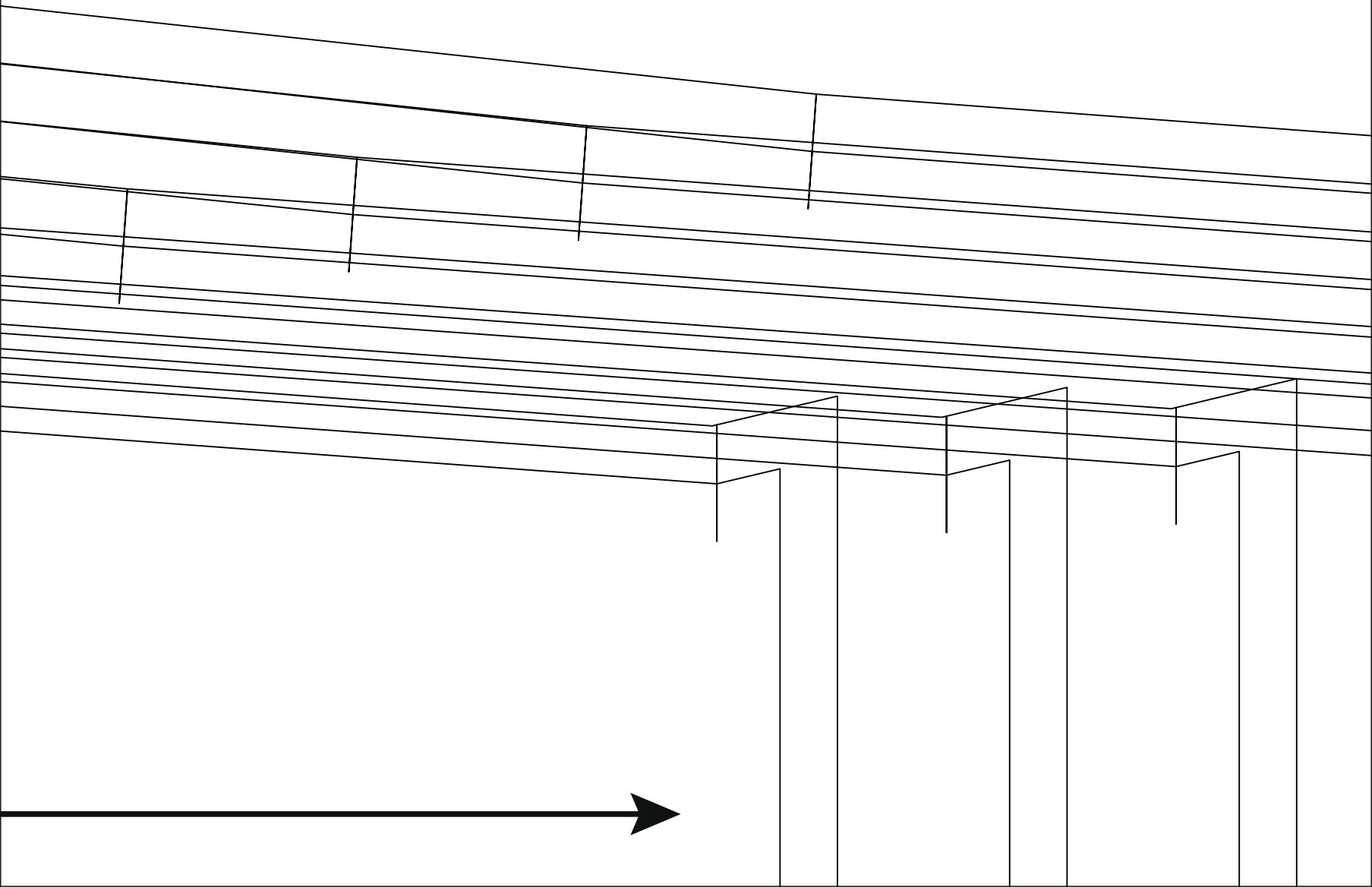

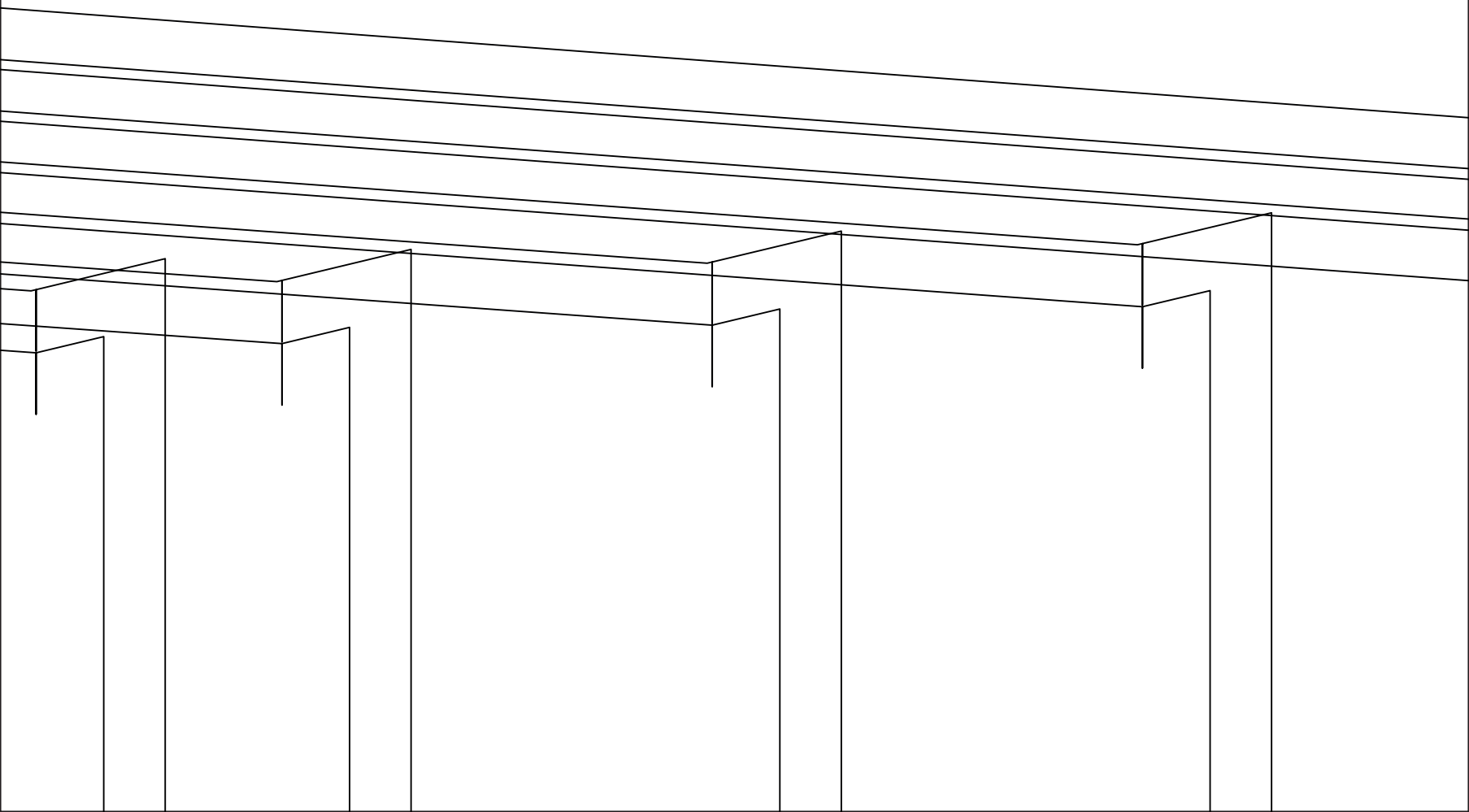

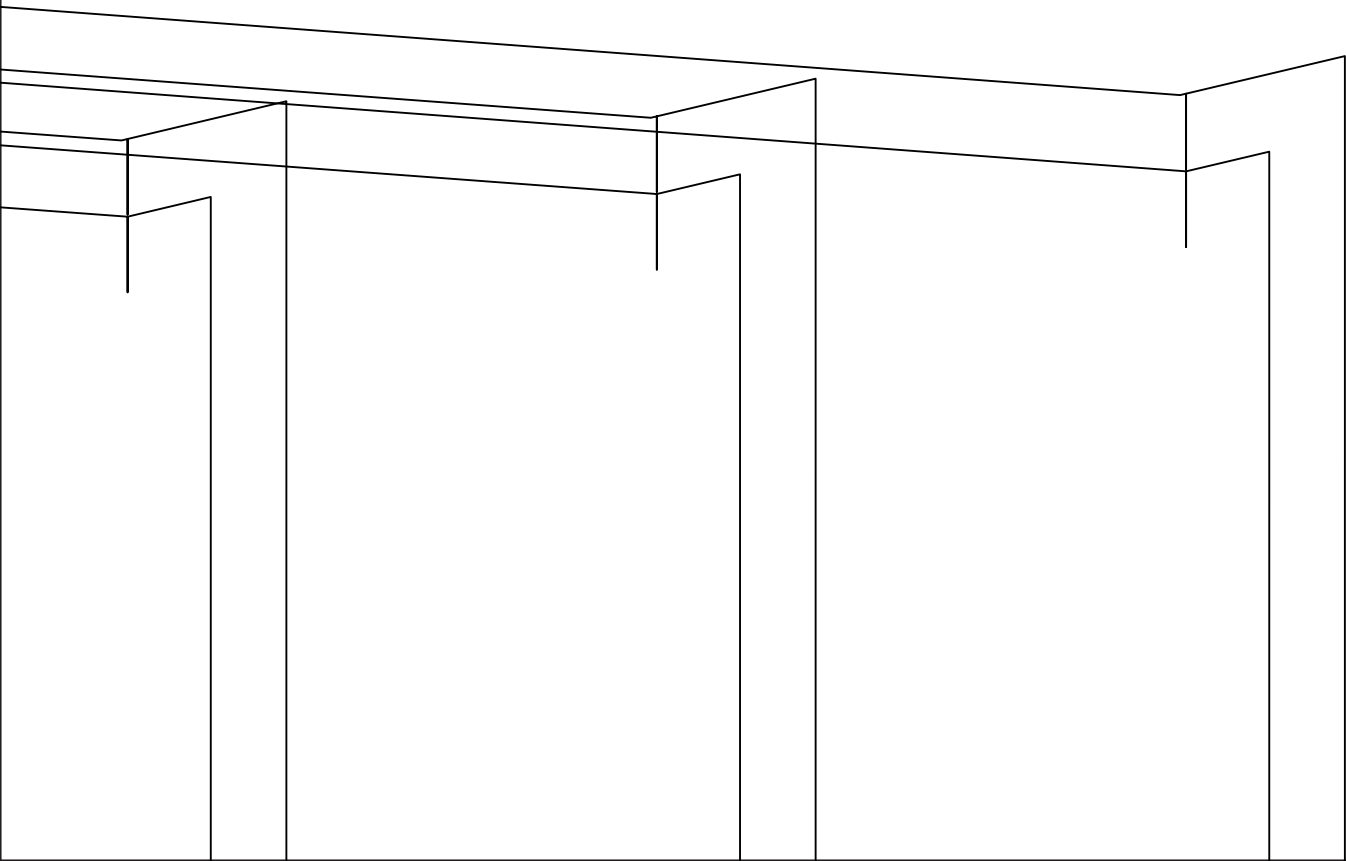

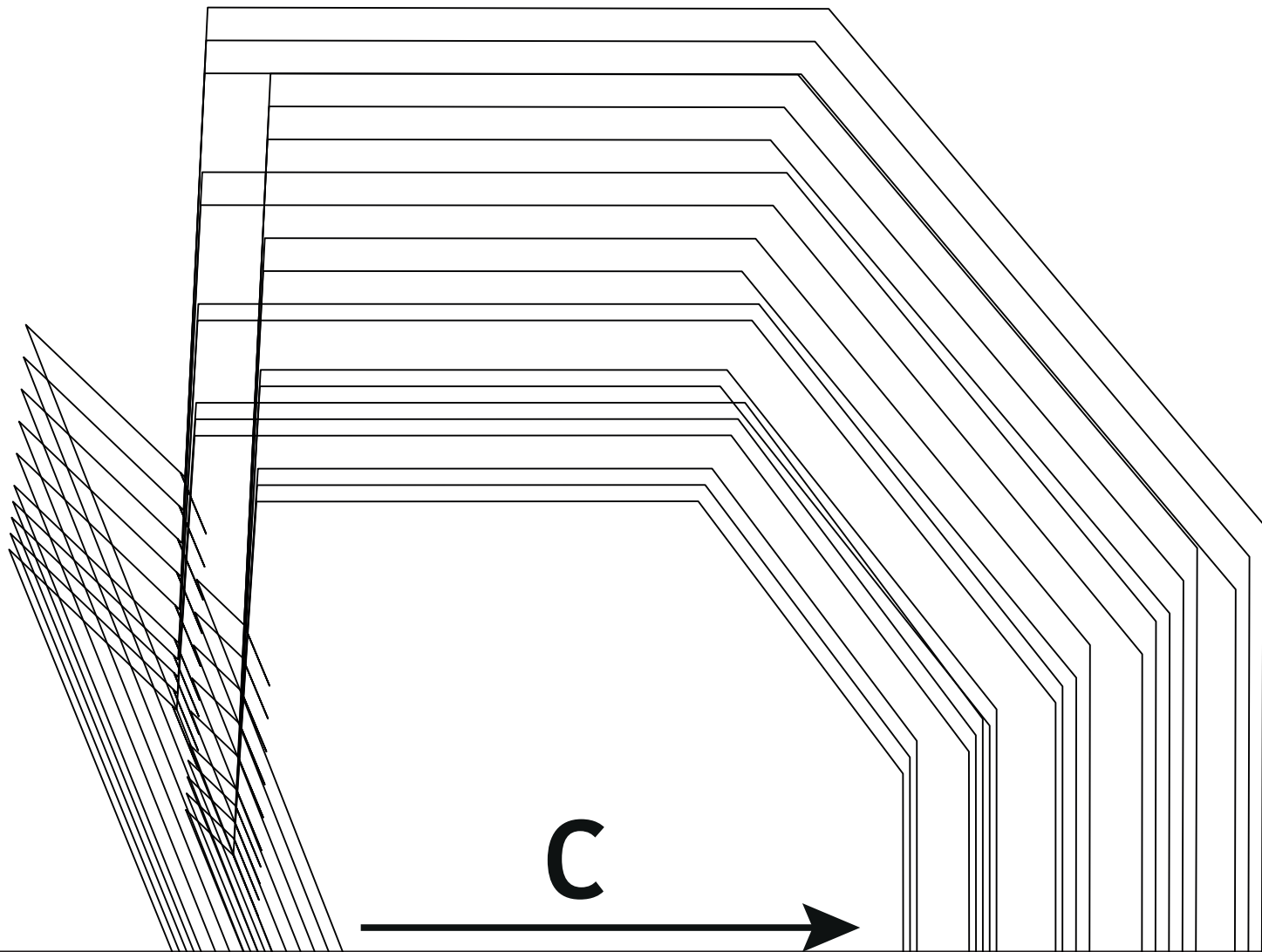

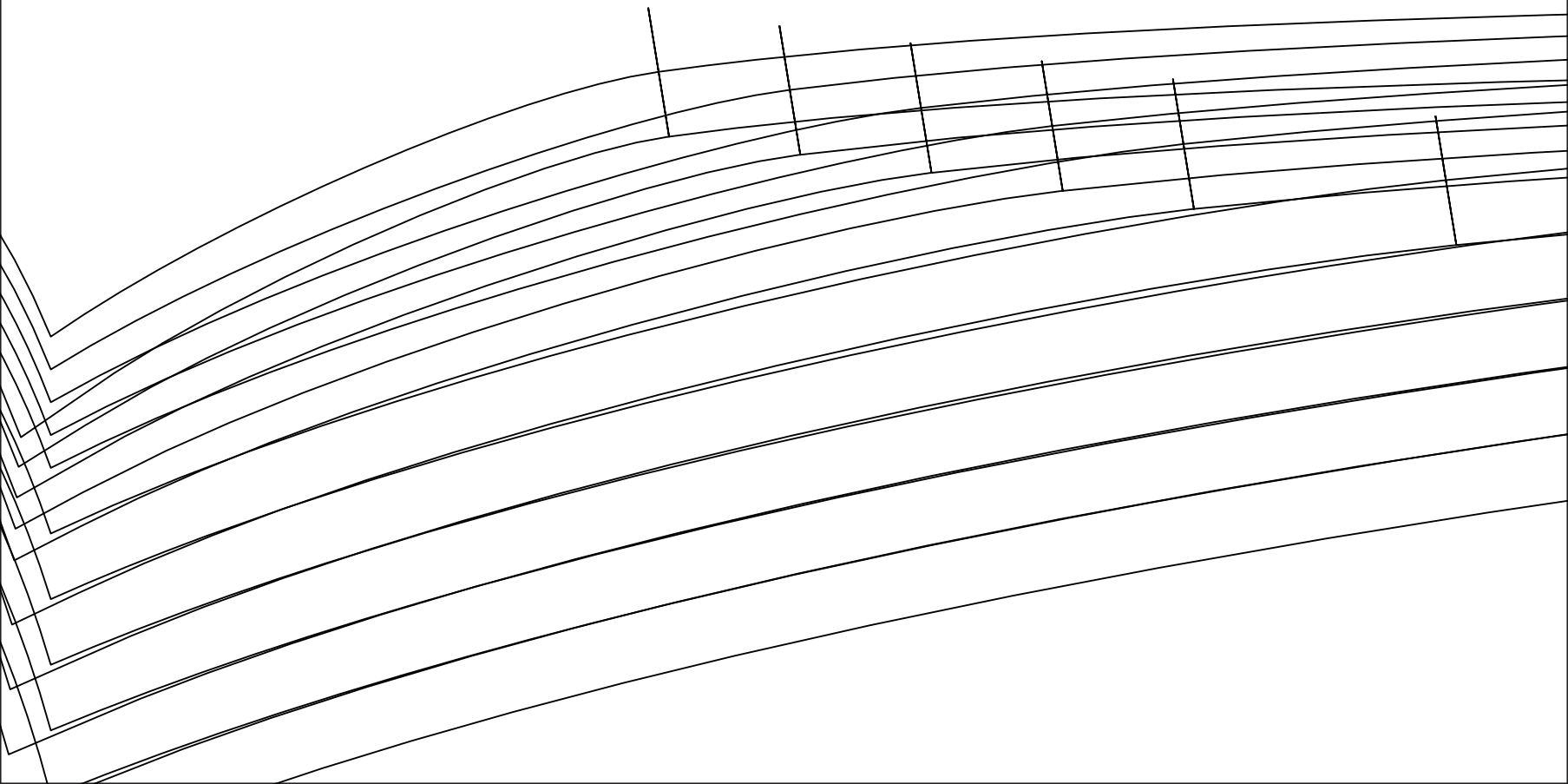

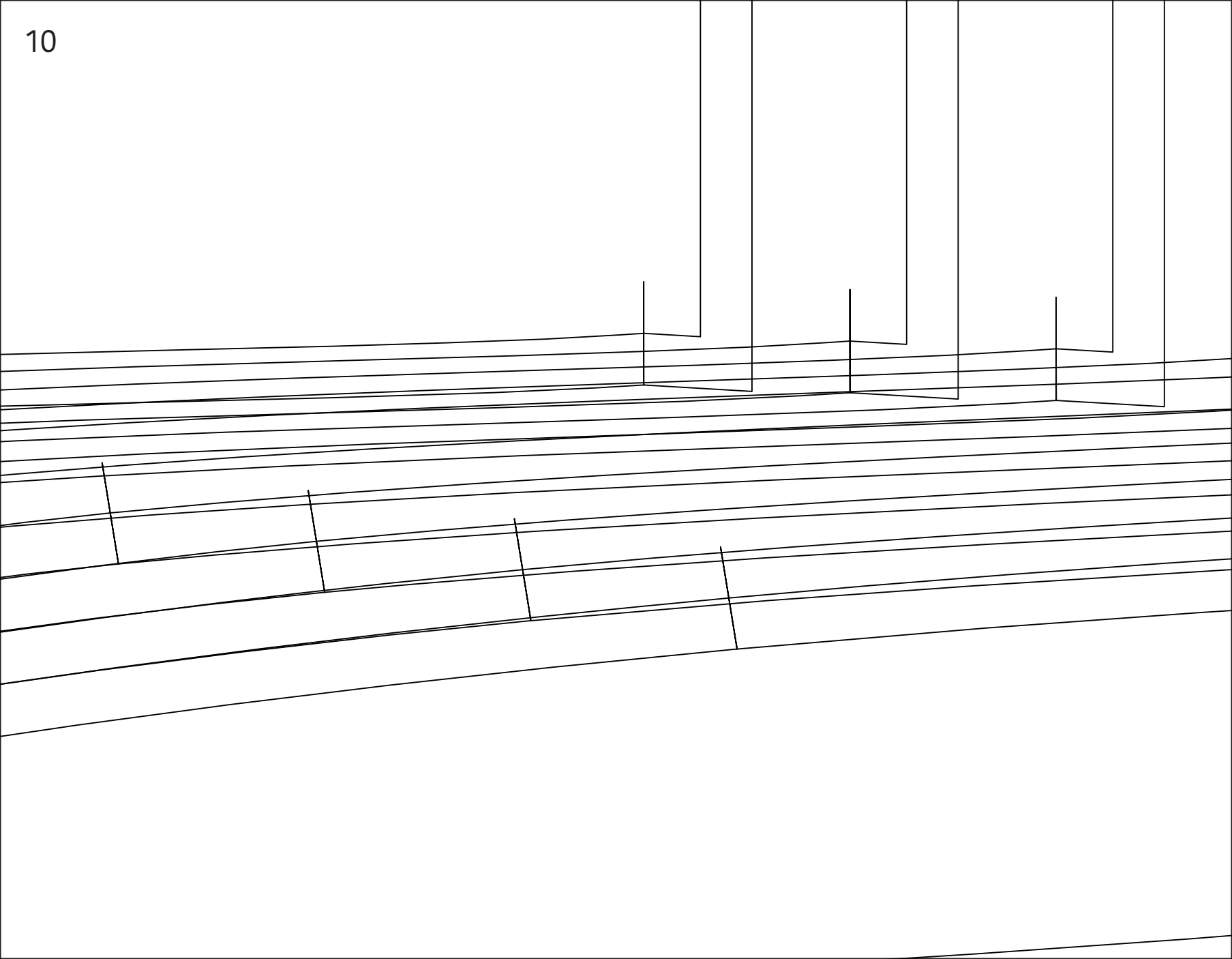

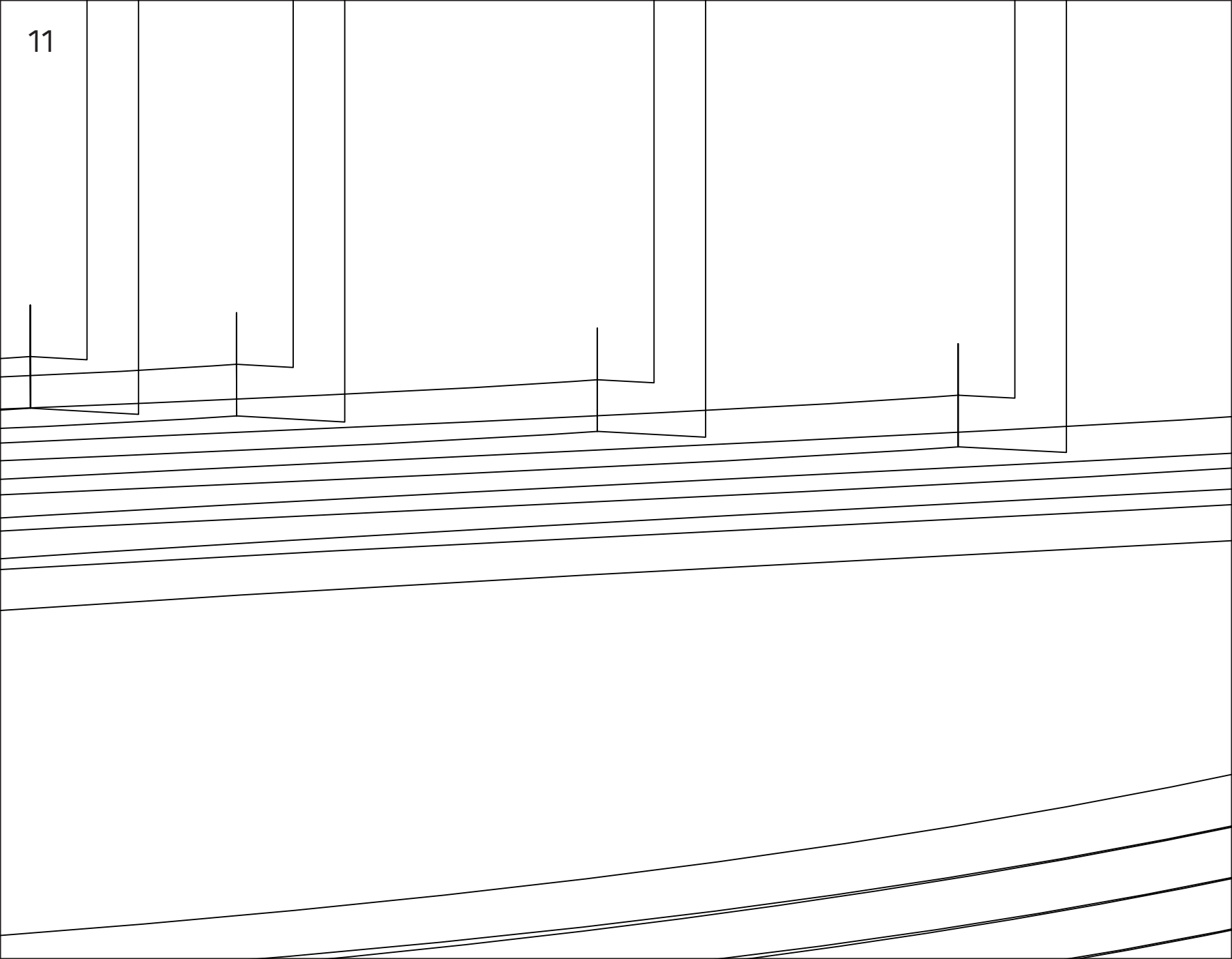

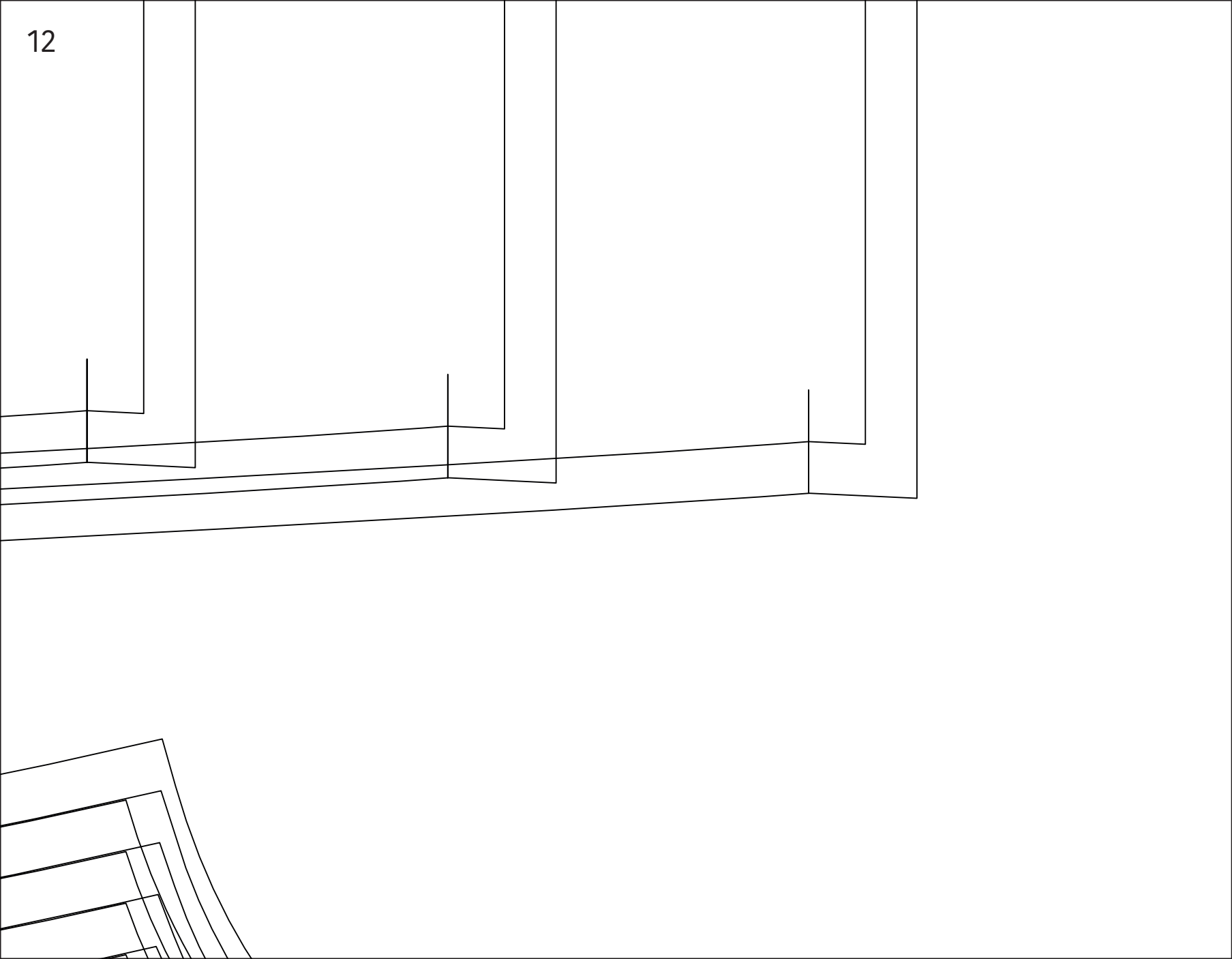

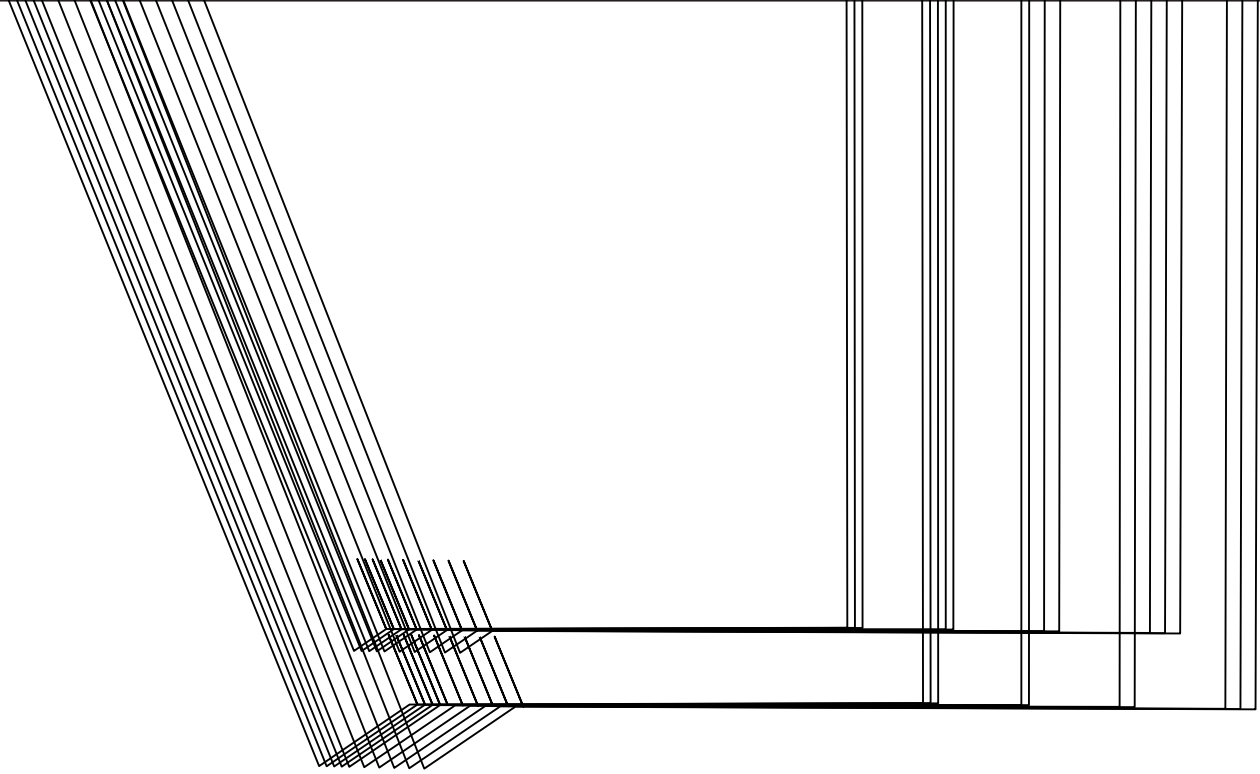

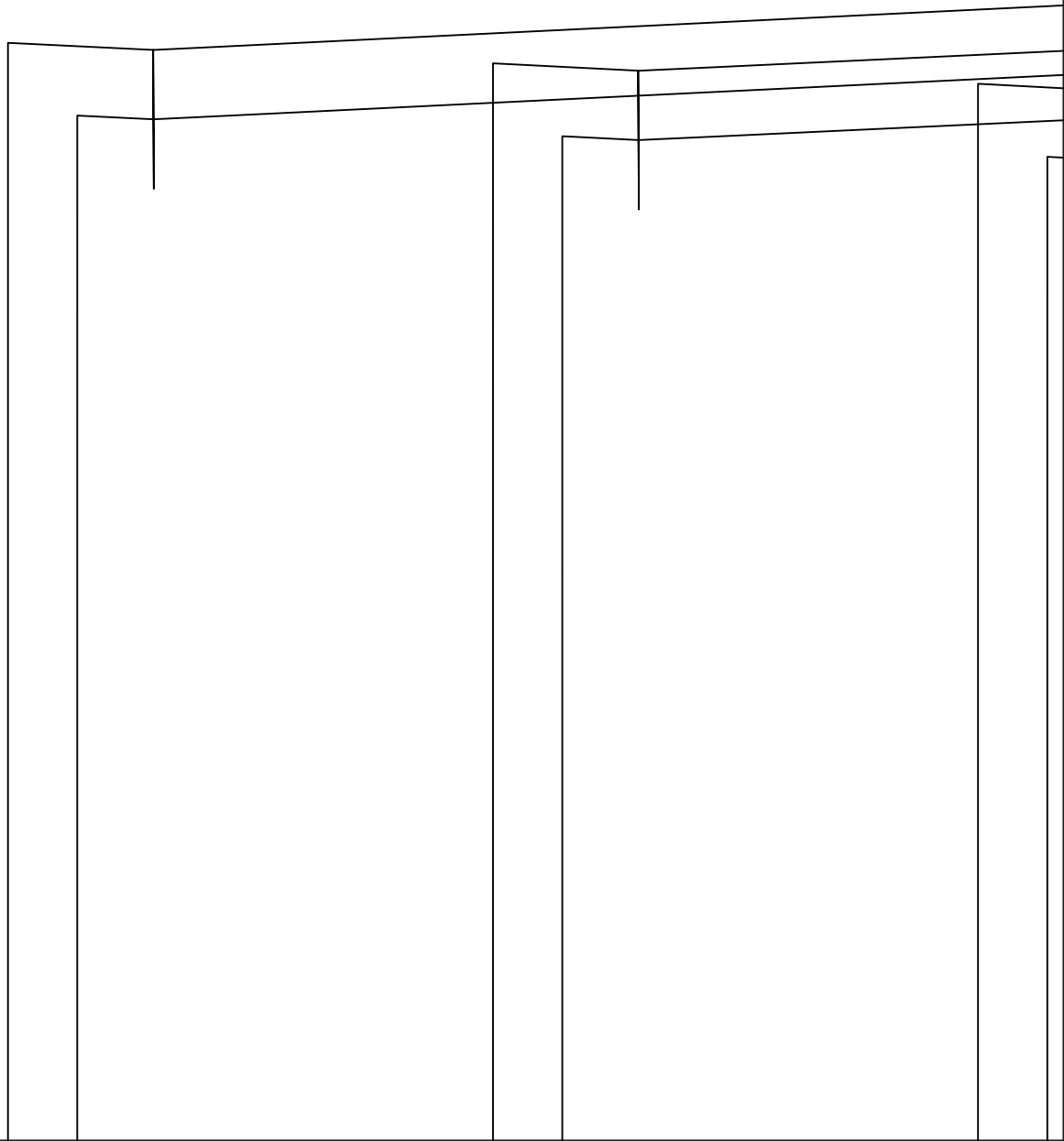

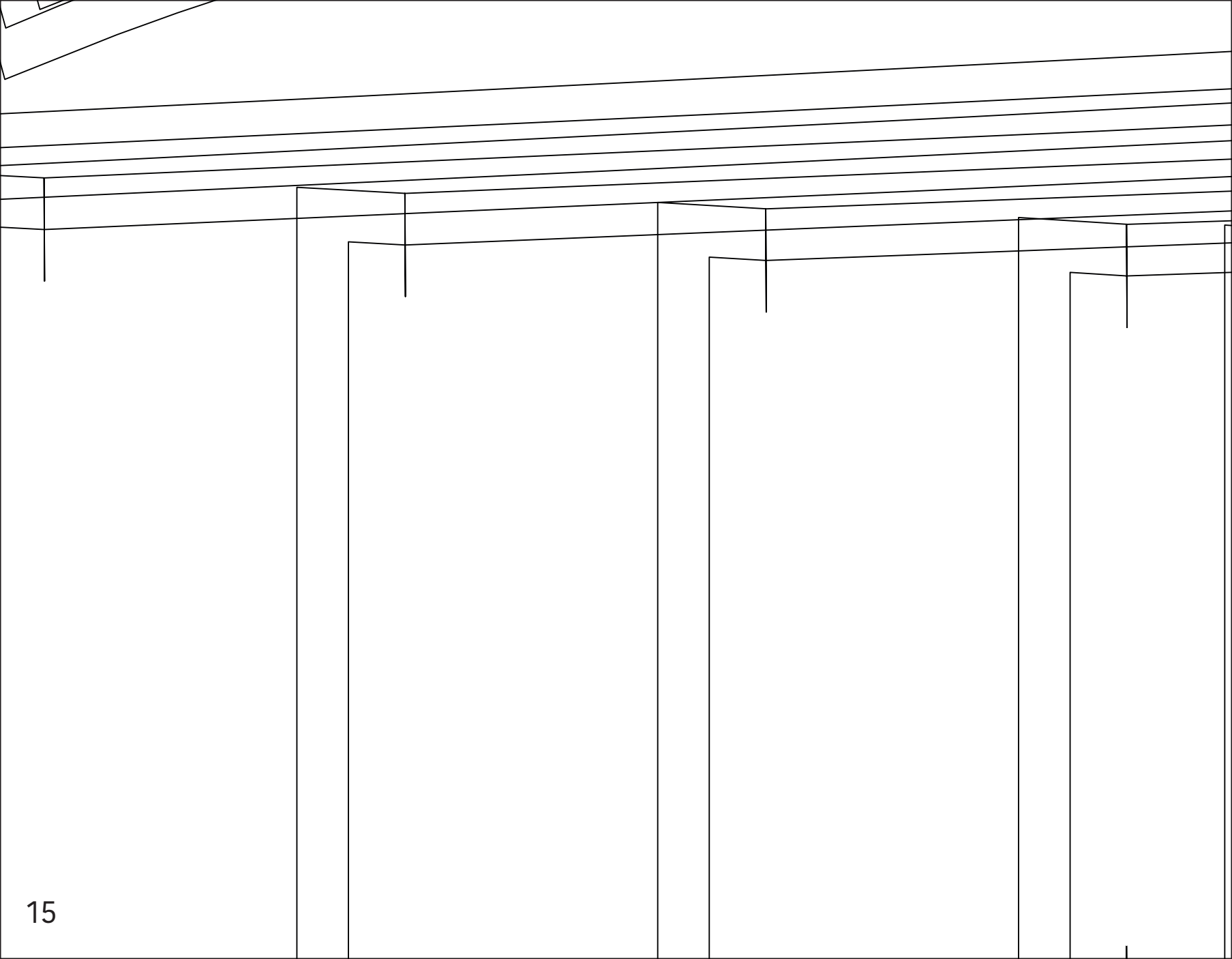

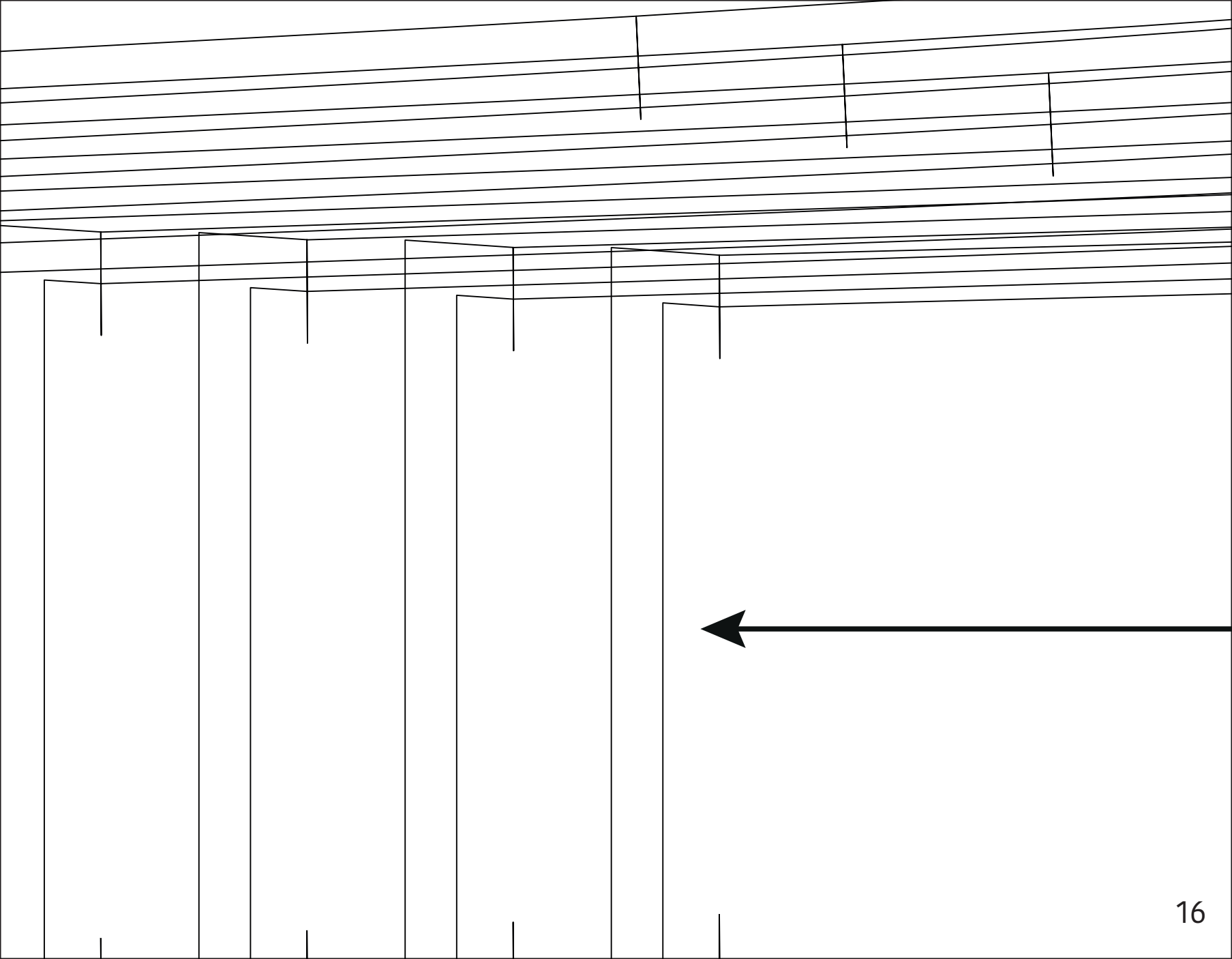

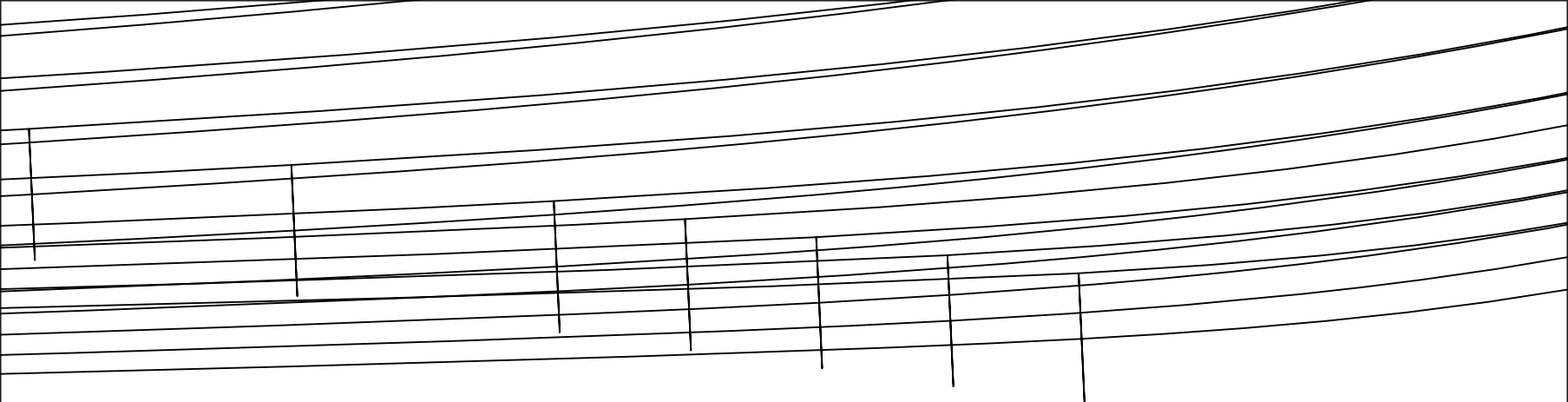

A

