

Kay

Jas / Veste /
Jacket / Jacke

Maten / Tailles / Sizes / Größen:

| | |
|-------------------------|----|
| | 30 |
| ----- | 32 |
| ----- | 34 |
| - . - . - . - . - . - . | 36 |
| ----- | 38 |
| ----- | 40 |
| ----- | 42 |
| ----- | 44 |
| ----- | 46 |
| ----- | 48 |

Patroonschema / Schéma du Patron / Pattern Diagram /
Übersichtsplan zum Zusammenkleben

| | | | | | |
|---------------|----|----|----|----|----|
| 1 | 2 | 3 | 4 | 5 | 6 |
| 7 | 8 | 9 | 10 | 11 | 12 |
| 13 | 14 | 15 | 16 | 17 | 18 |
| 19 | 20 | 21 | 22 | 23 | 24 |
| 25 | 26 | 27 | 28 | 29 | 30 |

**Patroondelen / Pièces du patron /
Pattern pieces / Schnittteile:**

- A** voorpand / devant / front panel /
Vorderteil
- A'** voering VP / doublure DV / lining FP /
Futter VT
- B** zijpand VP / côté DV / side FP /
seitliches VT
- B'** voering zijpand VP / doublure côté
DV / lining side FP /
Futter seitliches VT
- C** rugpand / dos / back panel /
Rückenteil
- C'** voering RP / doublure DS / lining BP /
Futter RT
- D** zijpand RP / côté DS / side BP /
seitliches RT
- D'** voering zijpand RP / doublure côté
DS / lining side BP /
Futter seitliches RT
- E** mouw VP / manche DV / sleeve FP /
Ärmel VT
- E'** voering mouw VP / doublure manche
DV / lining sleeve FP /
Futter Ärmel VT
- F** mouw RP / manche DS / sleeve BP /
Ärmel RT
- F'** voering mouw RP / doublure manche
DS / lining sleeve BP /
Futter Ärmel RT
- G** beleg VP / parementure DV /
facing FP / Besatz VT
- H** beleg RP / parementure DS /
facing BP / Besatz RT
- I** kraag / col / collar / Kragen
- J** polsboord / bord manchette / cuff /
Ärmelbündchen
- K** zoomboord VP / liseré d'ourlet DV /
trim FP / Saumbund VT
- L** zoomboord RP / liseré d'ourlet DS /
trim BP / Saumbund RT

**Controlevierkant / Carré de controle
/ Test square / Kontrollquadrat**

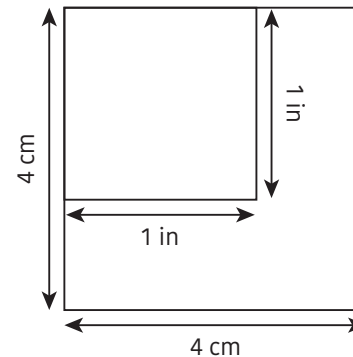

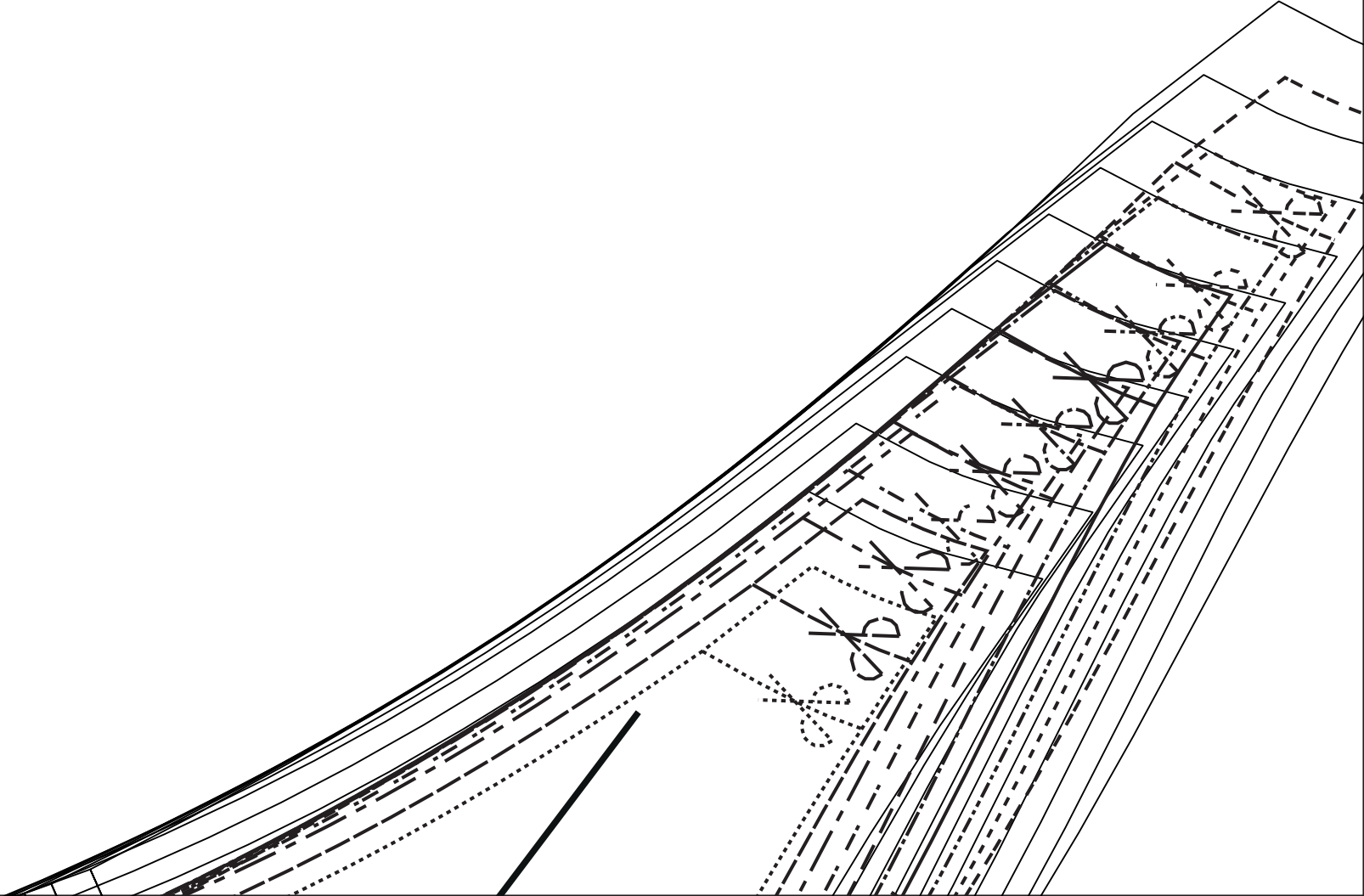

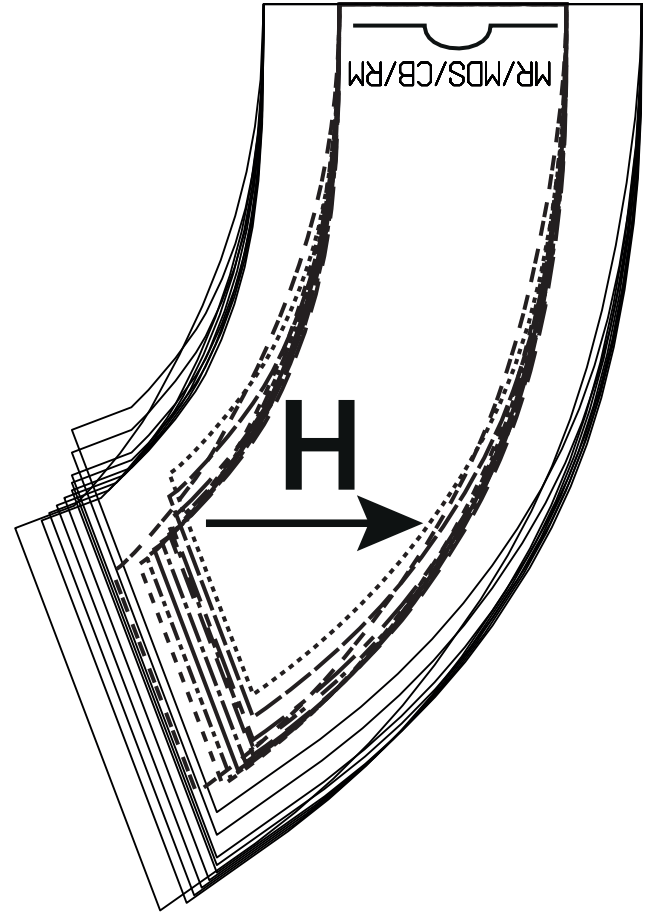
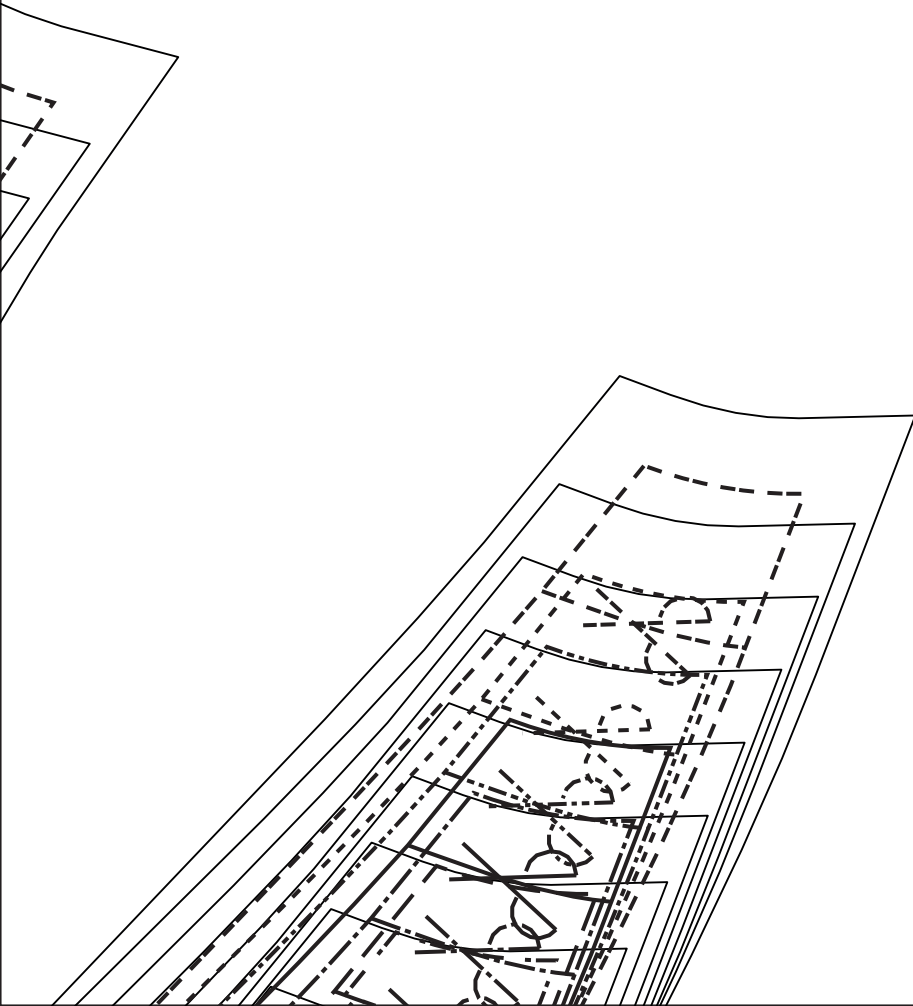

5

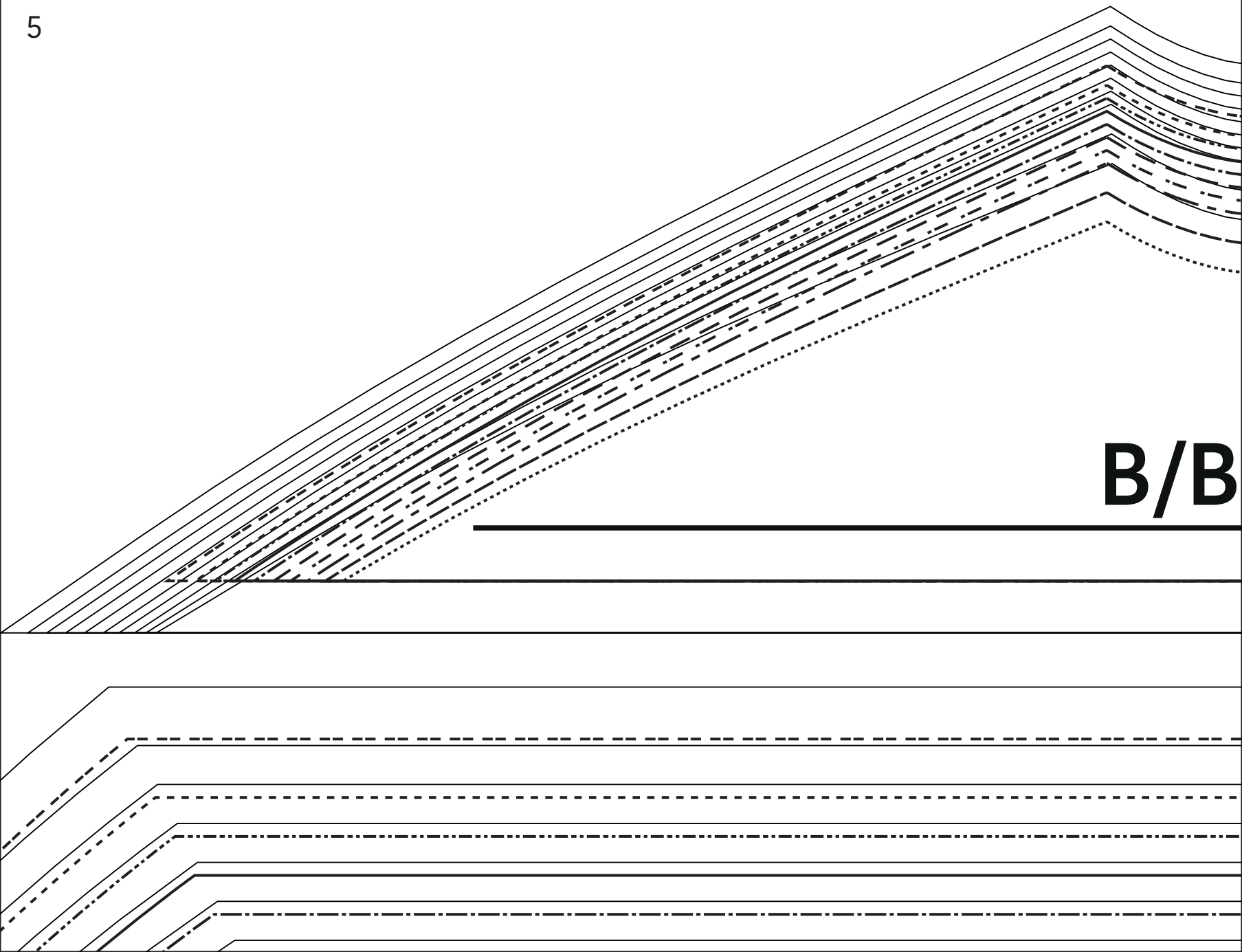

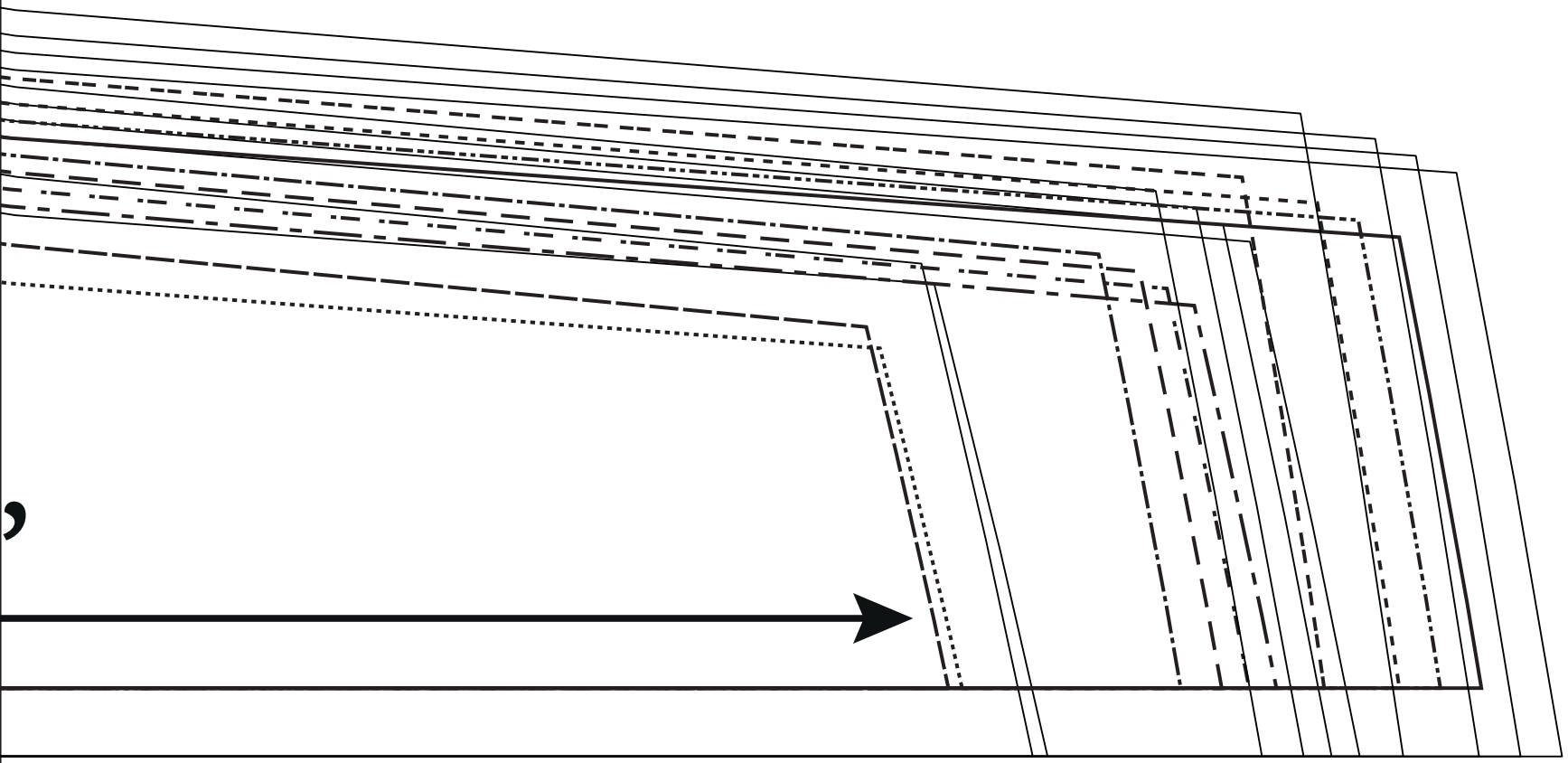

,

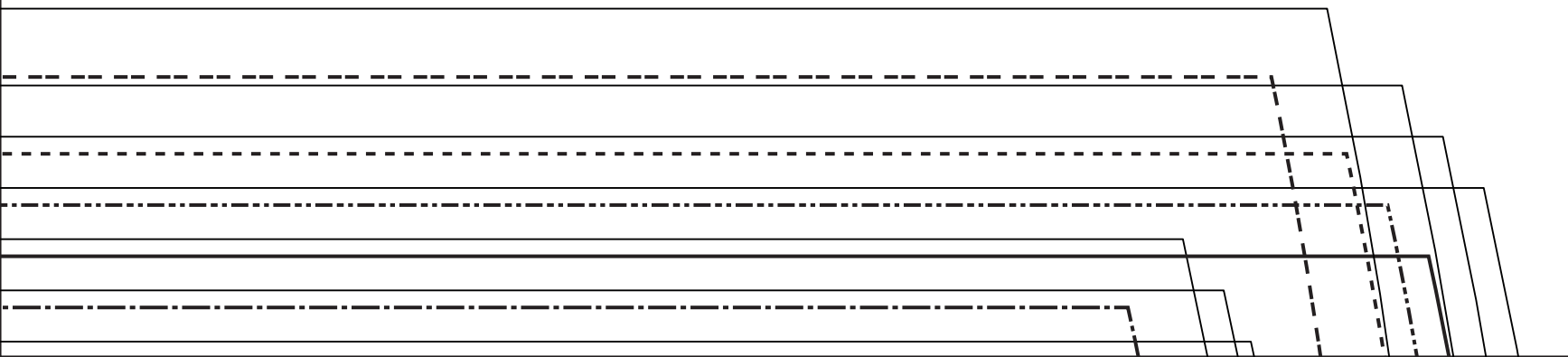

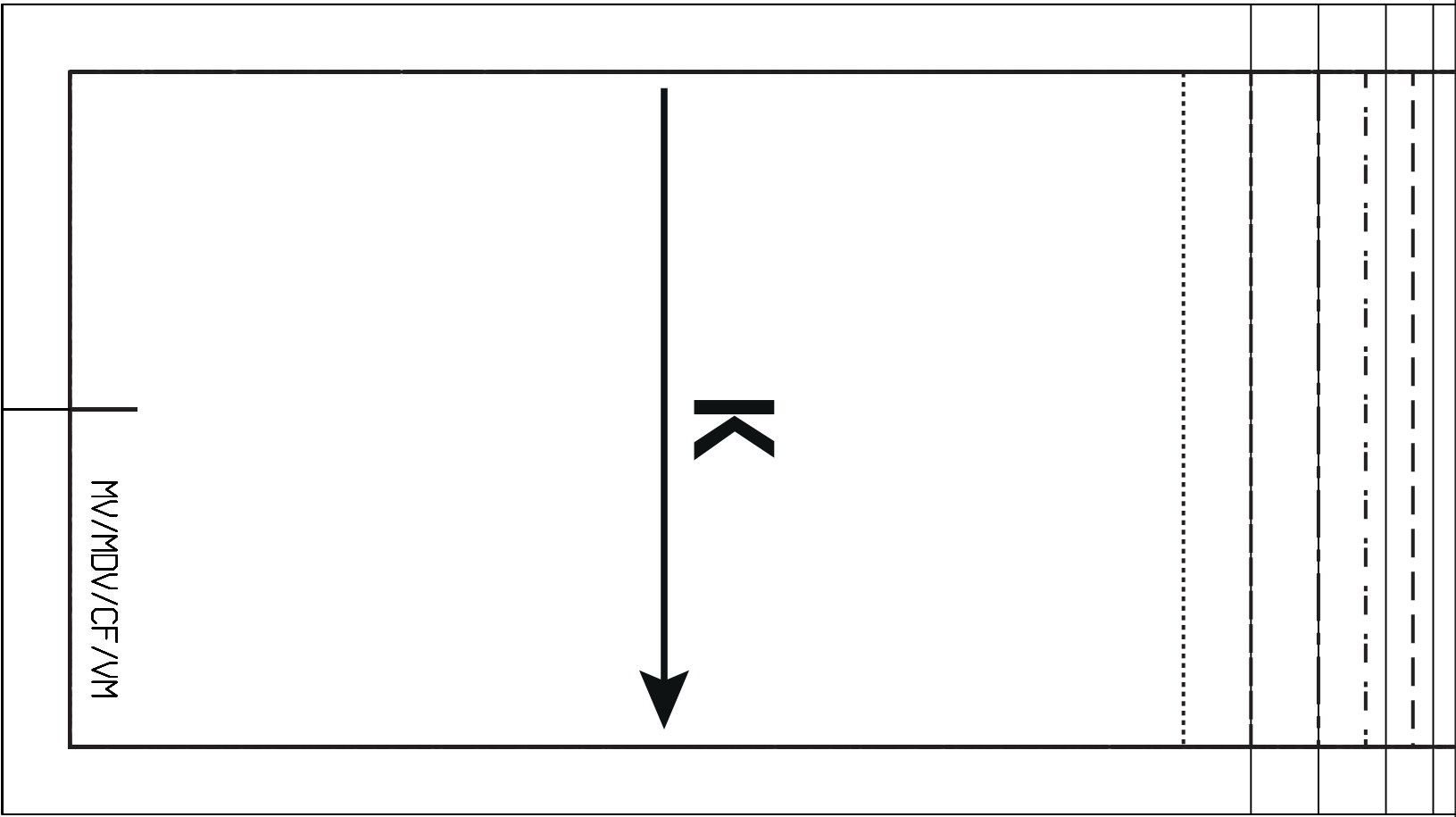

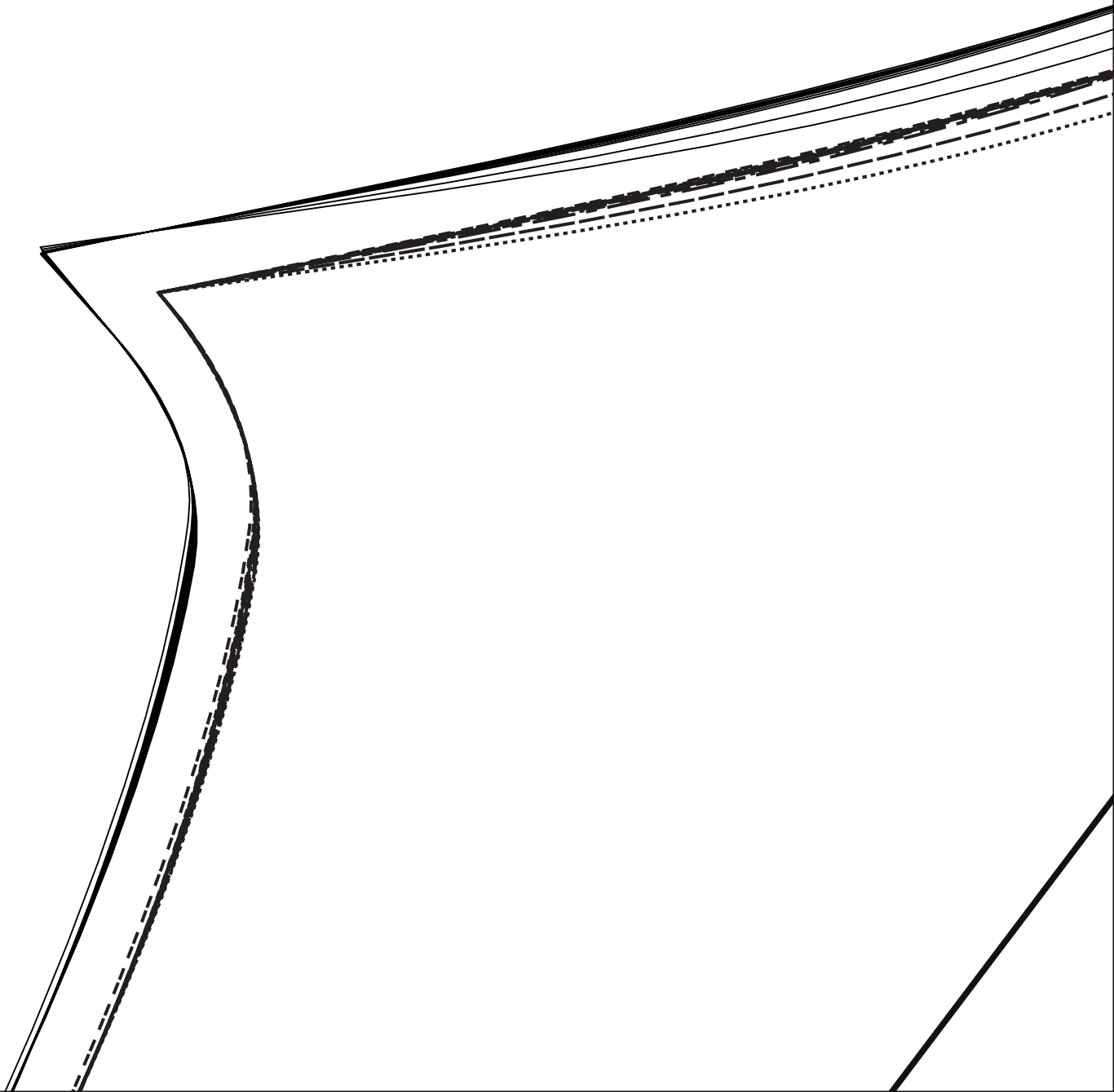
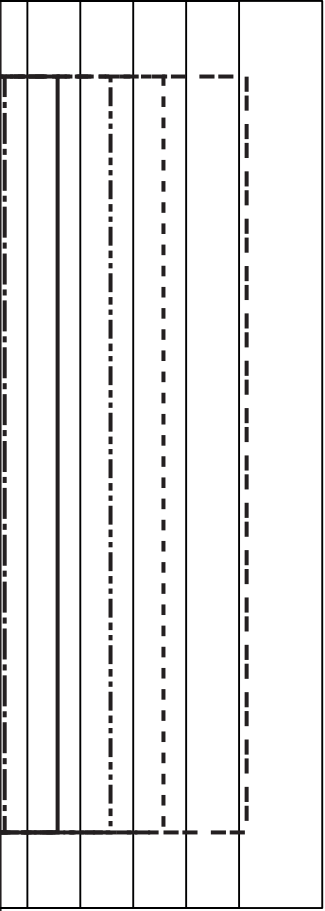

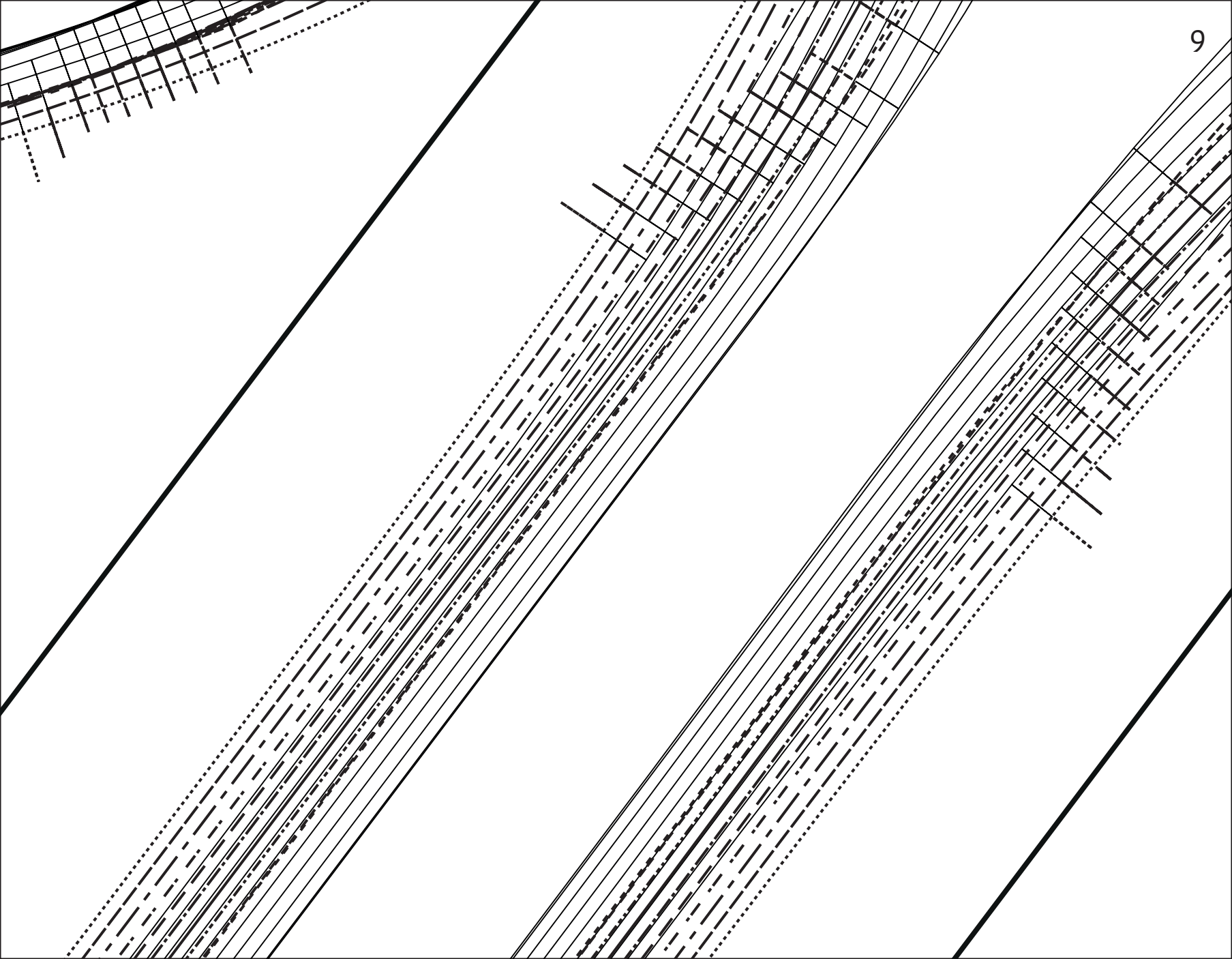

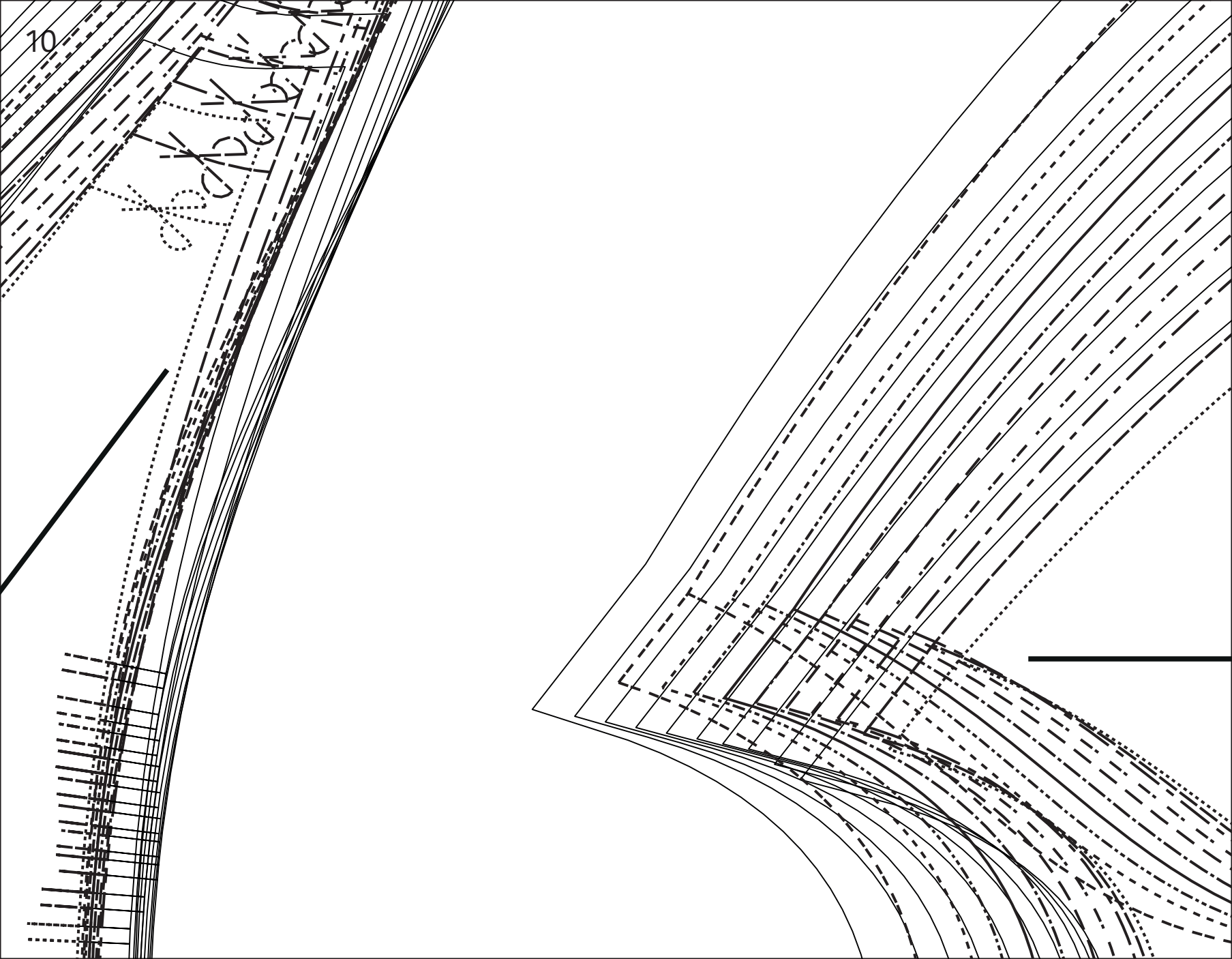

A/A'

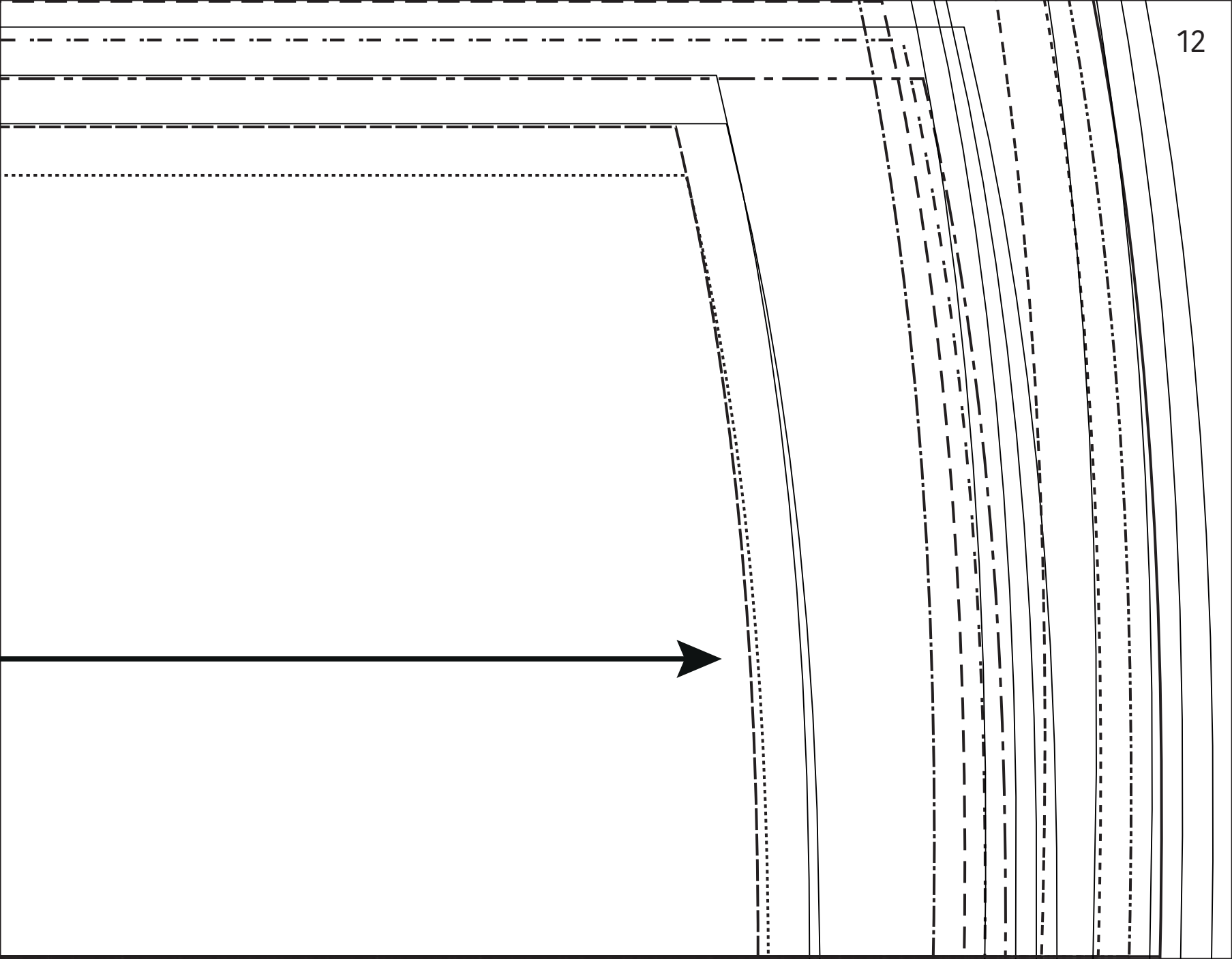

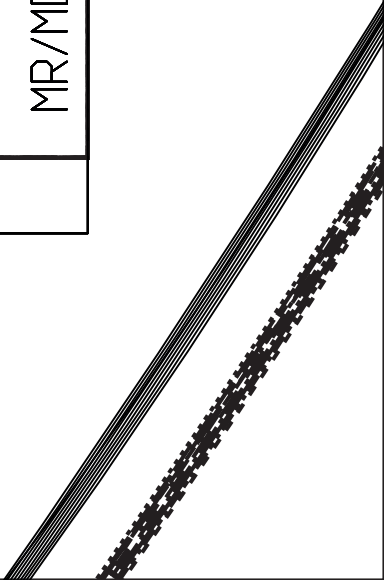
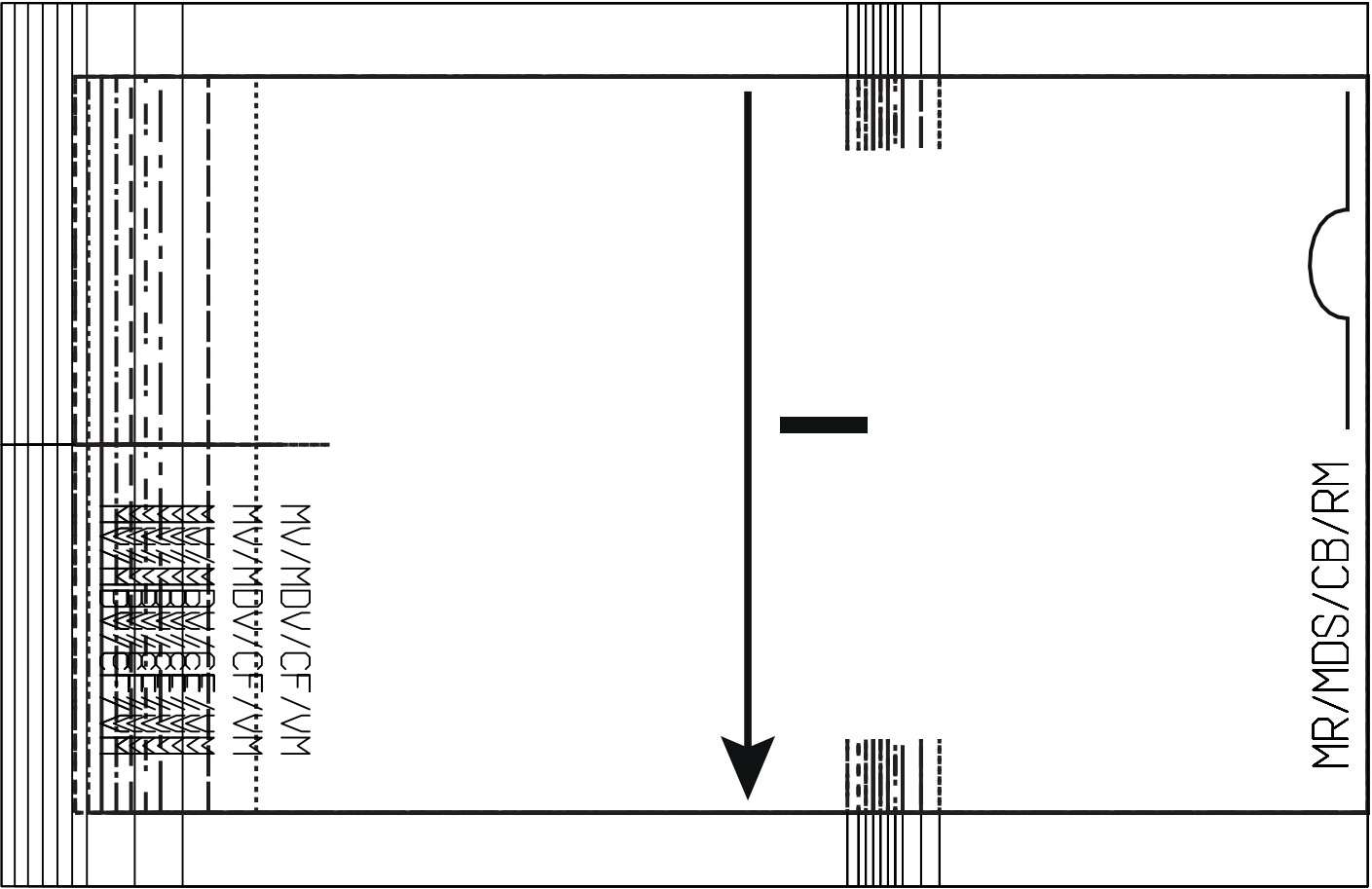

EVE,

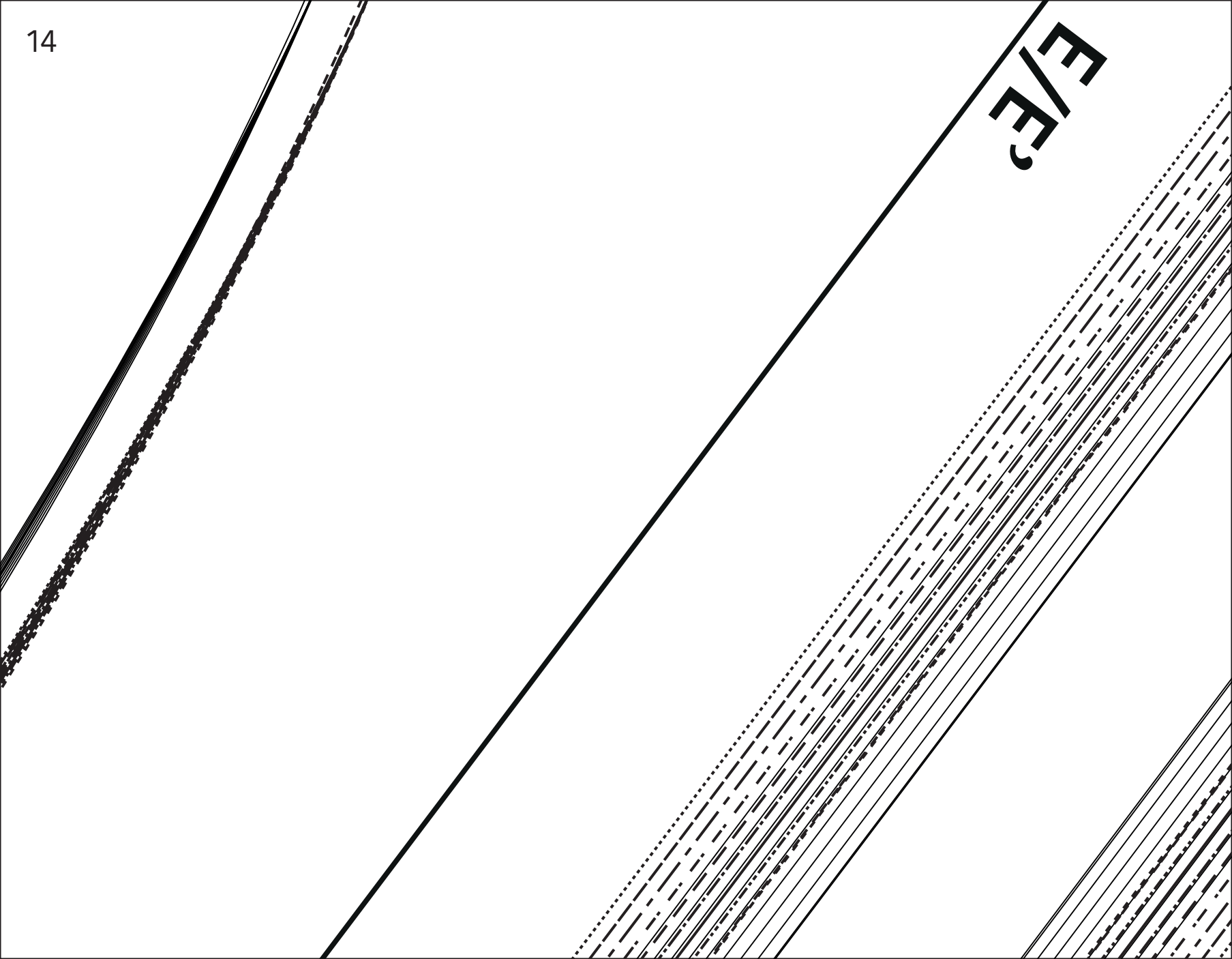

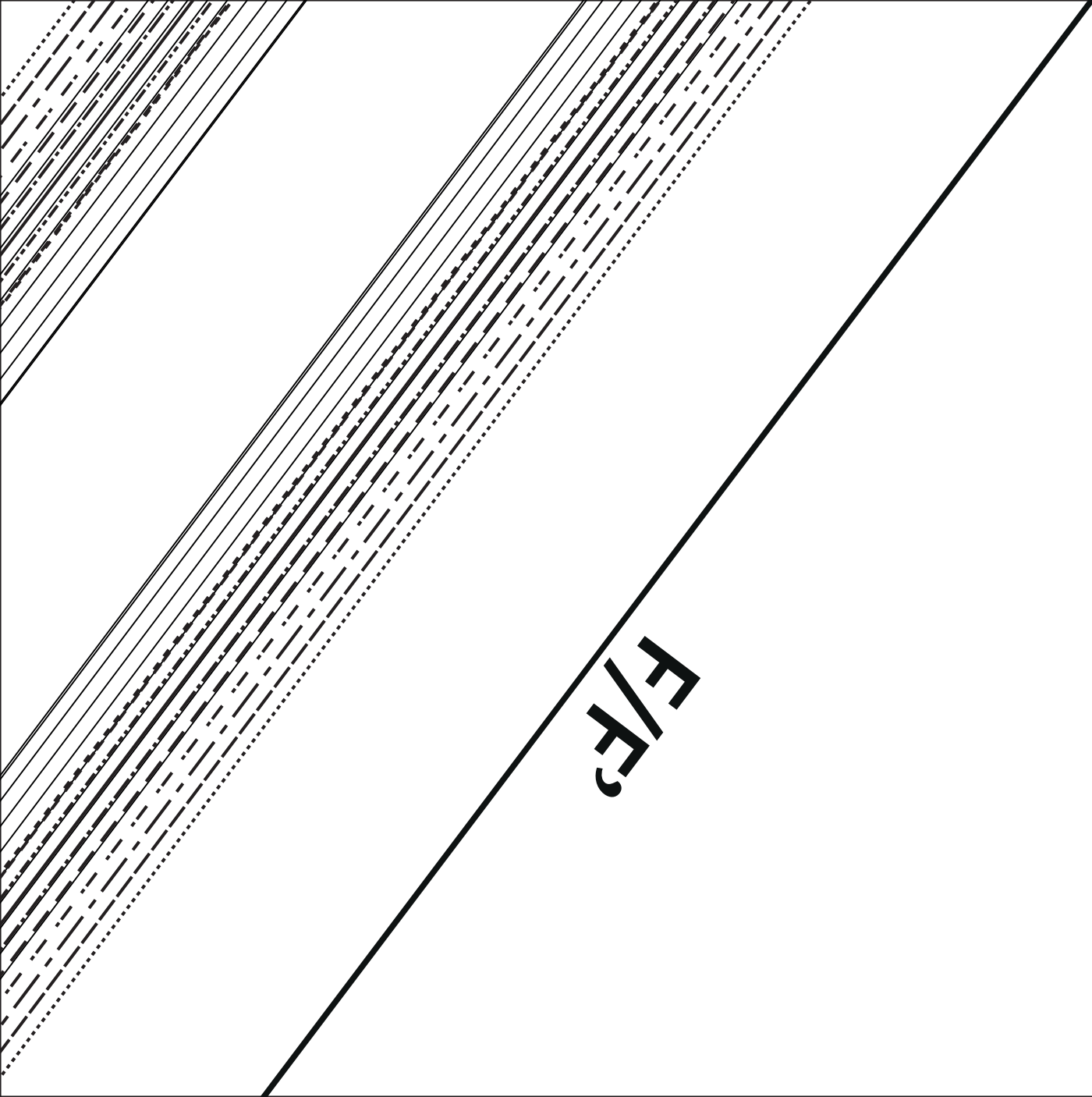

FF,

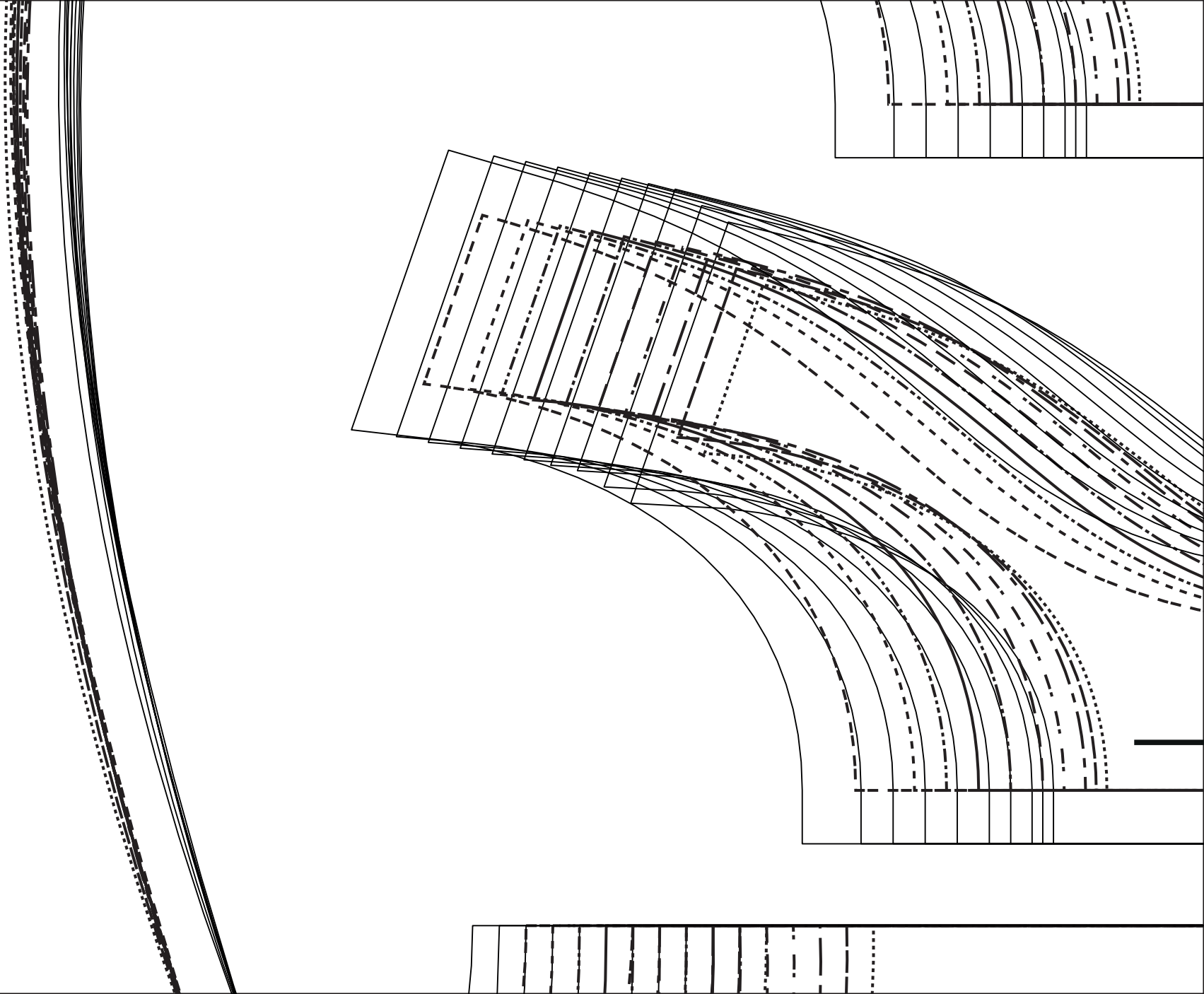

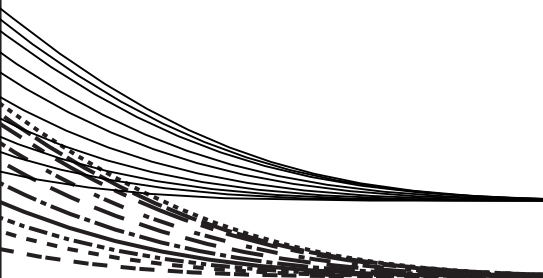

G

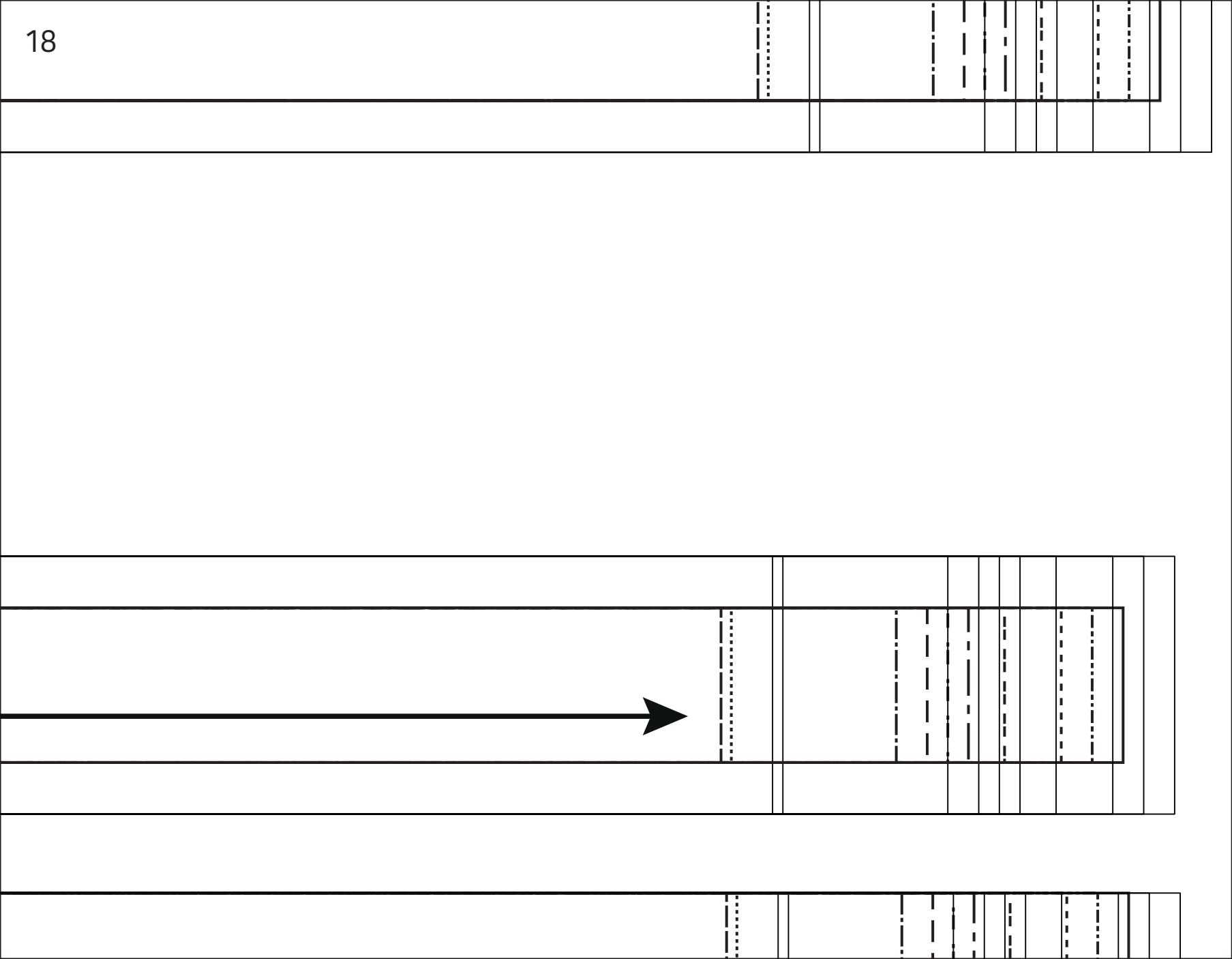

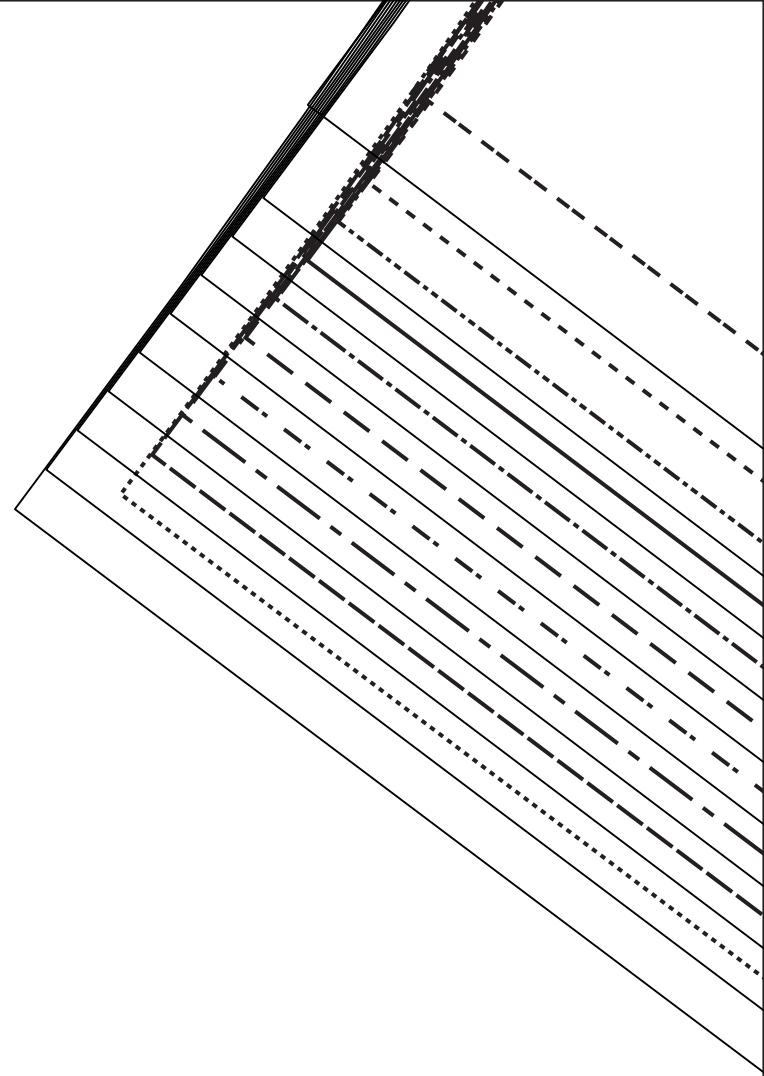

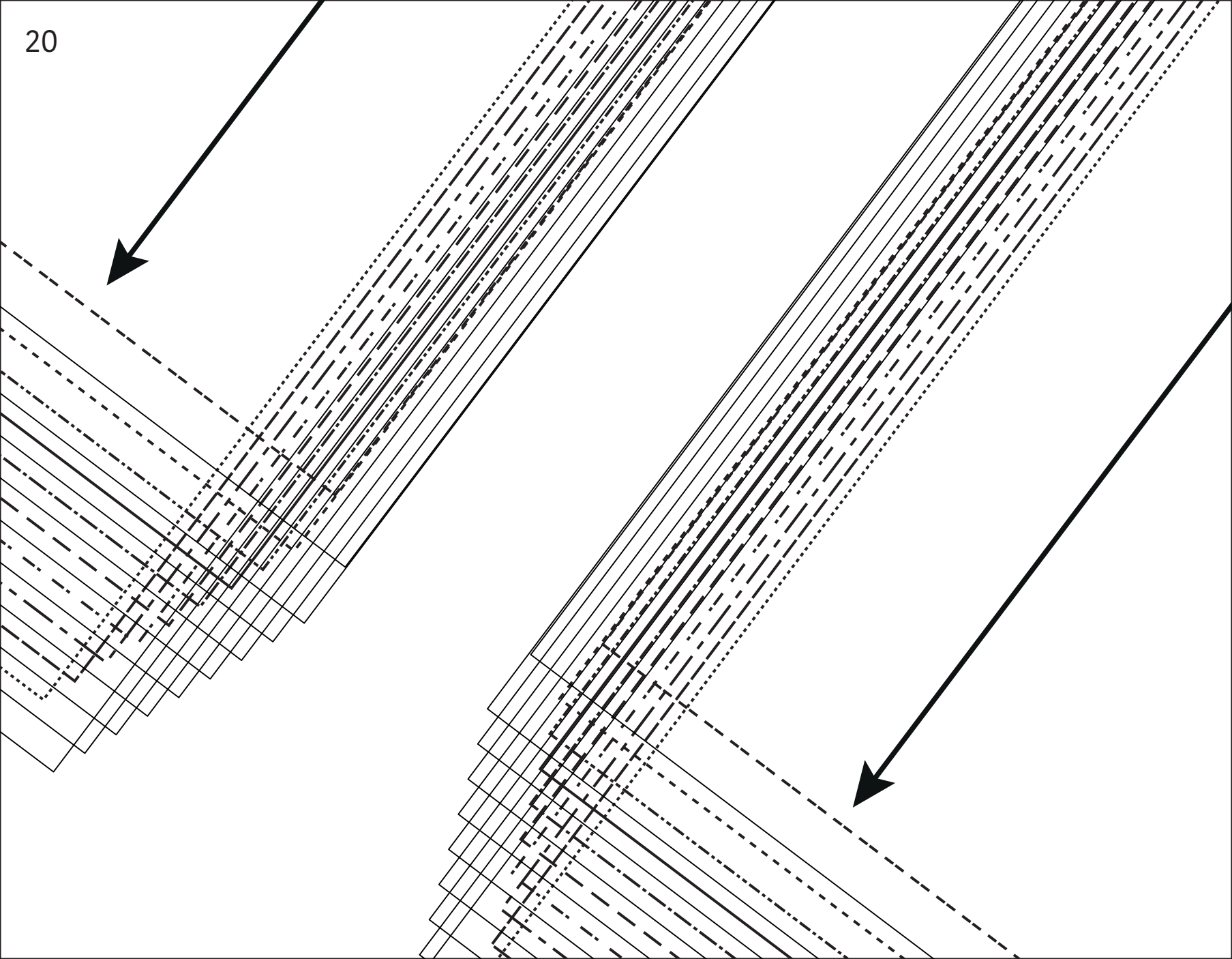

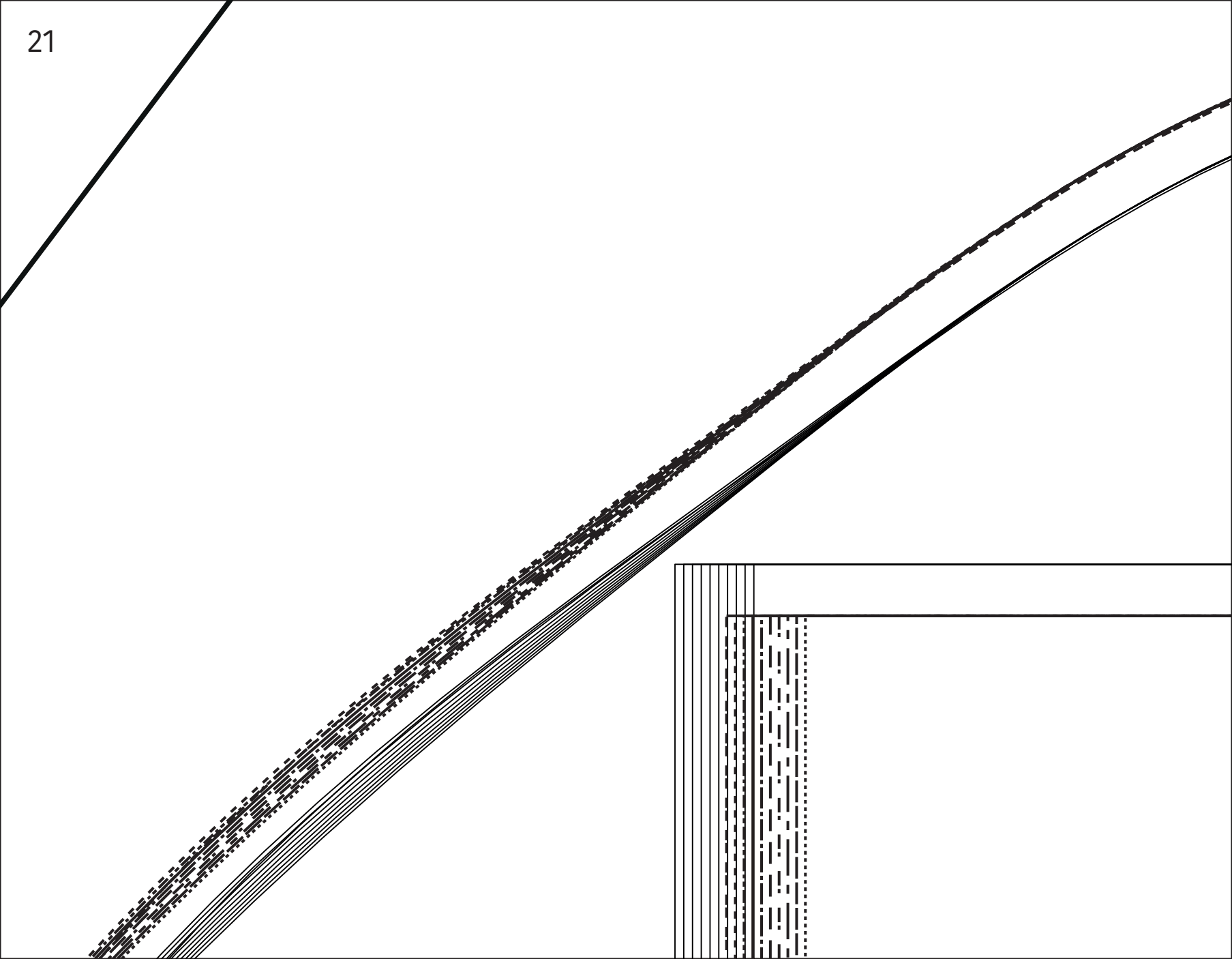

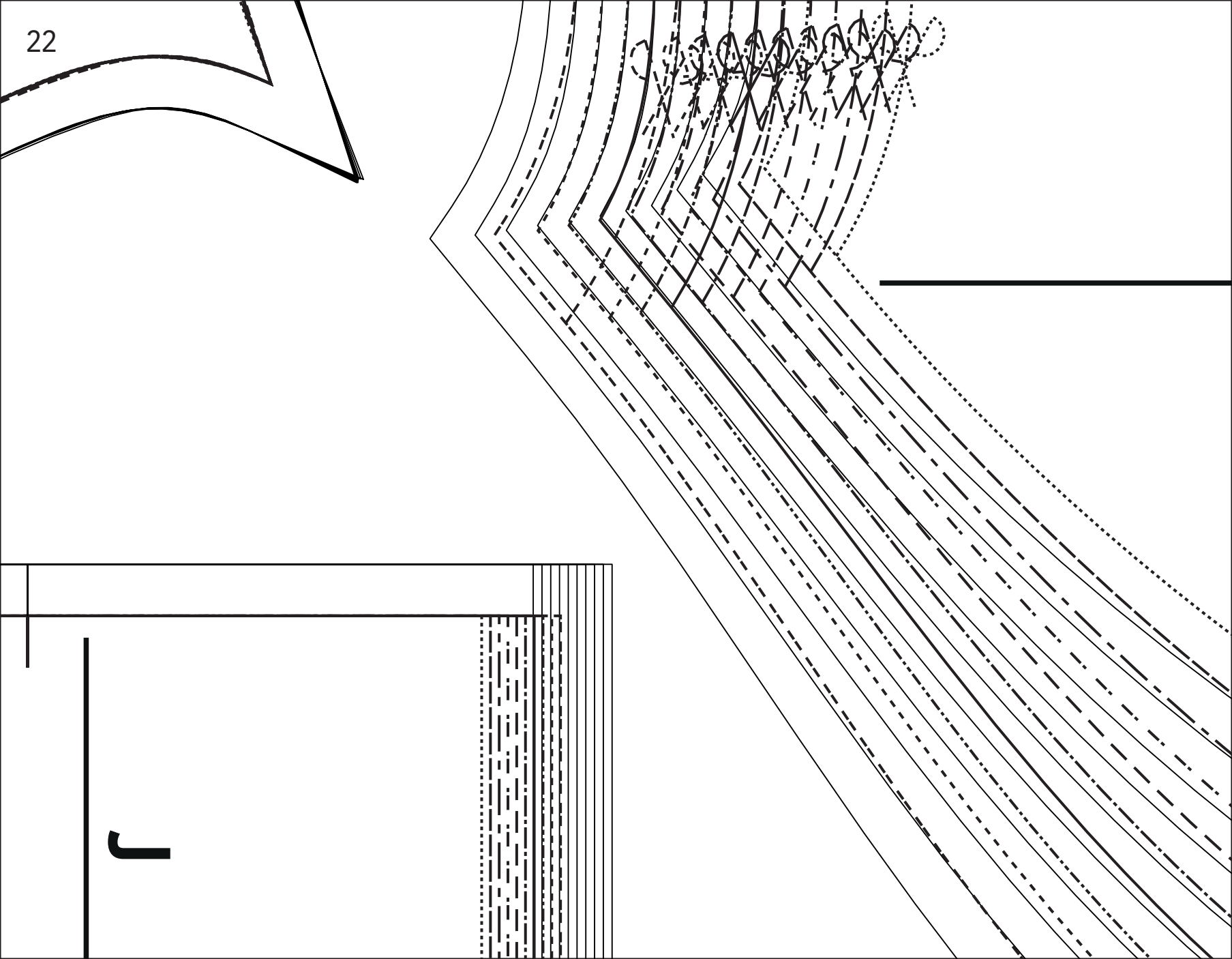

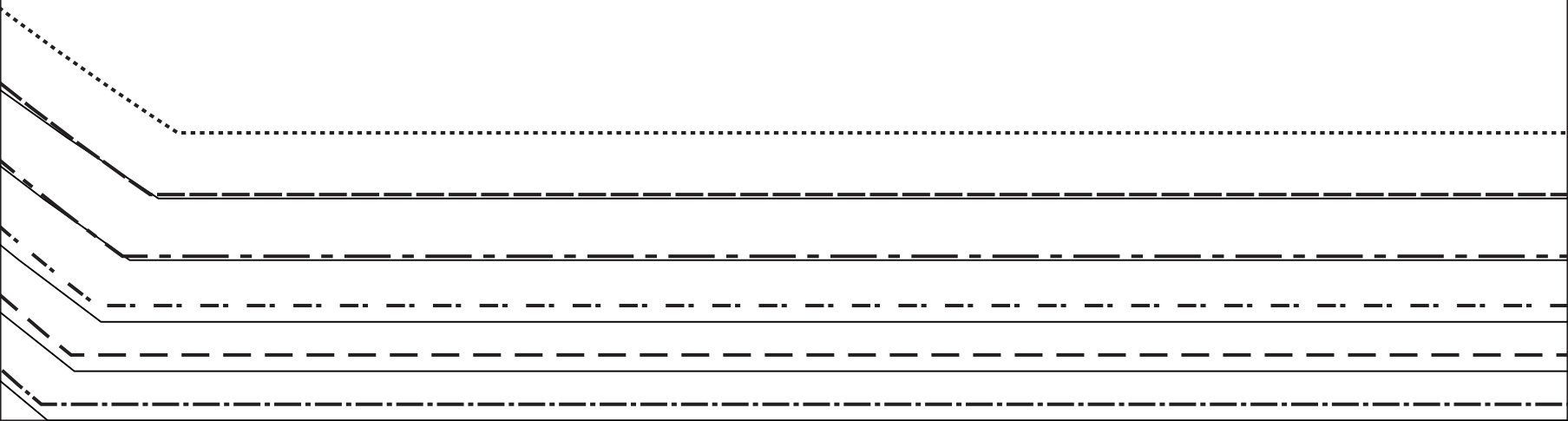
C/C' 

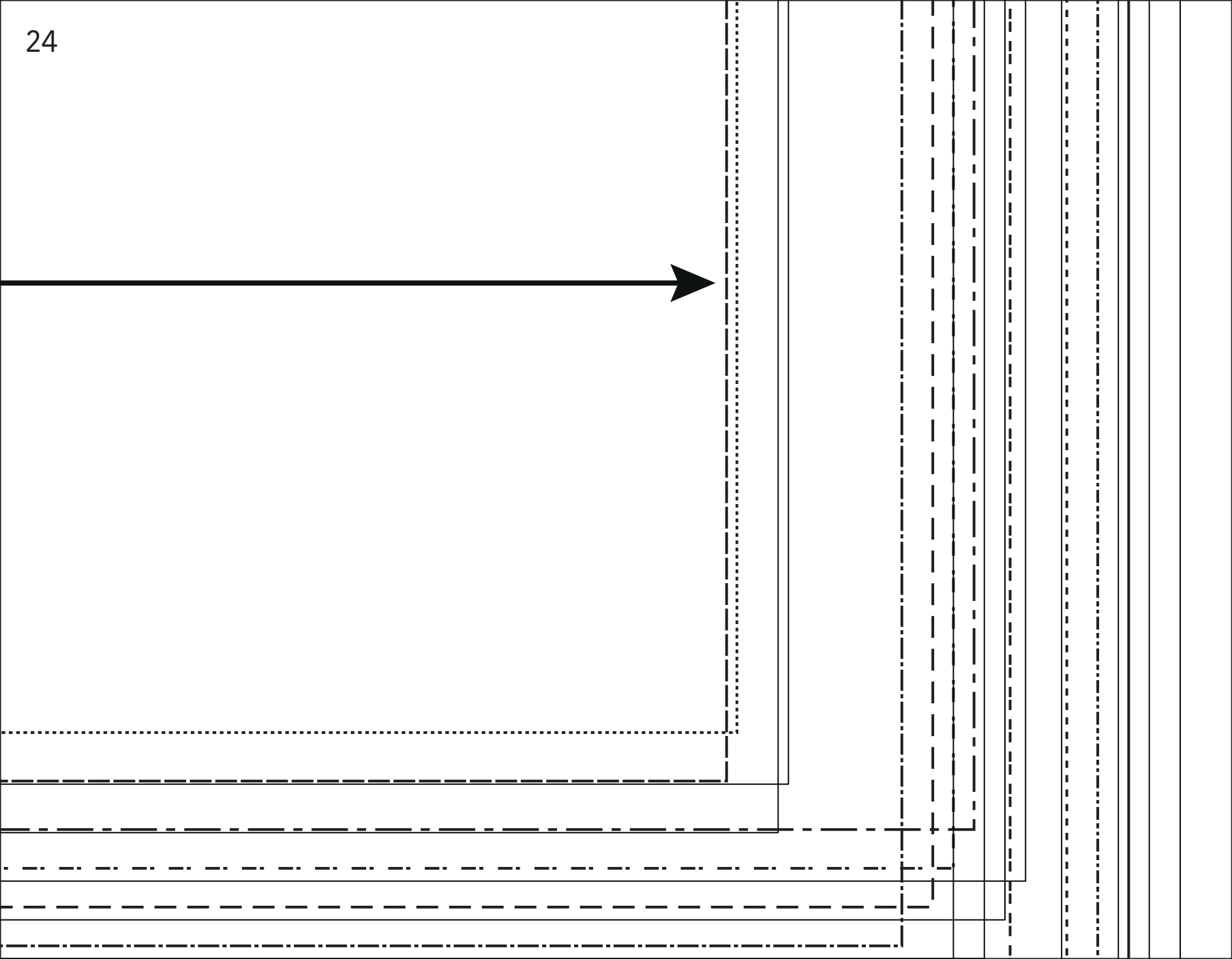

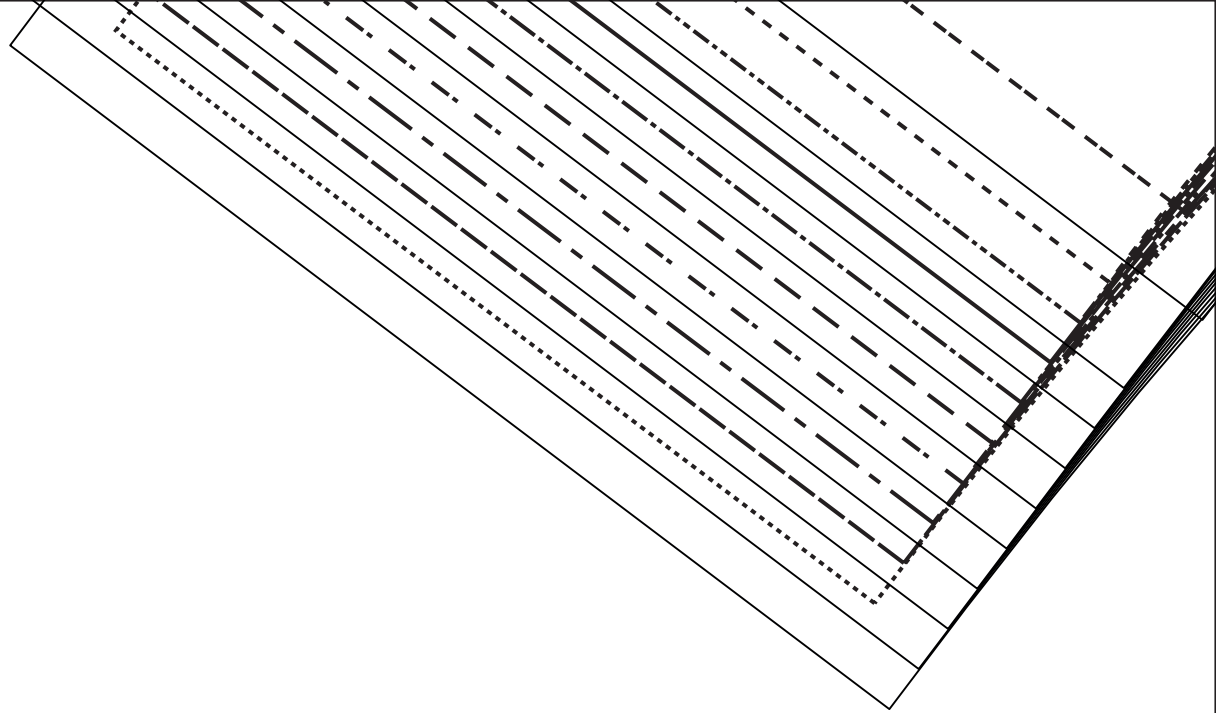

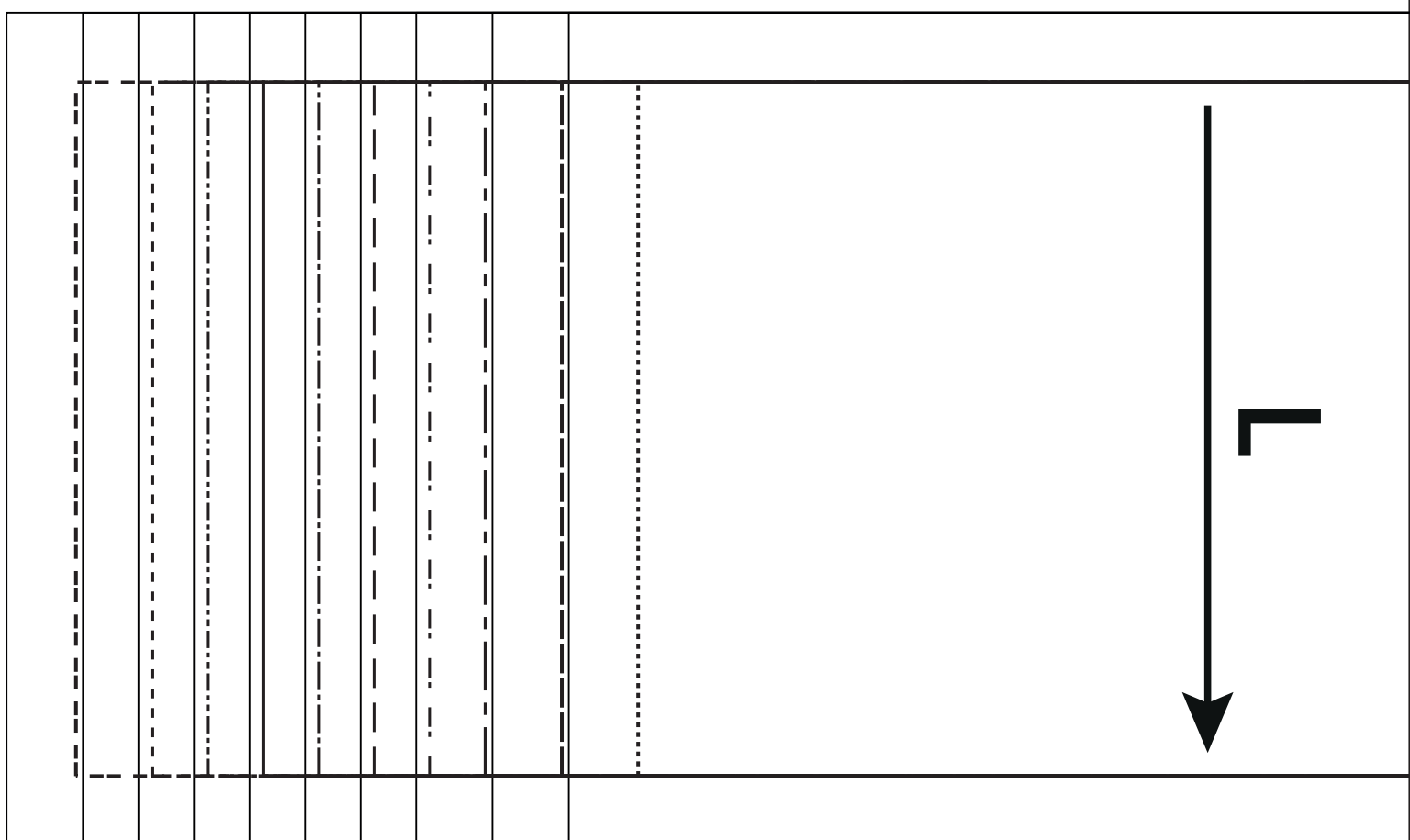
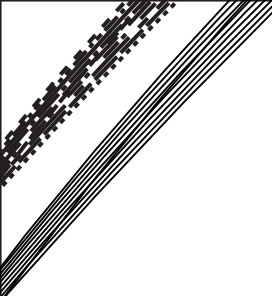

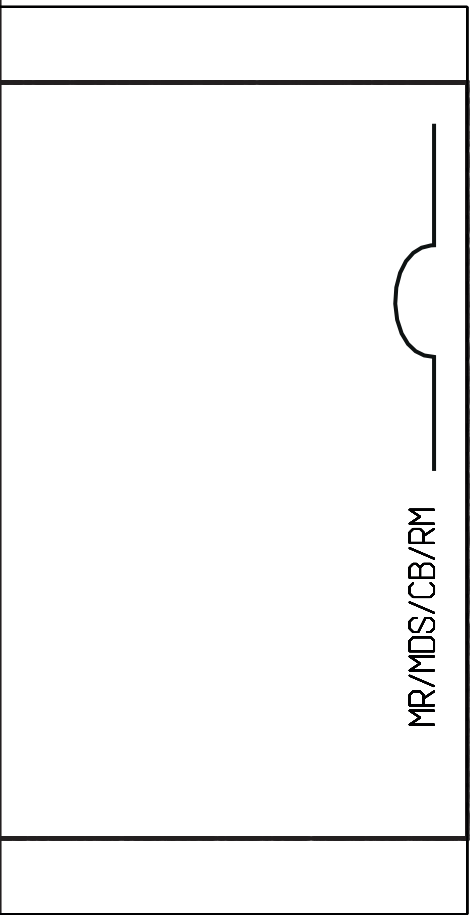
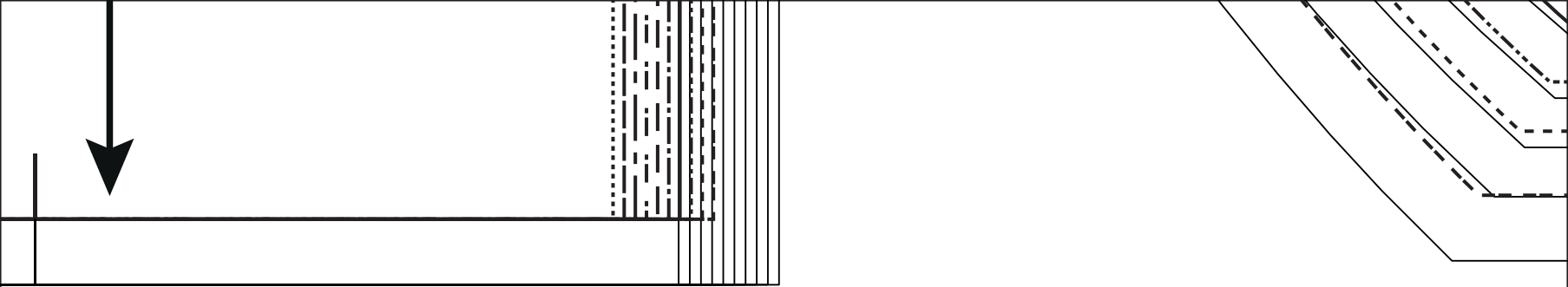

D/D'

