

Elle

Jurk / Robe / Dress / Kleid

Maten / Tailles / Sizes / Größen:

-----	34
- - - - -	36
-----	38
-----	40
=====	42
-----	44
- - - - -	46
-----	48
- - - - -	50
-----	52
-----	54
- - - - -	56

Patroondelen / Pièces du patron / Pattern pieces / Schnittteile:

- A** voorpand / devant / front panel /
Vorderteil
- B** rugpand / dos / back panel /
Rückenteil
- C** mouw / manche / sleeve / Ärmel
- D** beleg VP / parementure DV /
facing FP / Besatz VT
- E** beleg RP / parementure DS /
facing BP / Besatz RT
- F** kraag / col / collar / Kragen
- G** zak / poche / pocket / Tasche

Patroonschema / Schéma du Patron / Pattern Diagram / Übersichtsplan zum Zusammenkleben

1	2	3	4	5	6	7
8	9	10	11	12	13	14
15	16	17	18	19	20	21
22	23	24	25	26	27	28
29	30	31	32	33	34	35
36	37	38	39	40	41	42
43	44	45	46	47	48	49
50	51	52	53	54	55	56

Controlevierkant / Carré de controle
/ Test square / Kontrollquadrat

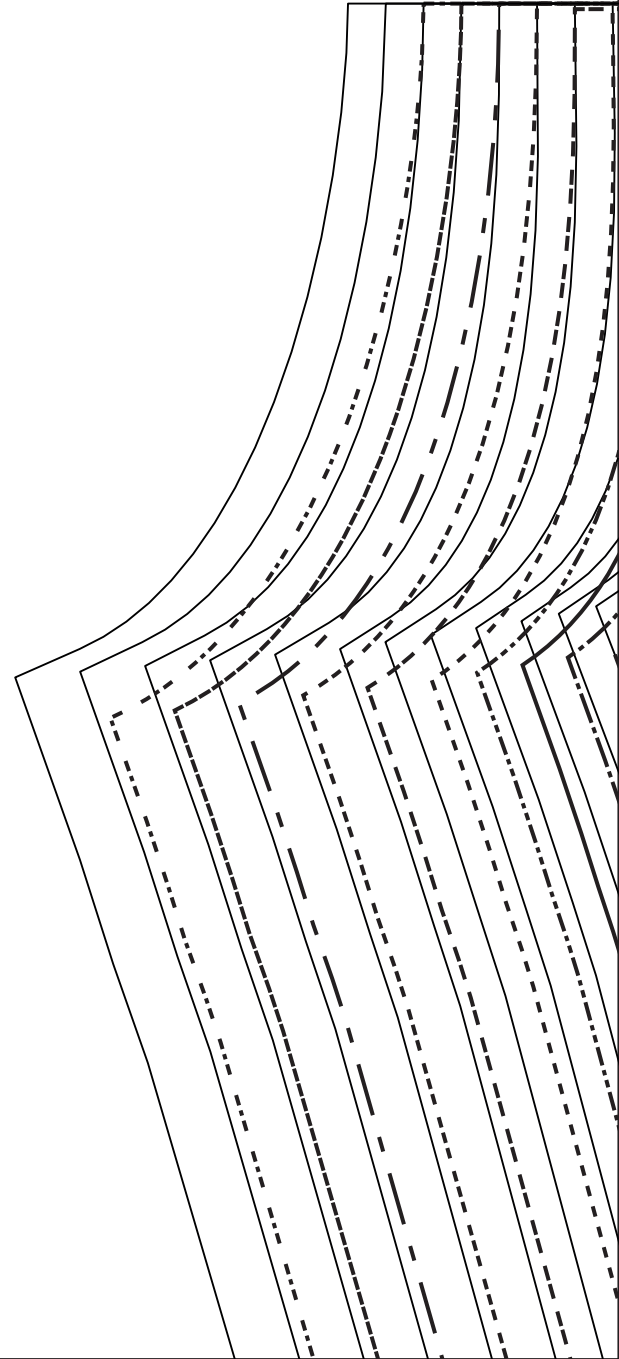
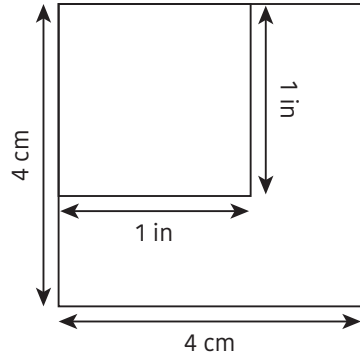

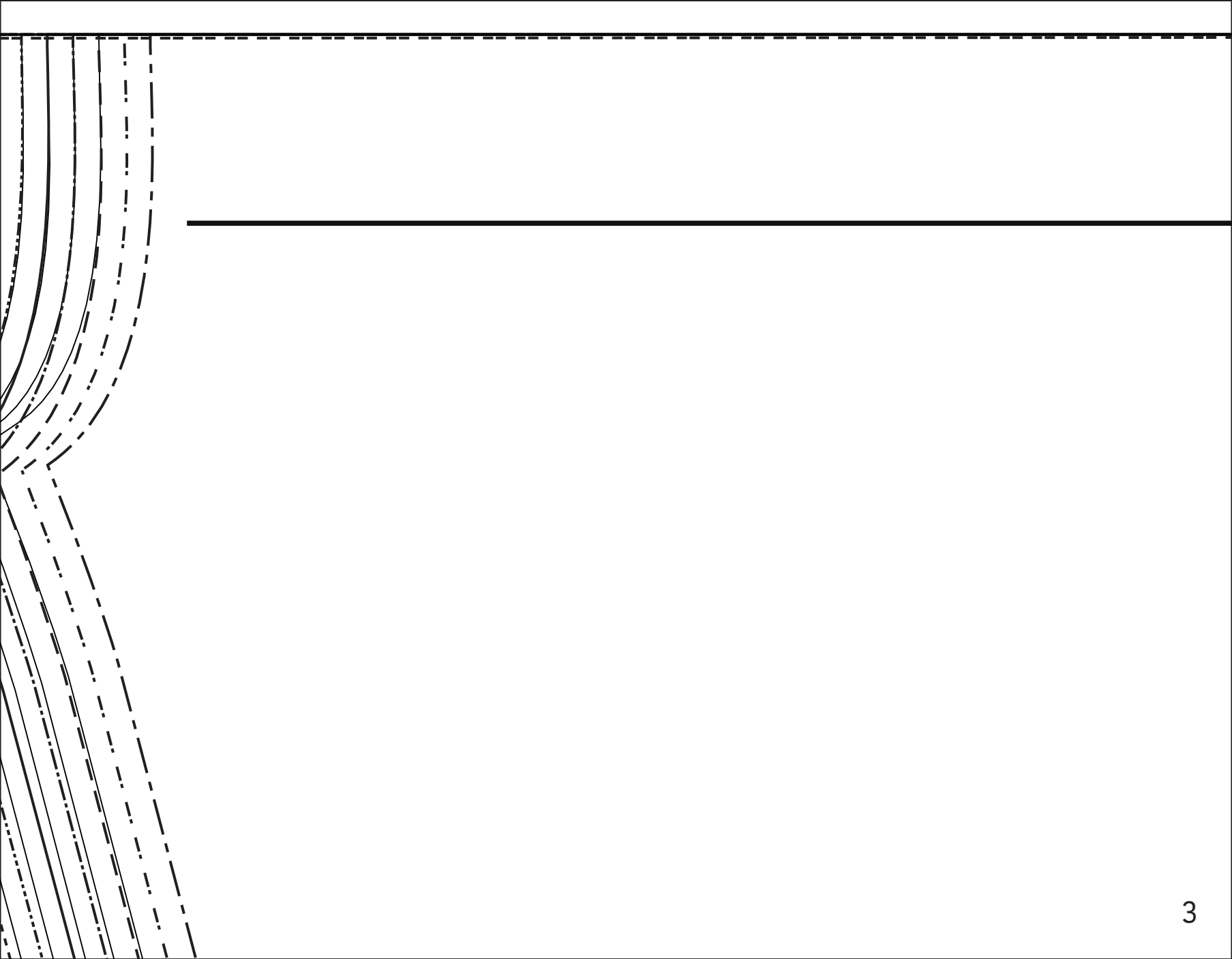

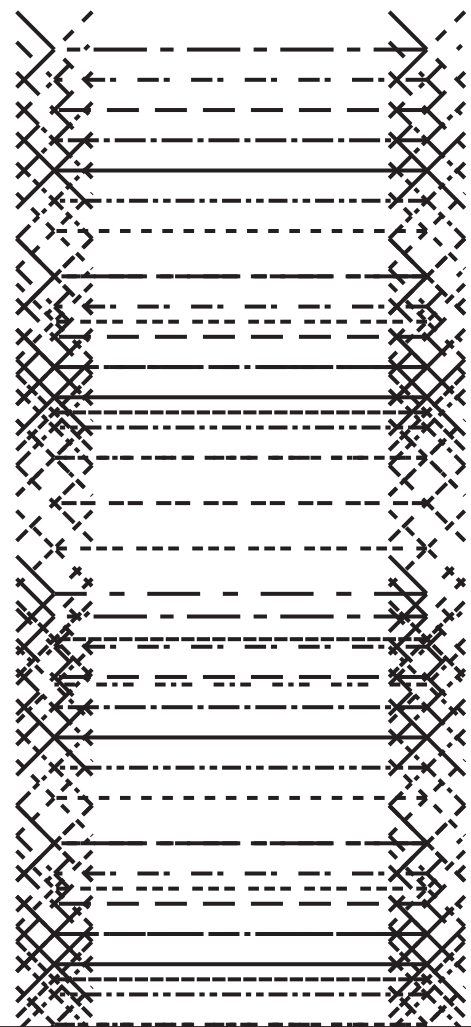
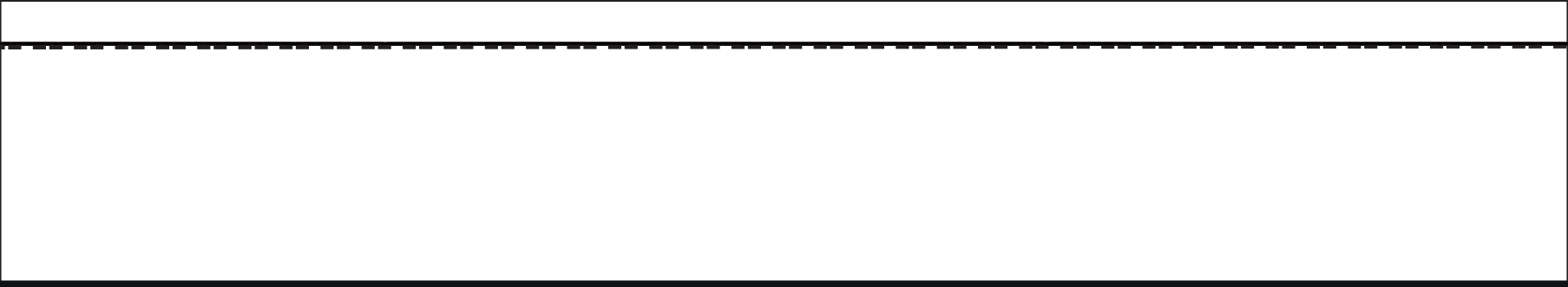



B

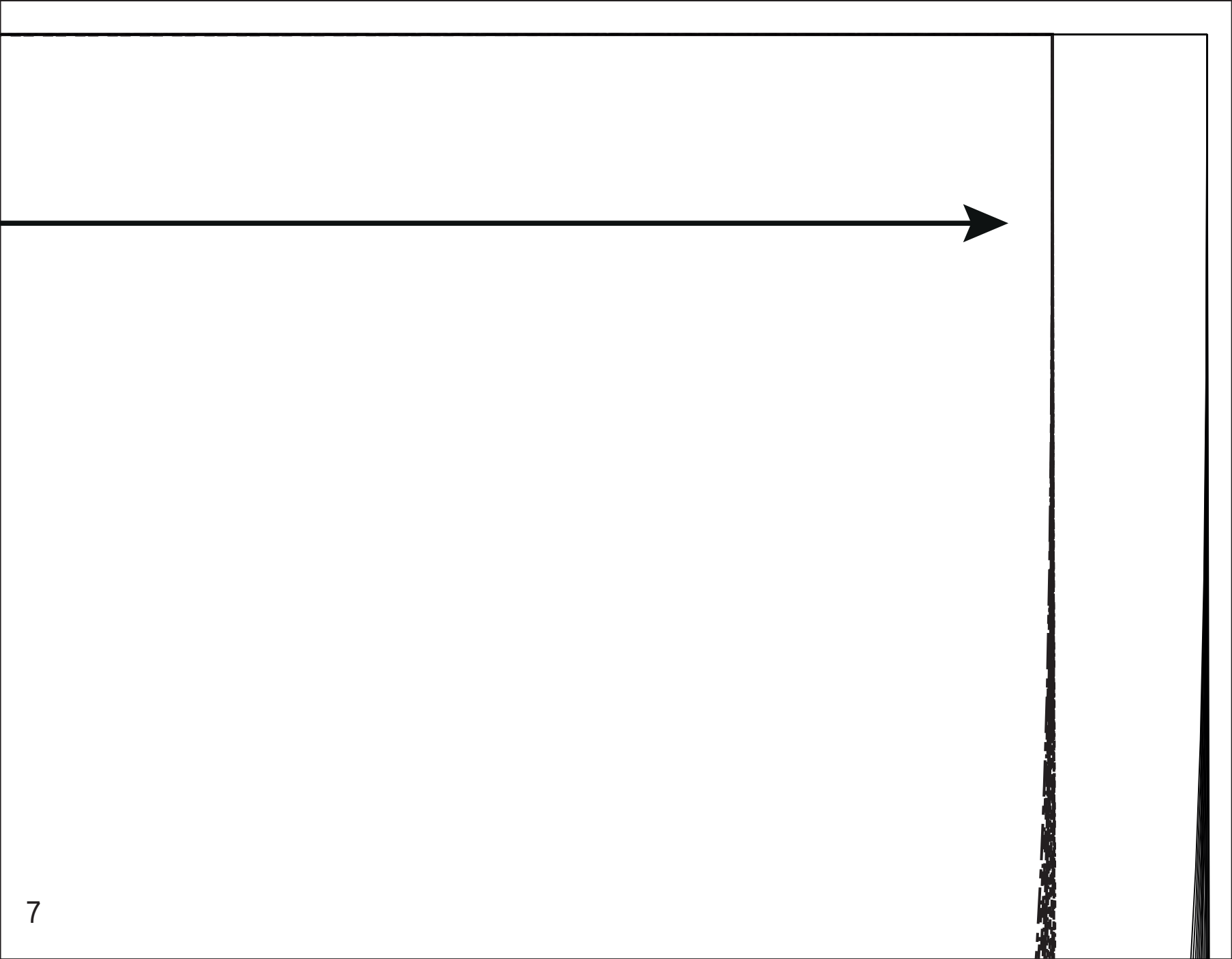

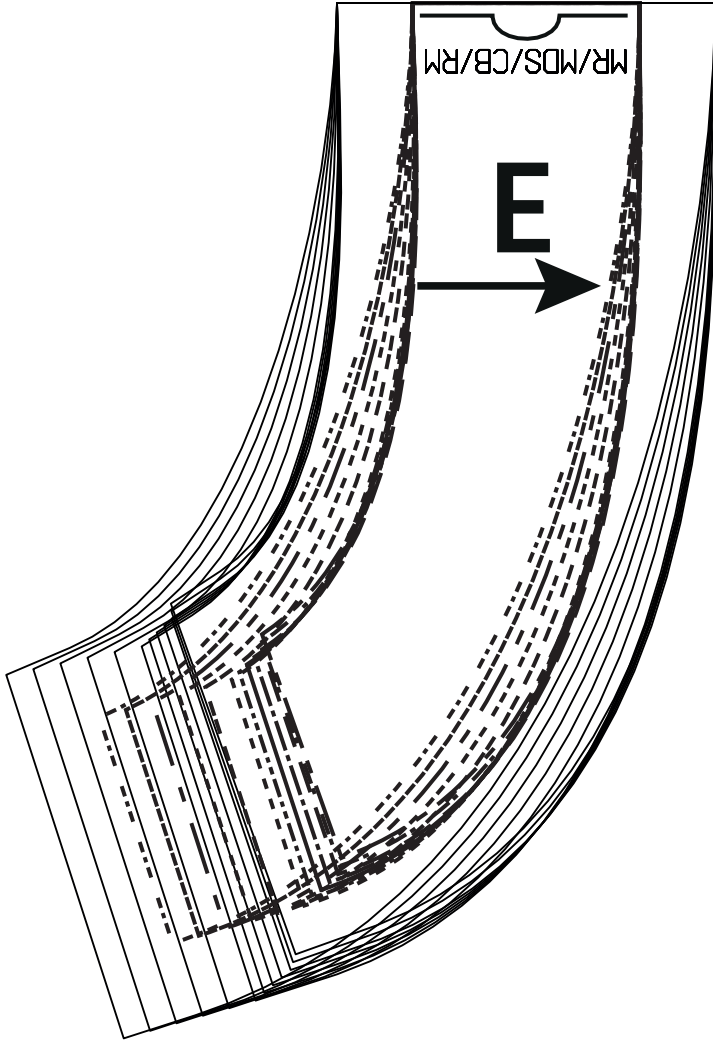

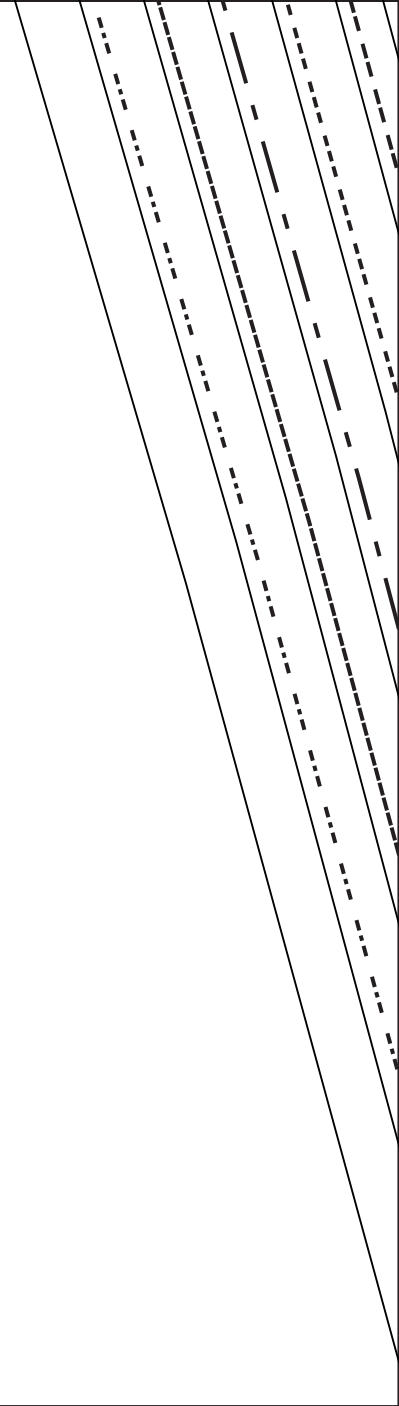

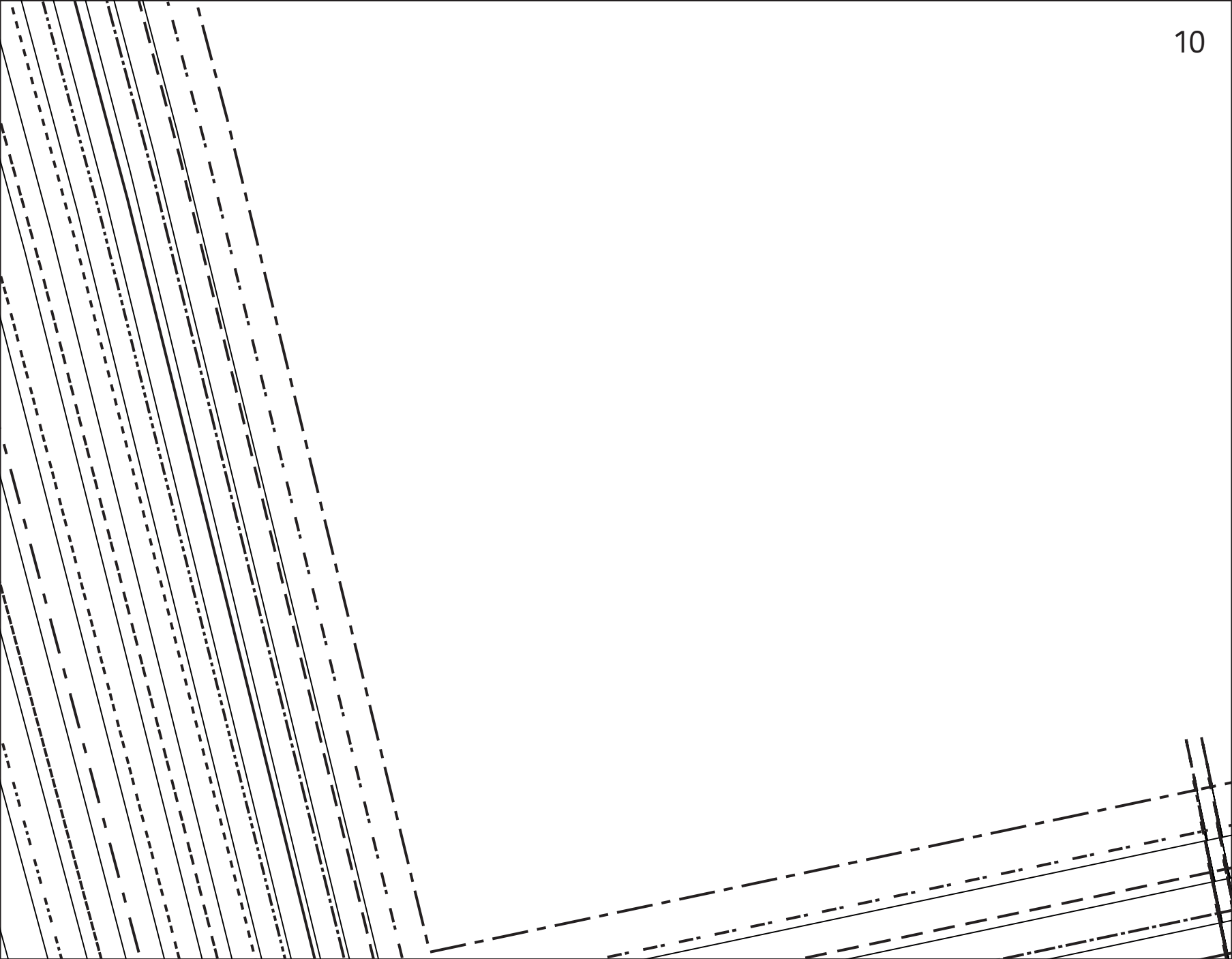

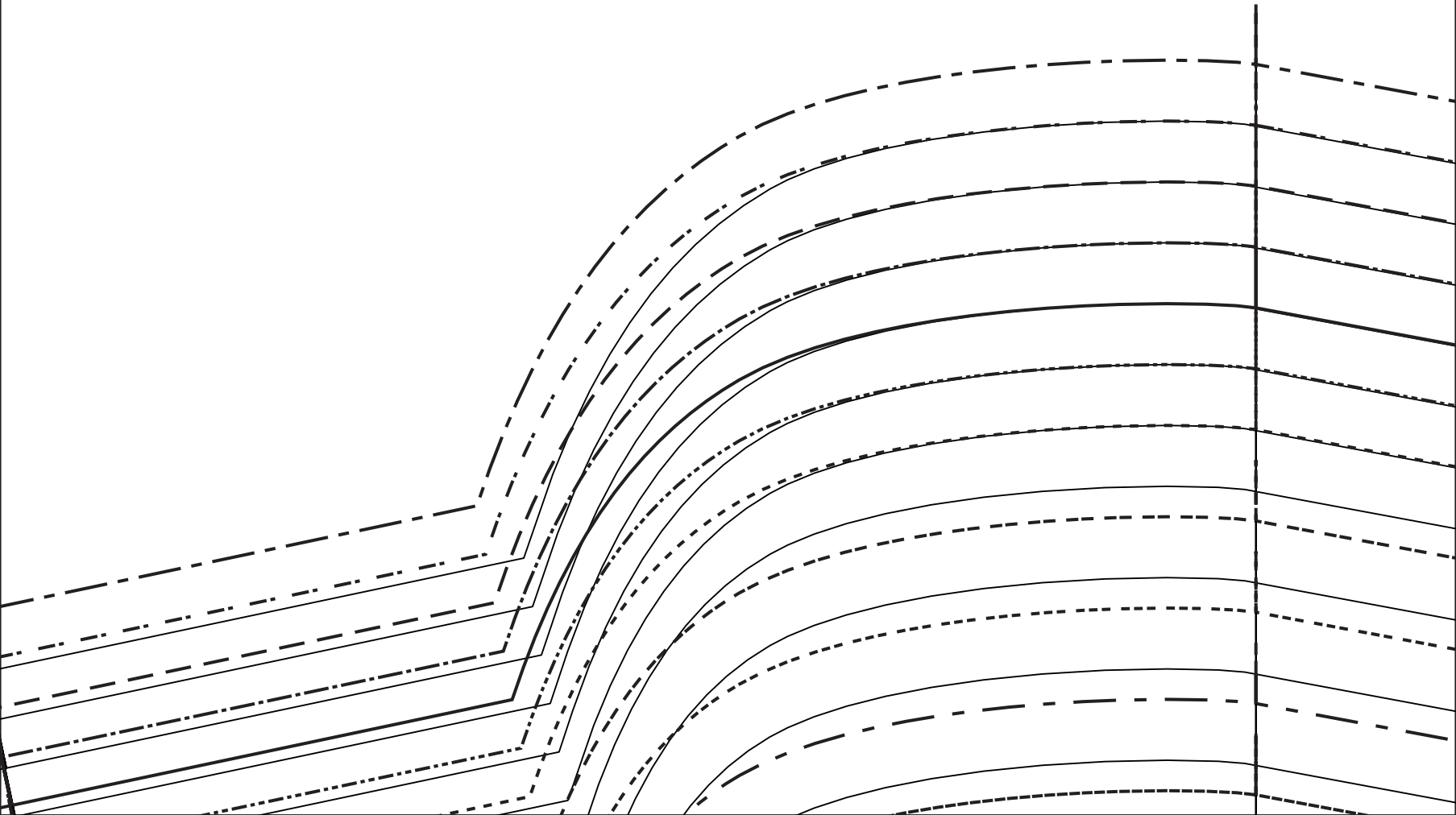
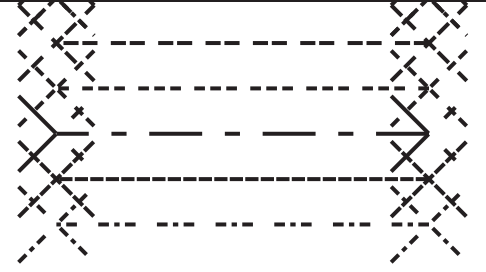

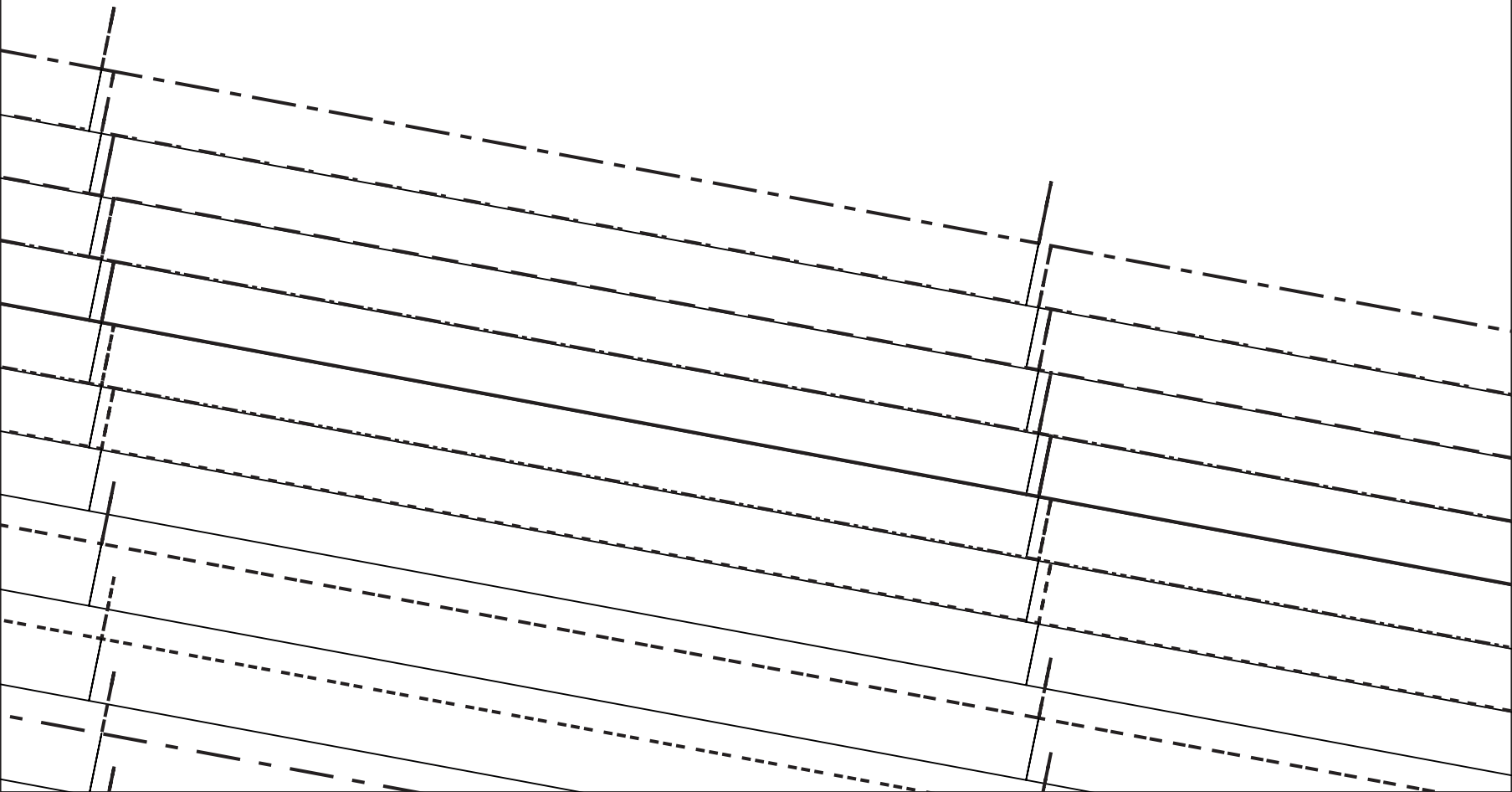

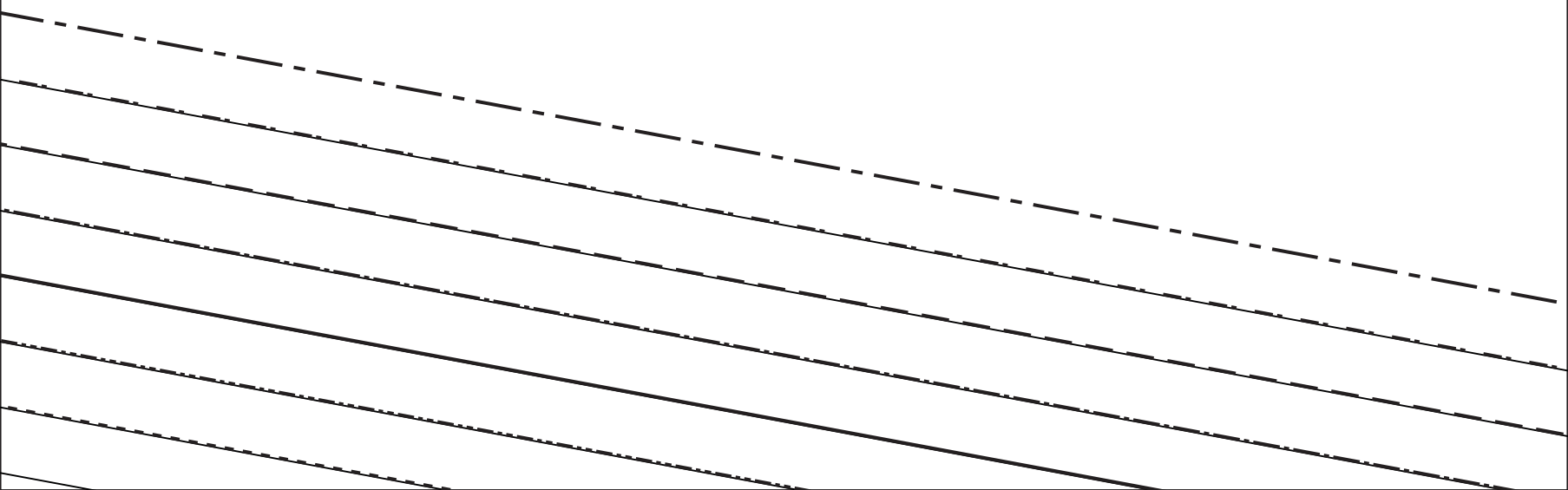

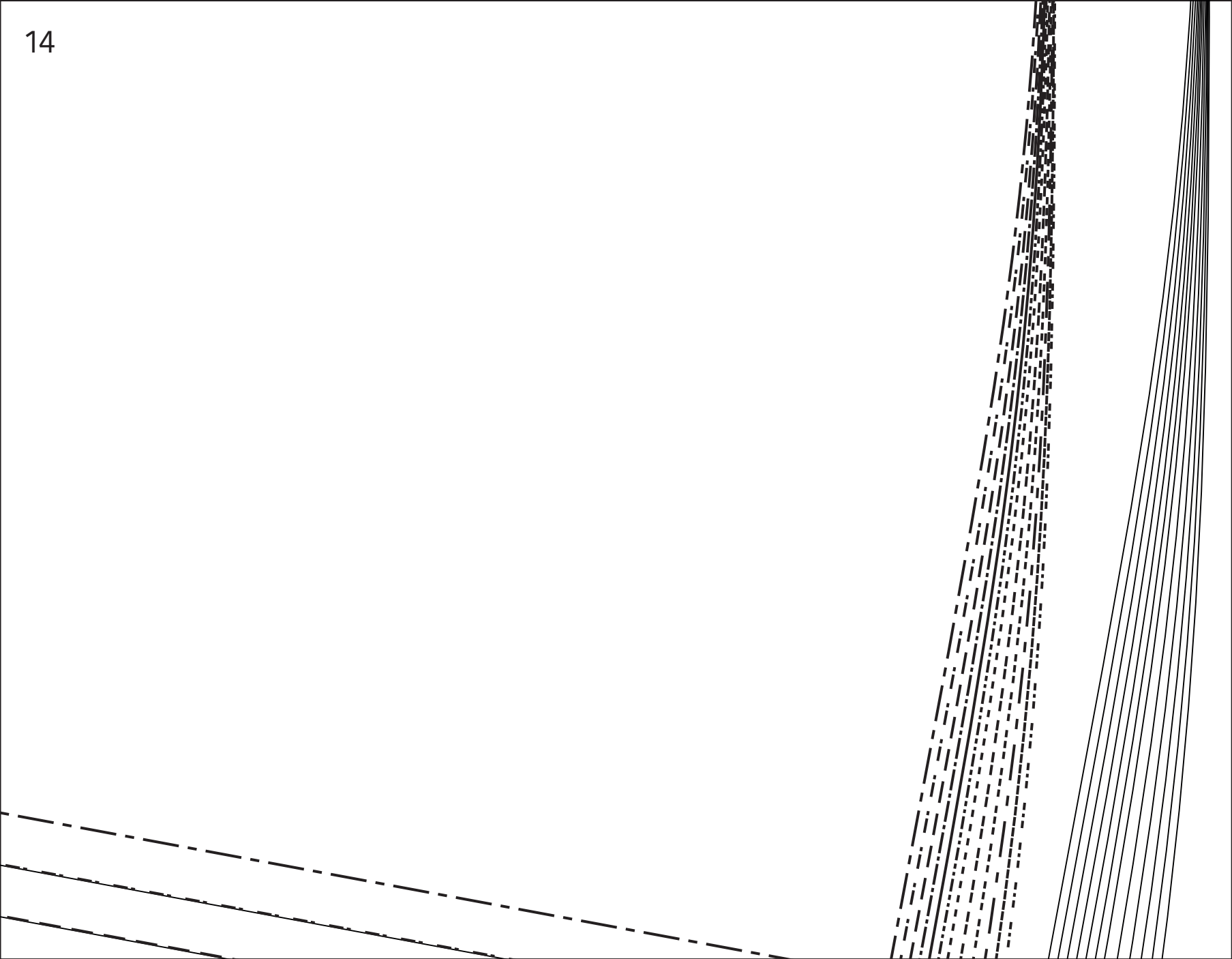

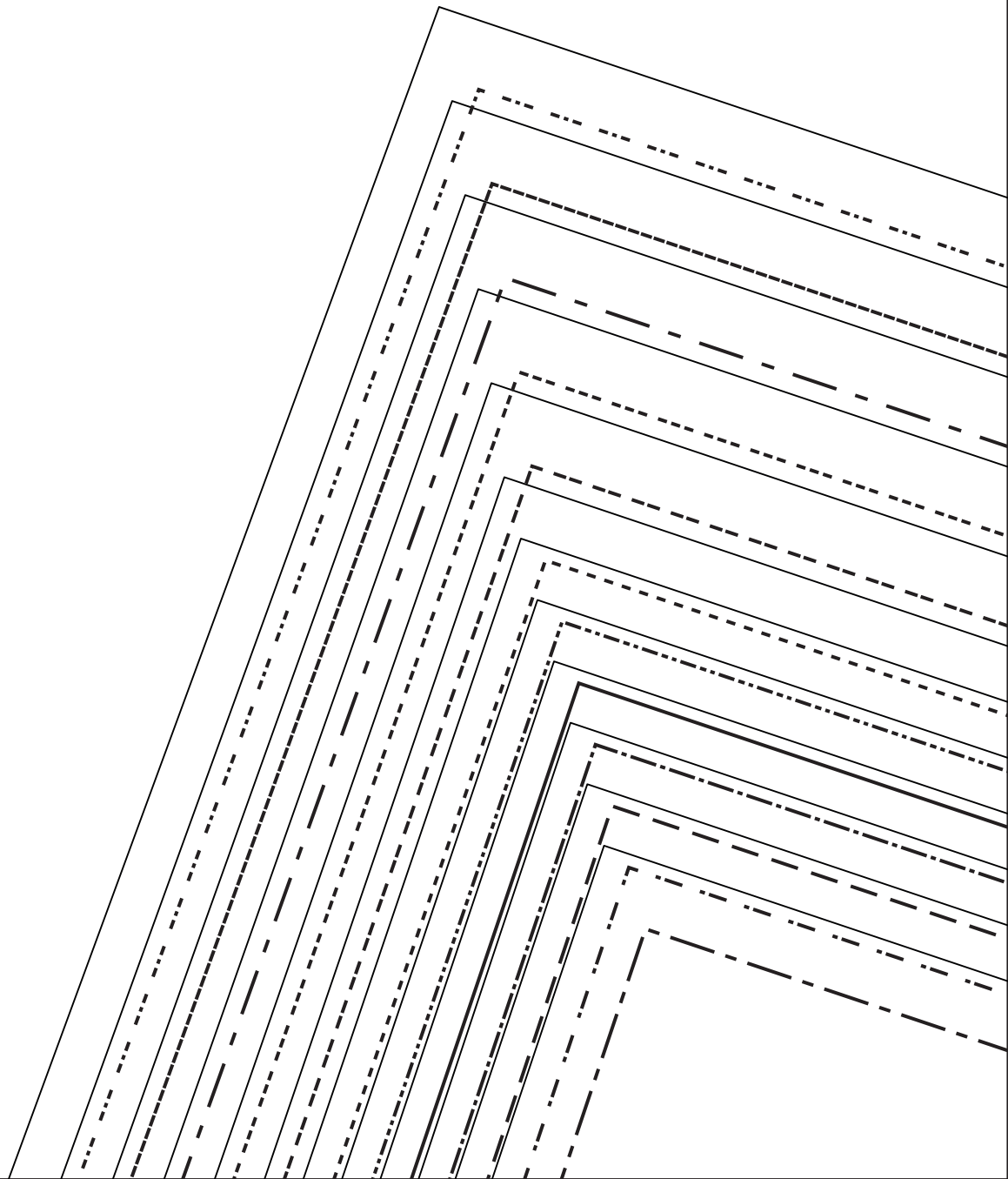

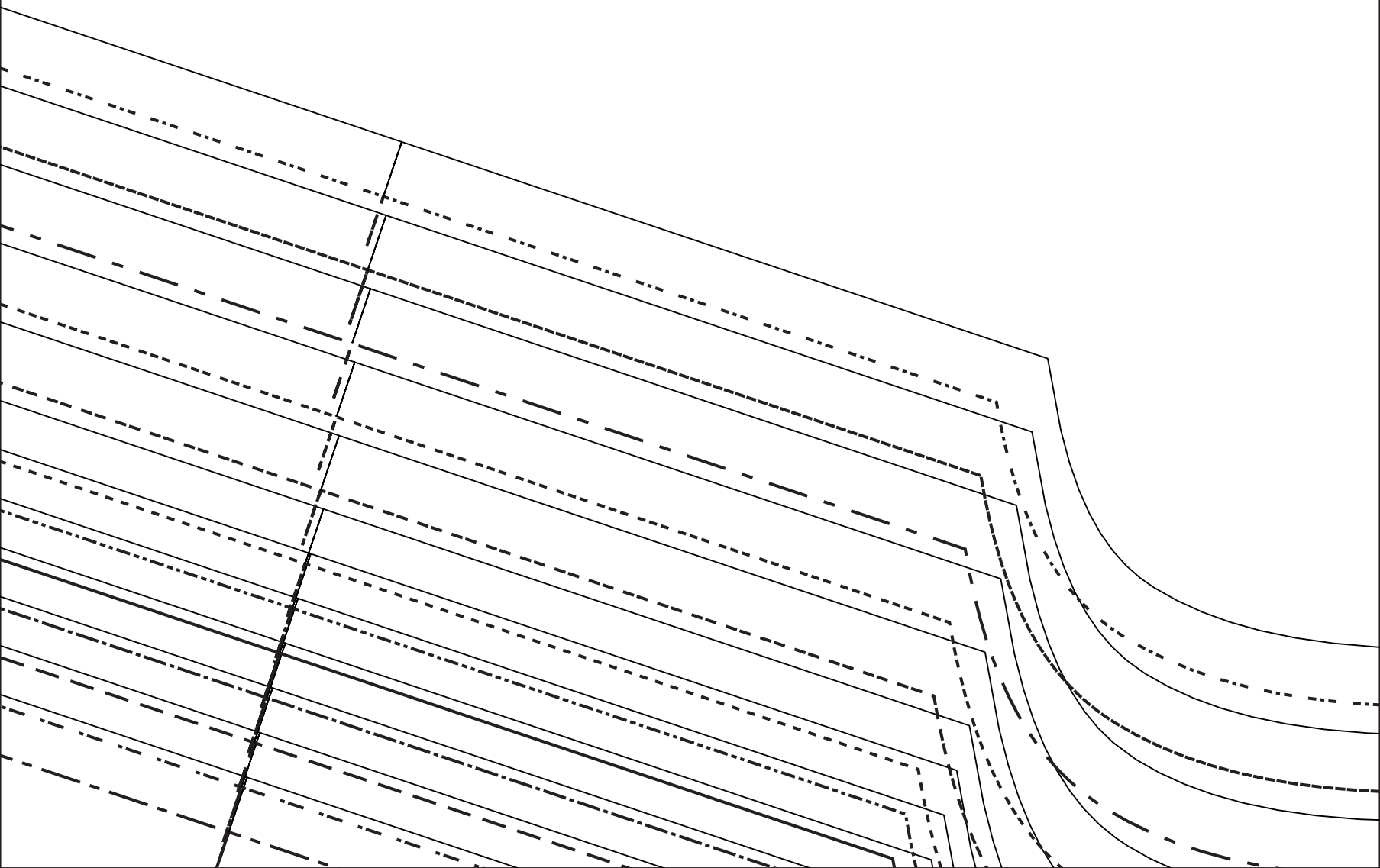

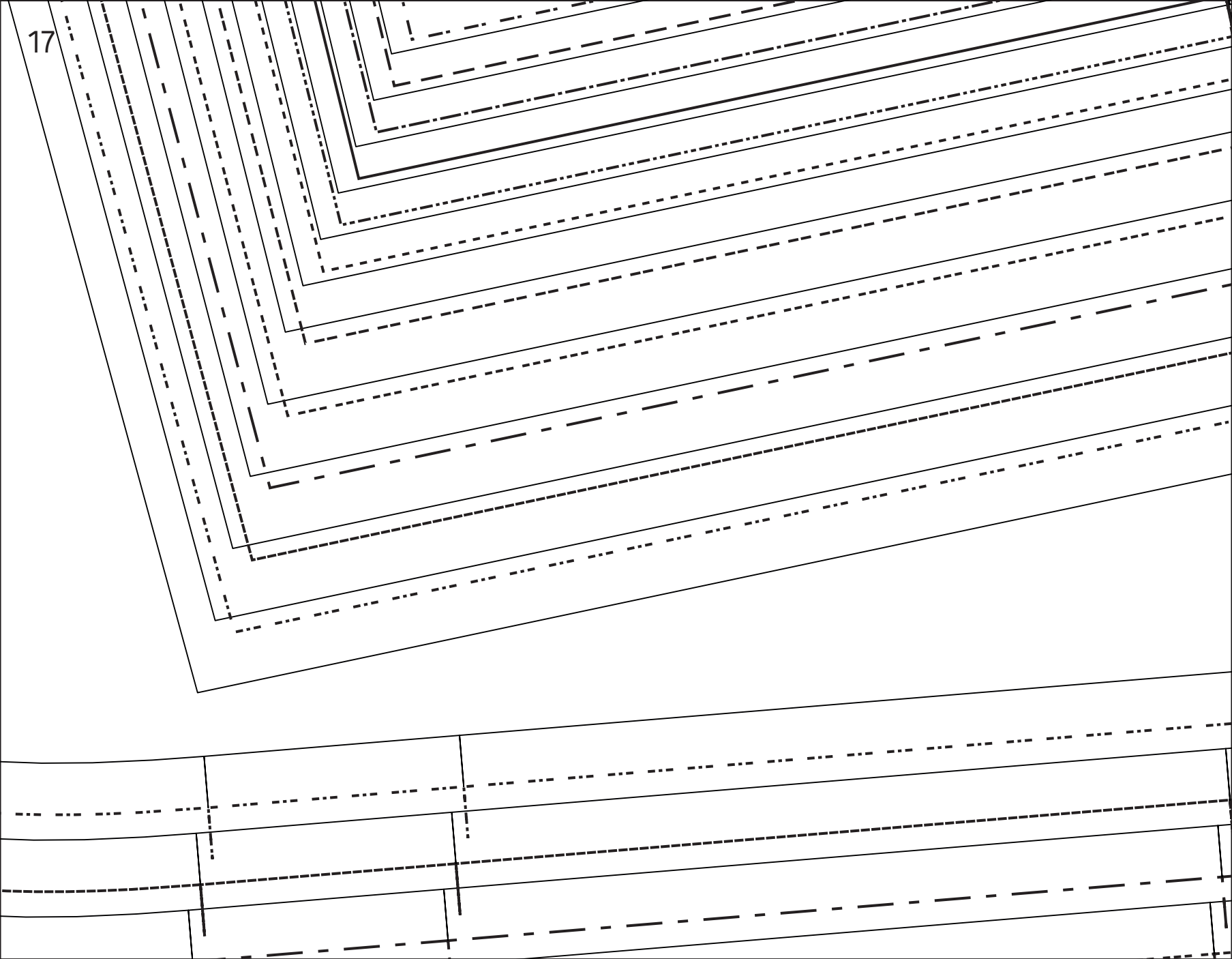

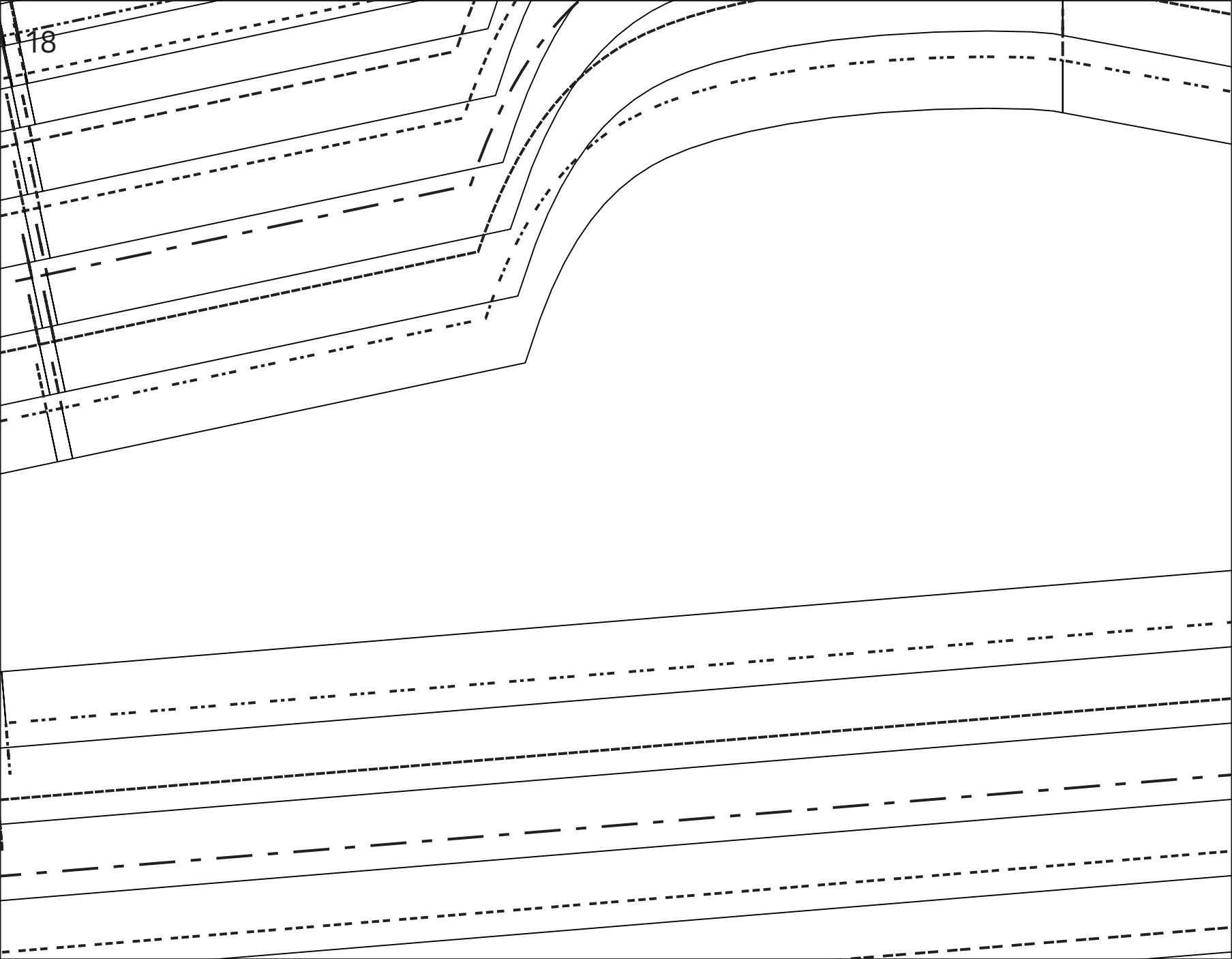

18

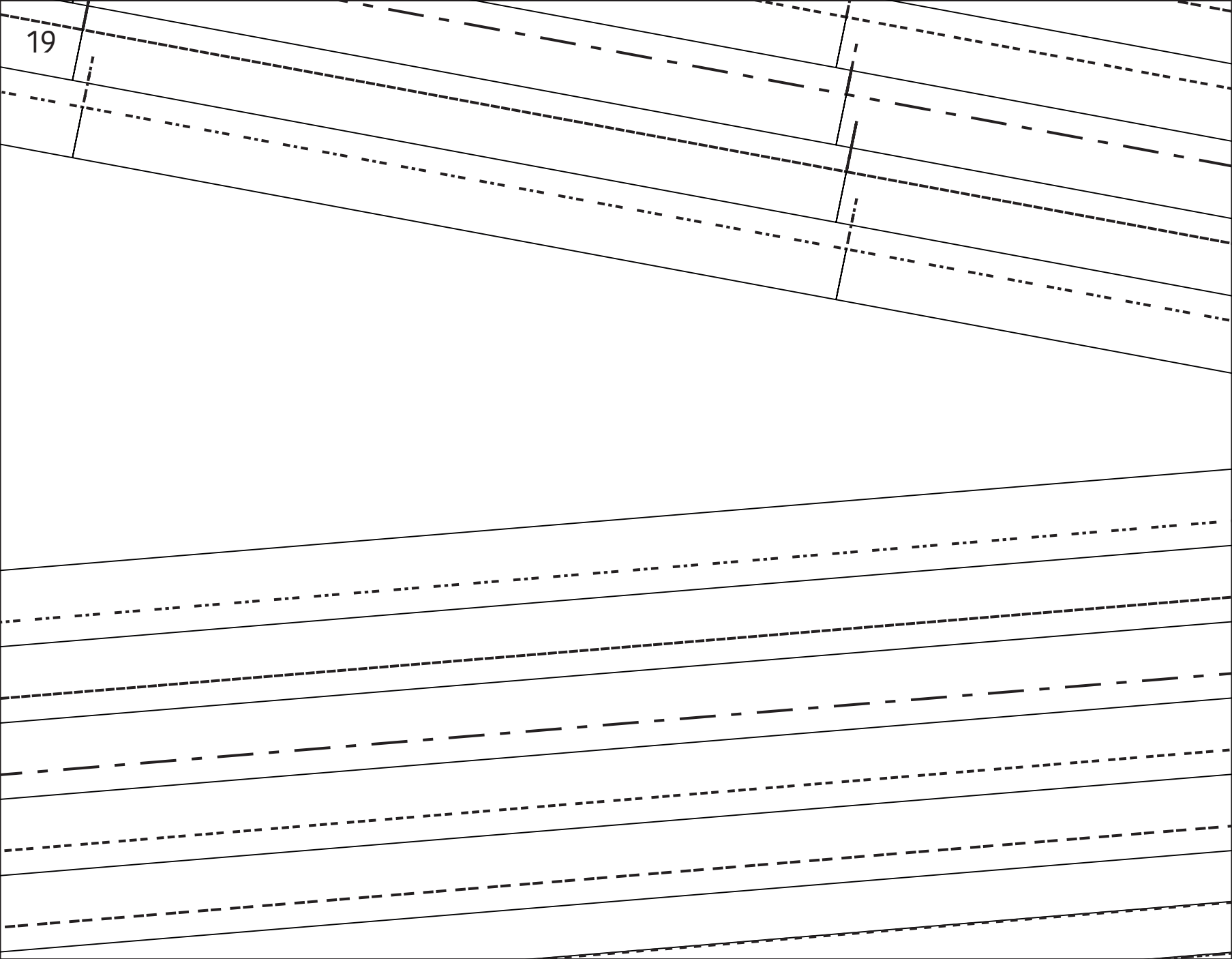

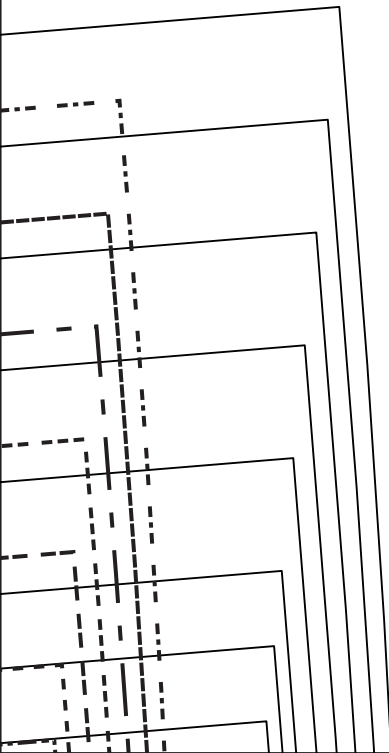
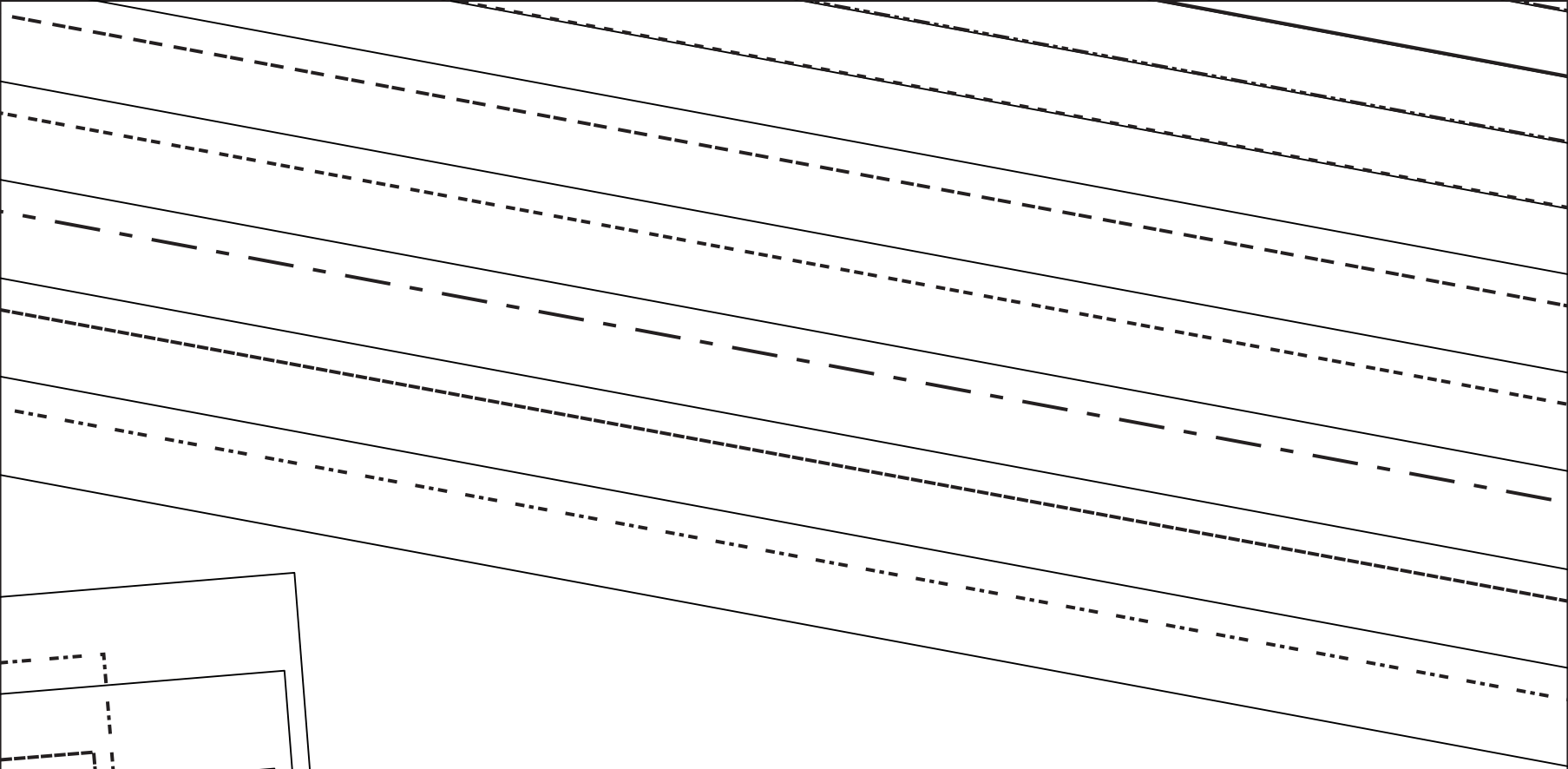

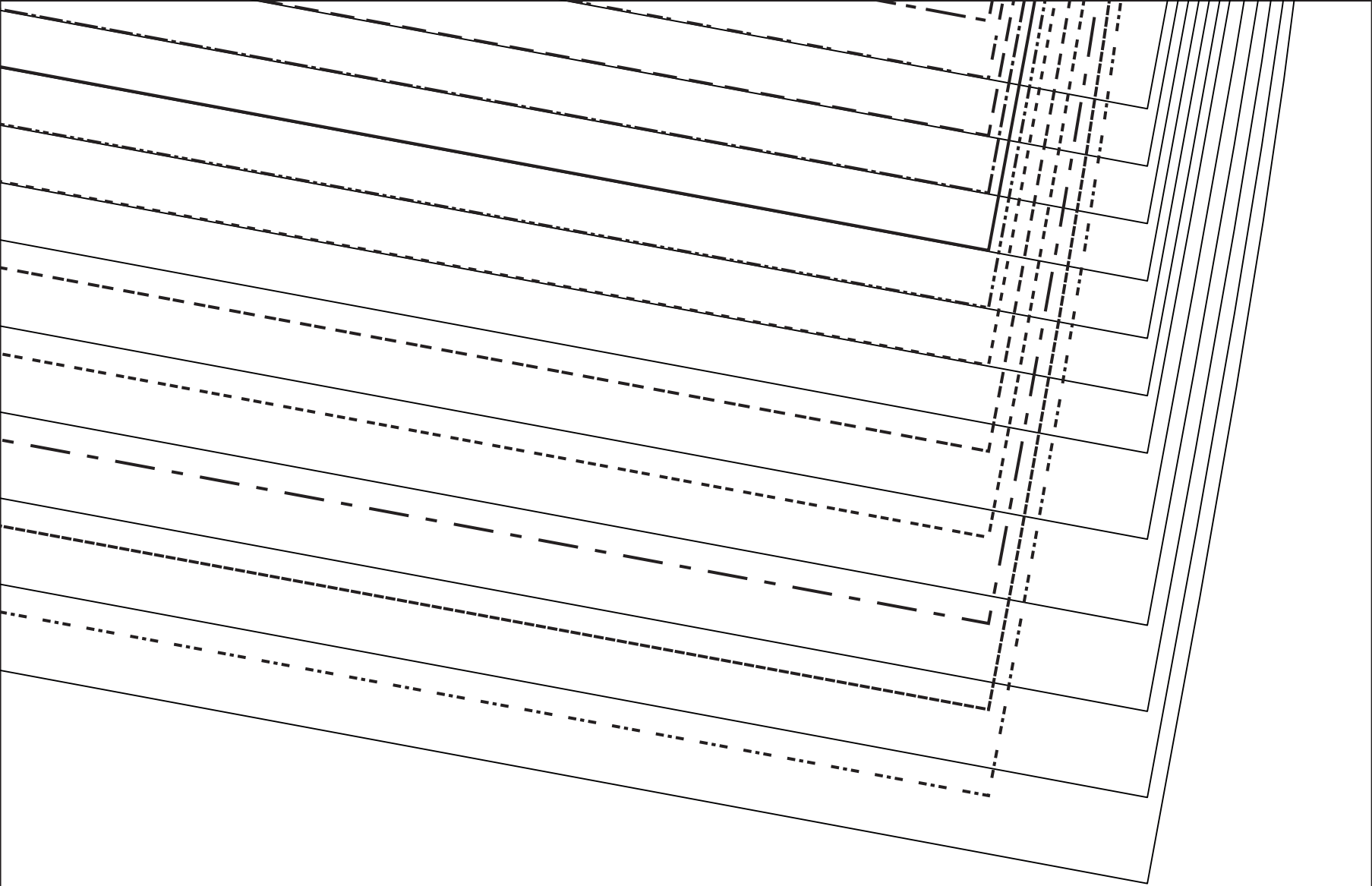

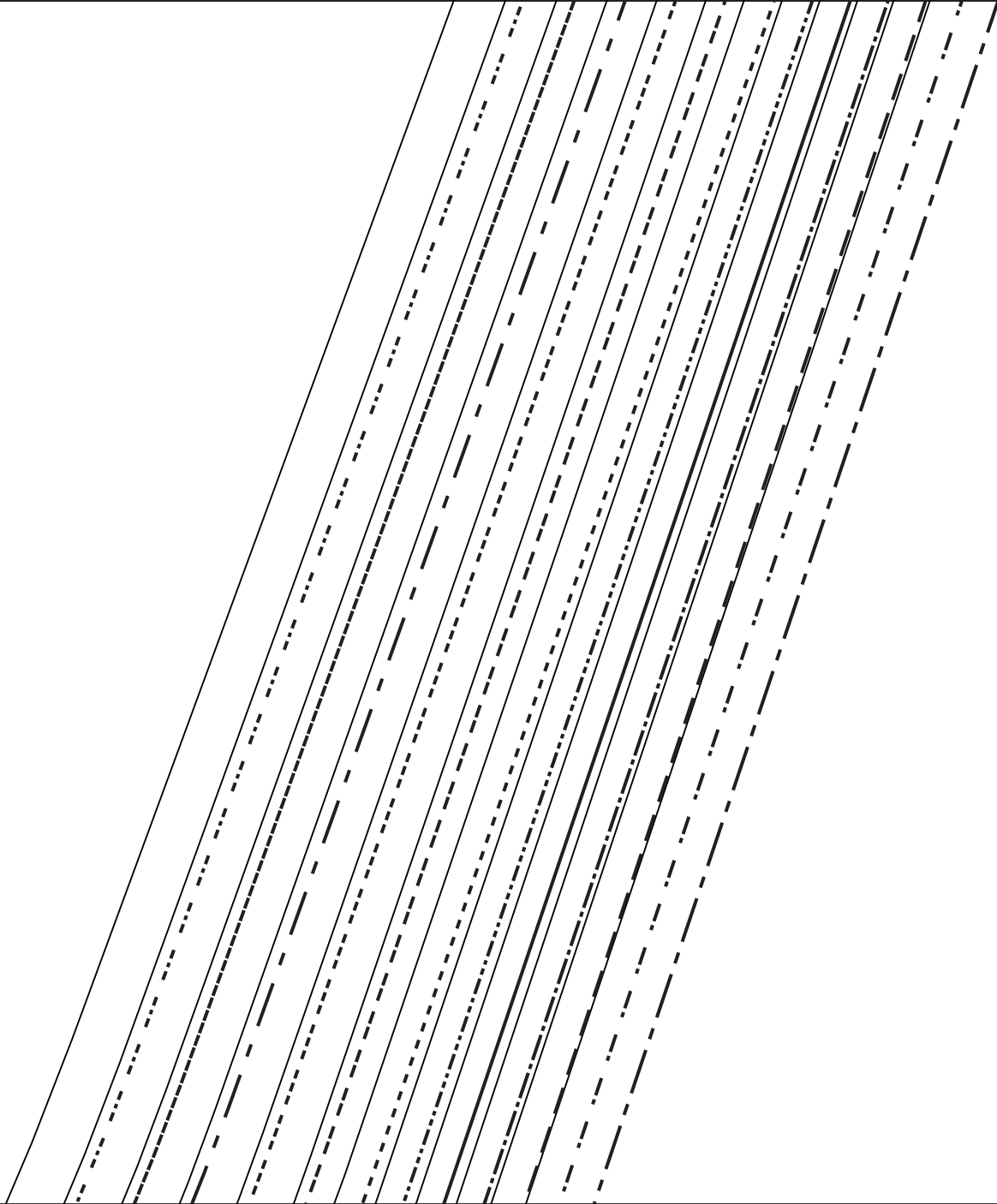

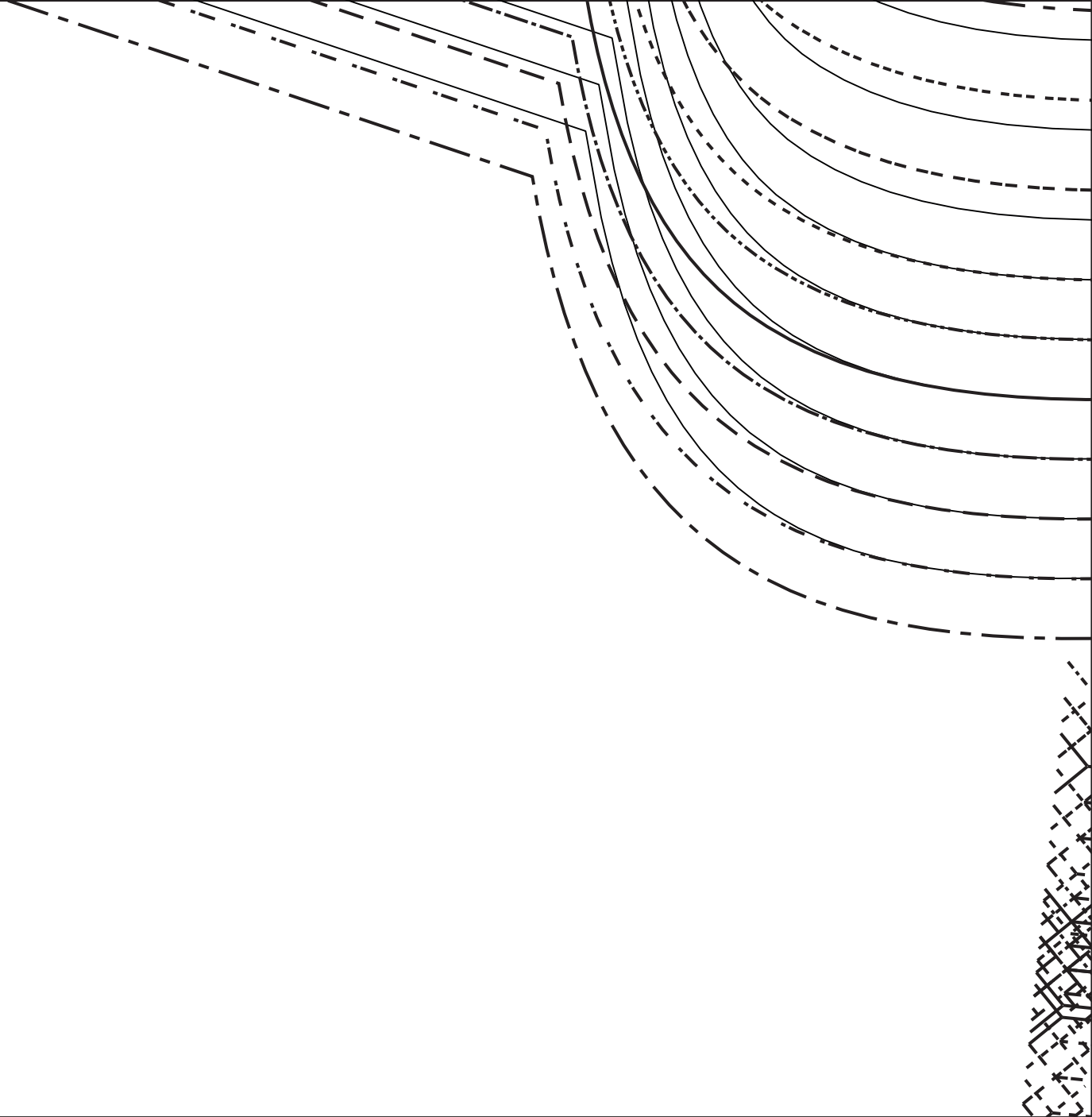

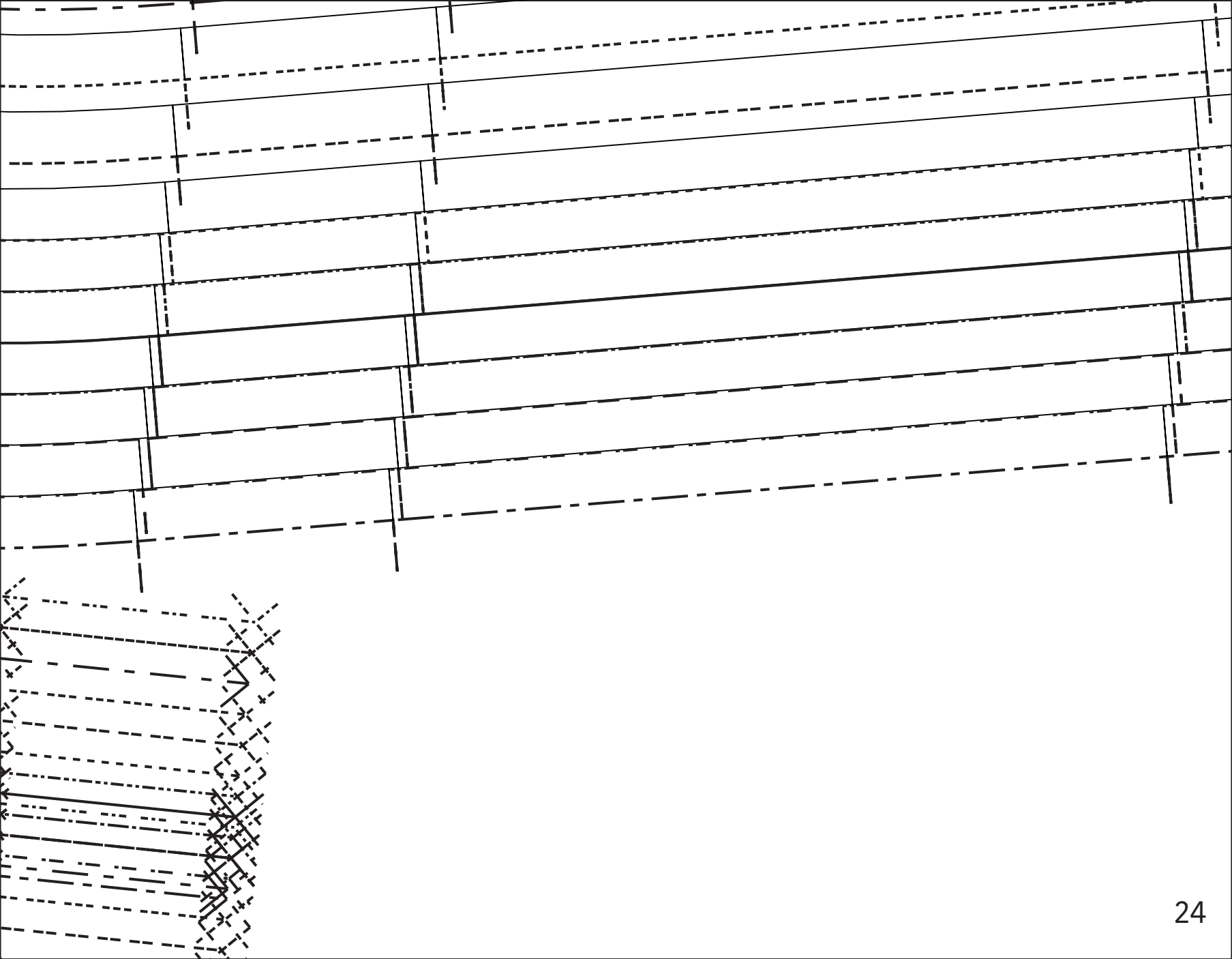

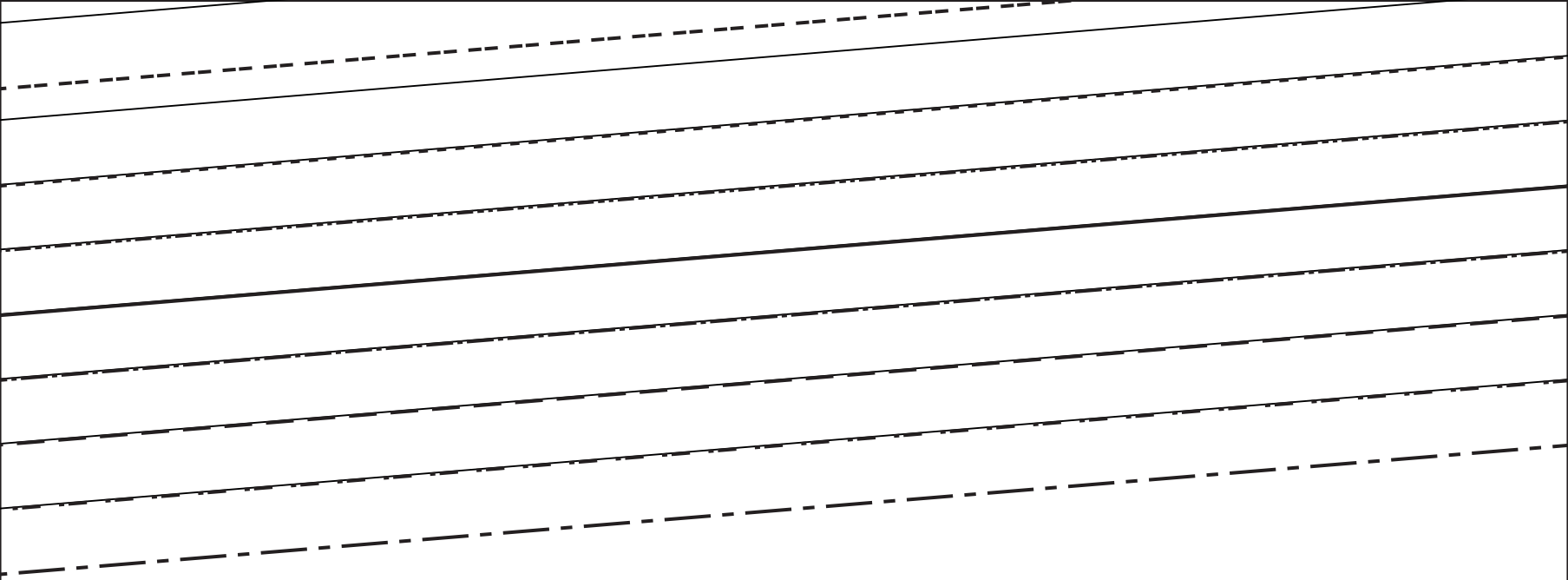

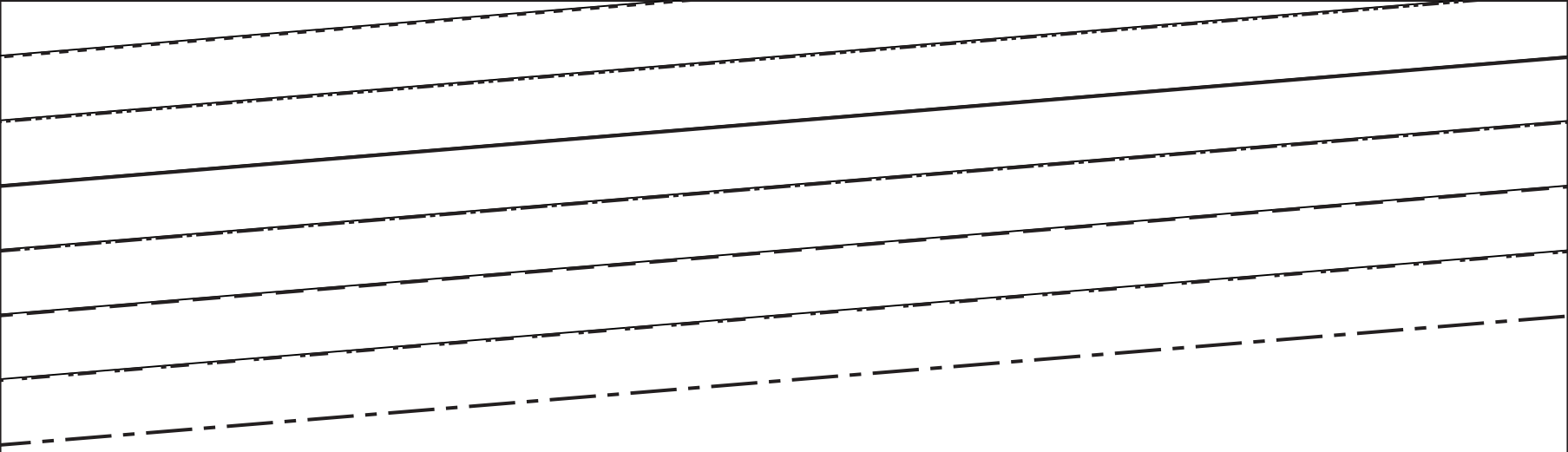

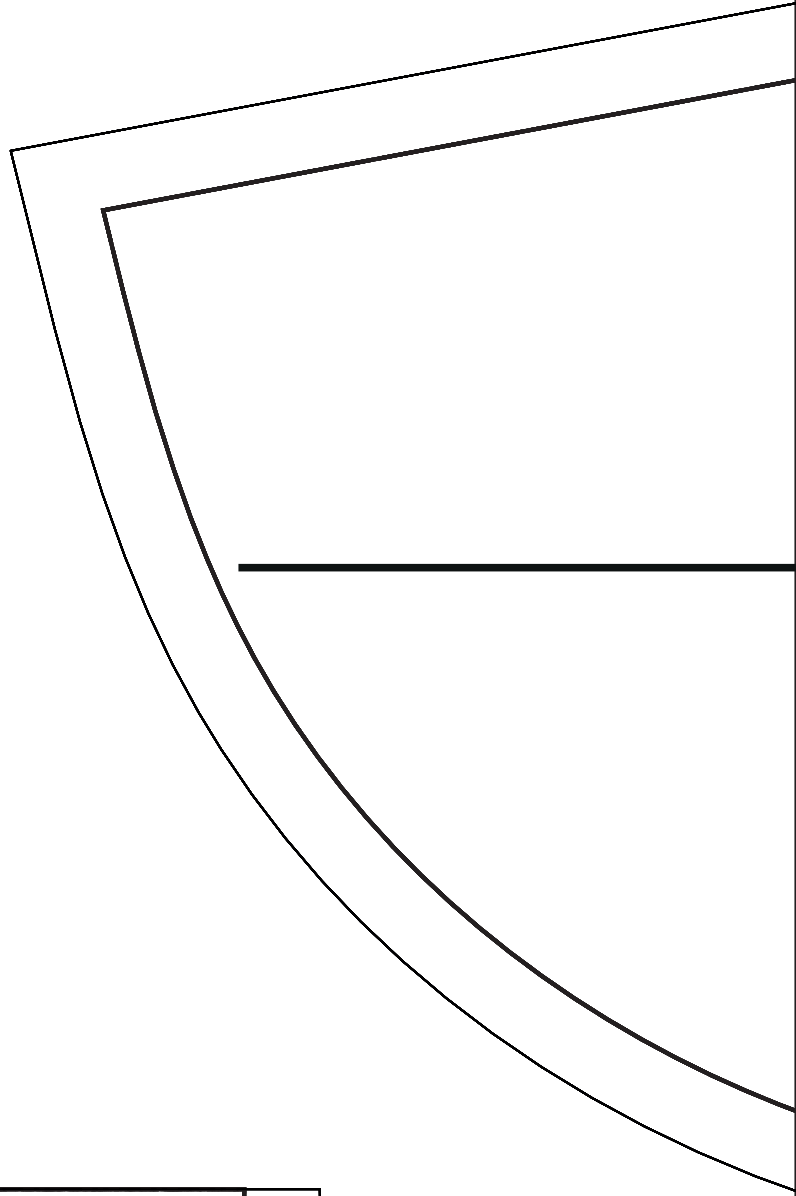
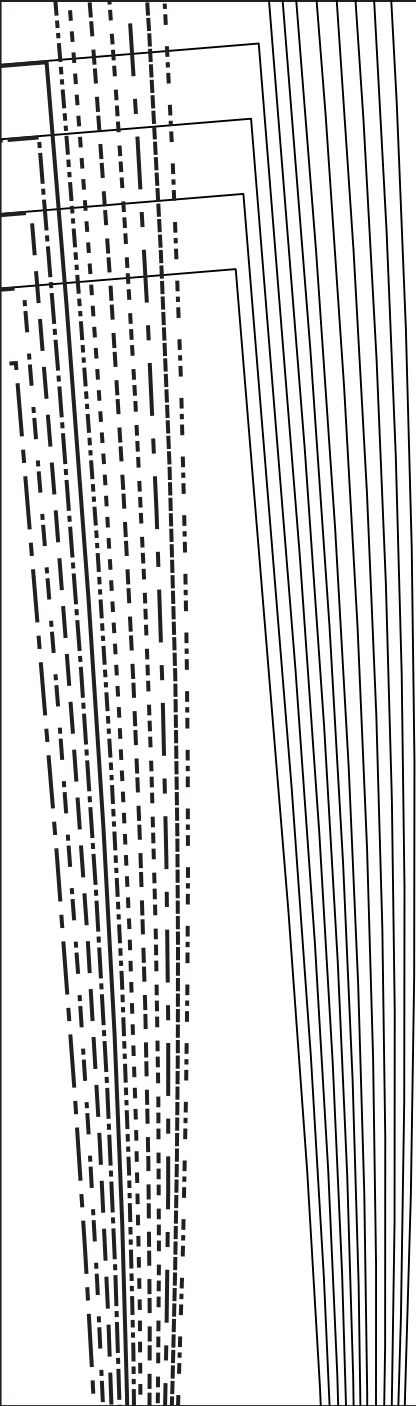

28

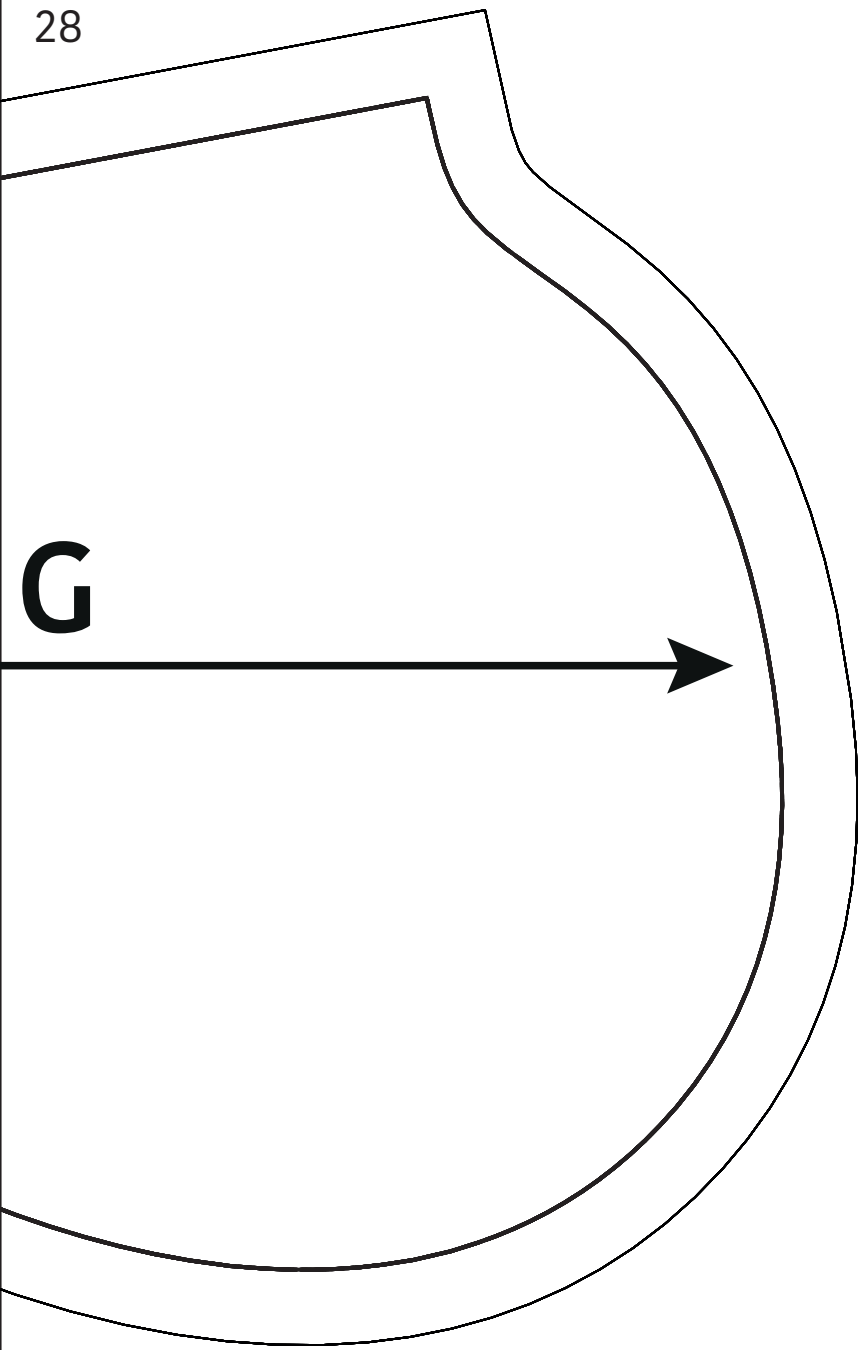

G

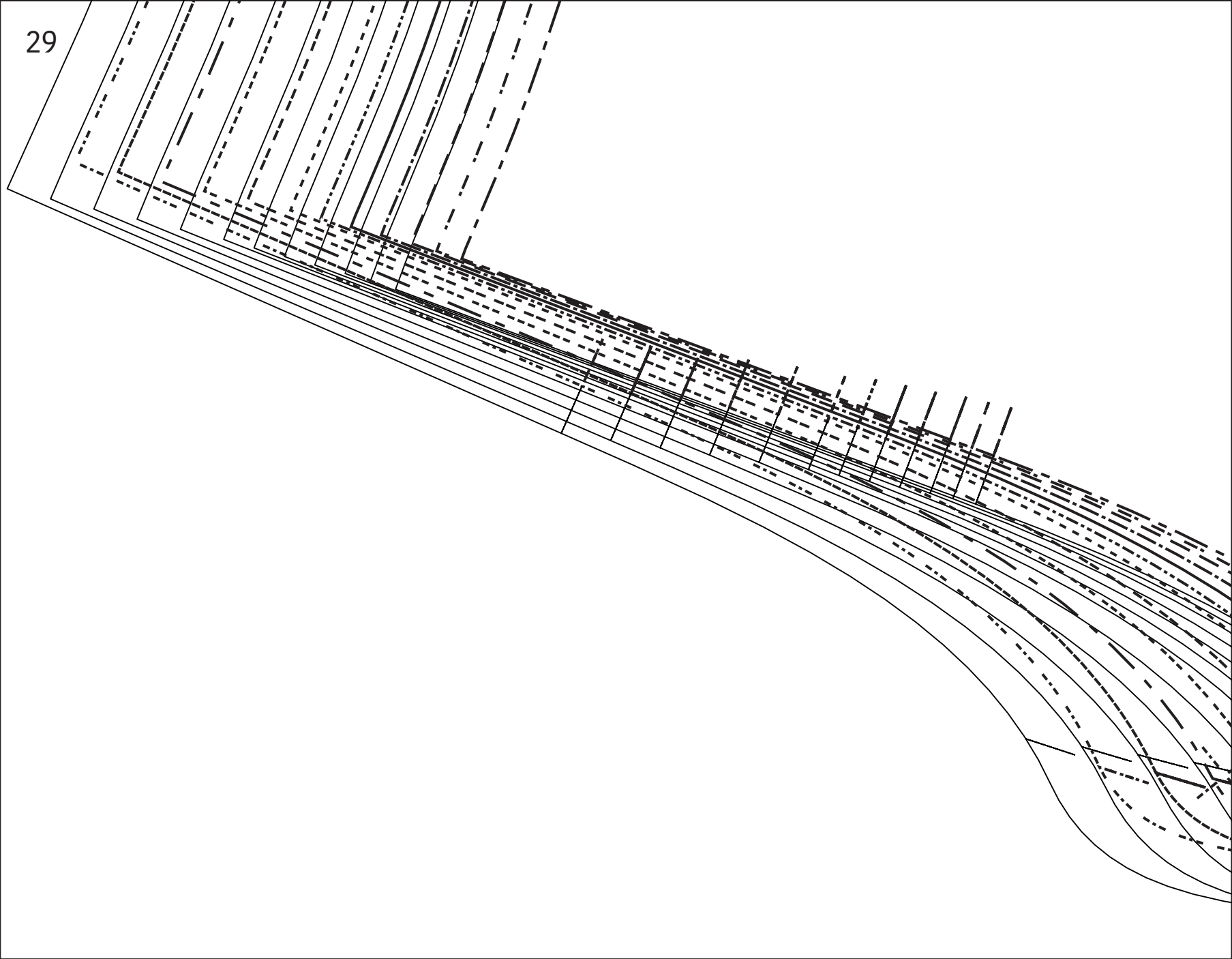

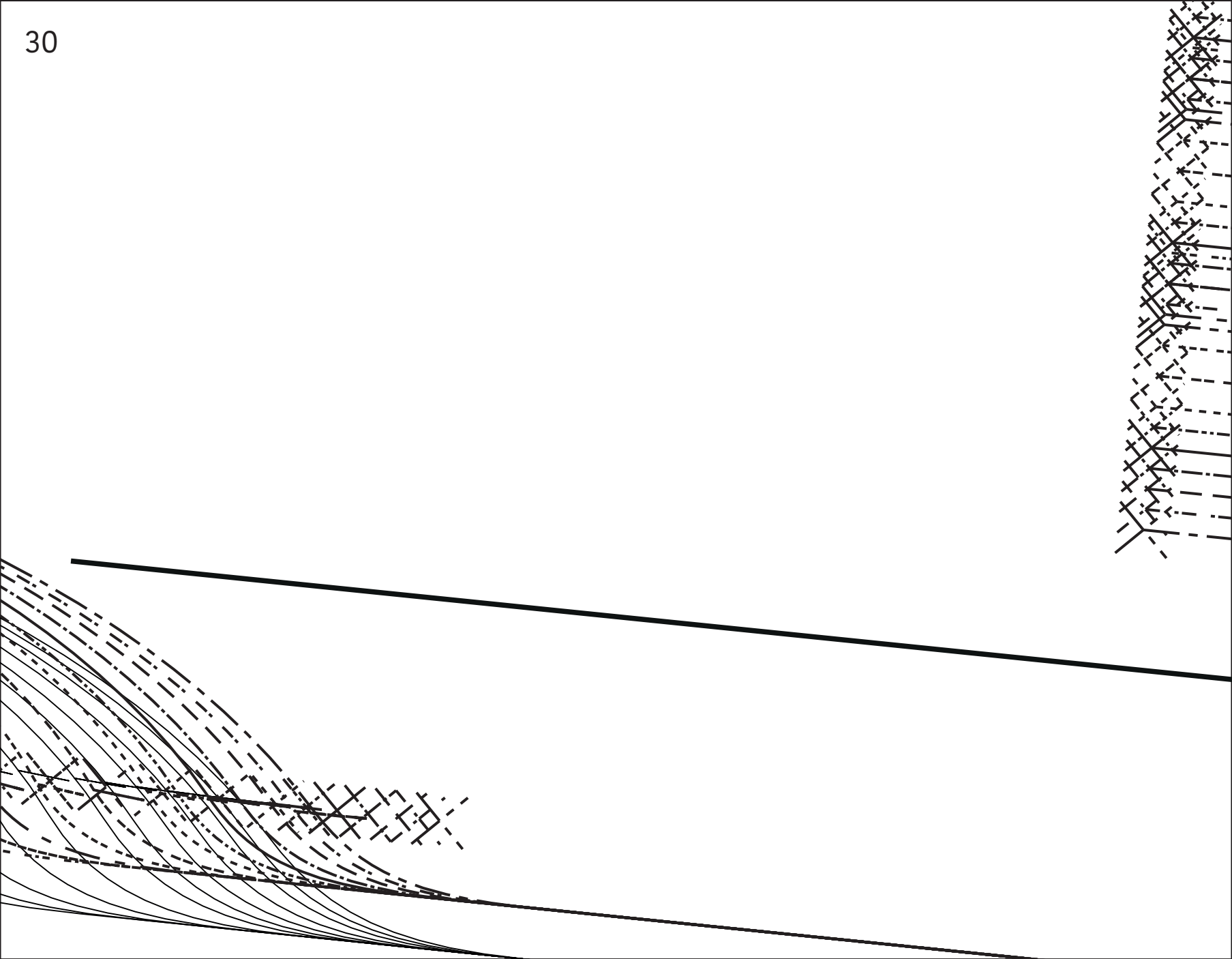

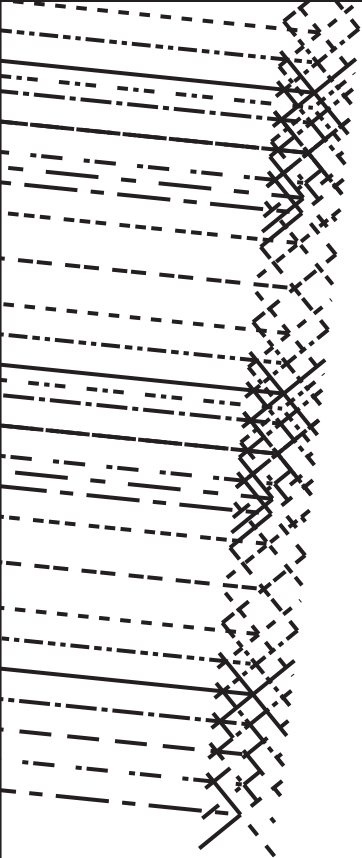

A



MB/MDS/CB/BM

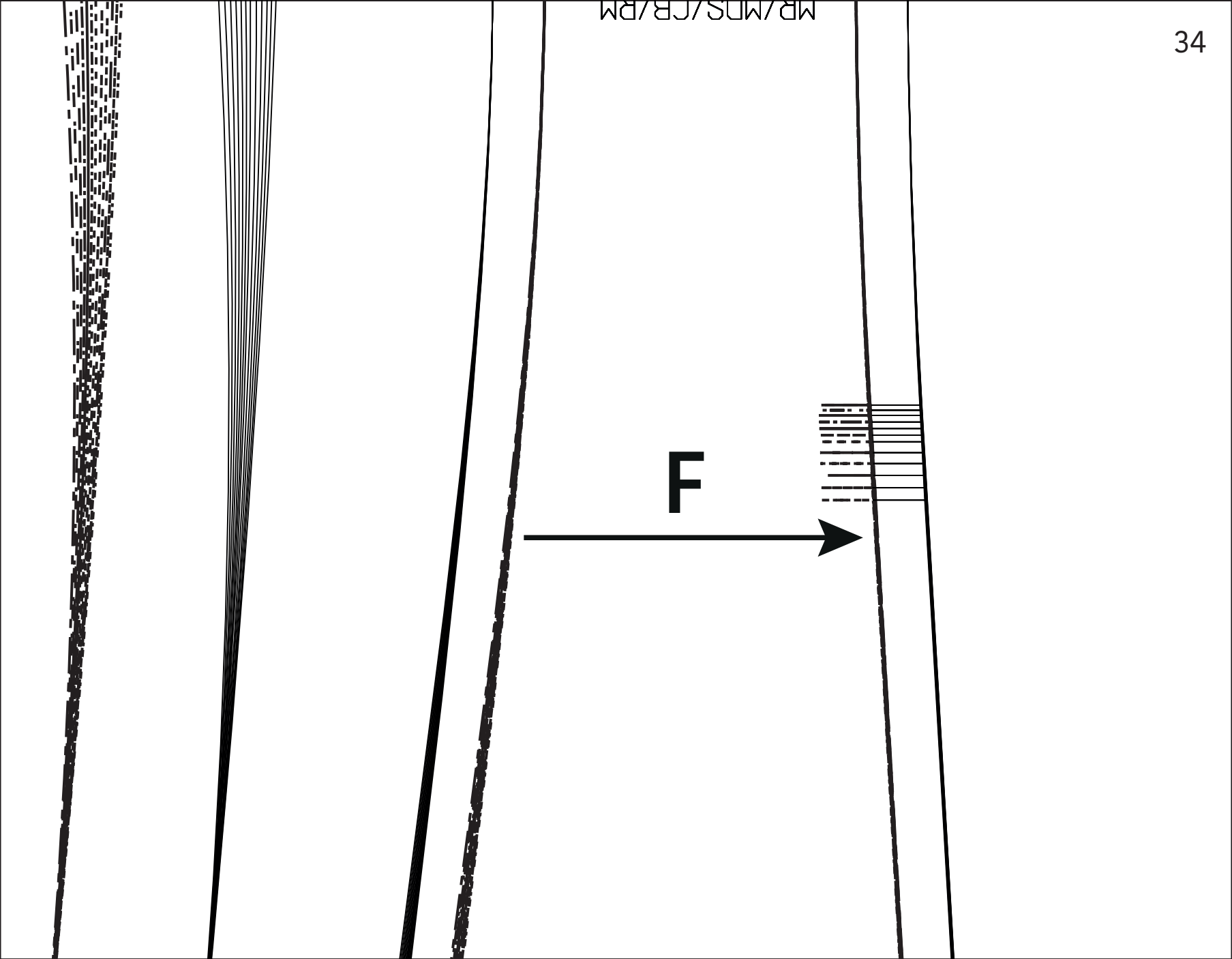

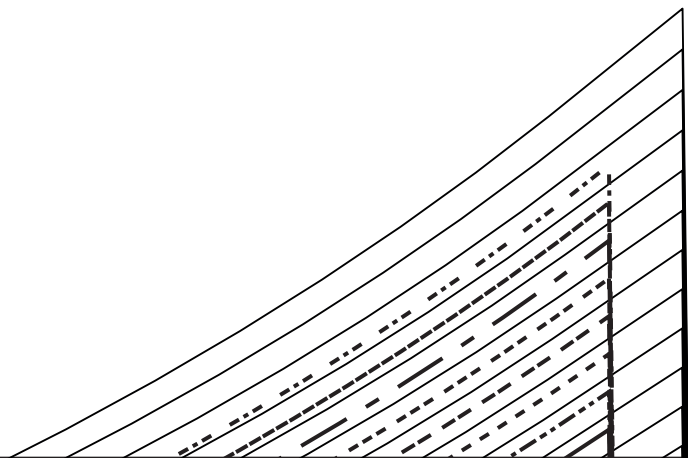

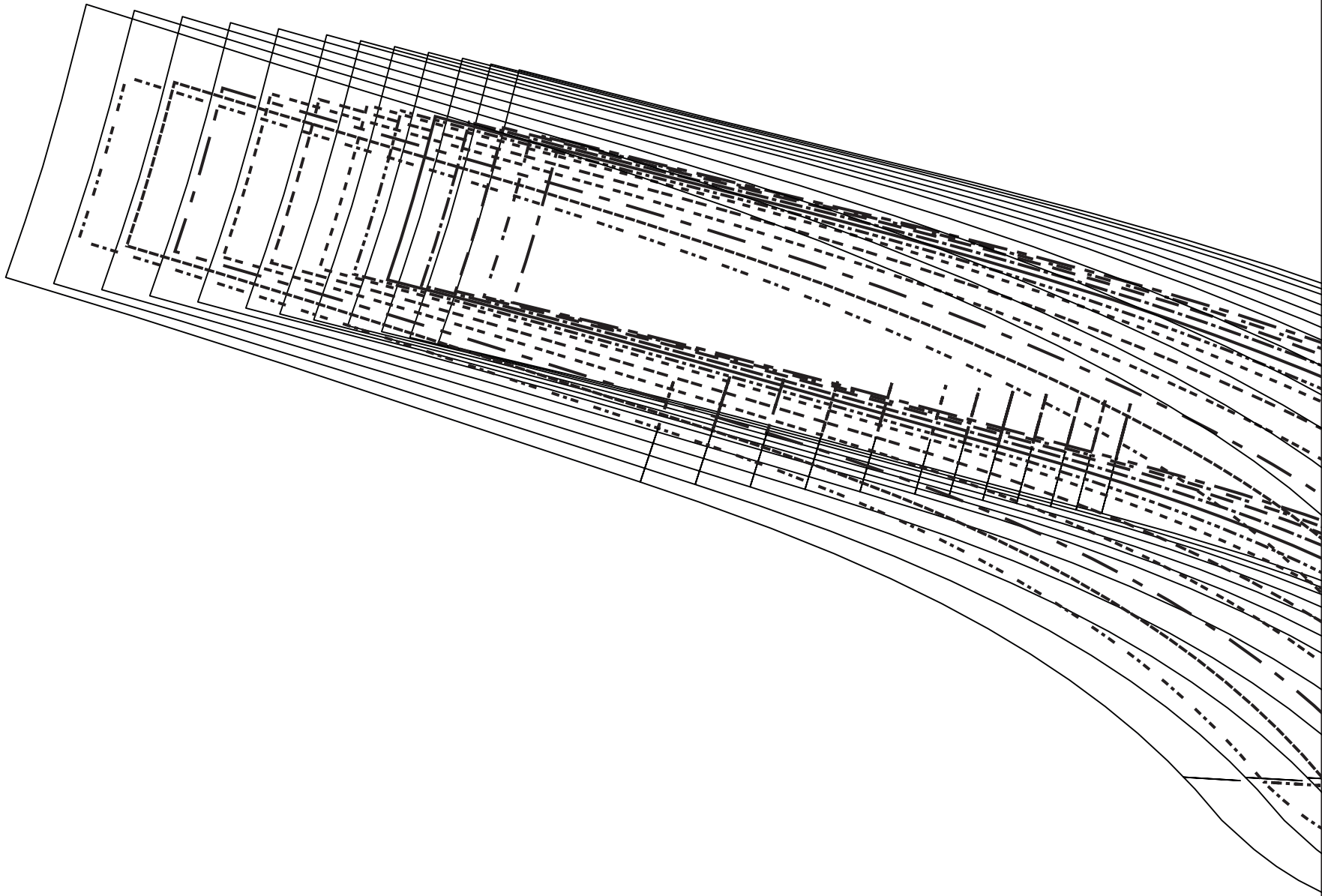

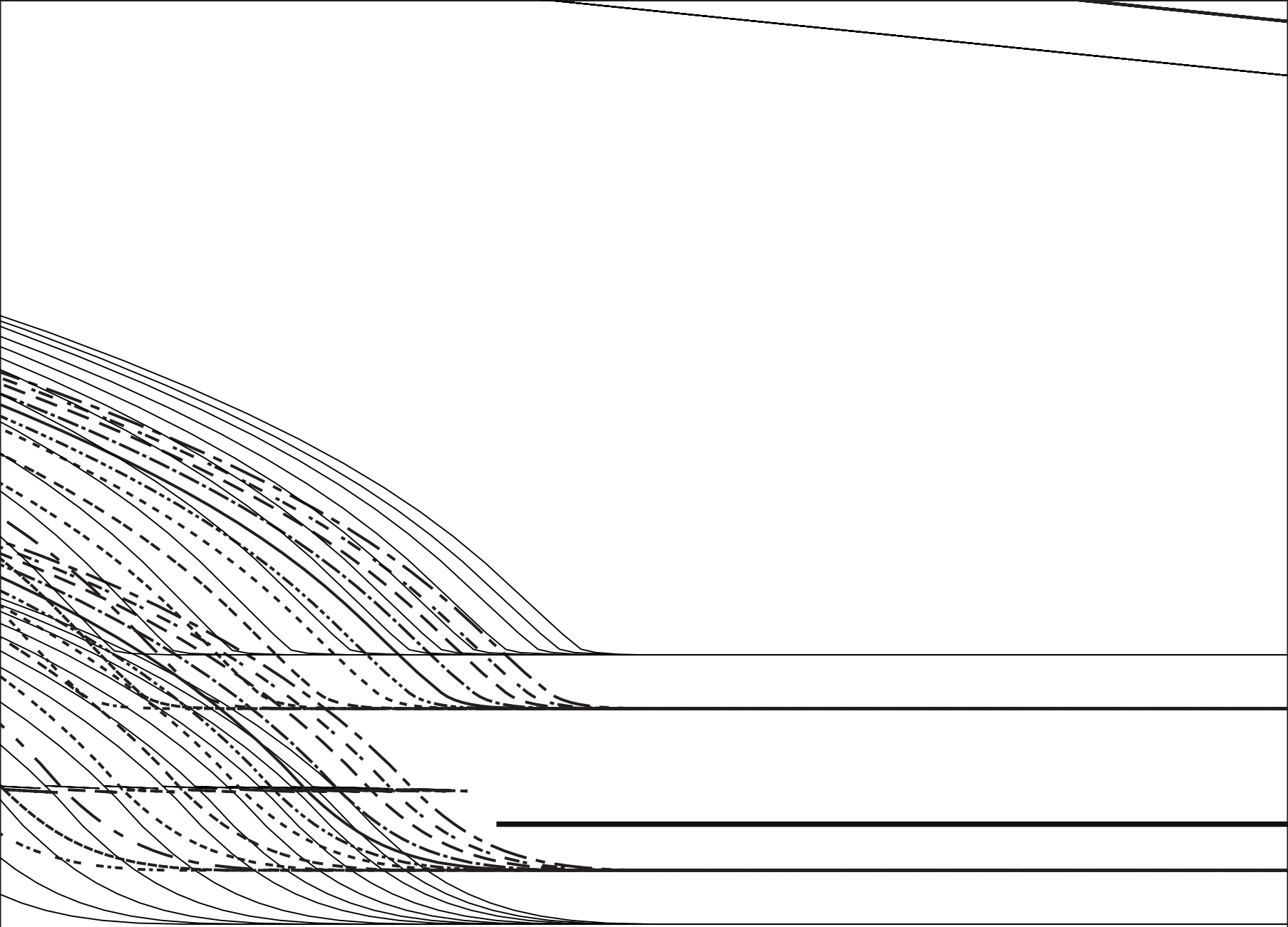

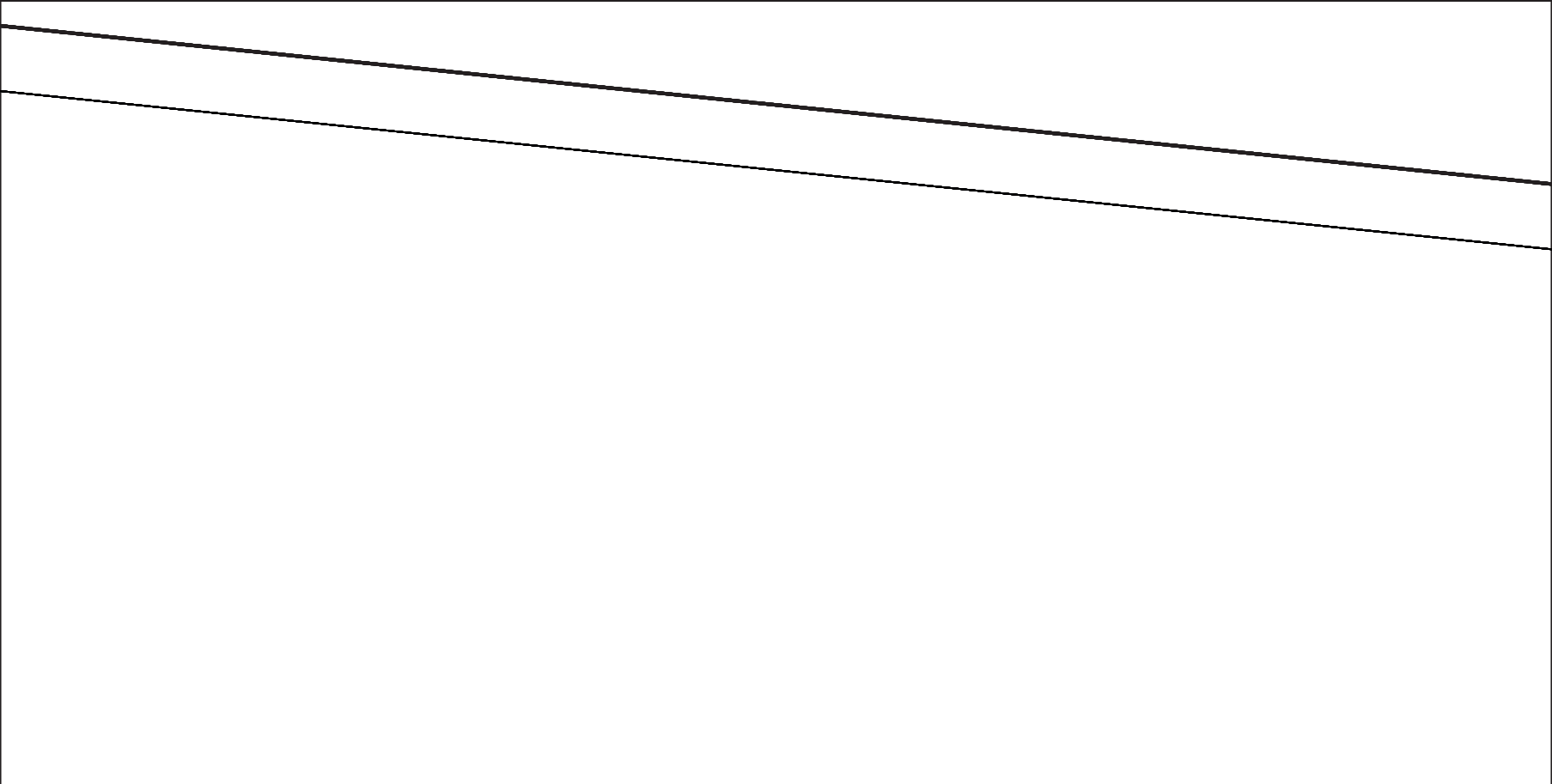

D



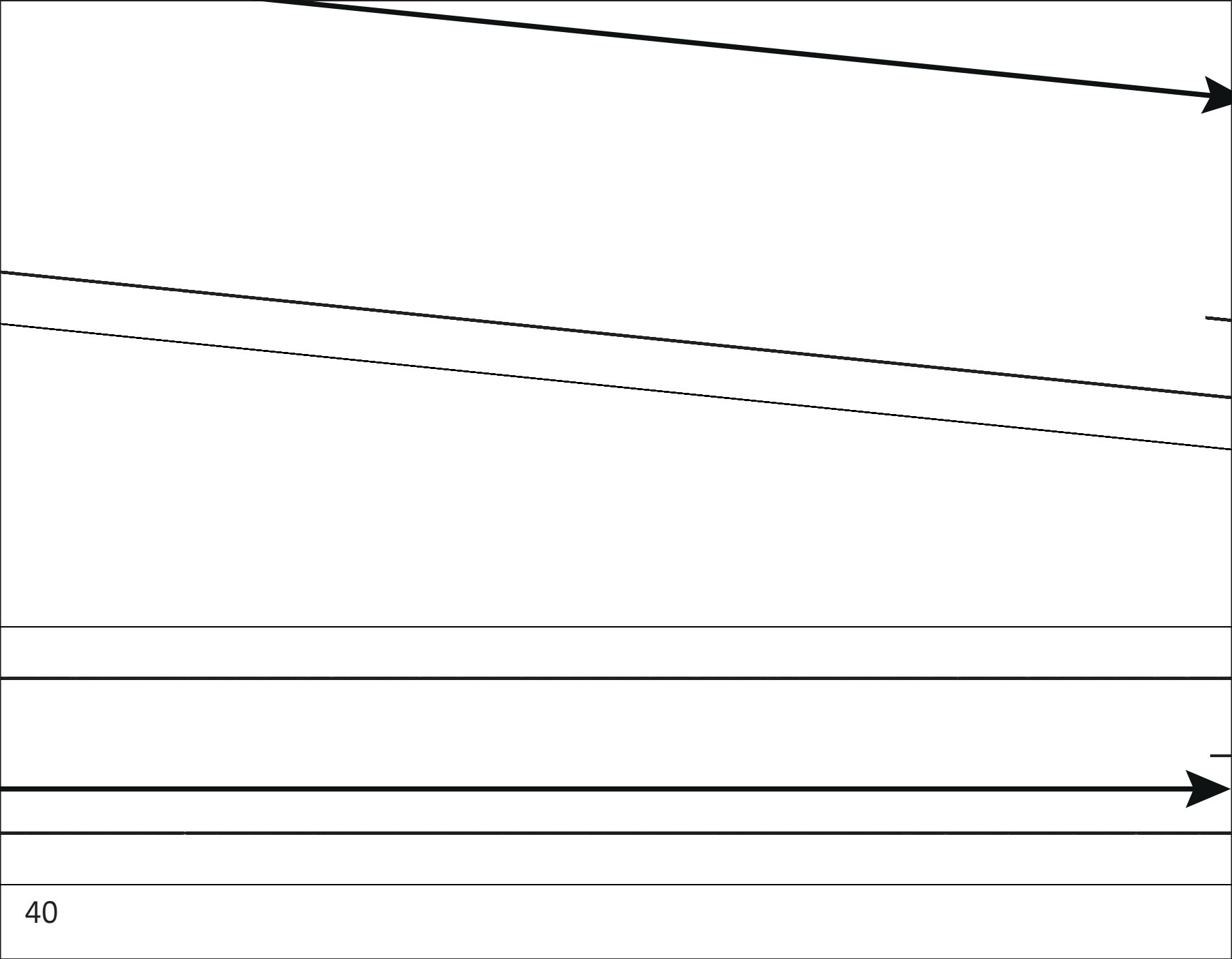

40

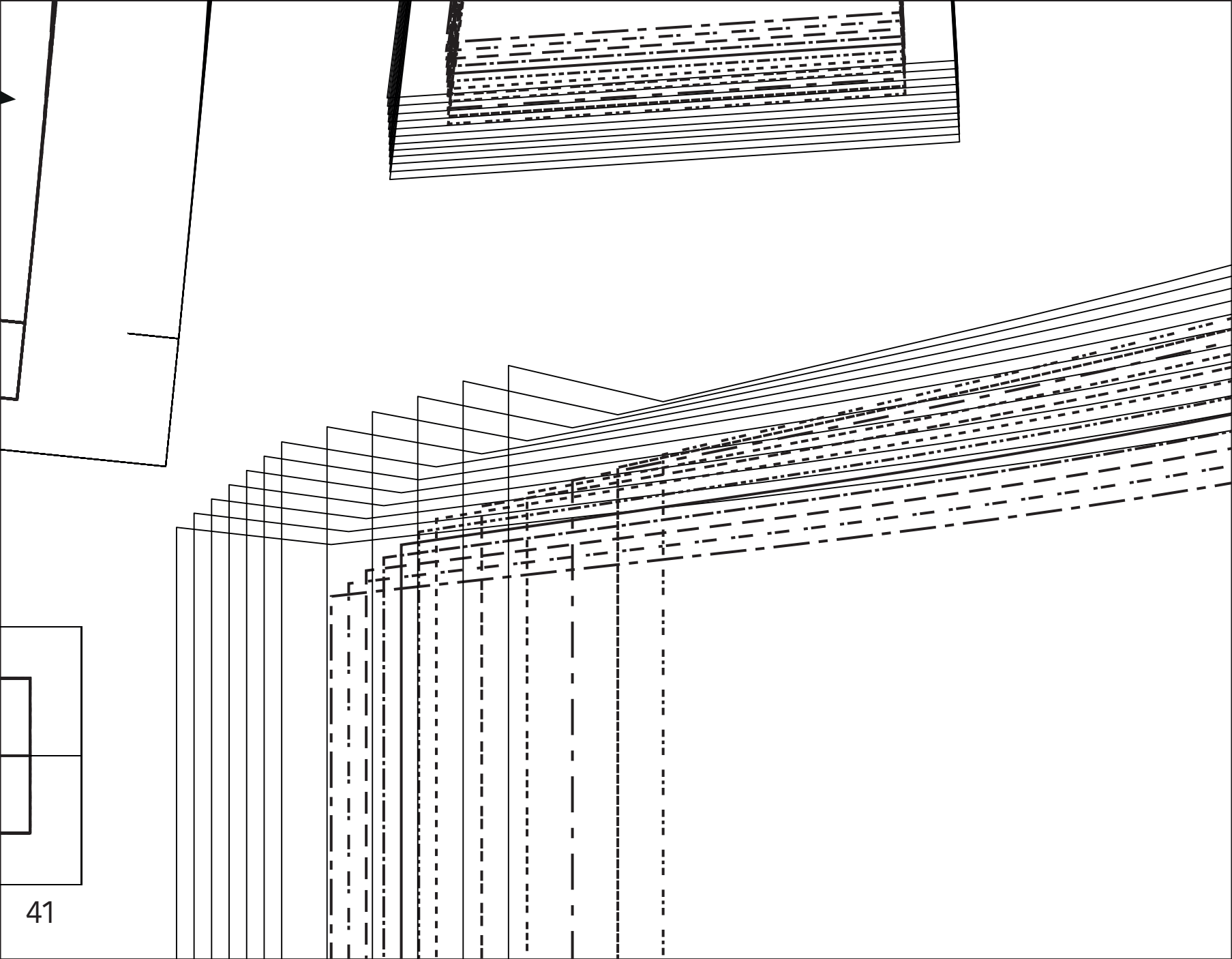

41

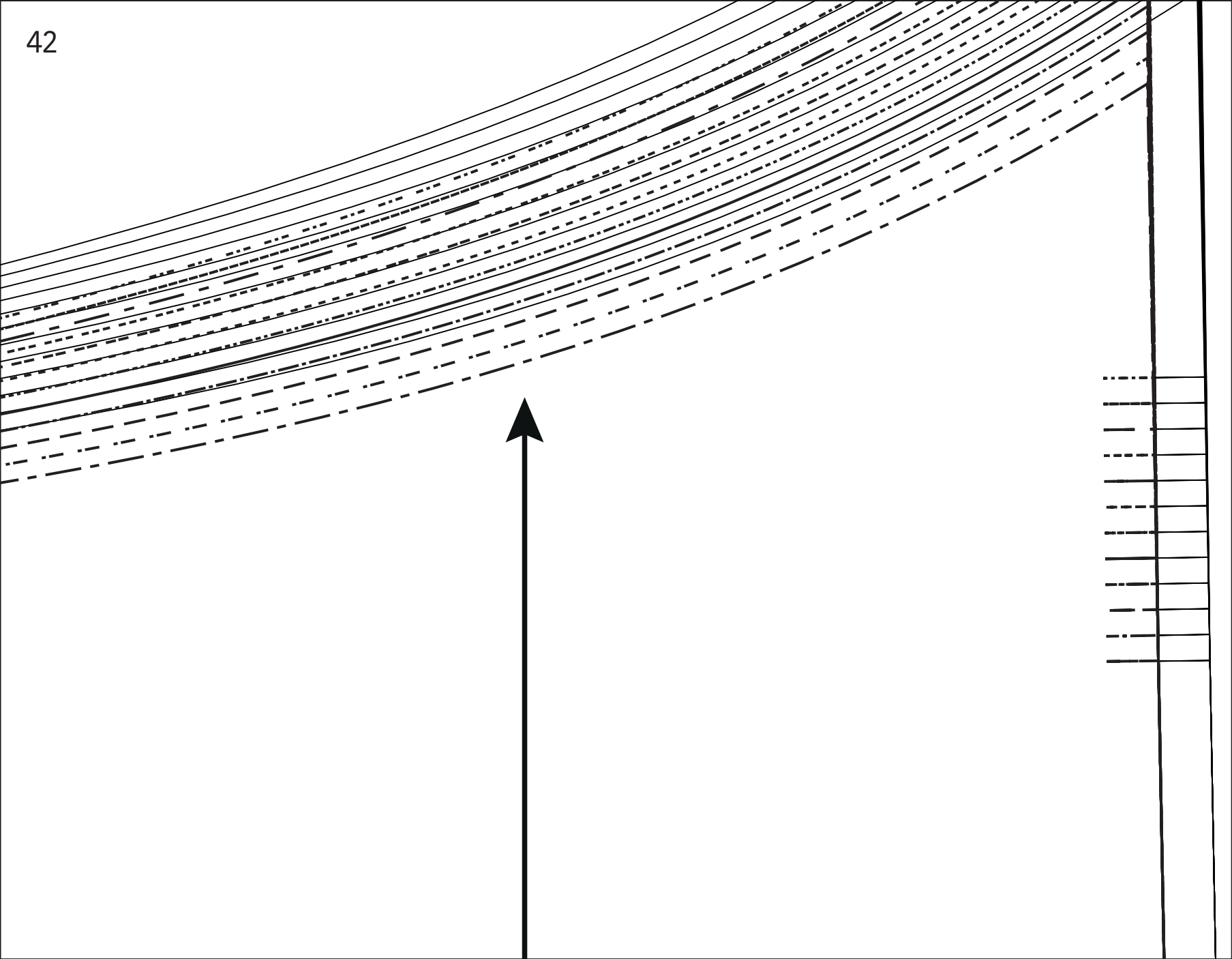

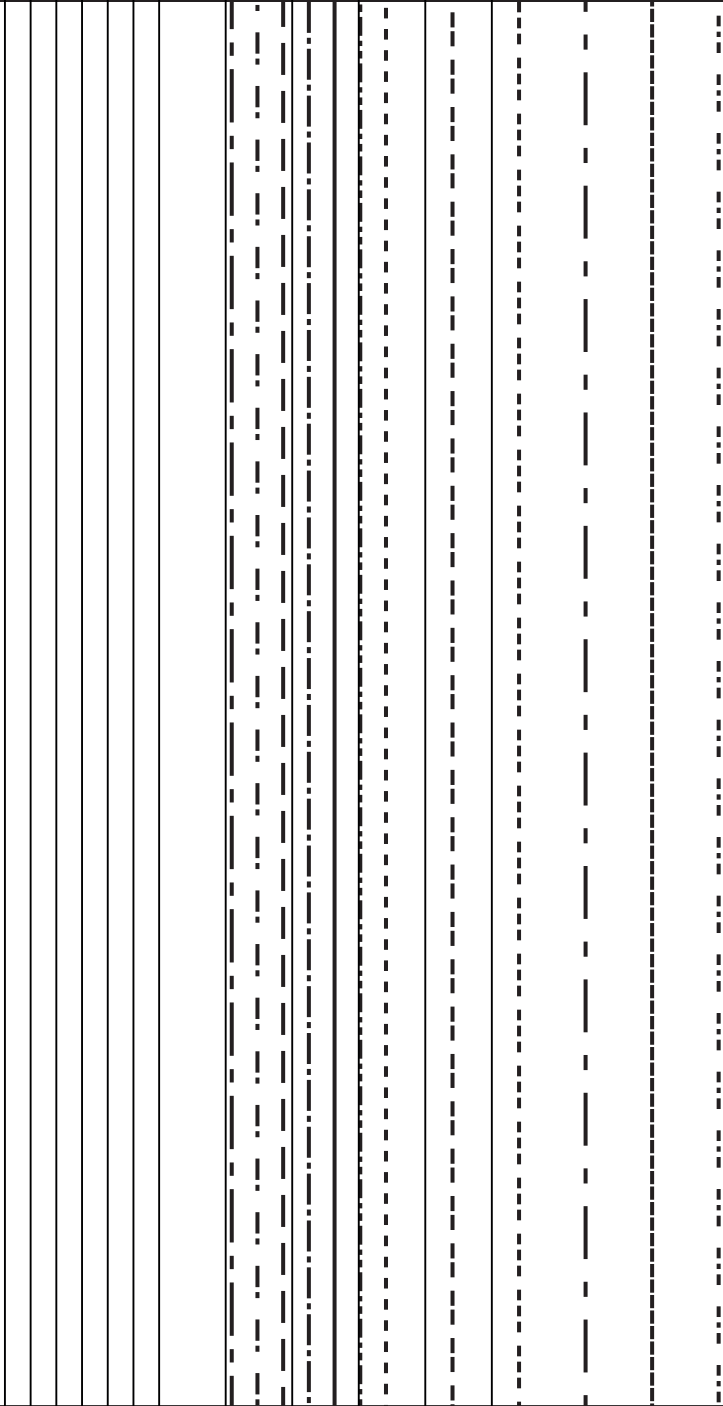

C

