

# Noel

## Broek / Pantalon / Trousers / Hose

### Maten / Tailles / Sizes / Größen:

.....	92
-----	98
-----	104
- - - - -	110
-----	116
-----	122 / 128
—————	134 / 140
-----	146 / 152
-----	158 / 164
-----	170 / 176

### Patroondelen / Pièces du patron / Pattern pieces / Schnittteile:

- A** voorpand / devant / front panel /  
Vorderteil
- B** rugpand / dos / back panel /  
Rückenteil
- C** tailleband / ceinture / waistband /  
Bund
- D** zijzak / poche / side pocket /  
seitliche Tasche

Patroonschema / Schéma du Patron / Pattern Diagram /  
Übersichtsplan zum Zusammenkleben

1	2	3	4	5	6
7	8	9	10	11	12
13	14	15	16	17	18
19	20	21	22		

Controlevierkant / Carré de controle  
/ Test square / Kontrollquadrat

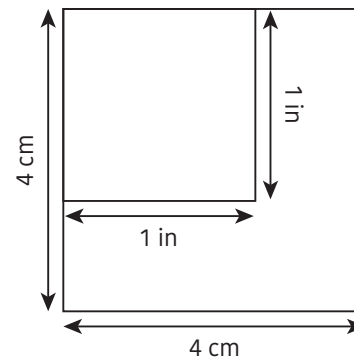

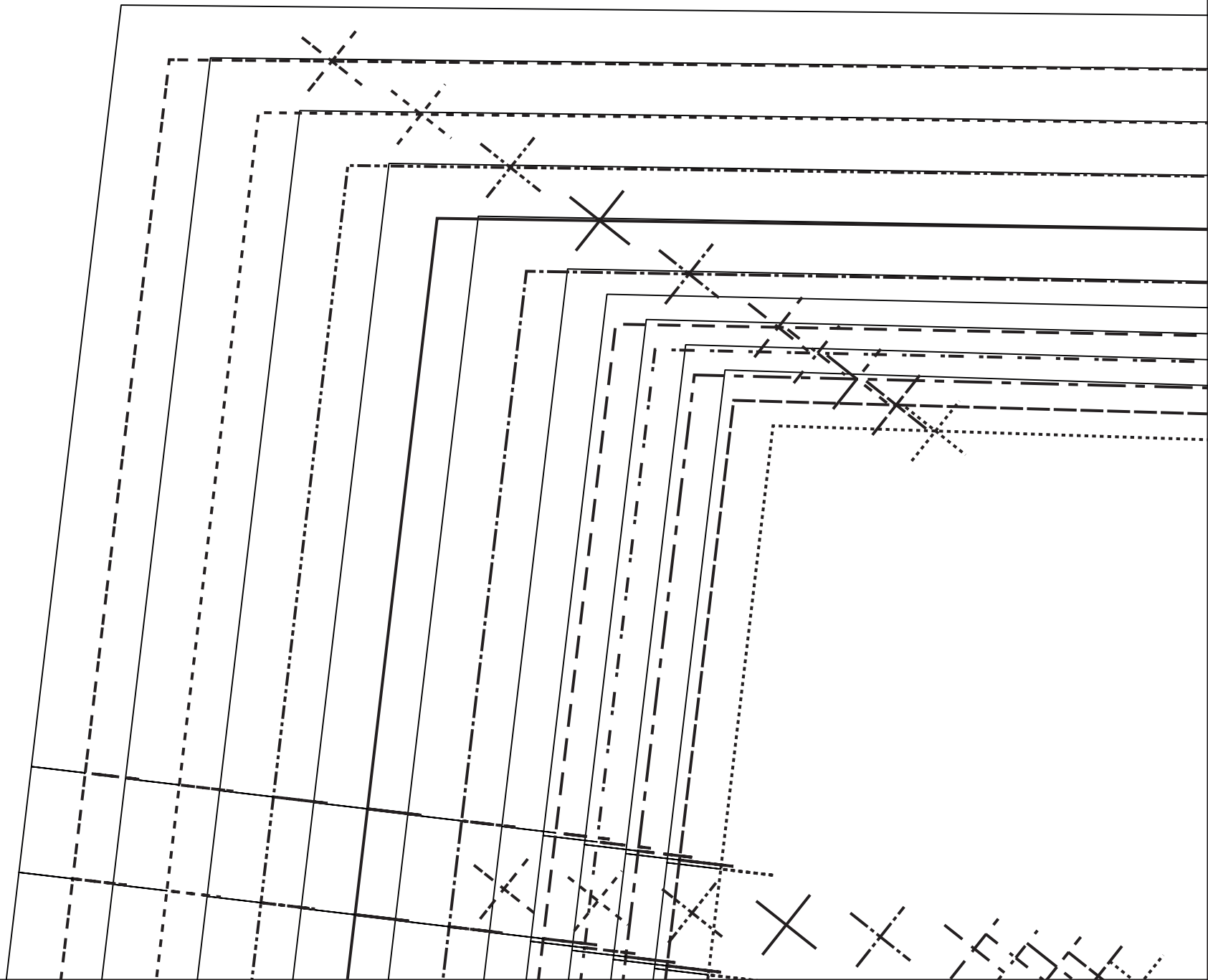

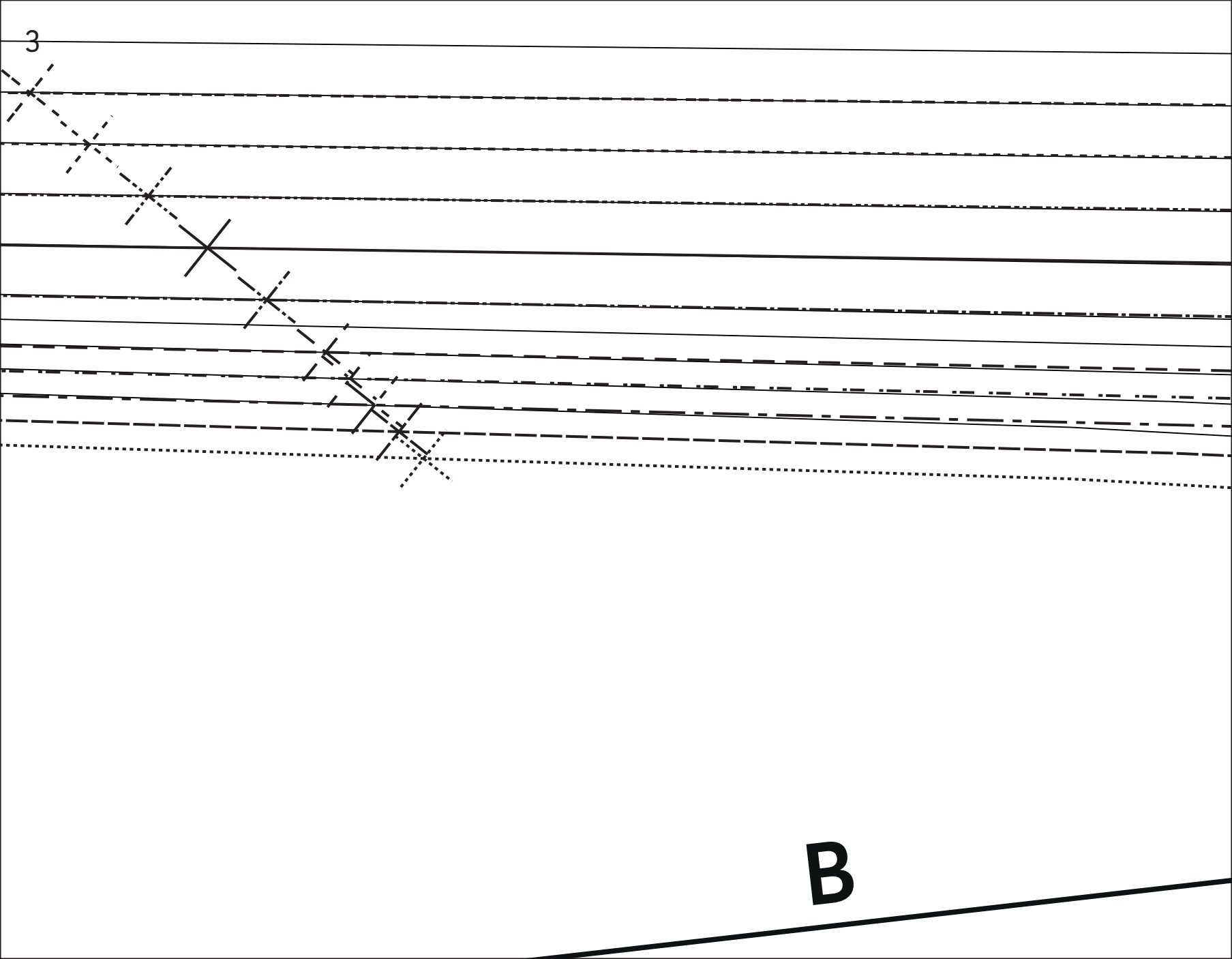

3

**B**

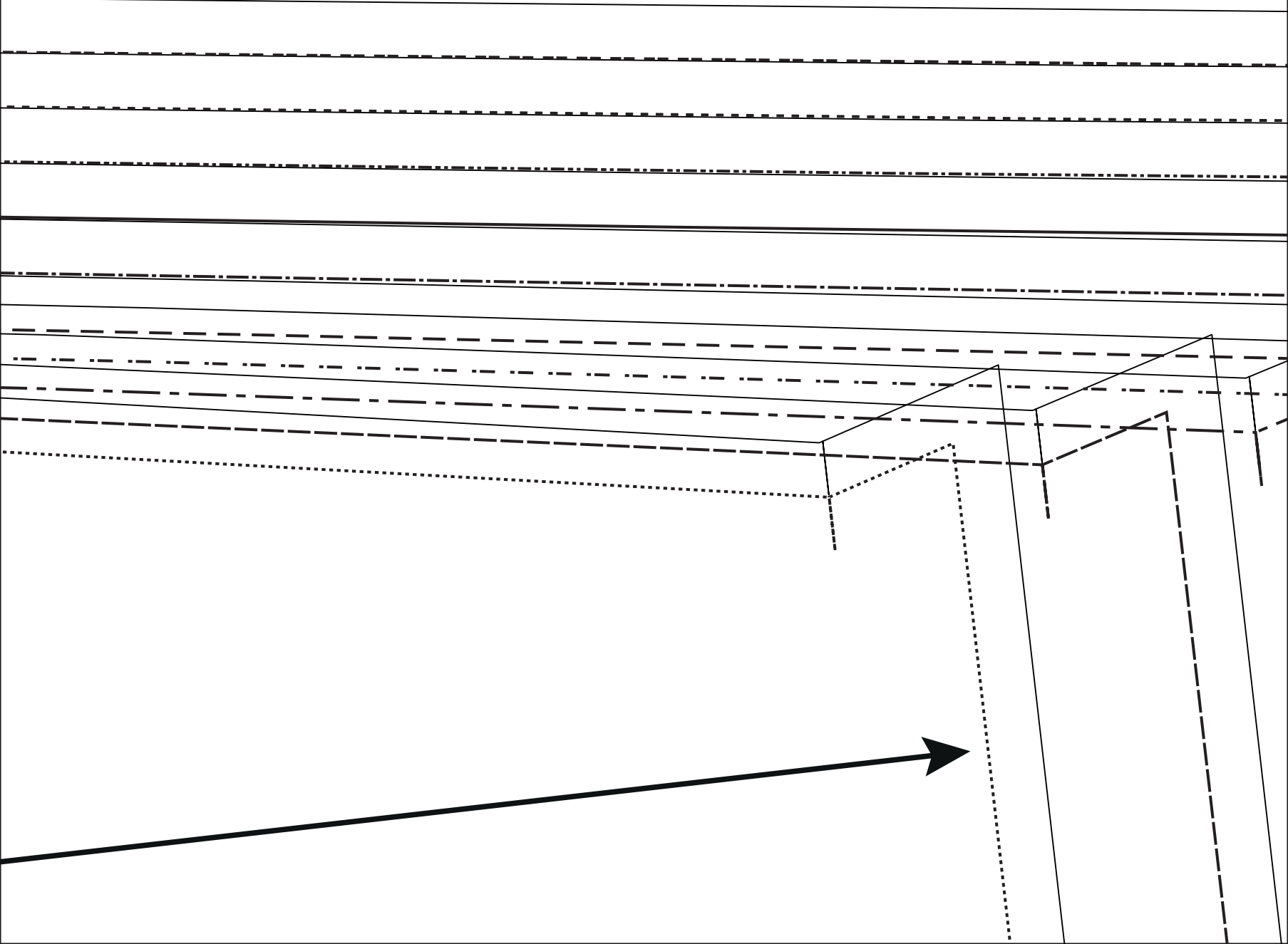

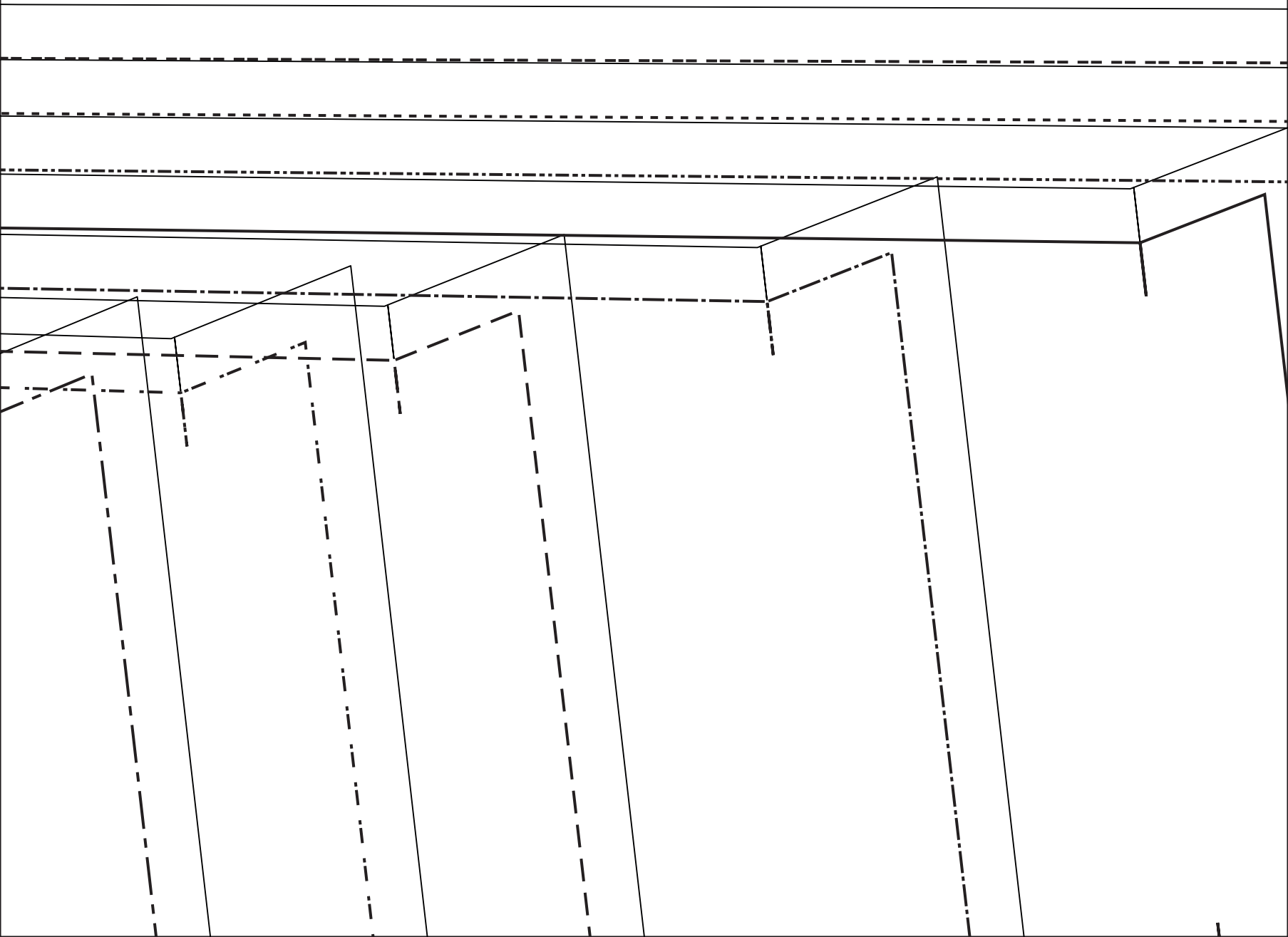

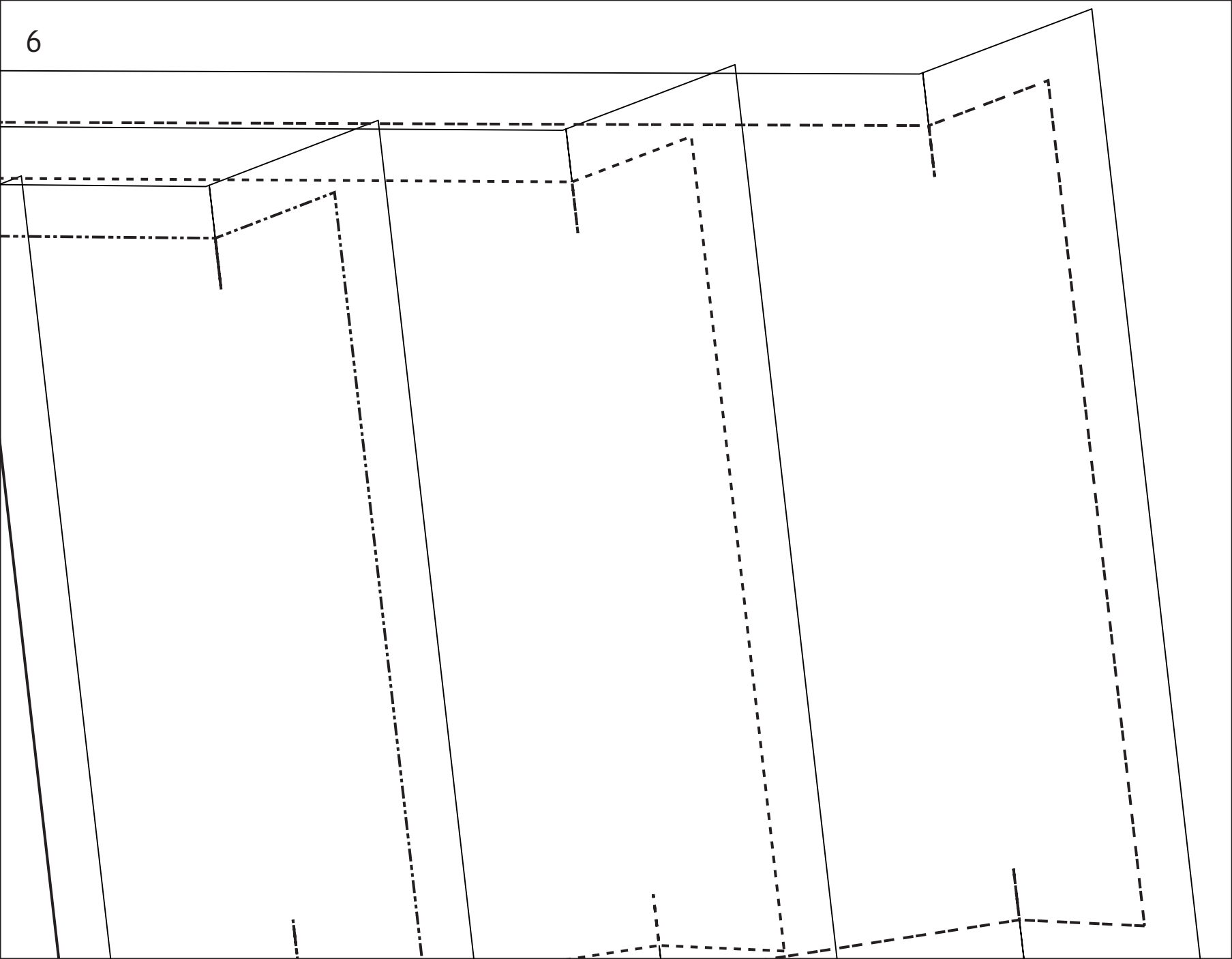

7

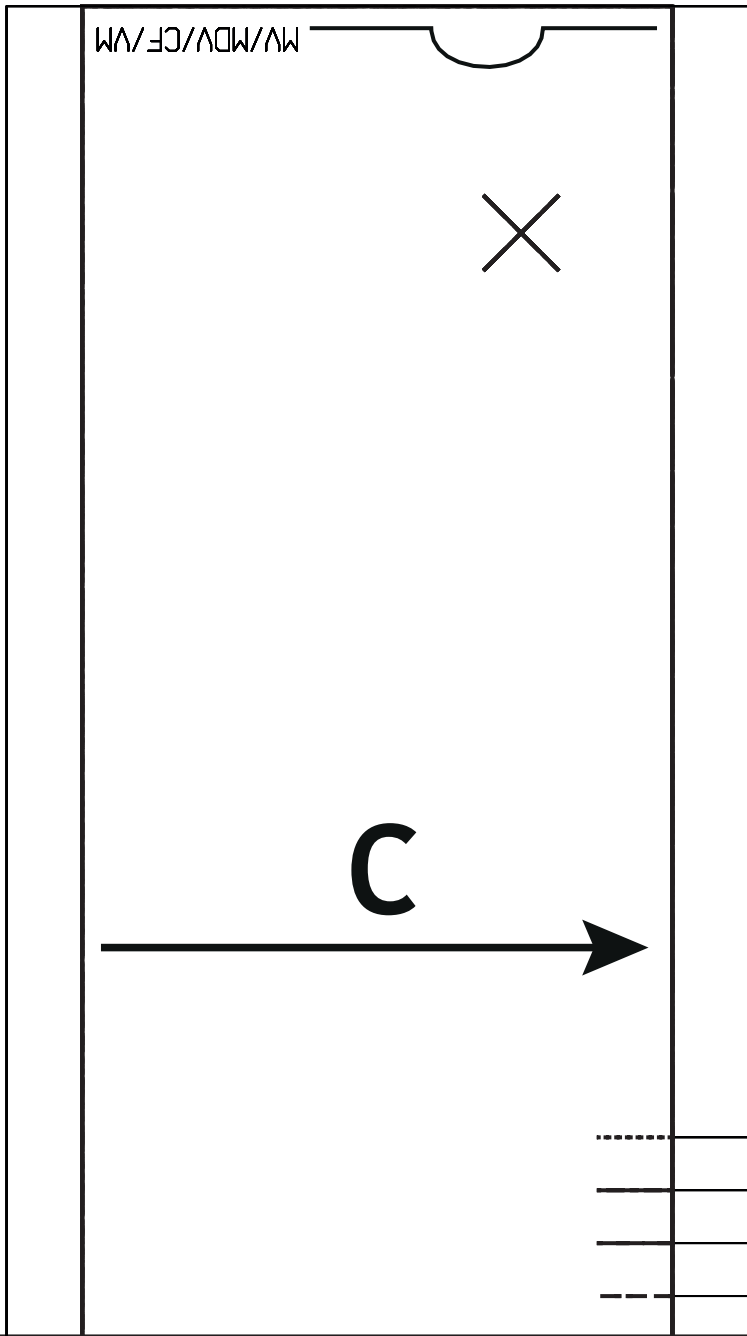

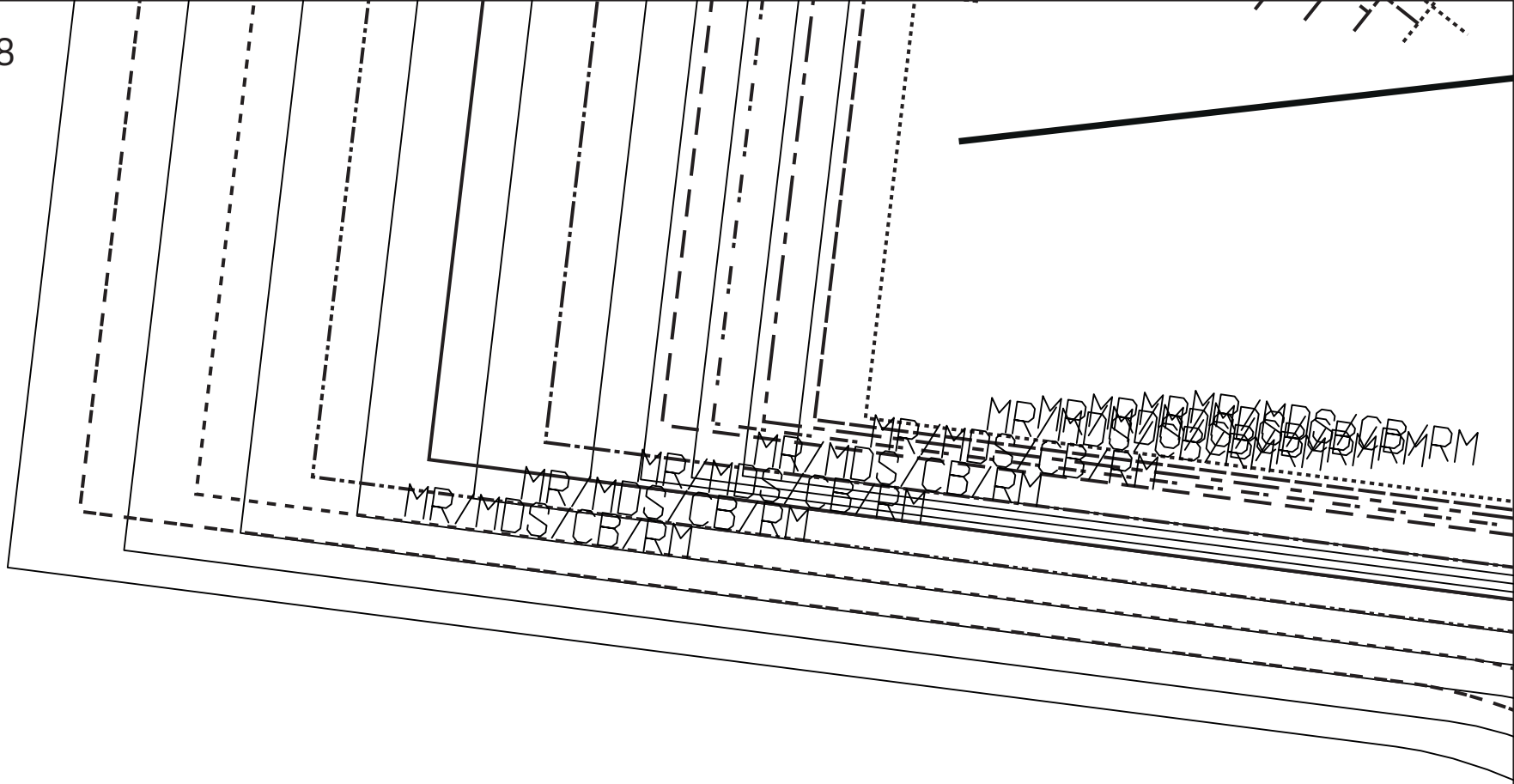



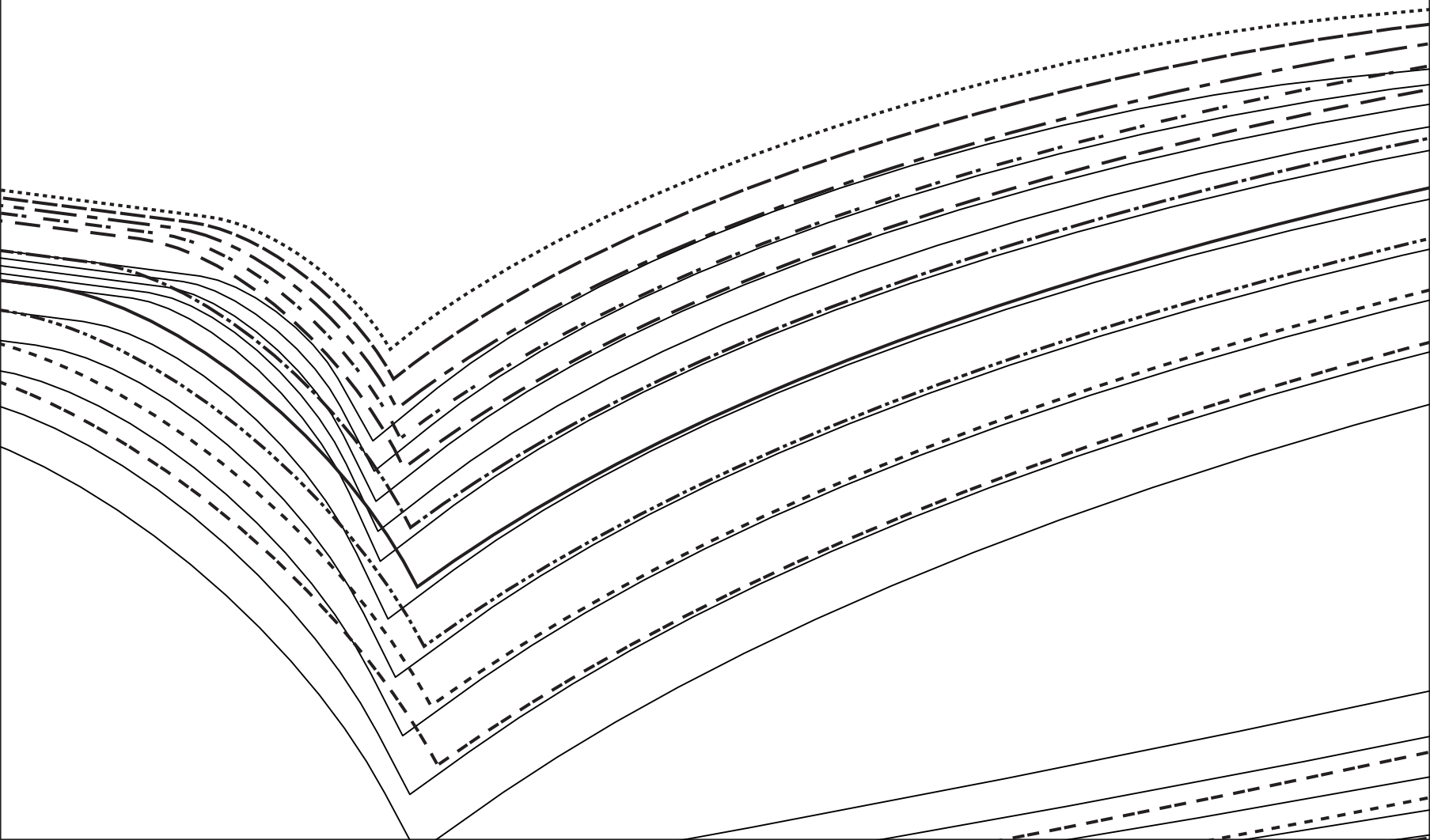

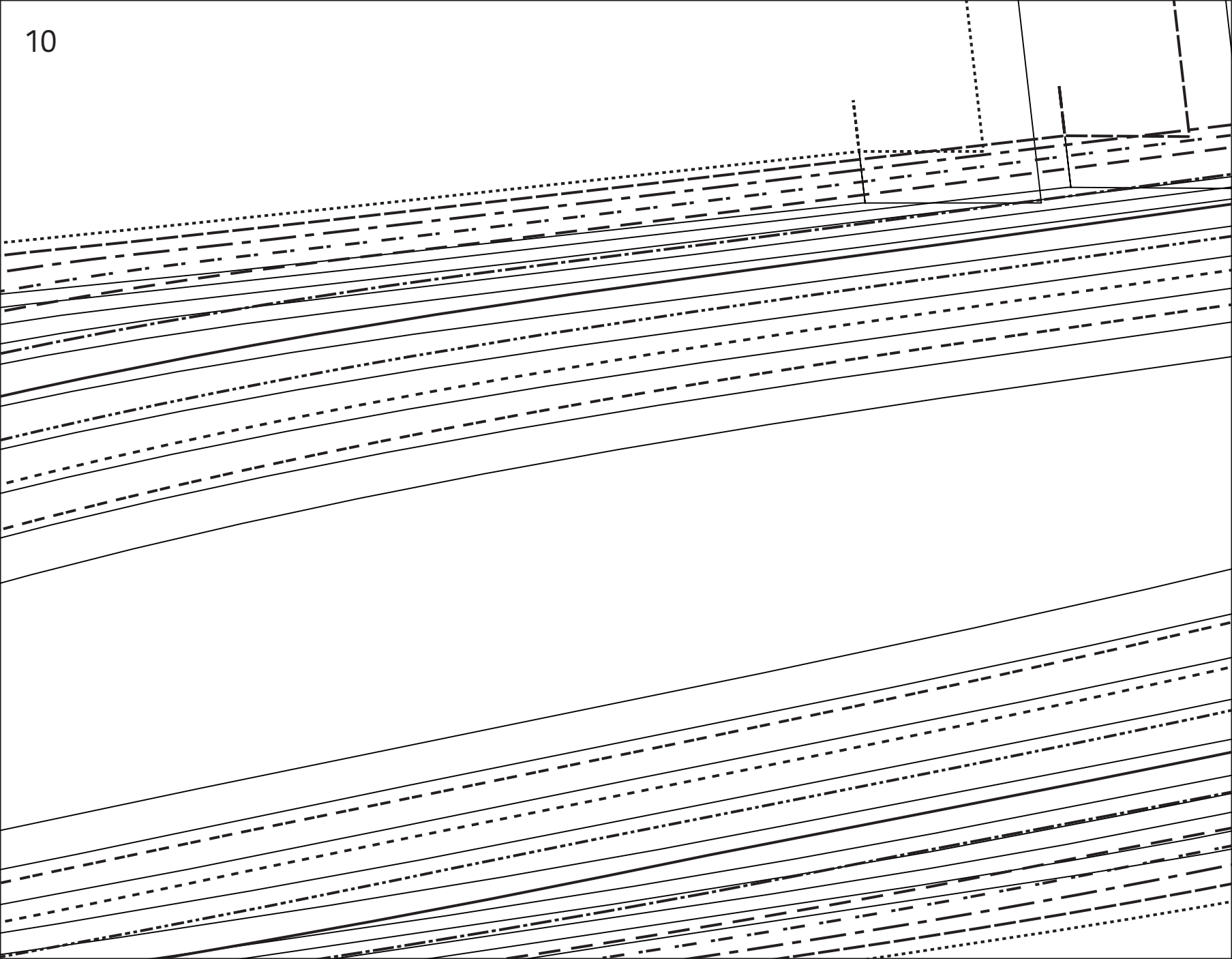

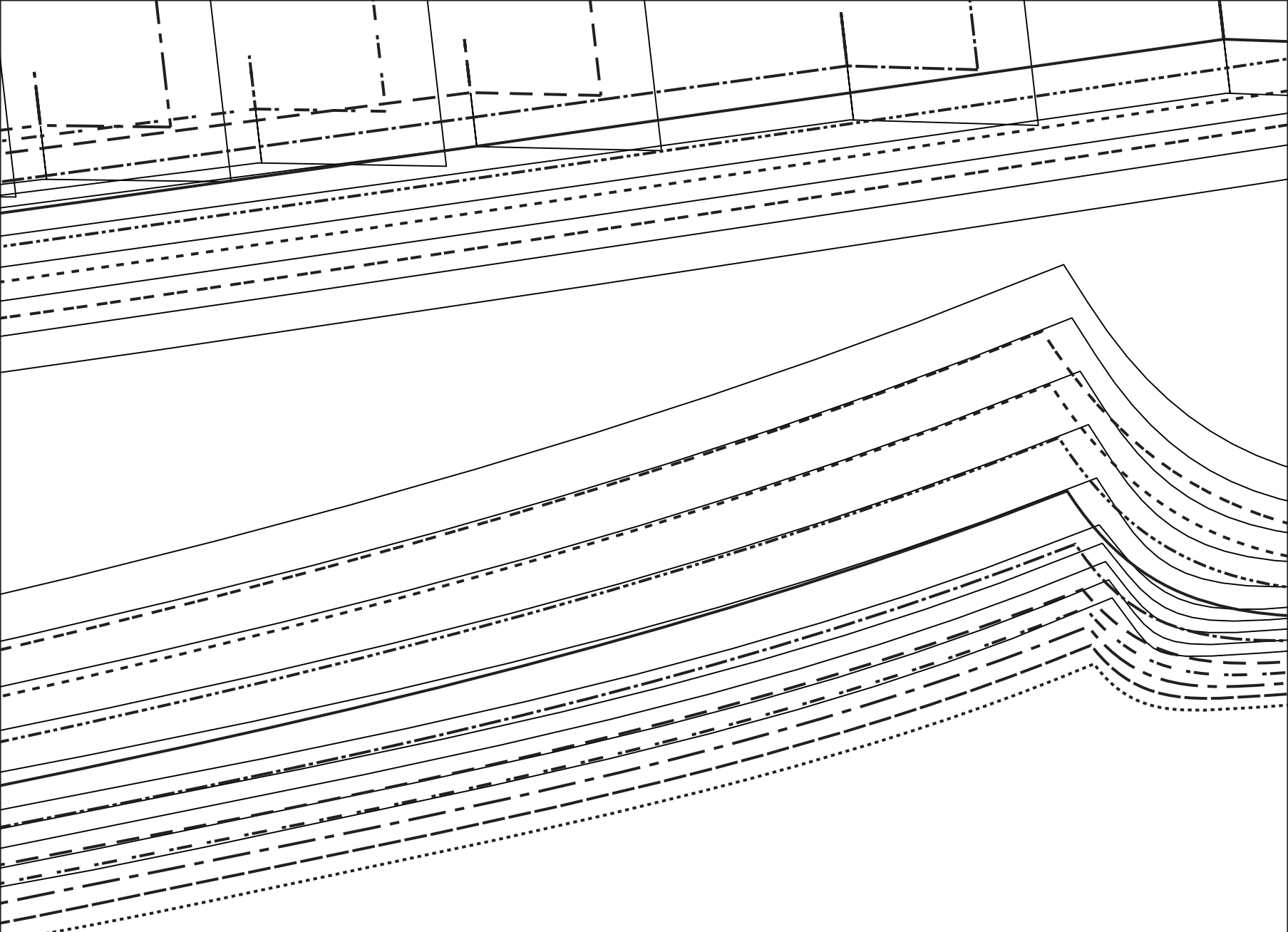

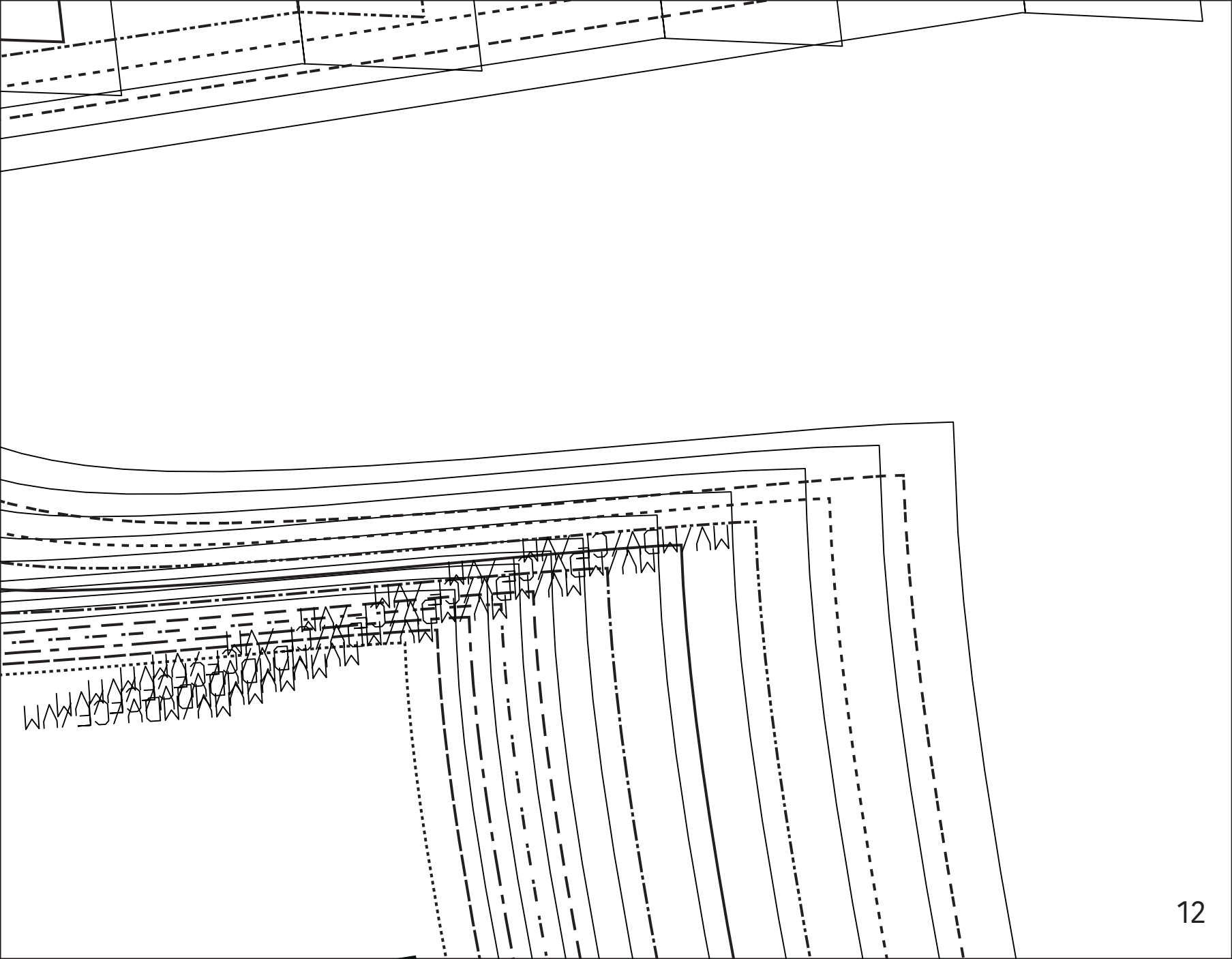

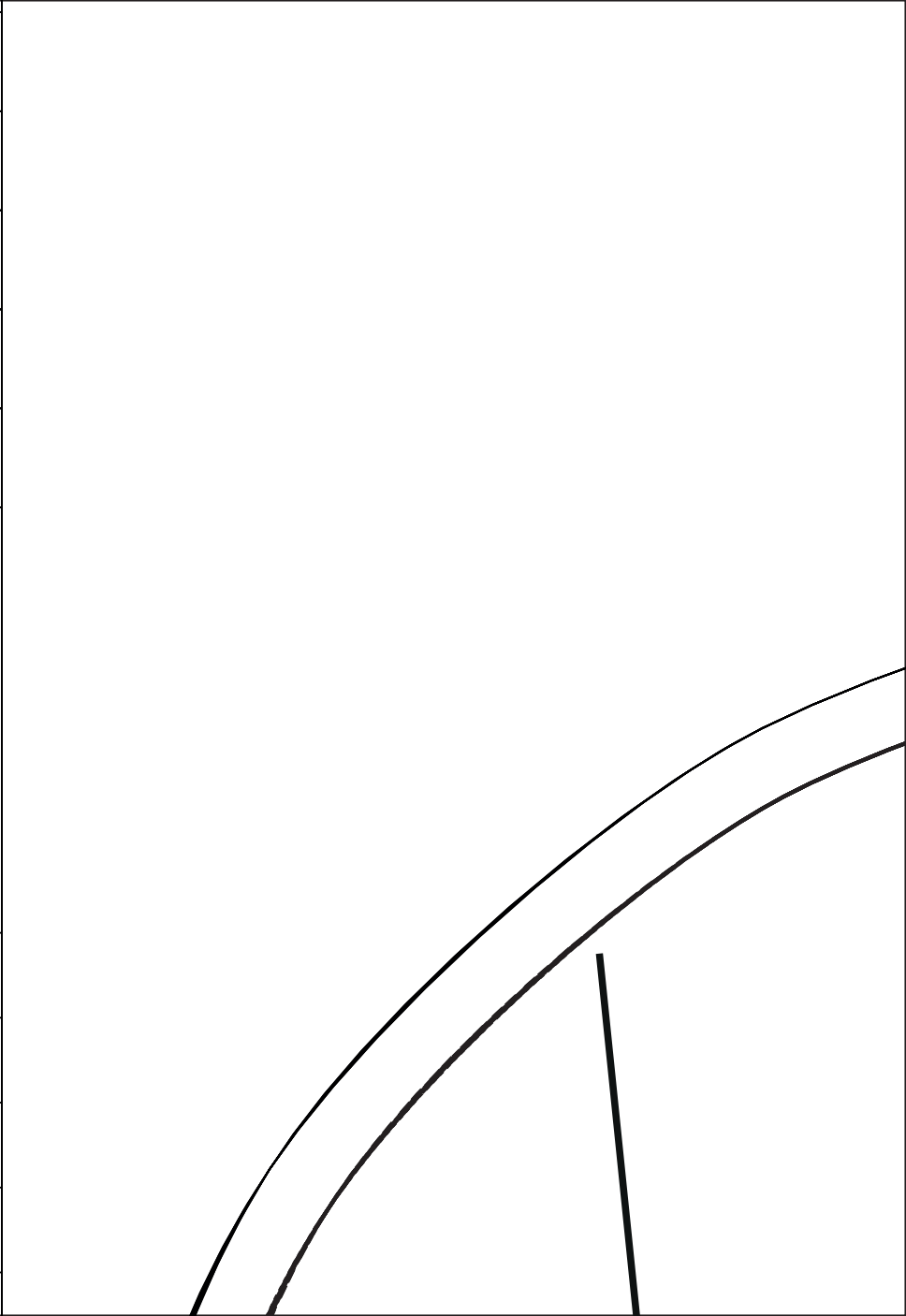
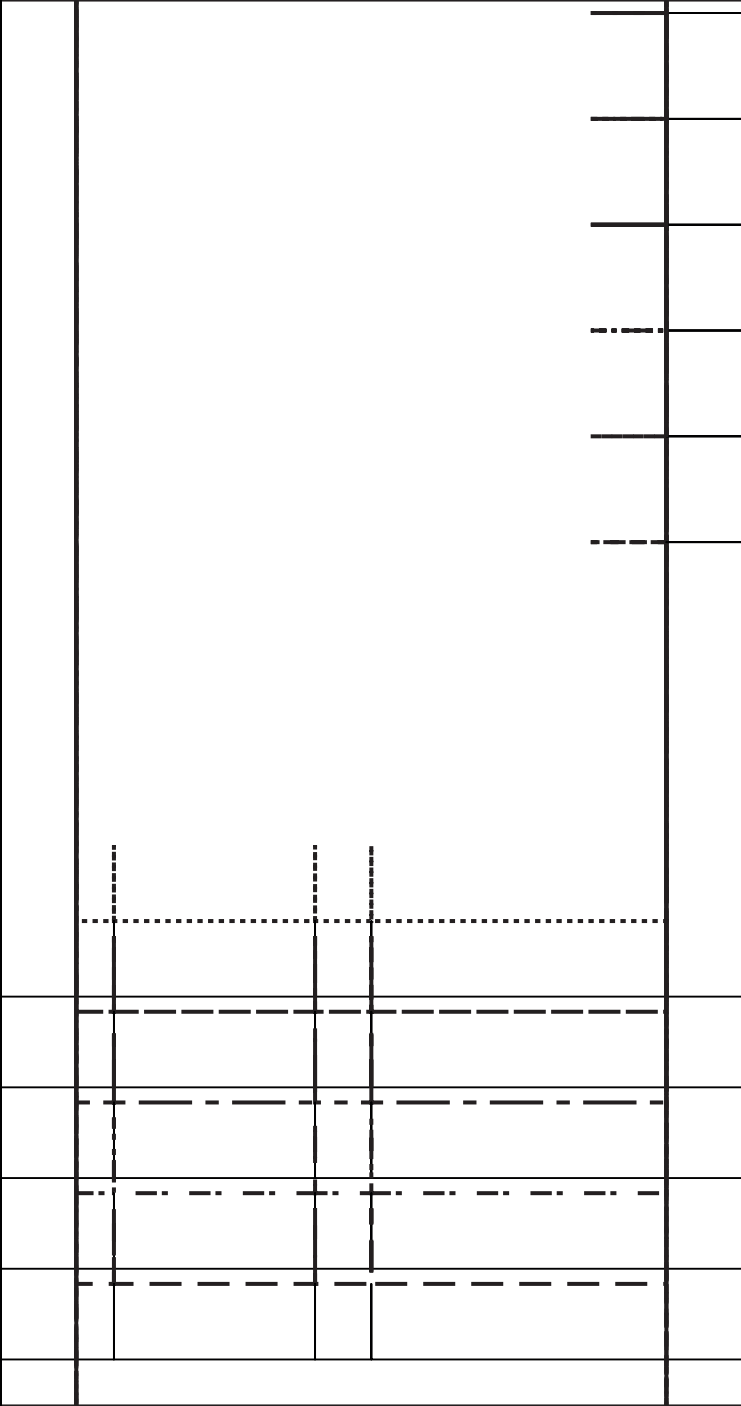

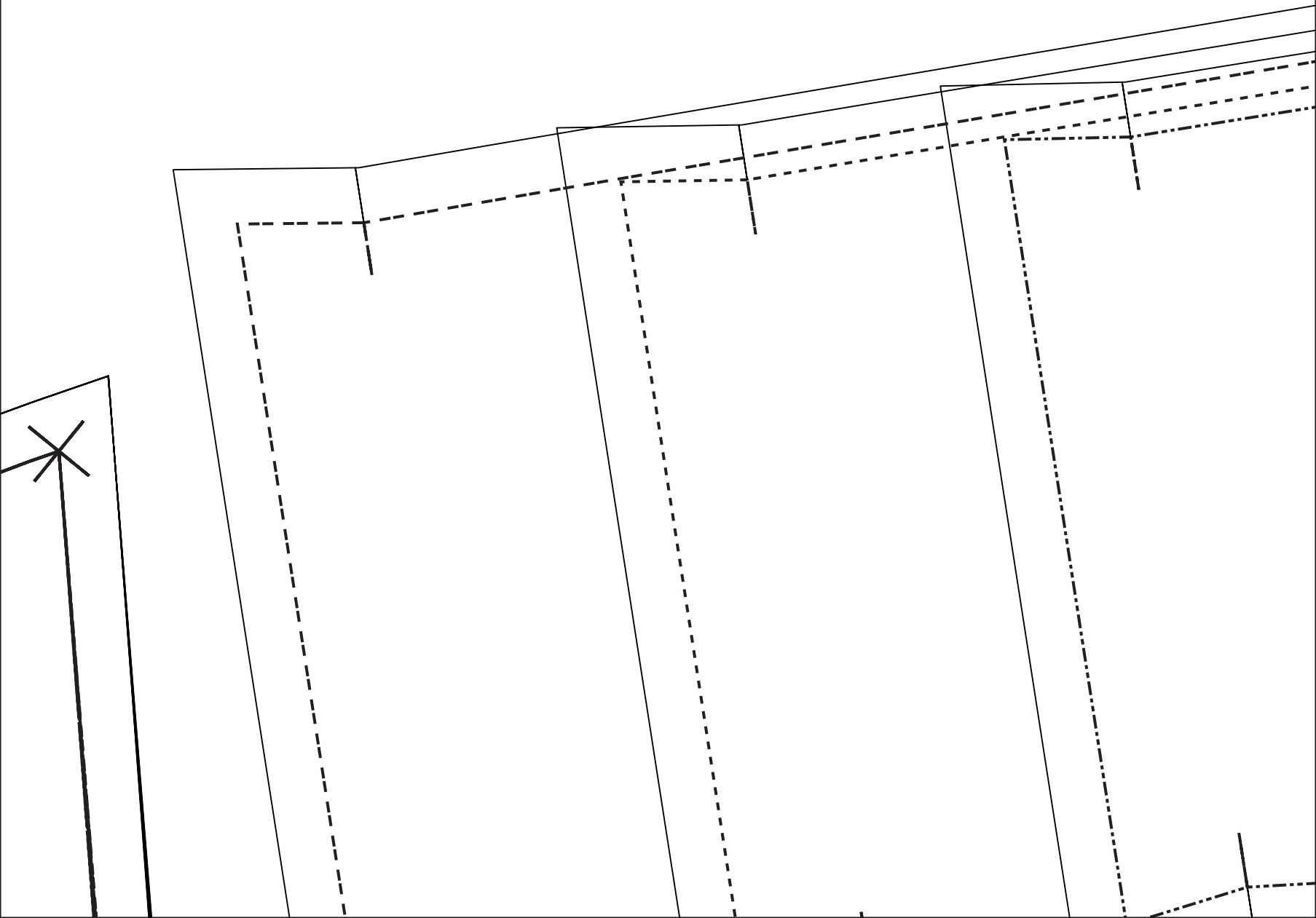

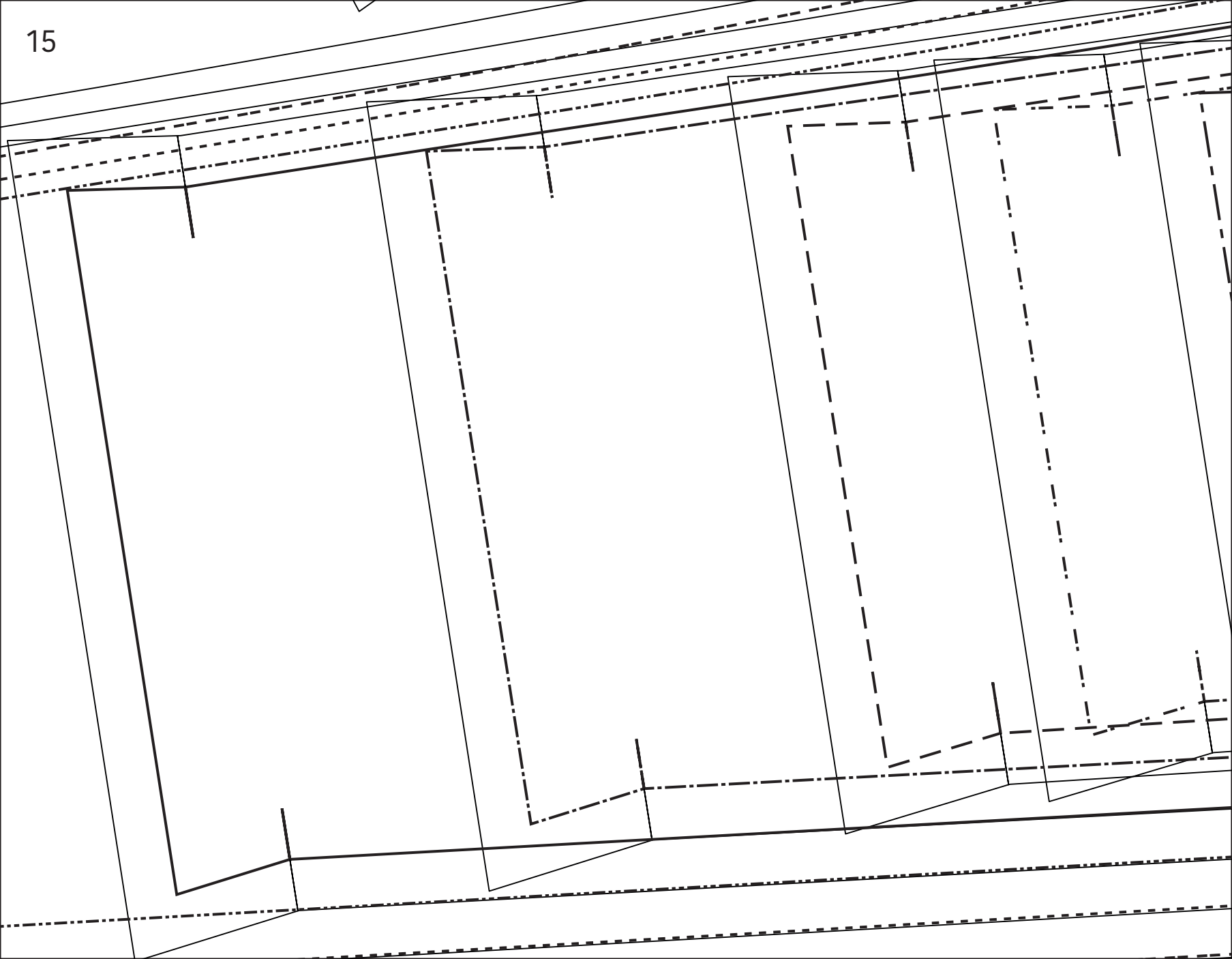

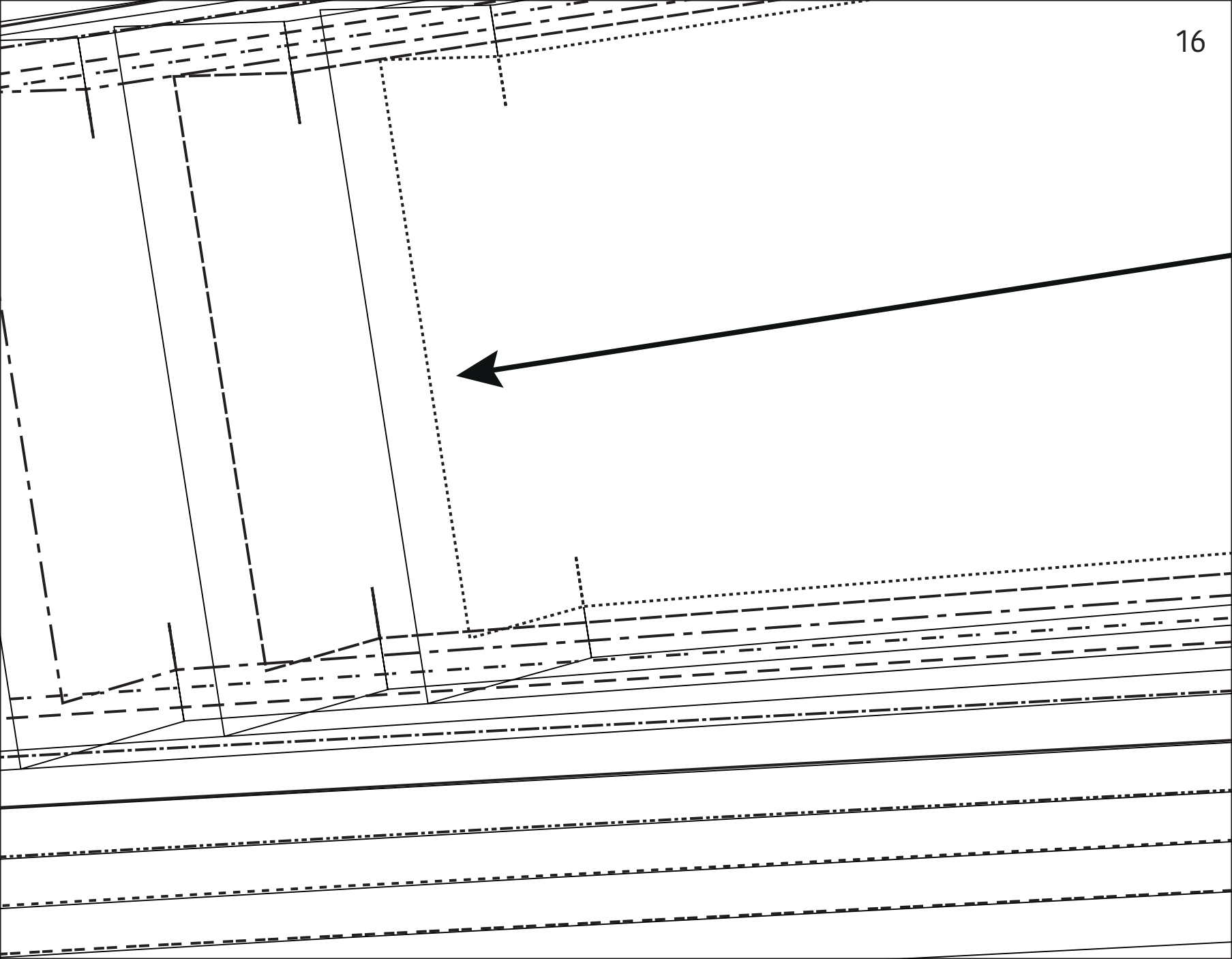



A

