

# Nicole

## Blazer

### Maten / Tailles / Sizes / Größen:

.....	30
-----	32
-----	34
- . - . - . - . - . - .	36
-----	38
-----	40
-----	42
-----	44
- . - . - . - . - . - .	46
-----	48

Controlevierkant / Carré de controle  
/ Test square / Kontrollquadrat

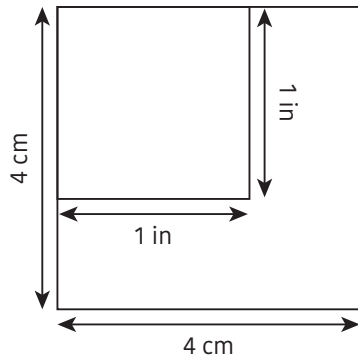

### Patroondelen / Pièces du patron / Pattern pieces / Schnittteile:

- A** voorpand boven / devant haut /  
top front panel / oberes Vorderteil
- B** voorpand onder / devant bas /  
bottom front panel /  
unteres Vorderteil
- C** rugpand boven / devant haut /  
top back panel / oberes Rückenteil
- D** rugpand onder / dos bas /  
bottom back panel /  
unteres Rückenteil
- E** bovenmouw / haut de manche /  
top sleeve / oberer Ärmel
- F** ondermouw / bas de manche /  
bottom sleeve / onderer Ärmel
- G** kraag / col / collar / Kragen
- H** tegenzak / contre-poche /  
inner pocket bag / Taschenfutter
- H'** zak / poche / pocket / Tasche
- I** beleg VP boven / parementure DV  
haut / top facing FP /  
Besatz VT oben
- J** beleg VP onder / parementure DV bas /  
bottom facing FP /  
Besatz VT unten
- K** beleg RP / parementure DS /  
facing BP / Besatz RT

Patroonschema / Schéma du Patron / Pattern Diagram /  
Übersichtsplan zum Zusammenkleben

1	2	3	4	5	6
7	8	9	10	11	12
13	14	15	16	17	18
19	20	21	22	23	24
25	26	27	28	29	30
31	32	33	34	35	36
<del>37</del>	<del>38</del>	<del>39</del>	40	41	42

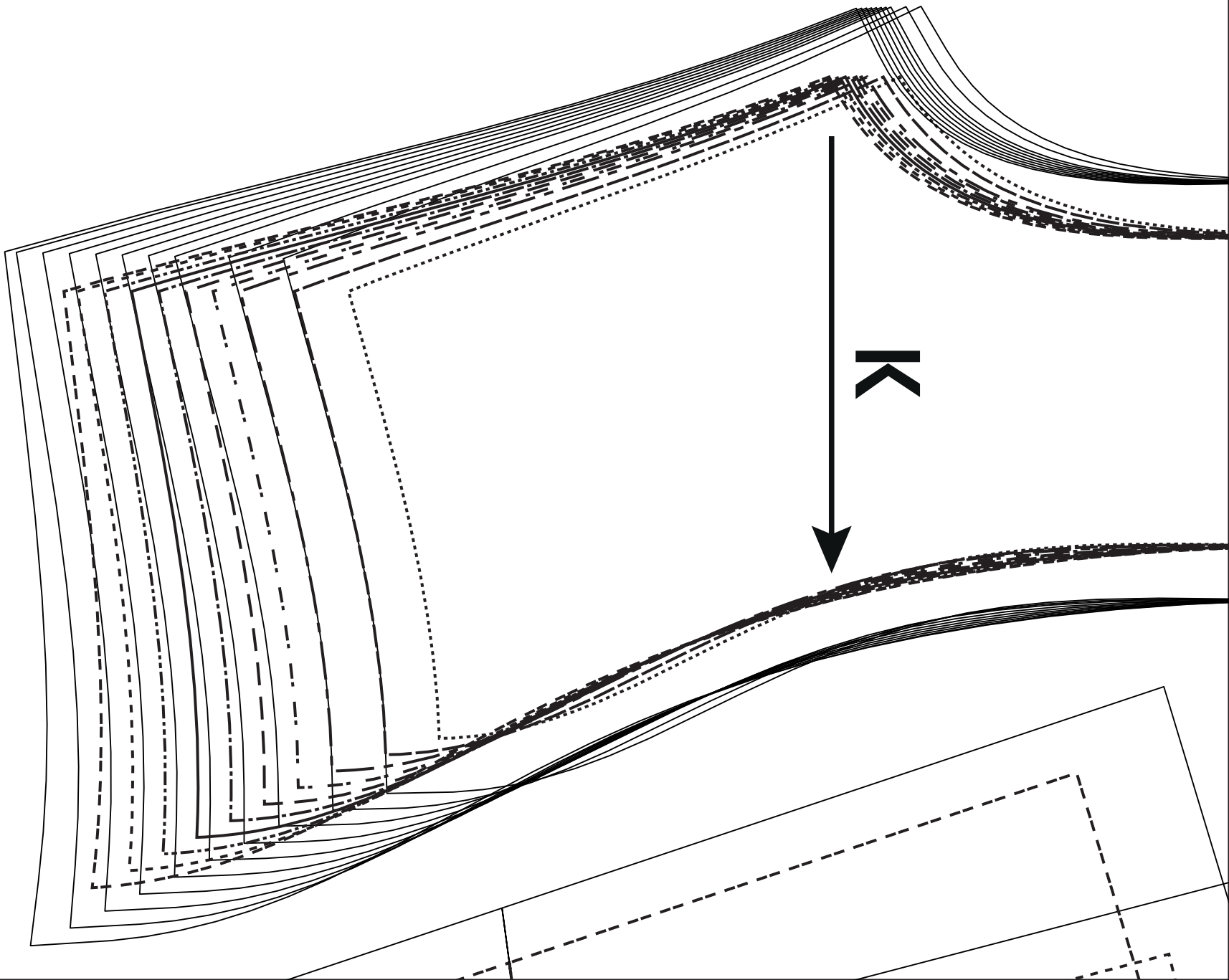

MR/MDS/CB/RM



D







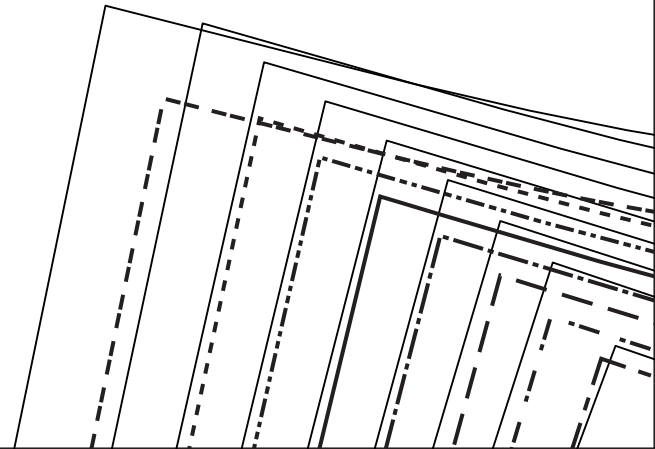
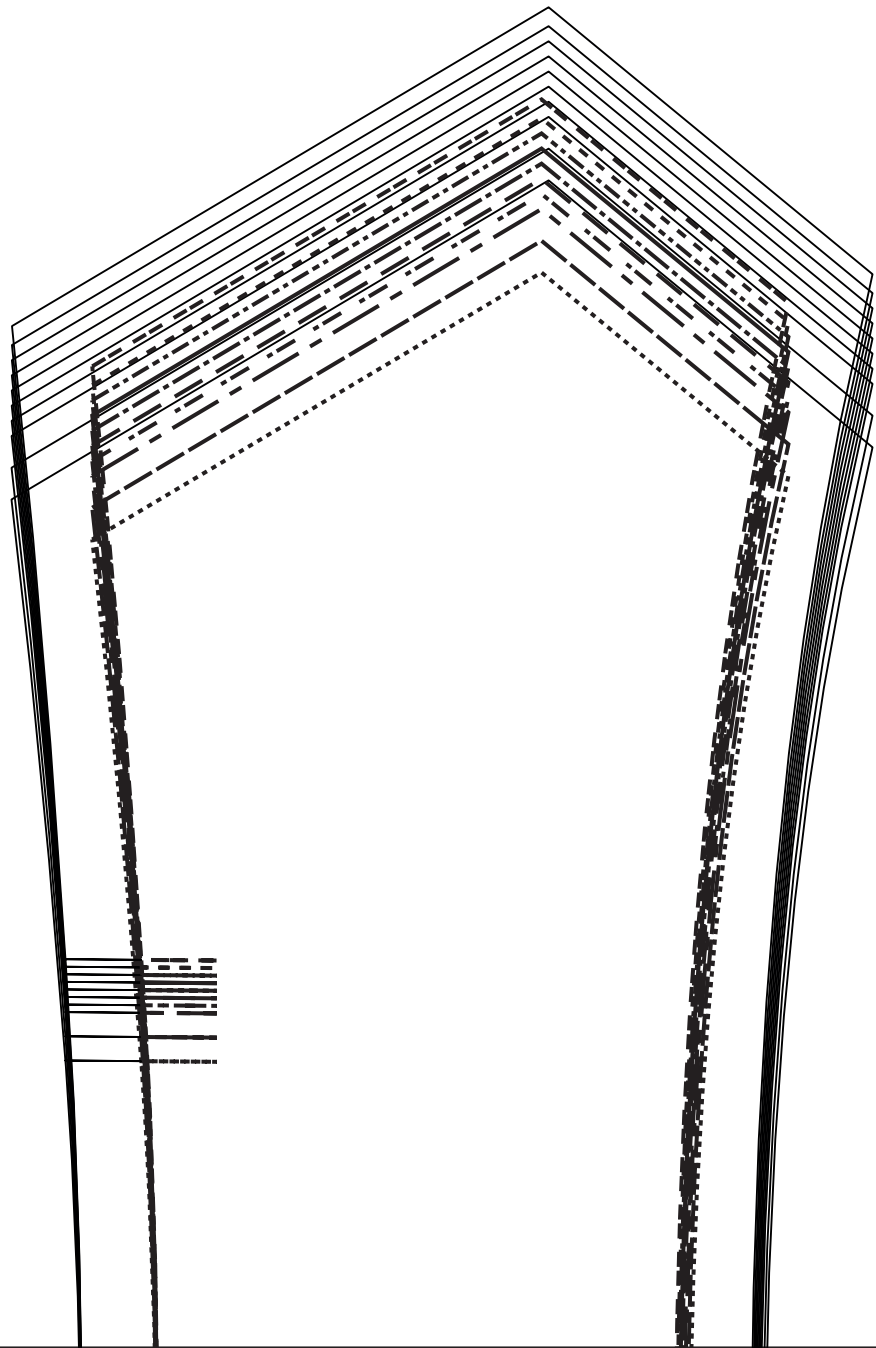

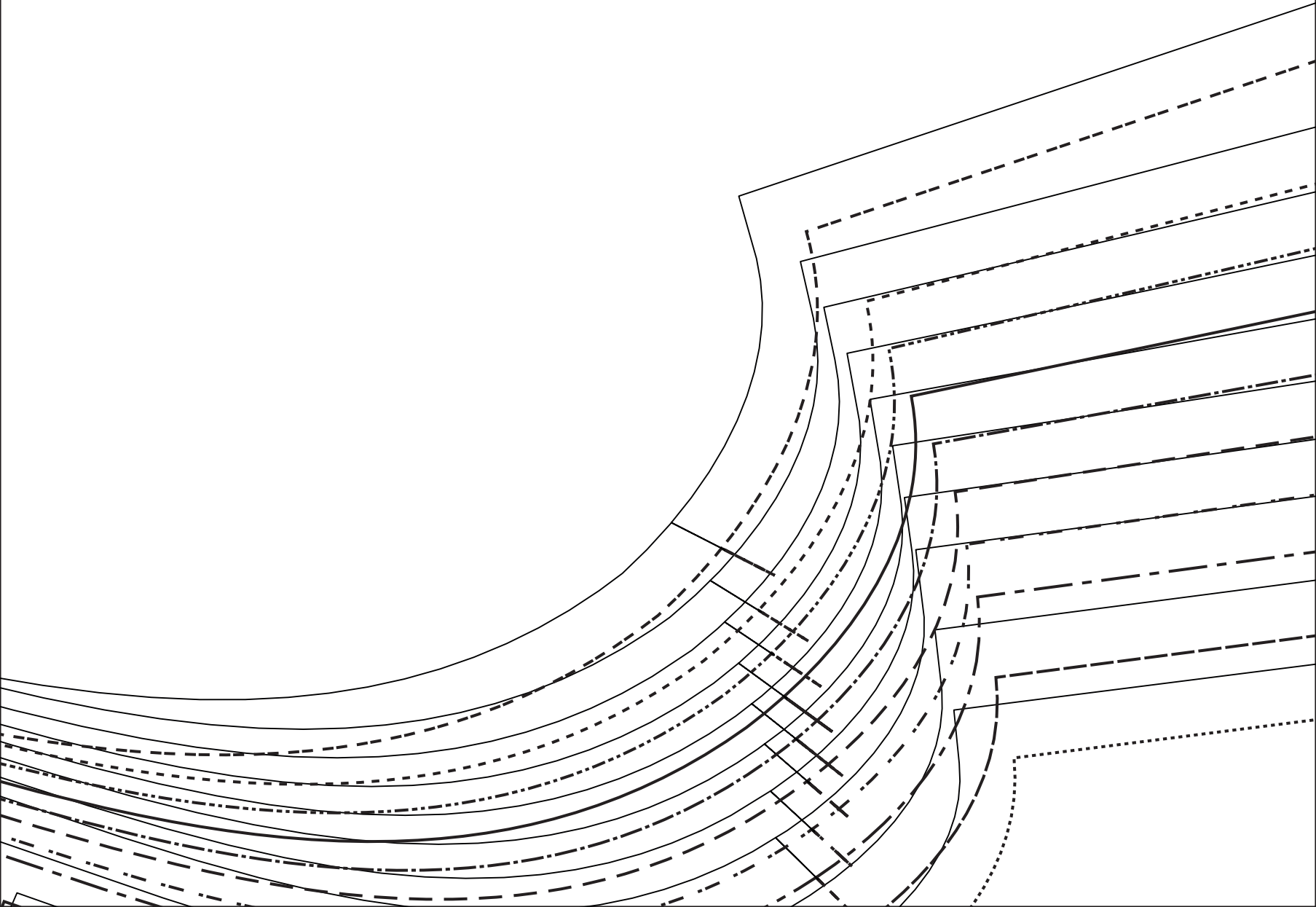



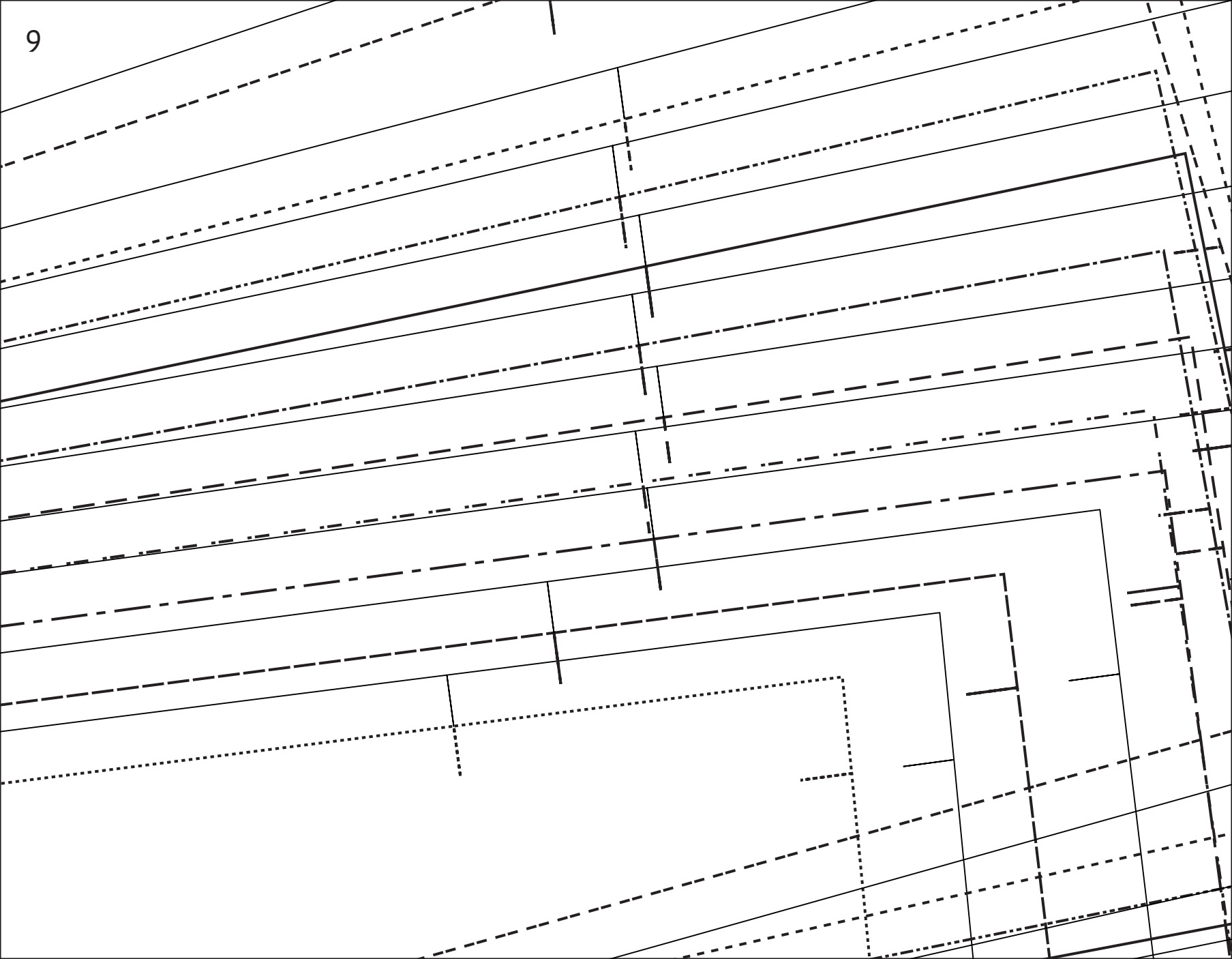

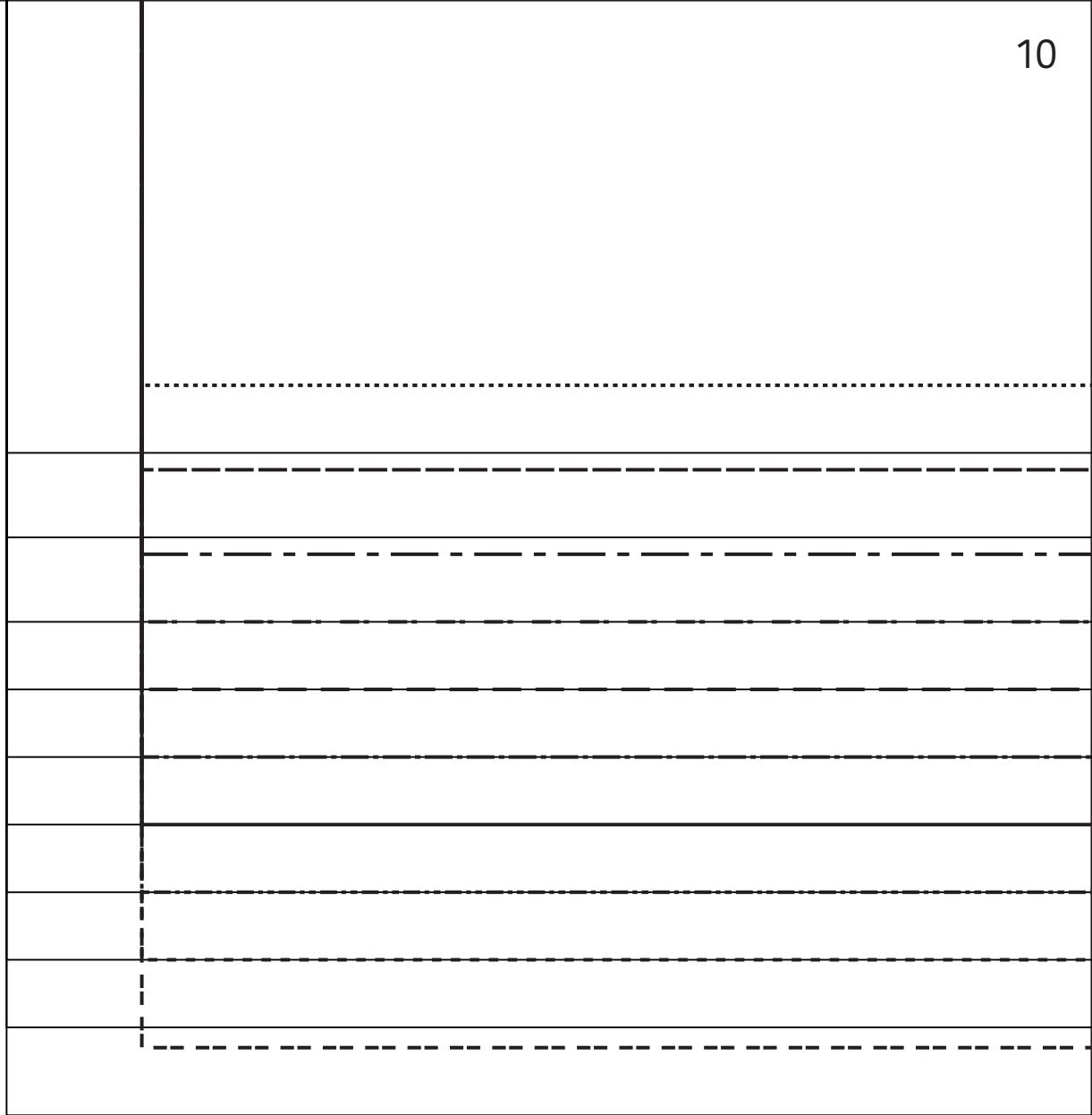
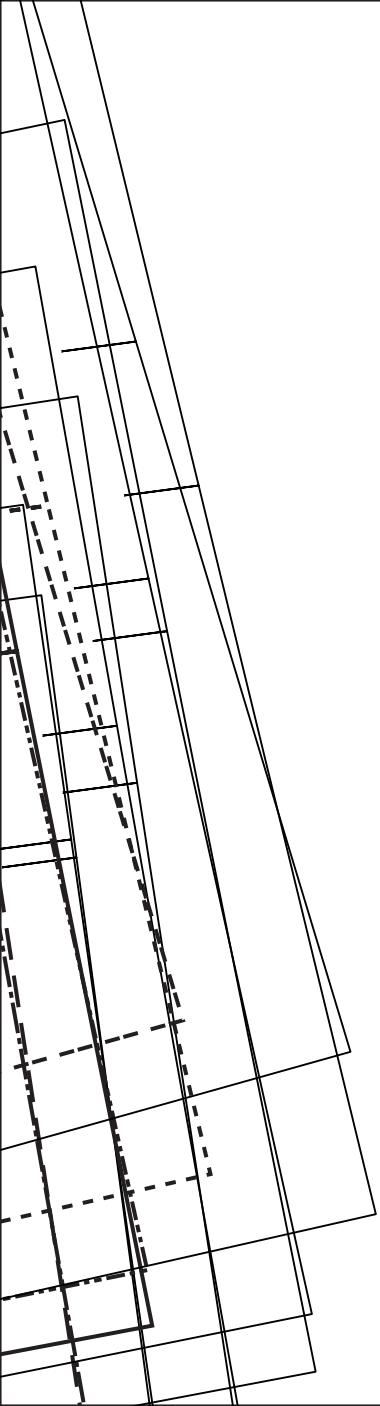

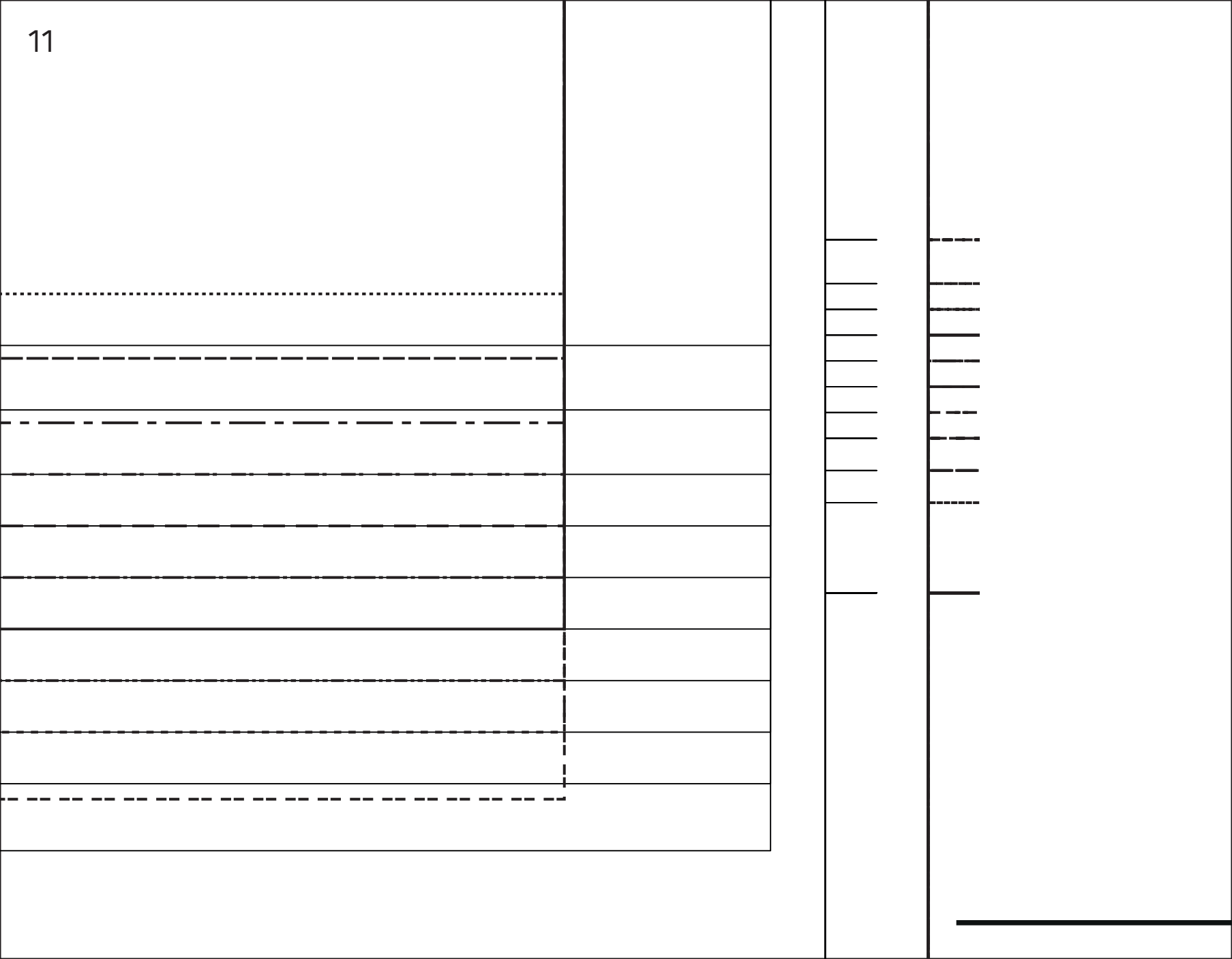

12



**B**



**G**



MR/MDS/CB/RM

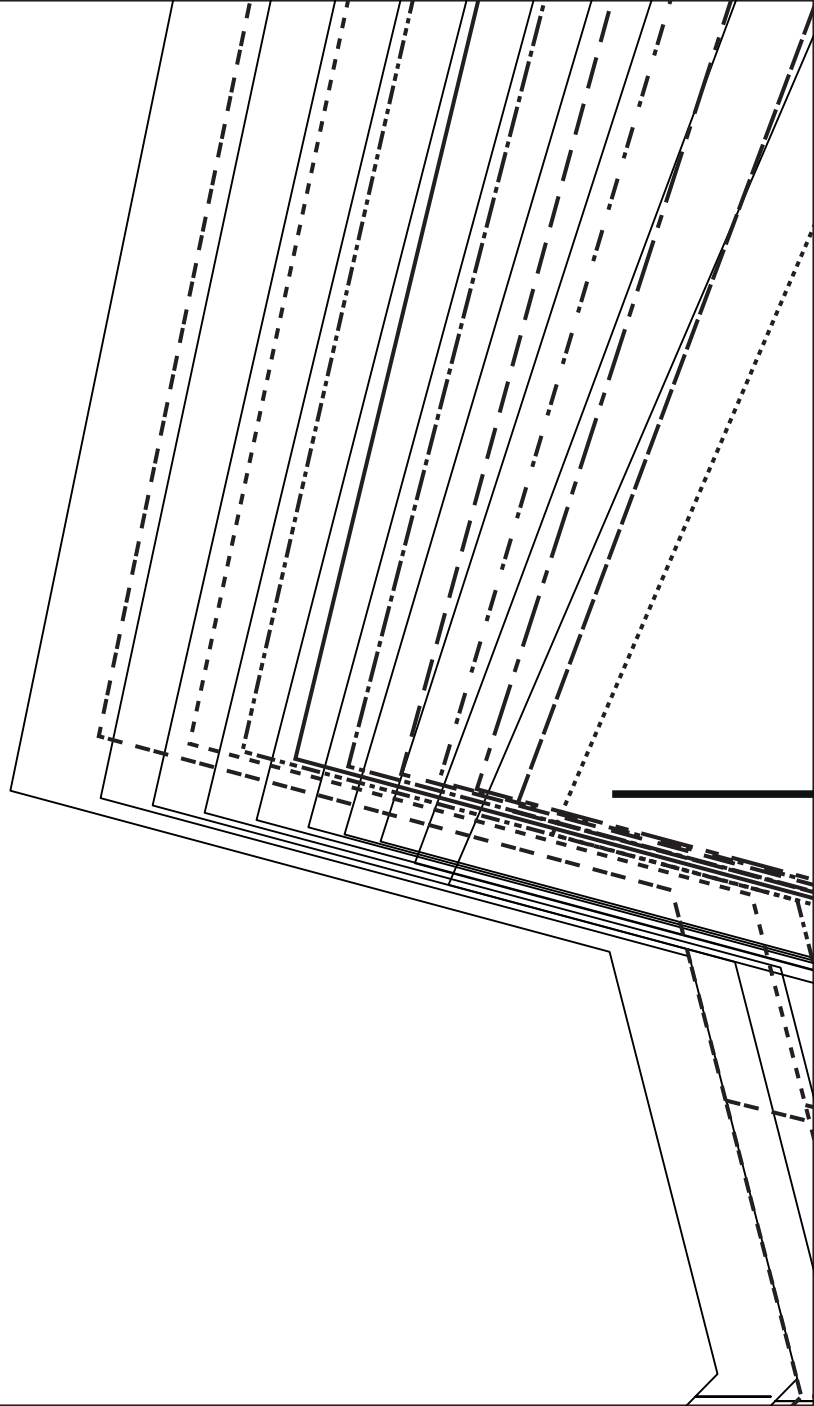
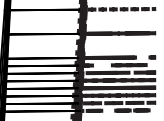

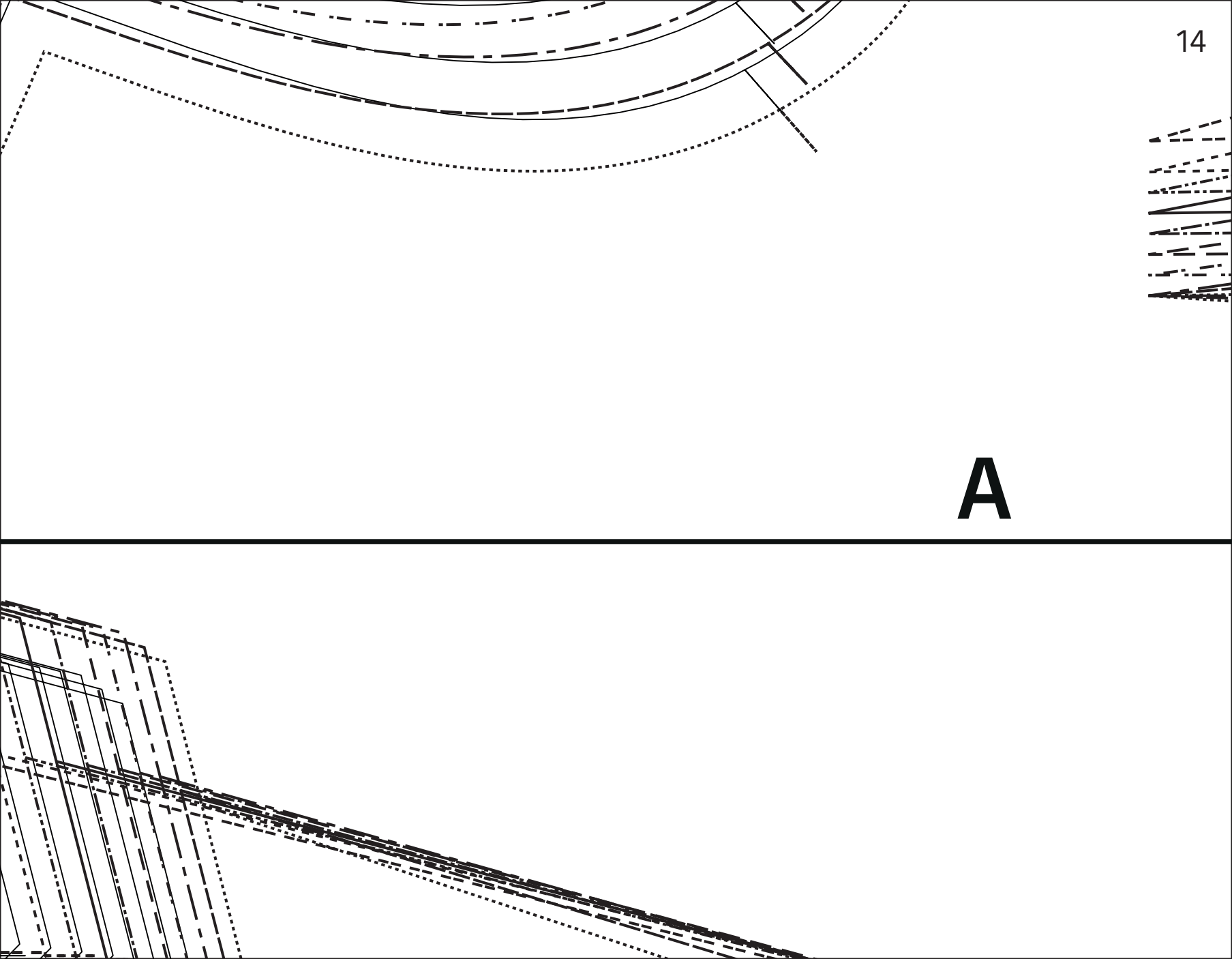

**A**

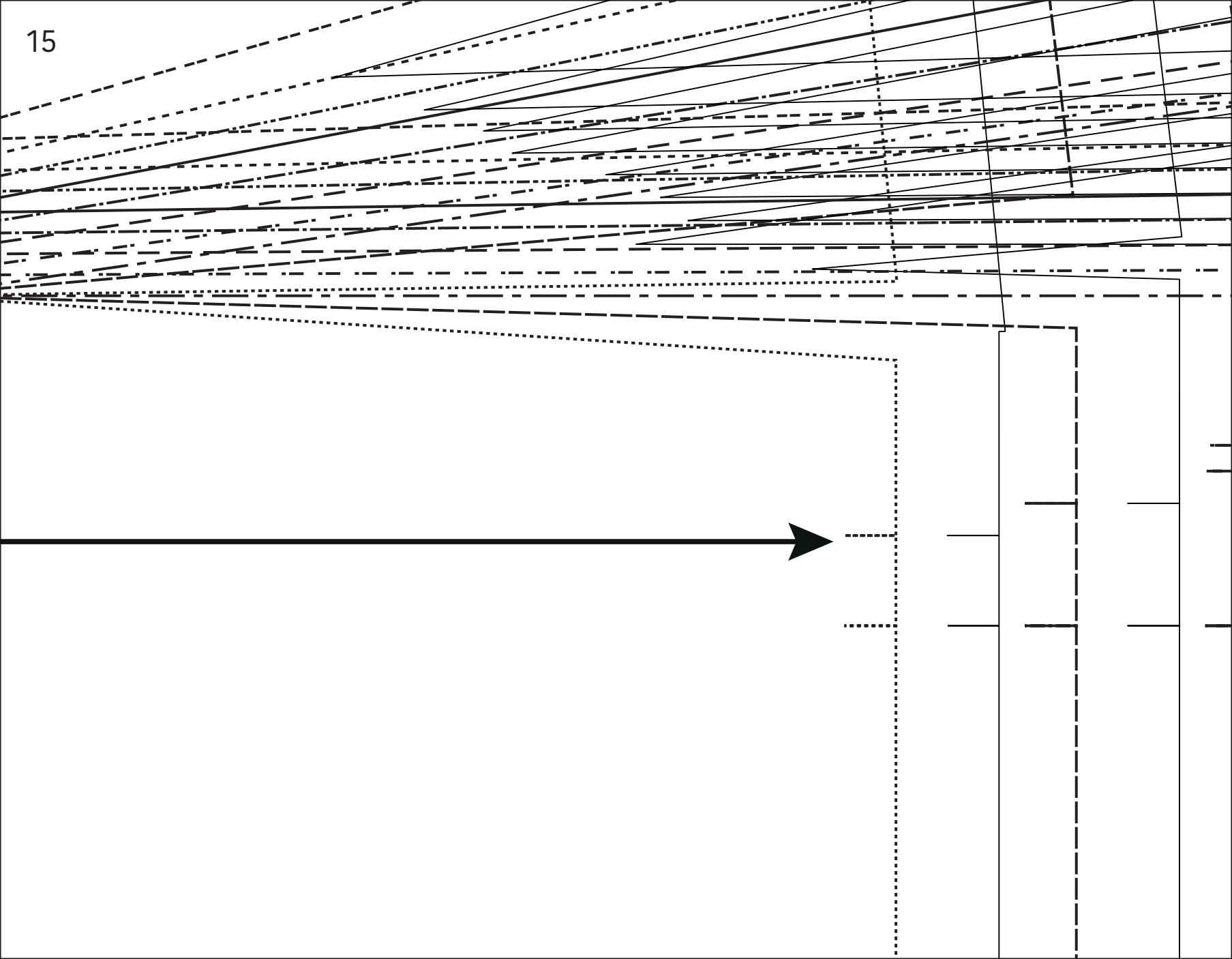

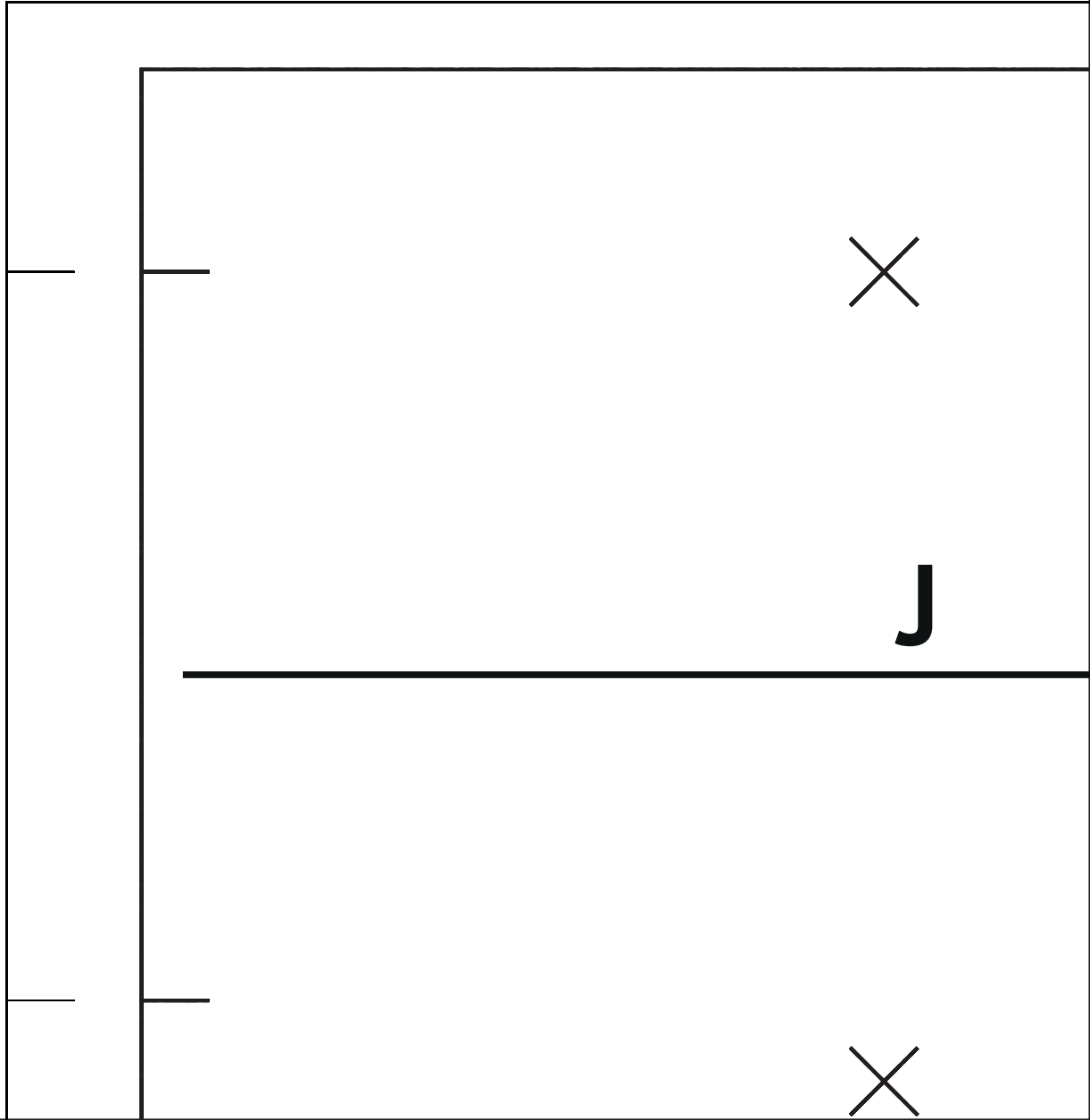
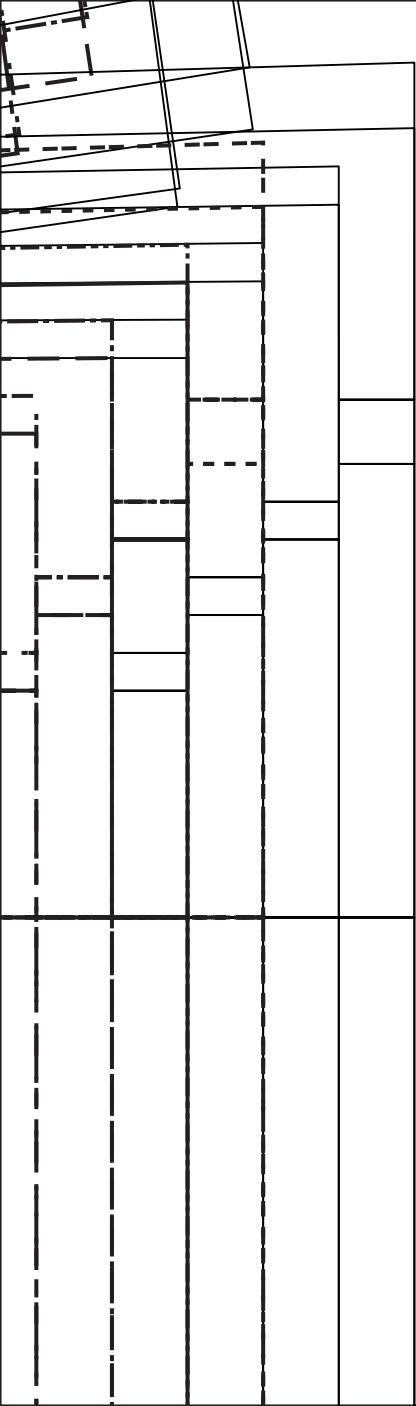



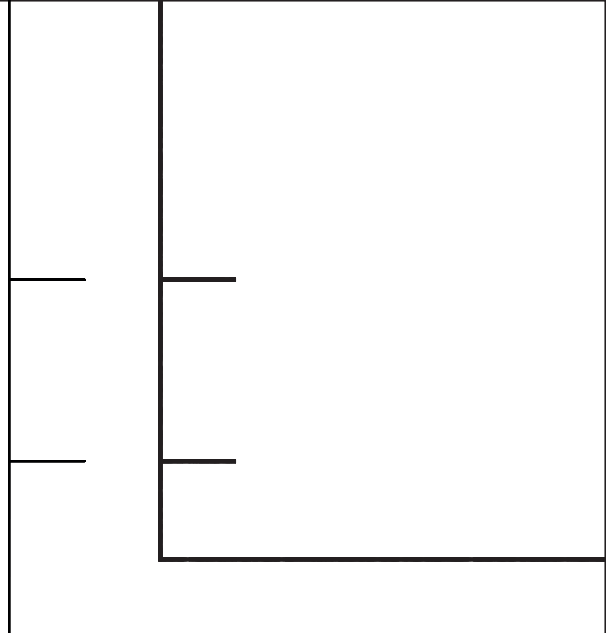
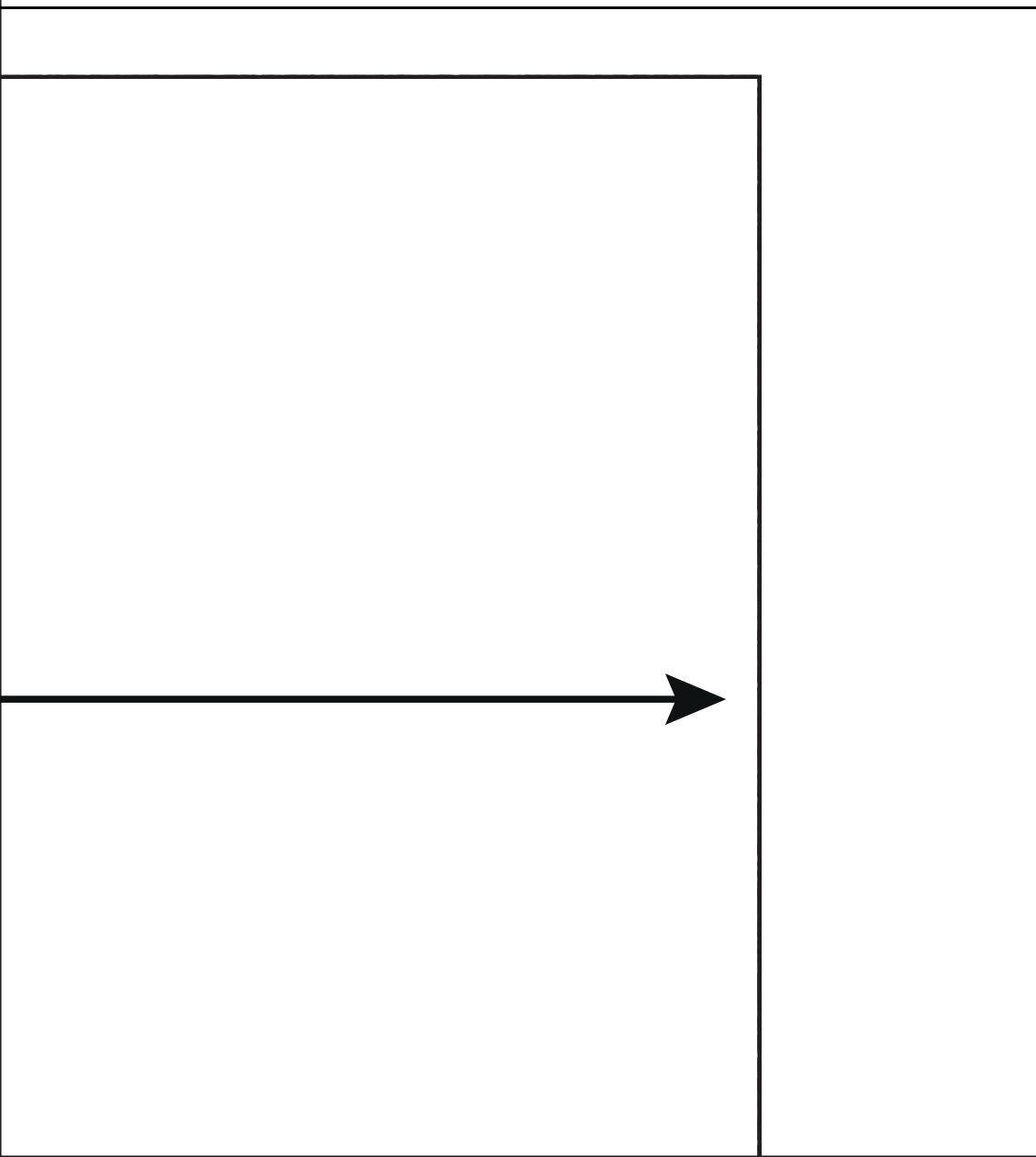

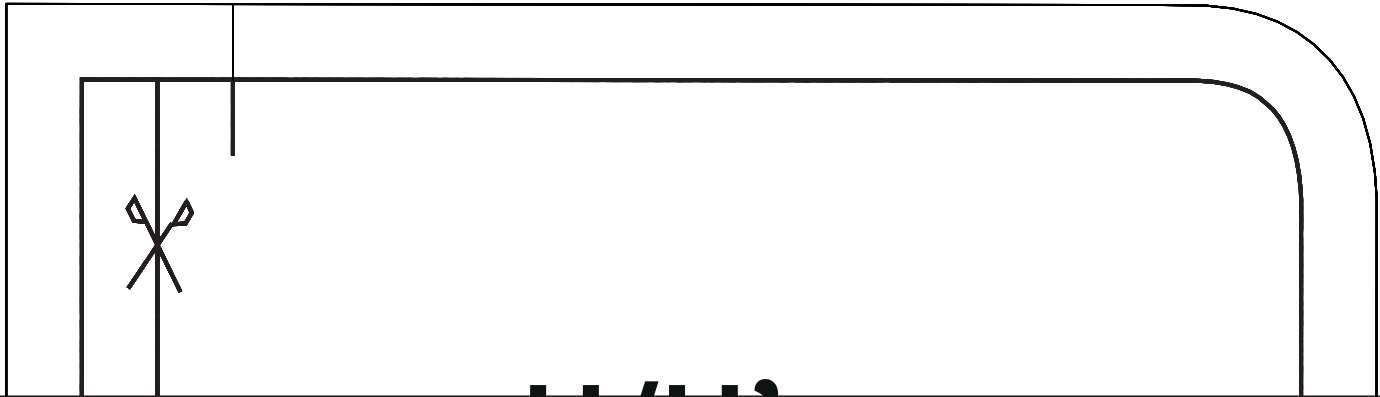

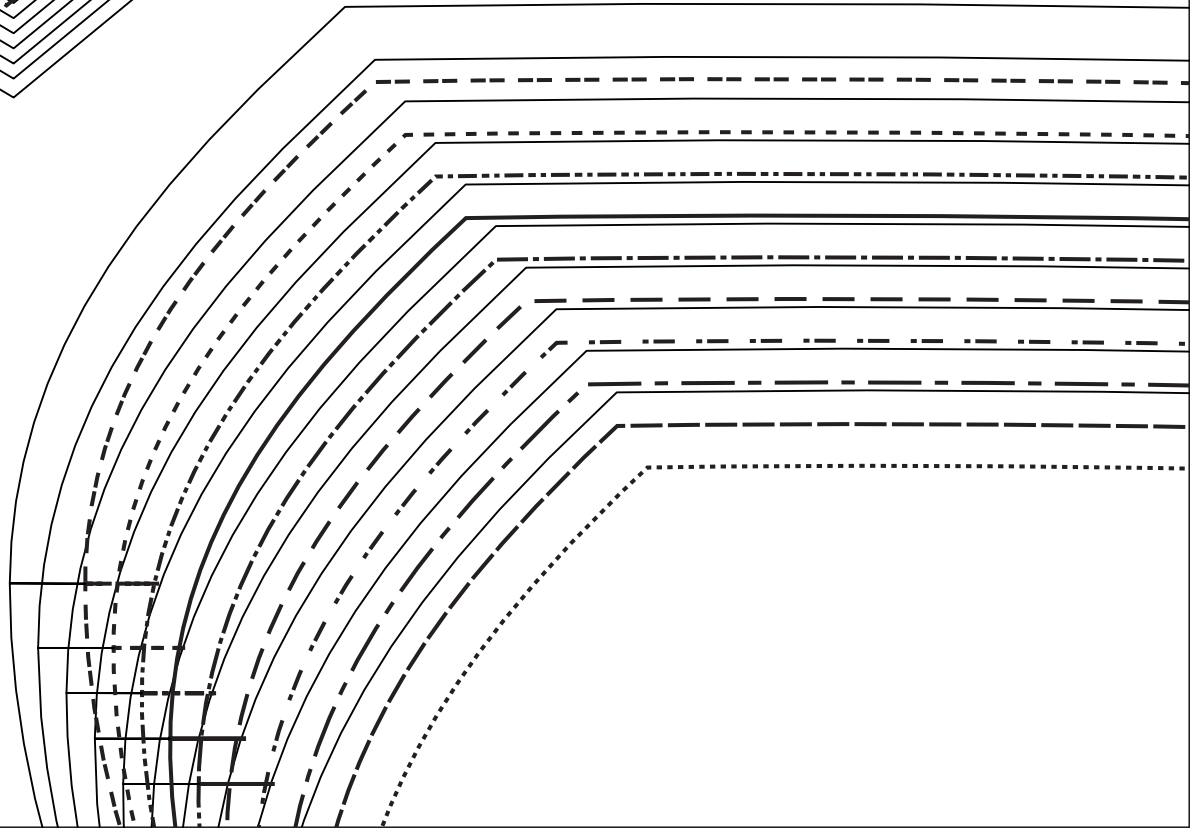
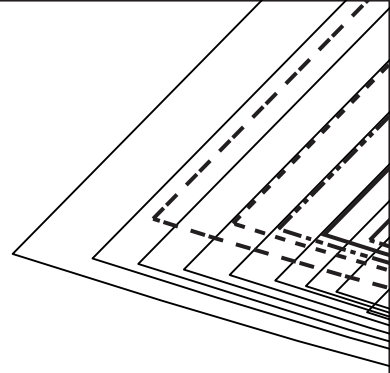
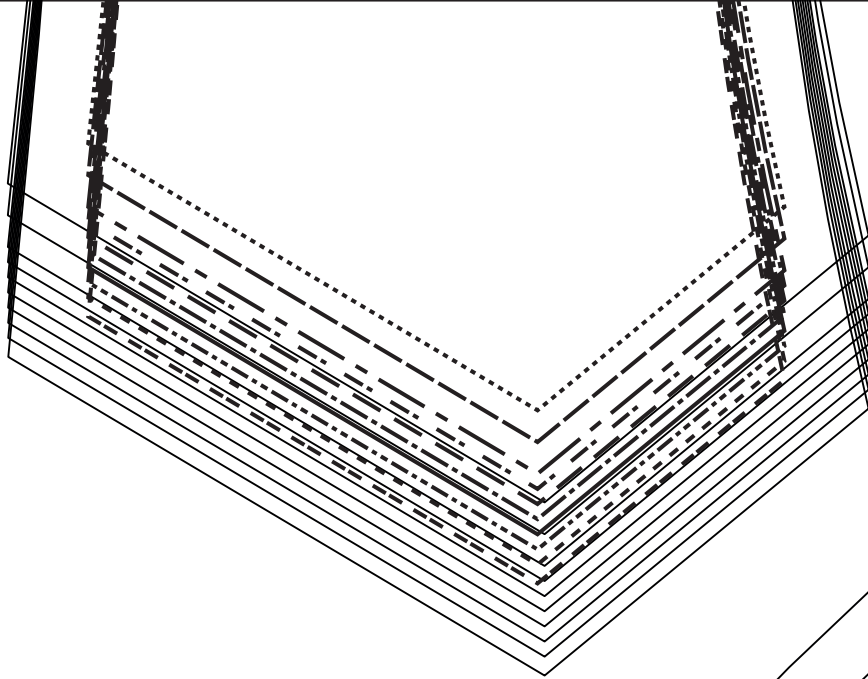

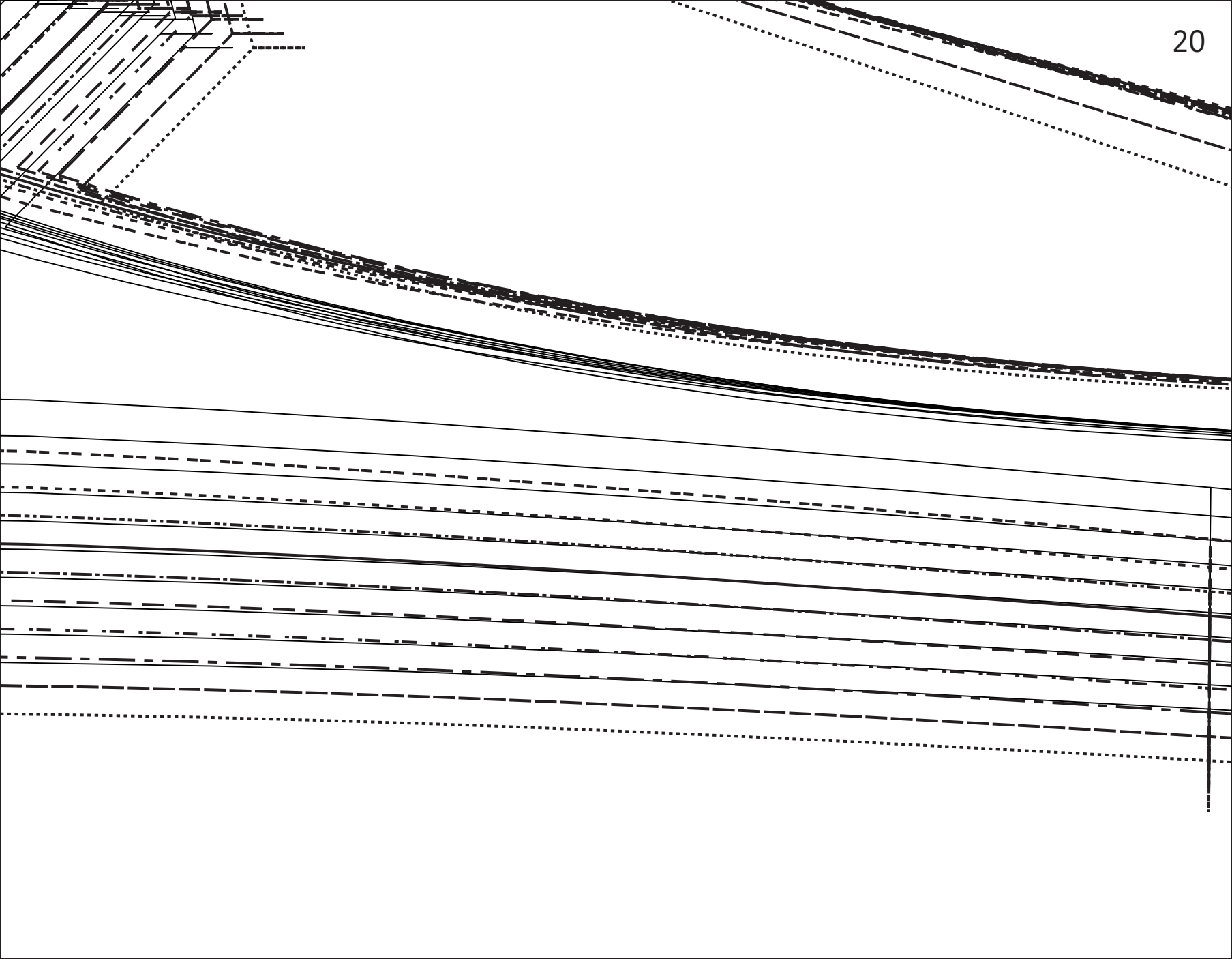

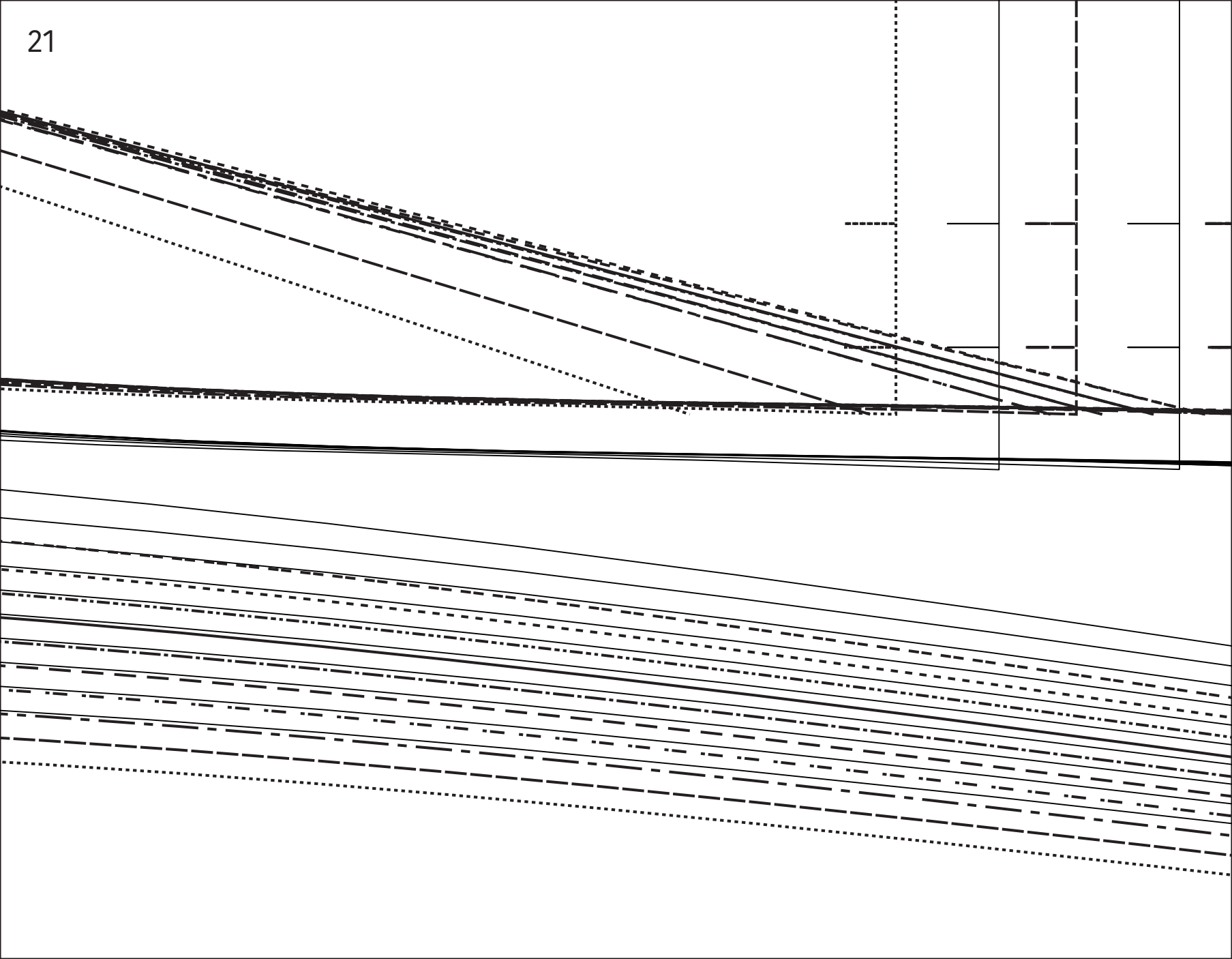

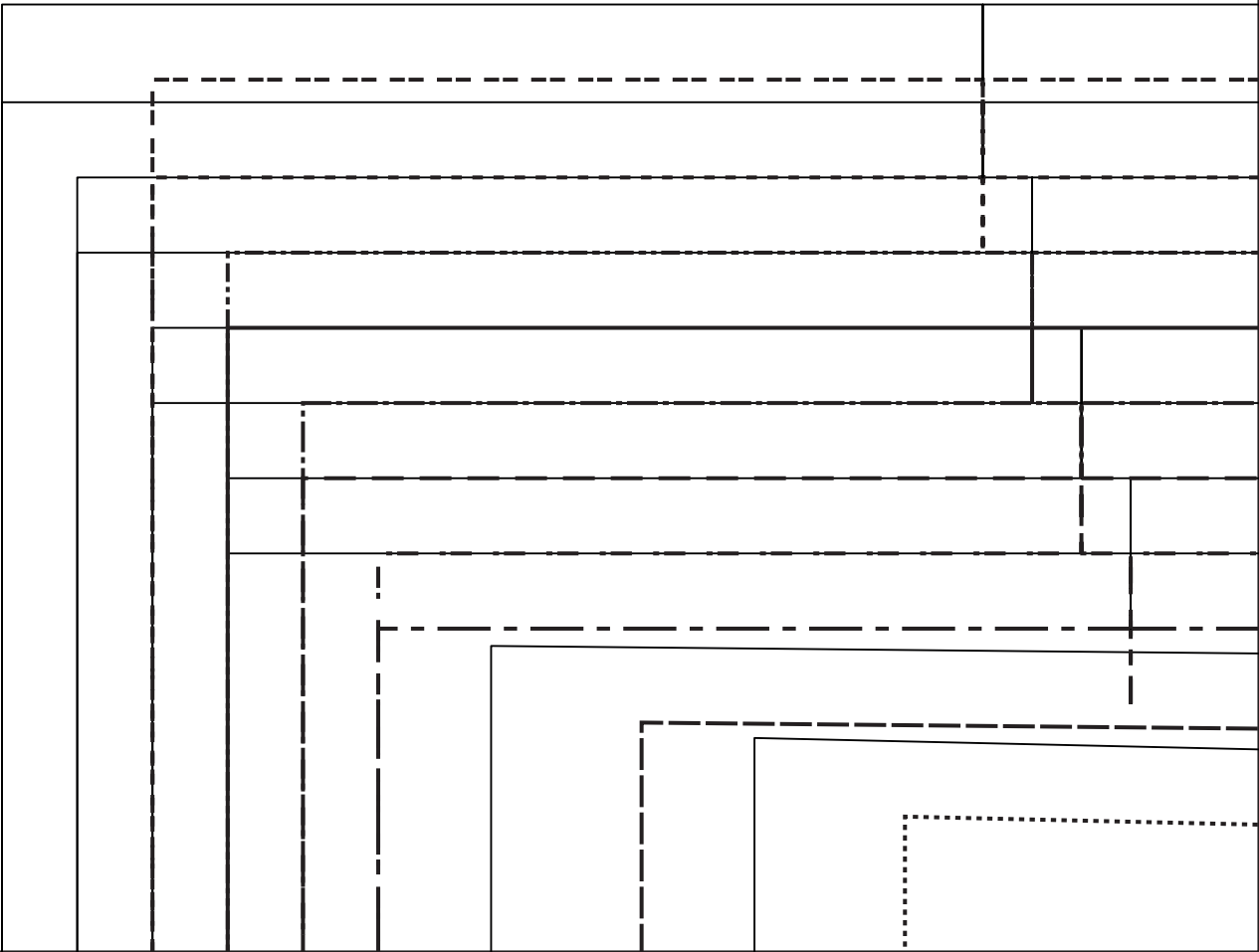
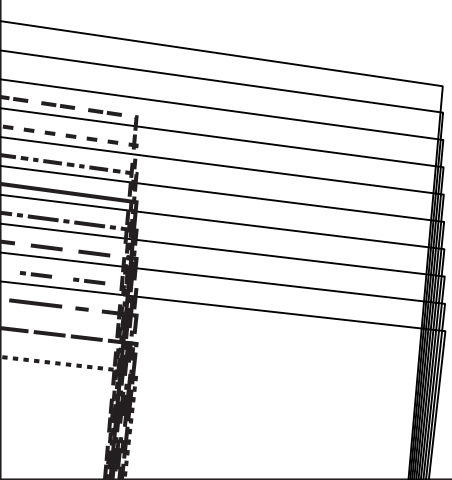
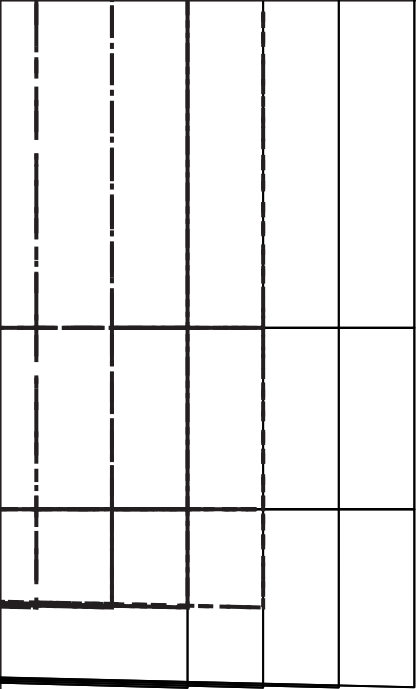

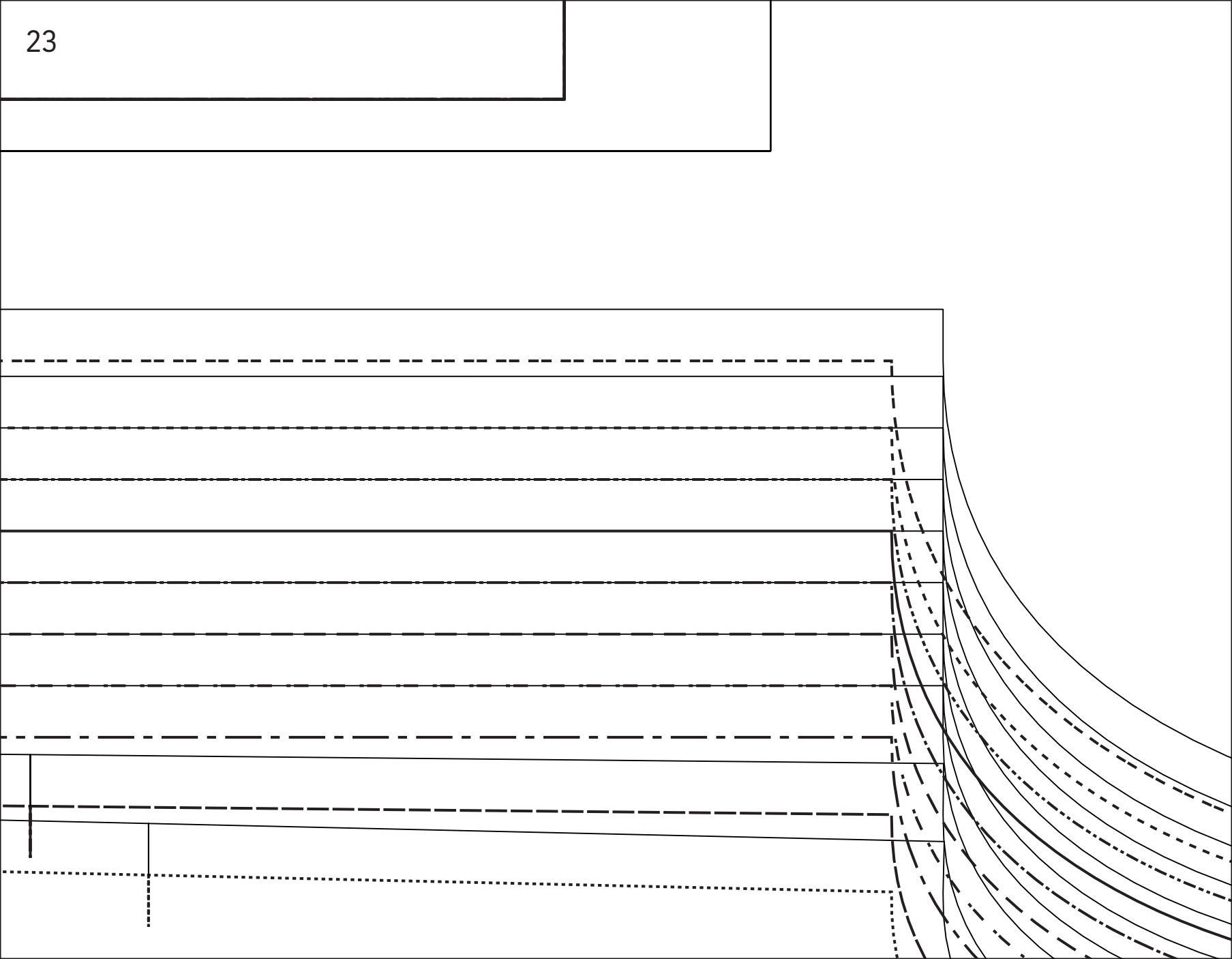

$H/H'$

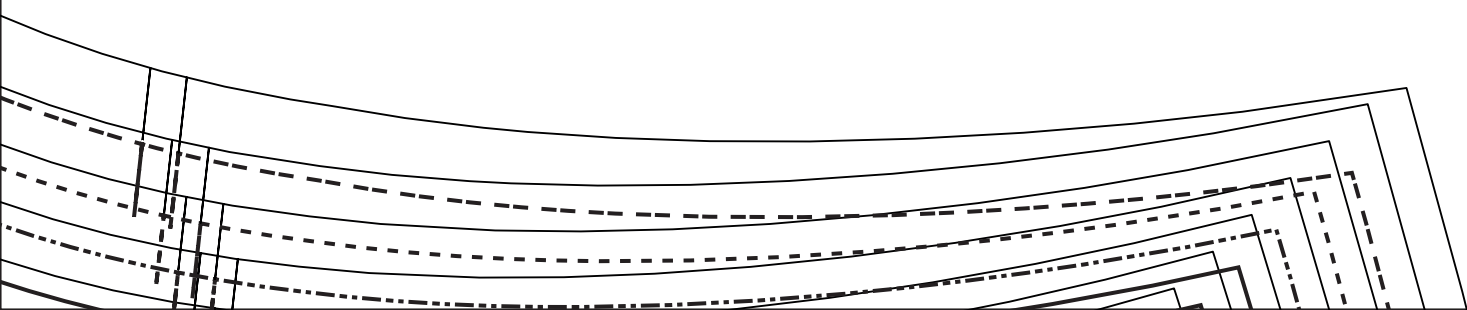



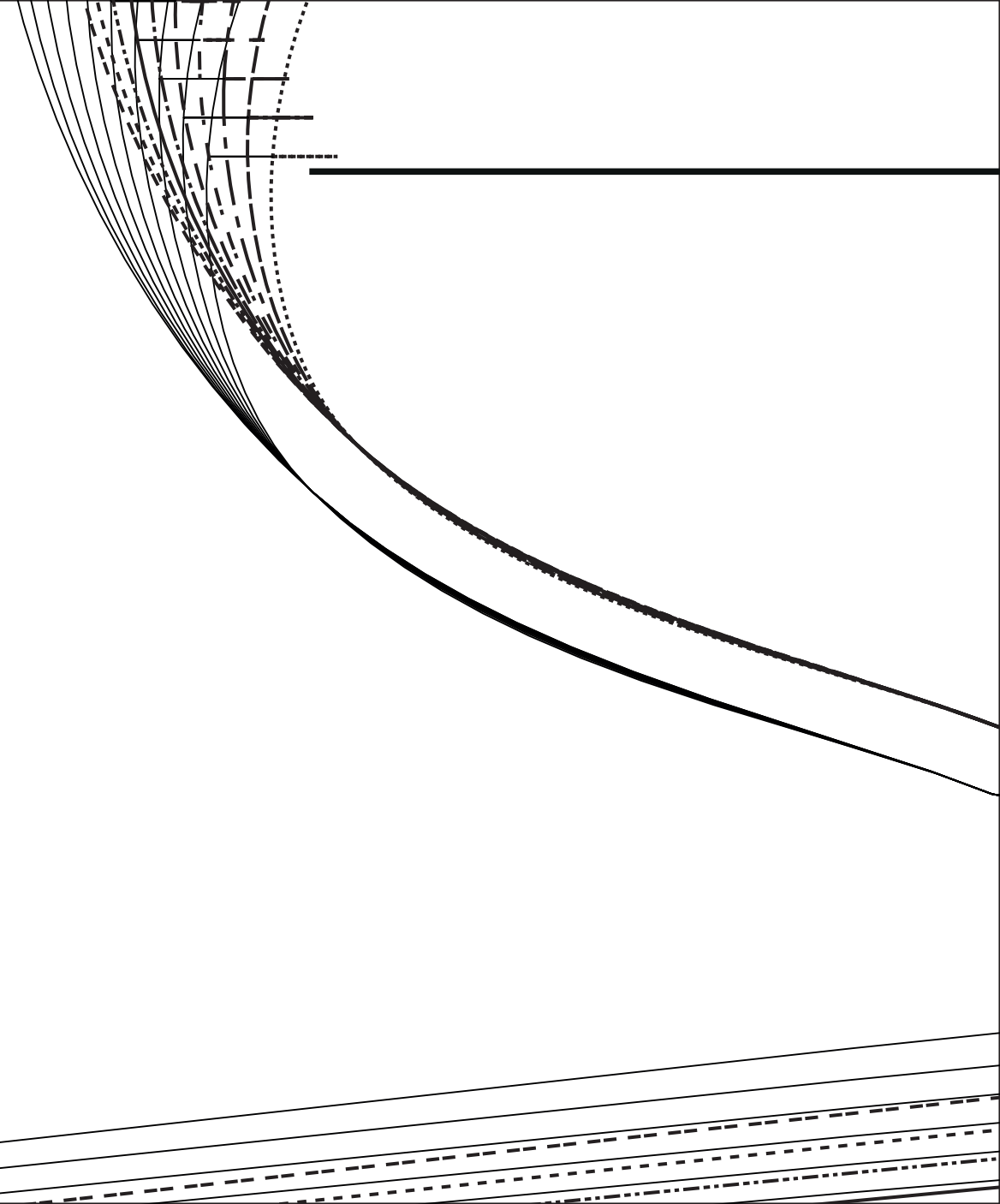

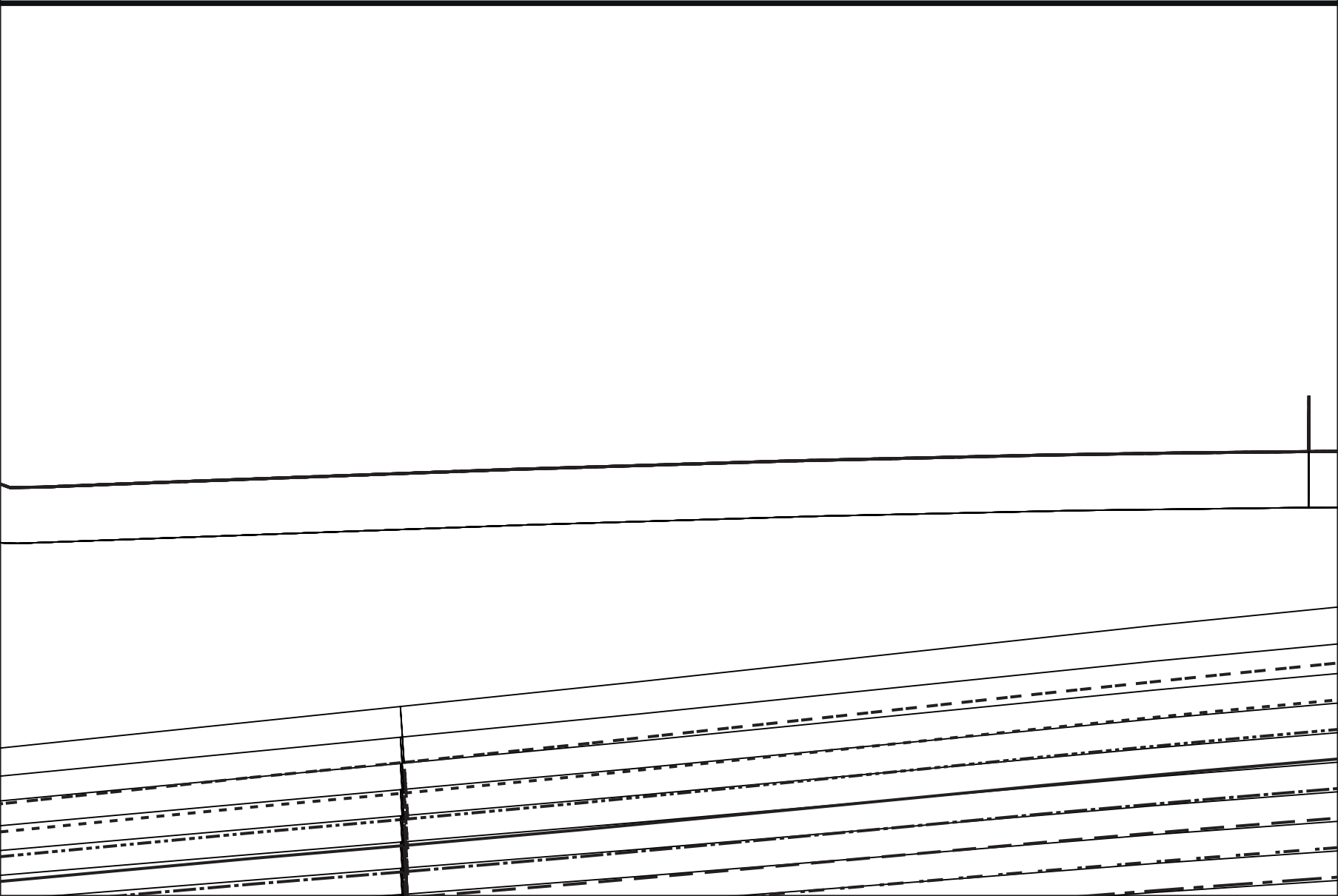

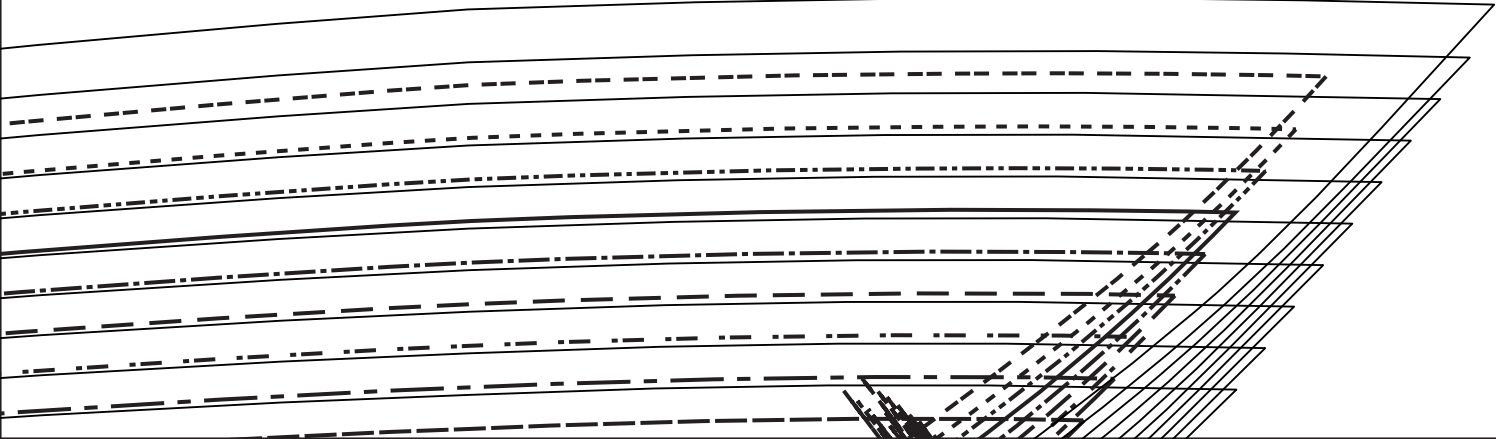

28

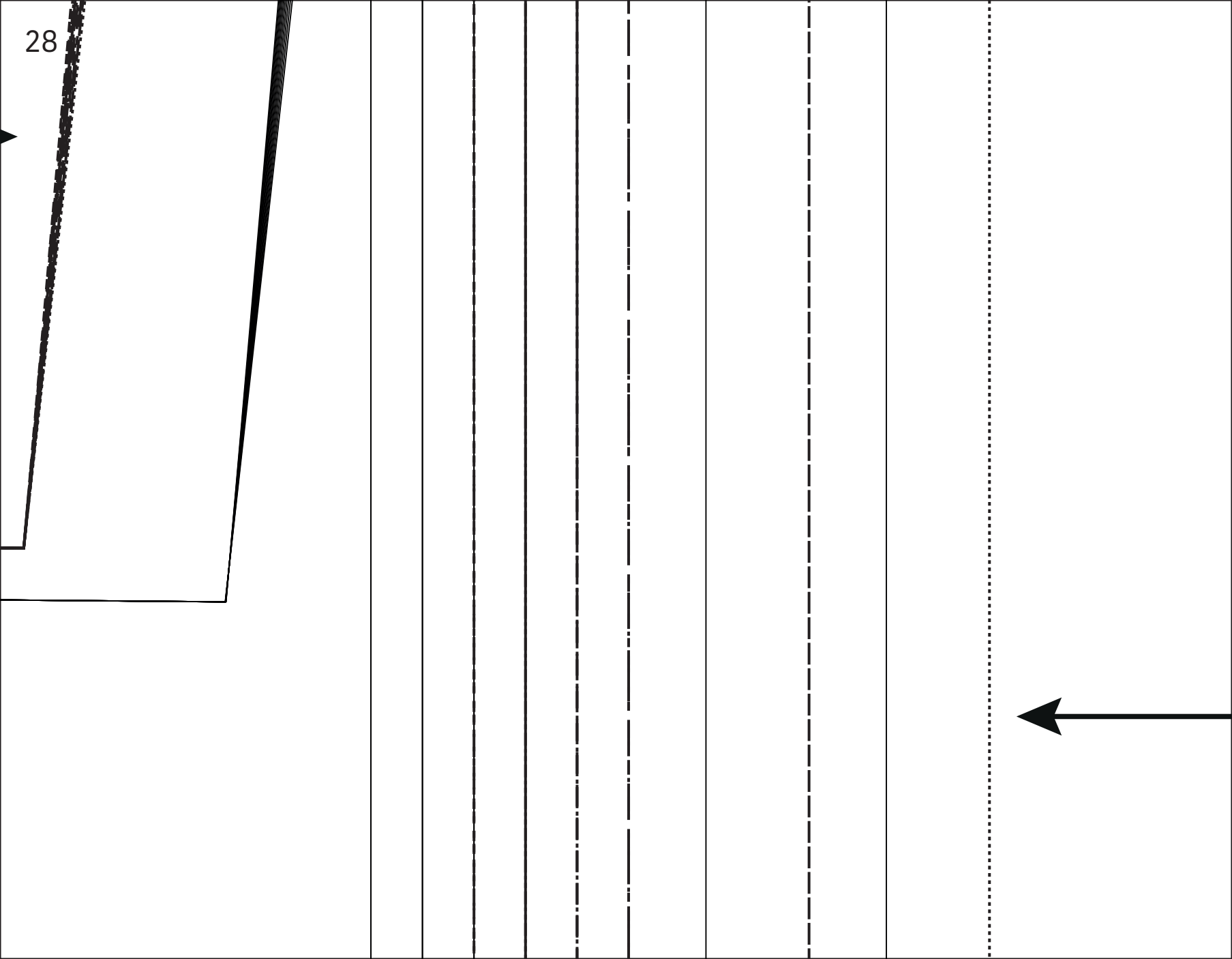

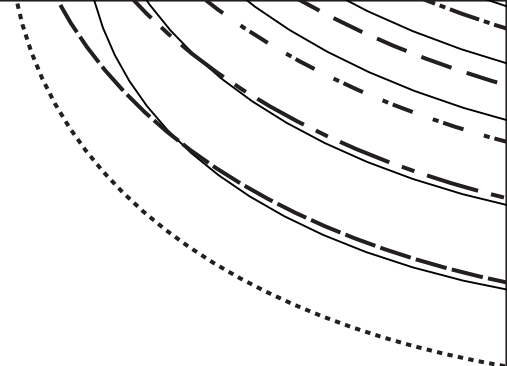

၂

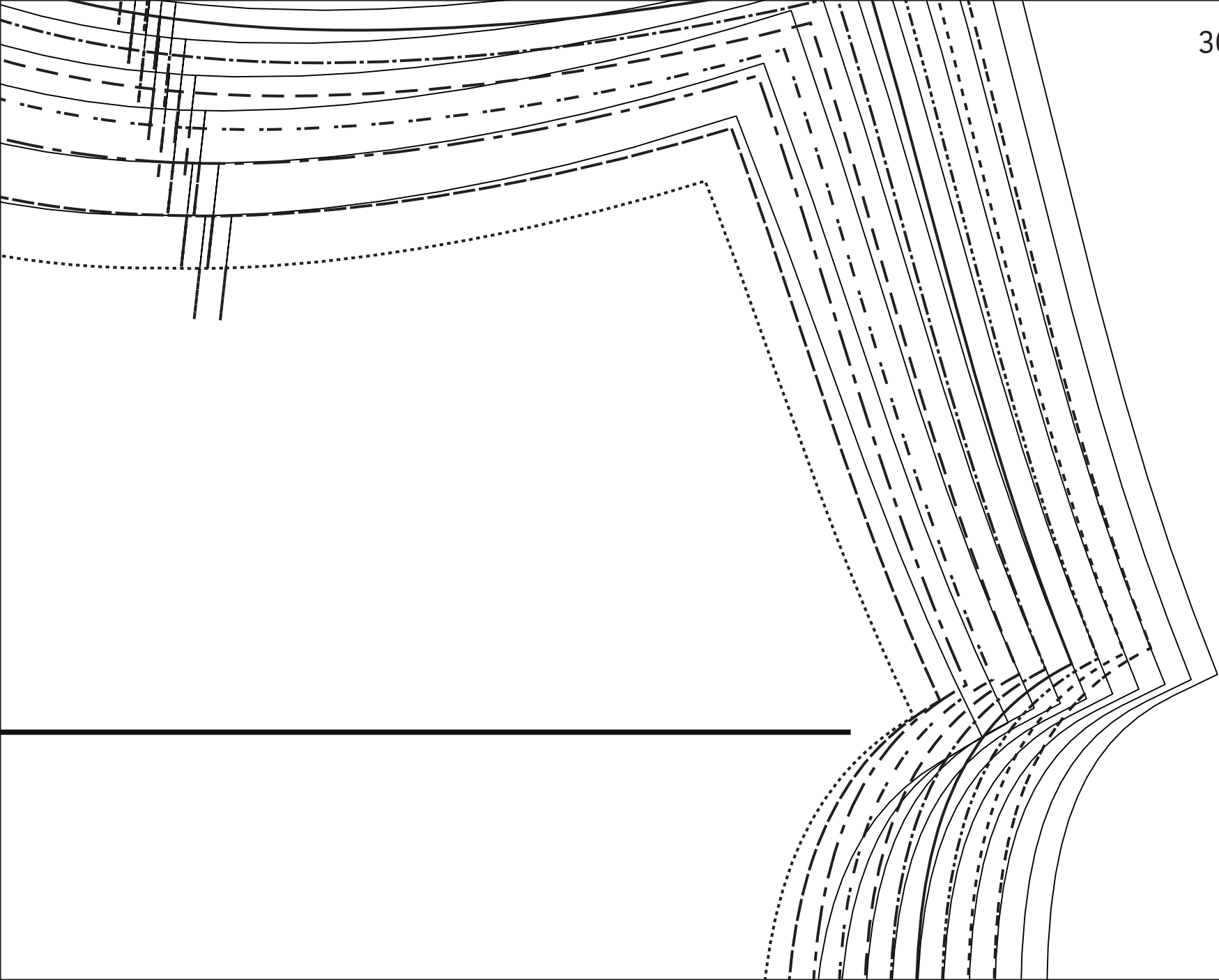

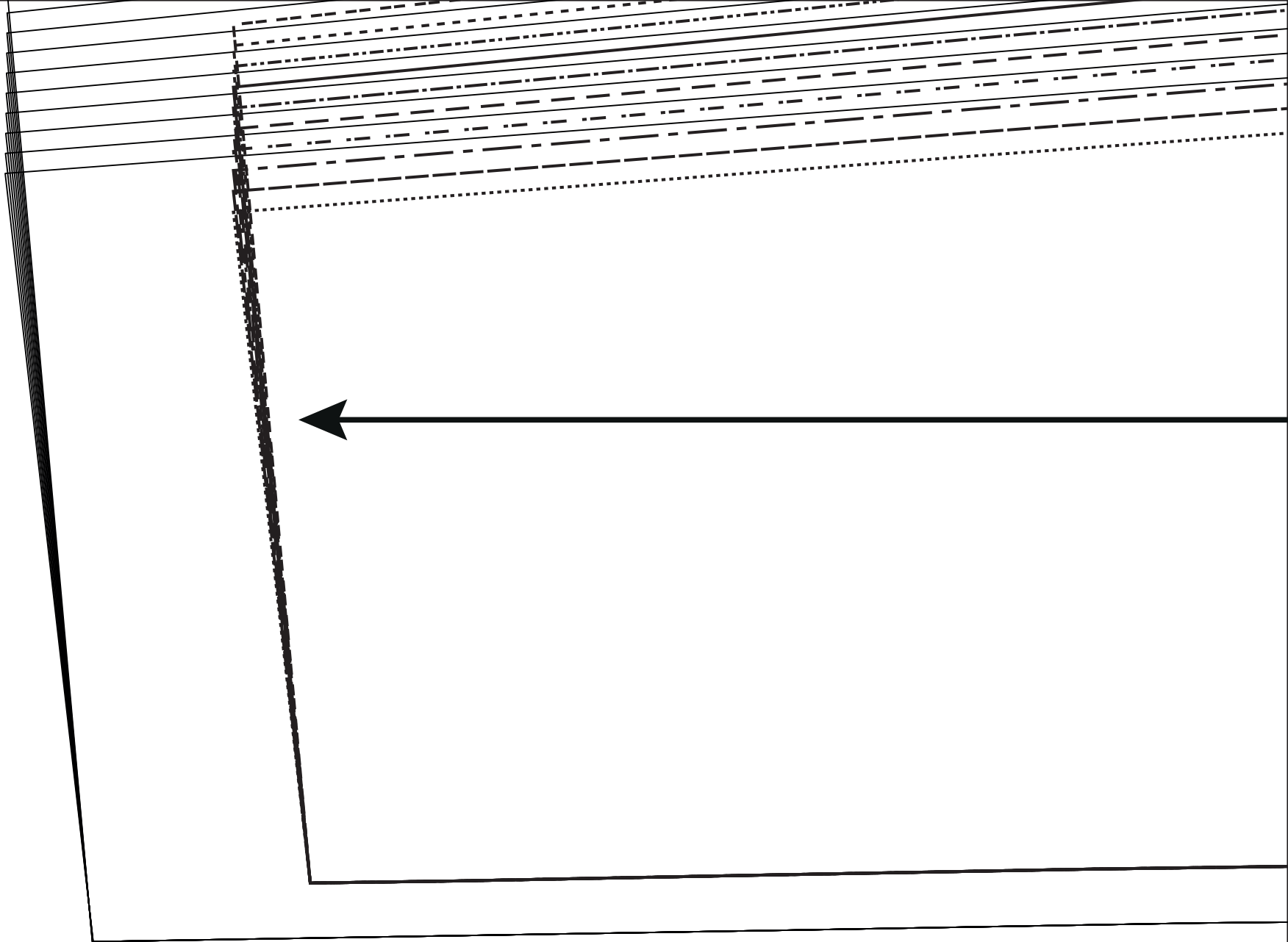

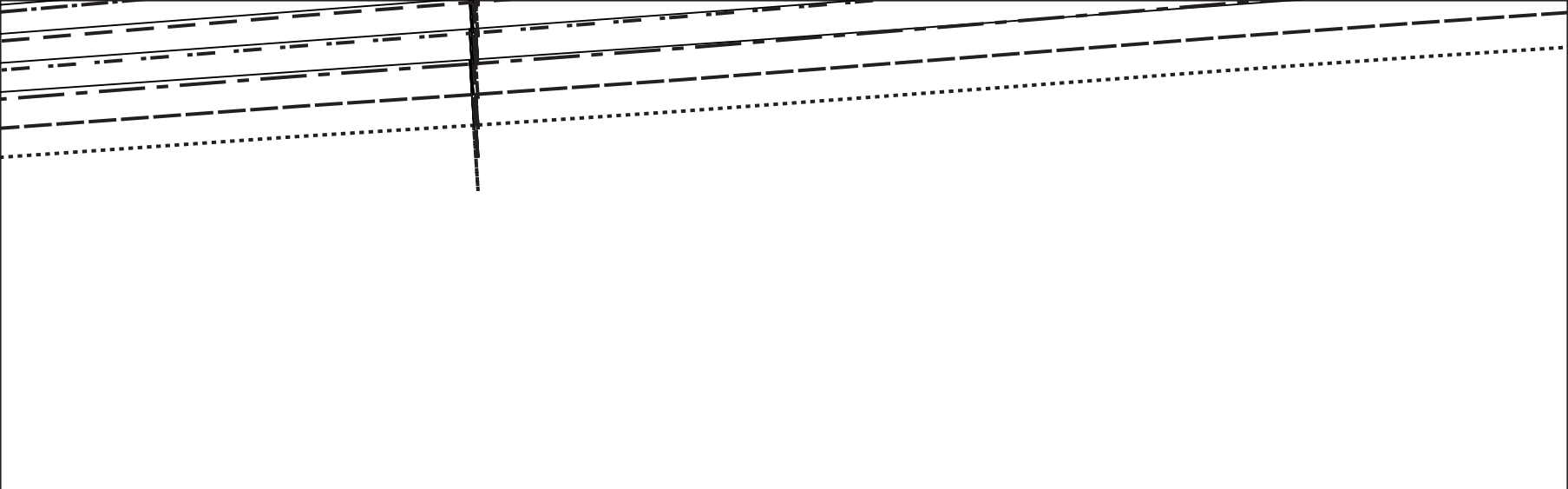

**F**





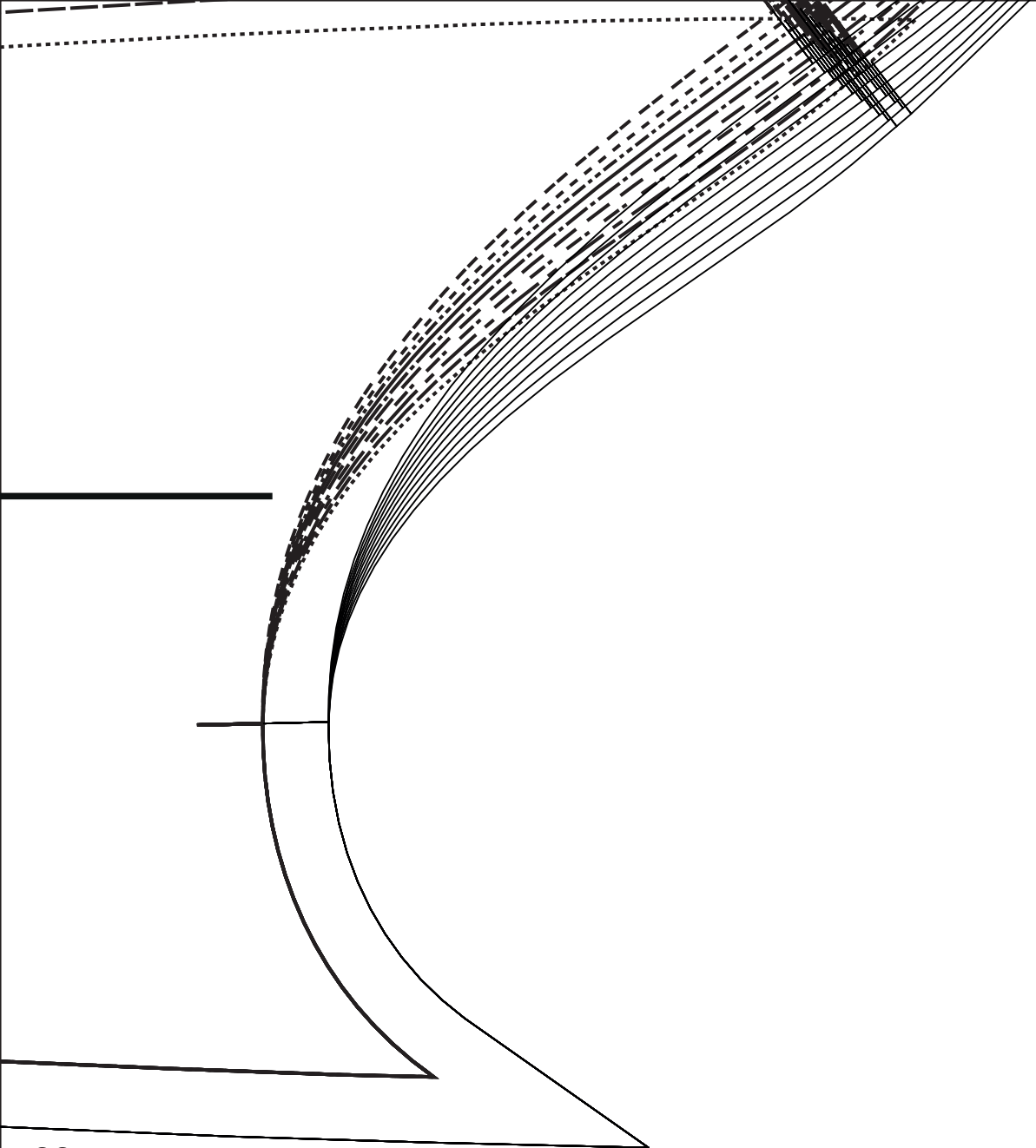

--	--	--	--	--	--	--	--	--	--

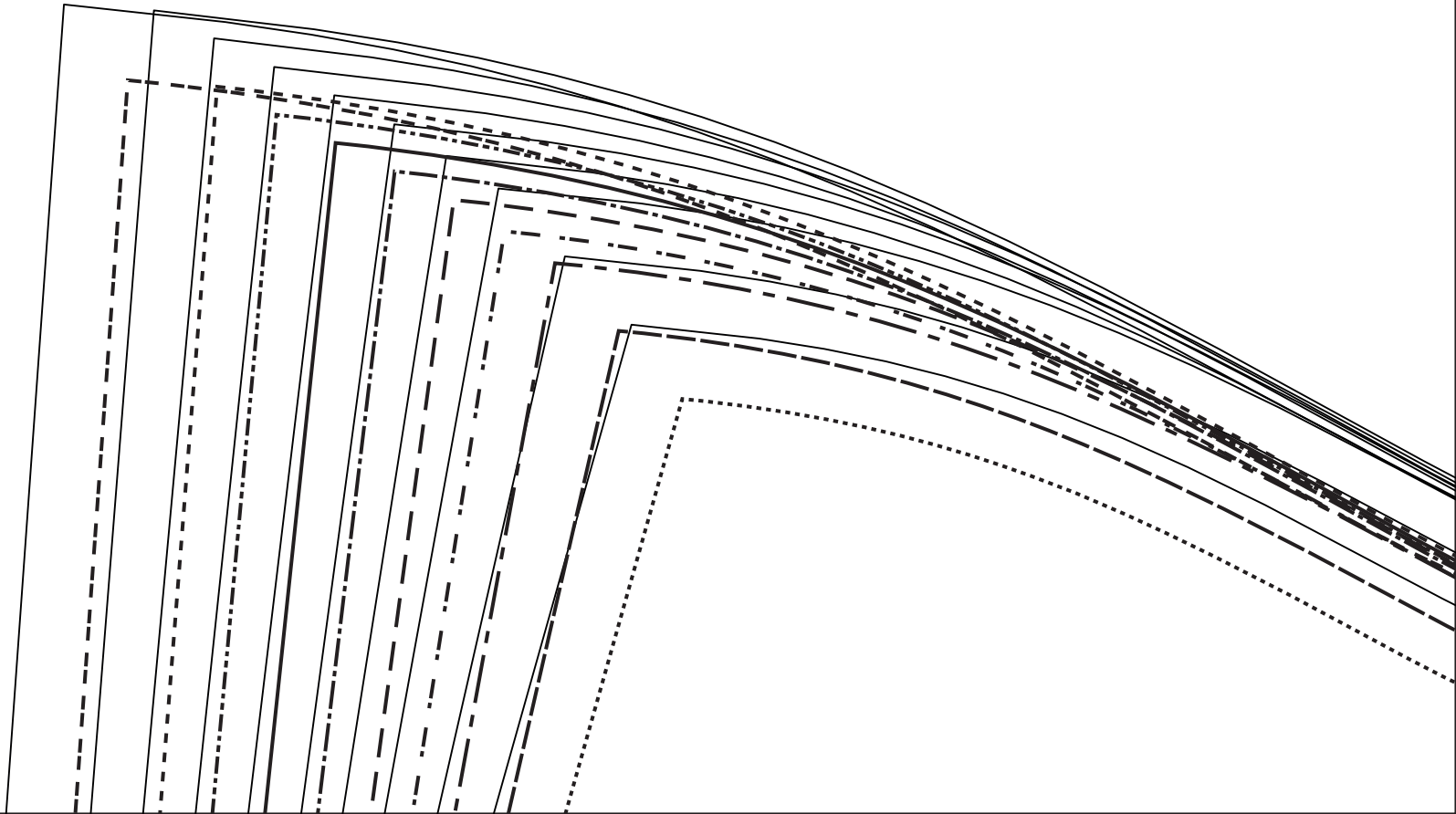

MR/MDS/CB/RM

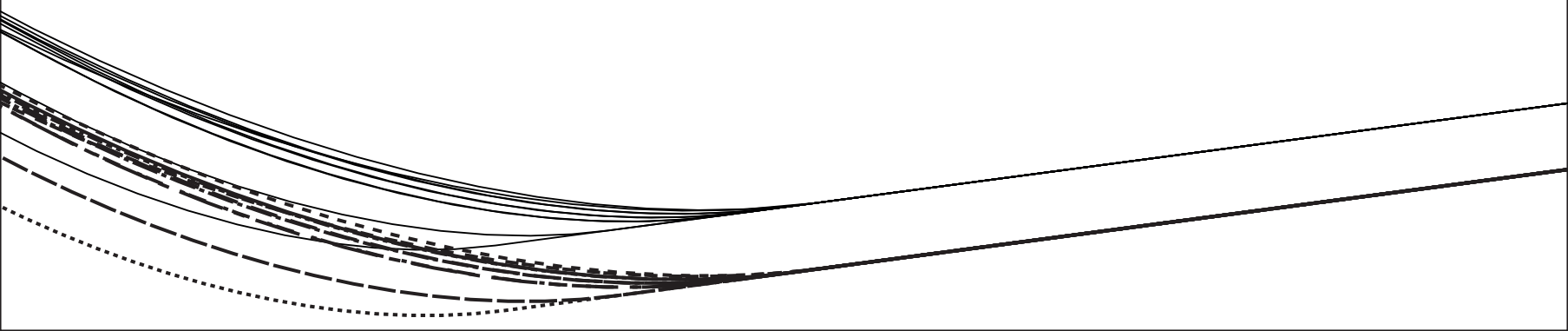

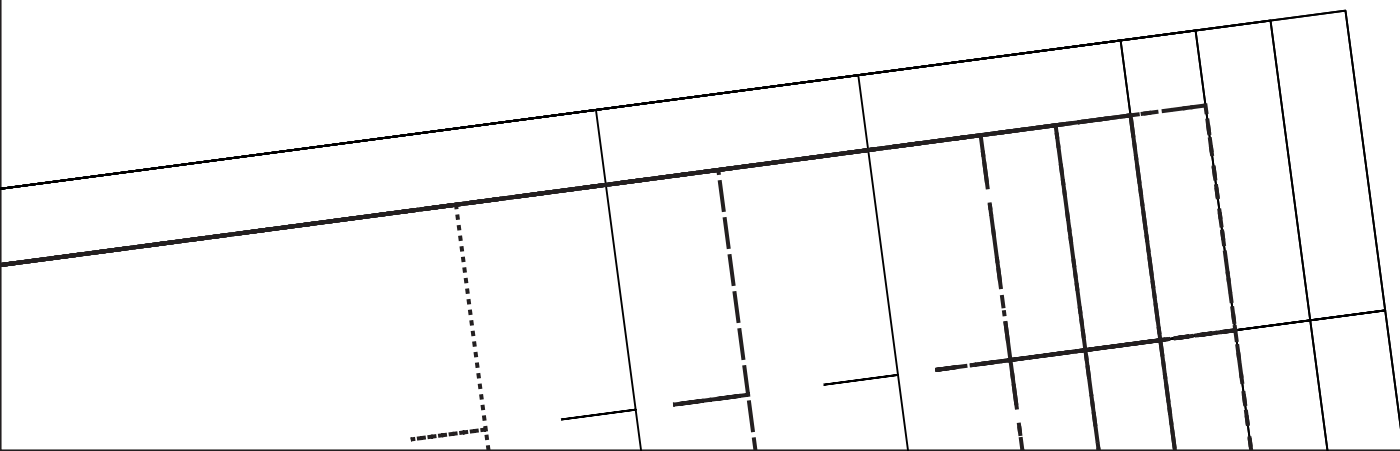
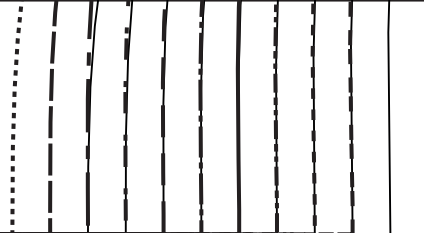







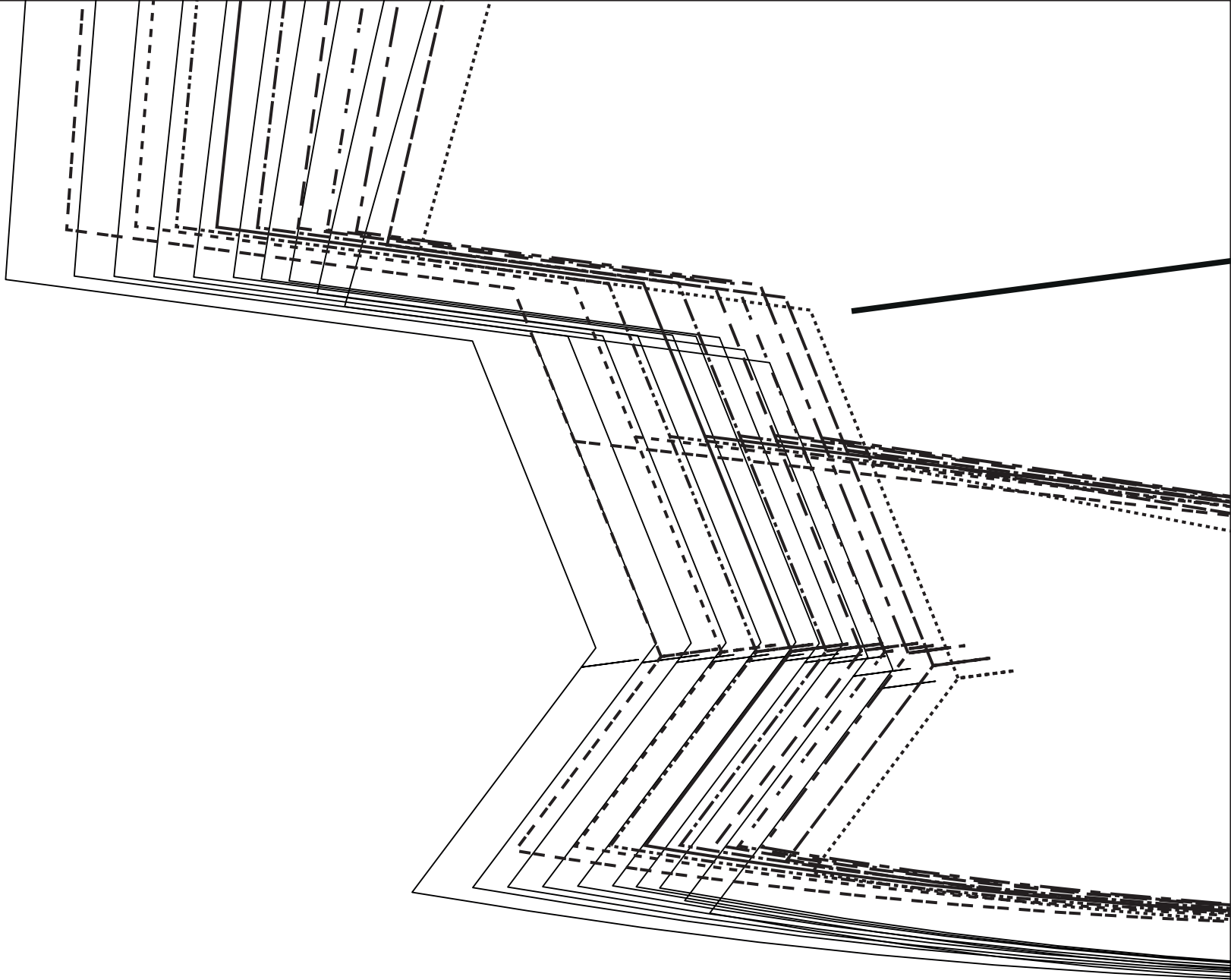



1

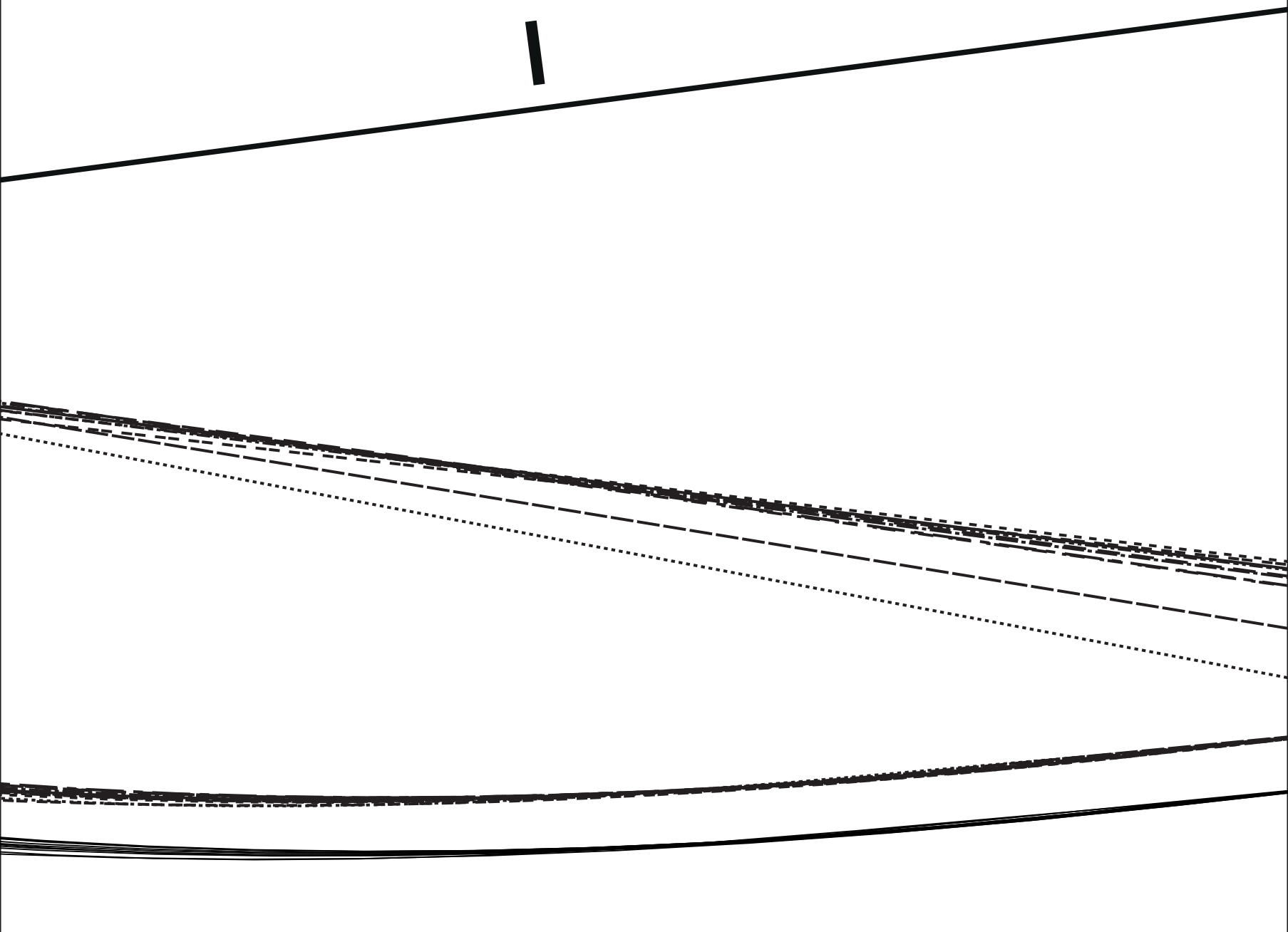

42

