

Pax

Broek / Pantalon / Trousers / Hose

Maten / Tailles / Sizes / Größen:

---	34
---	36
---	38
---	40
---	42
---	44
---	46
---	48
---	50
---	52
---	54
---	56

Patroondelen / Pièces du patron / Pattern pieces / Schnittteile:

- A** voorpand / devant / front panel / Vorderteil
- B** rugpand / dos / back panel / Rückenteil
- C** zak / poche / pocket / Tasche
- D** tailleband RVP / ceinture DVD / waistband RFP / Bund RVT
- E** tailleband LVP / ceinture DVG / waistband LFP / Bund LVT
- F** tailleband RP/ ceinture DS / waistband BP / Bund RT
- G** bies / liseré / trim / Paspel
- H** inkijk / ouverture poche / outer pocket / Tascheneingriff
- I** gulpstuk / braguette / fly / Eingriff

Patroonschema / Schéma du Patron / Pattern Diagram / Übersichtsplan zum Zusammenkleben

1	2	3	4	5	6	7
8	9	10	11	12	13	14
15	16	17	18	19	20	21
22	23	24	25	26	27	28
29	30	31	32	33	34	35

Controlevierkant / Carré de controle / Test square / Kontrollquadrat

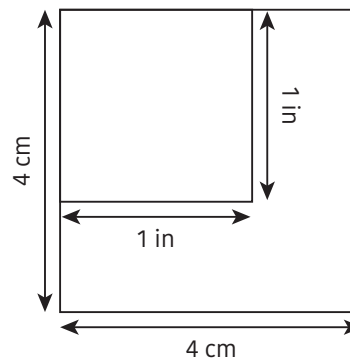

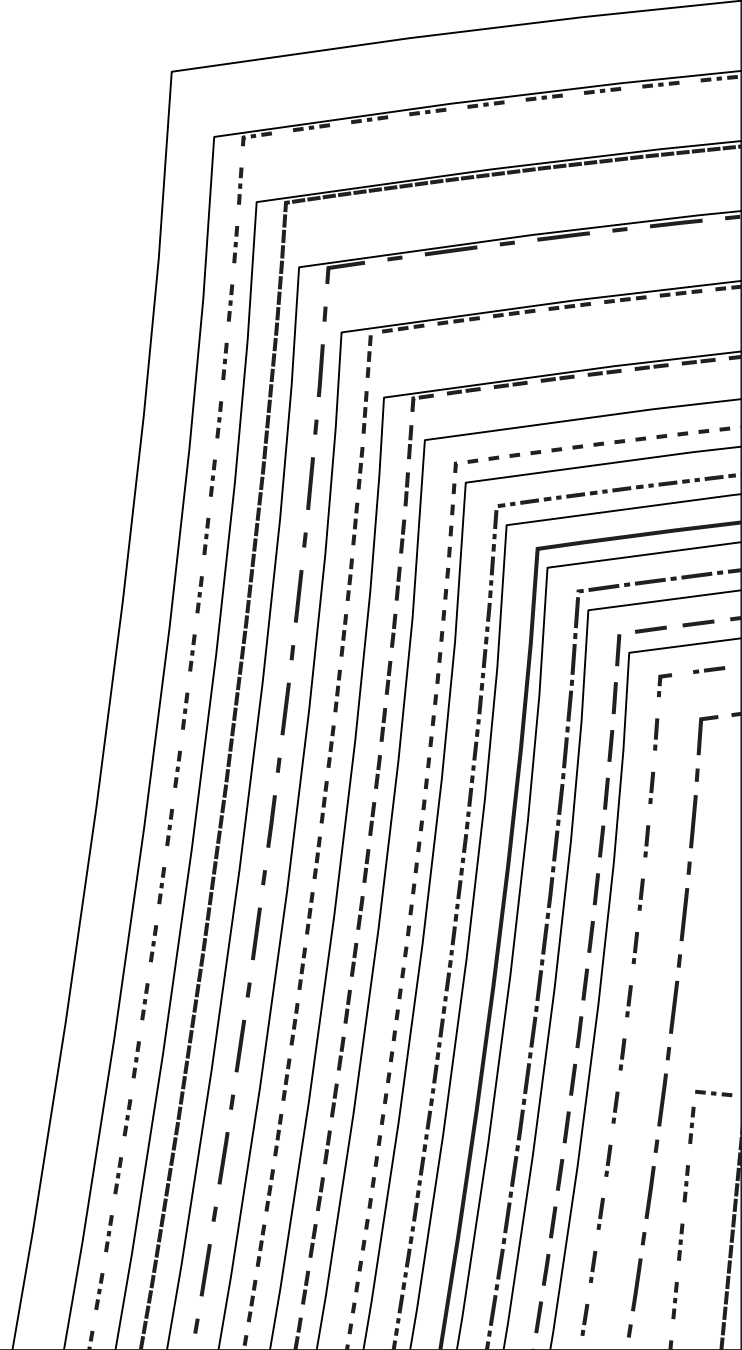
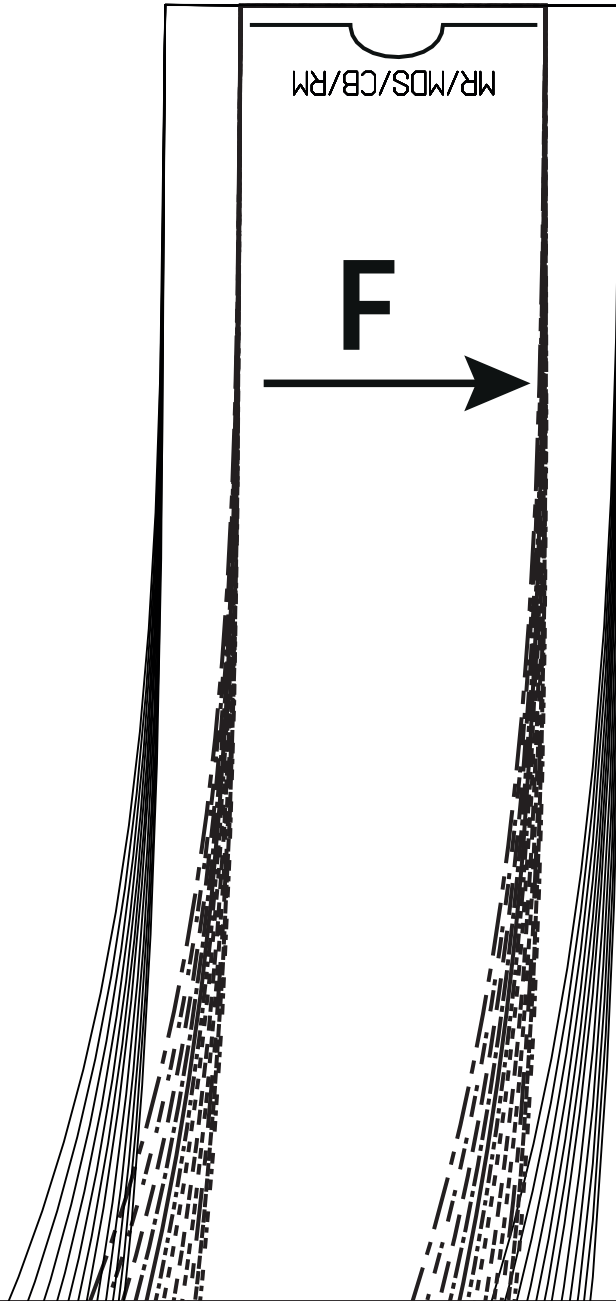

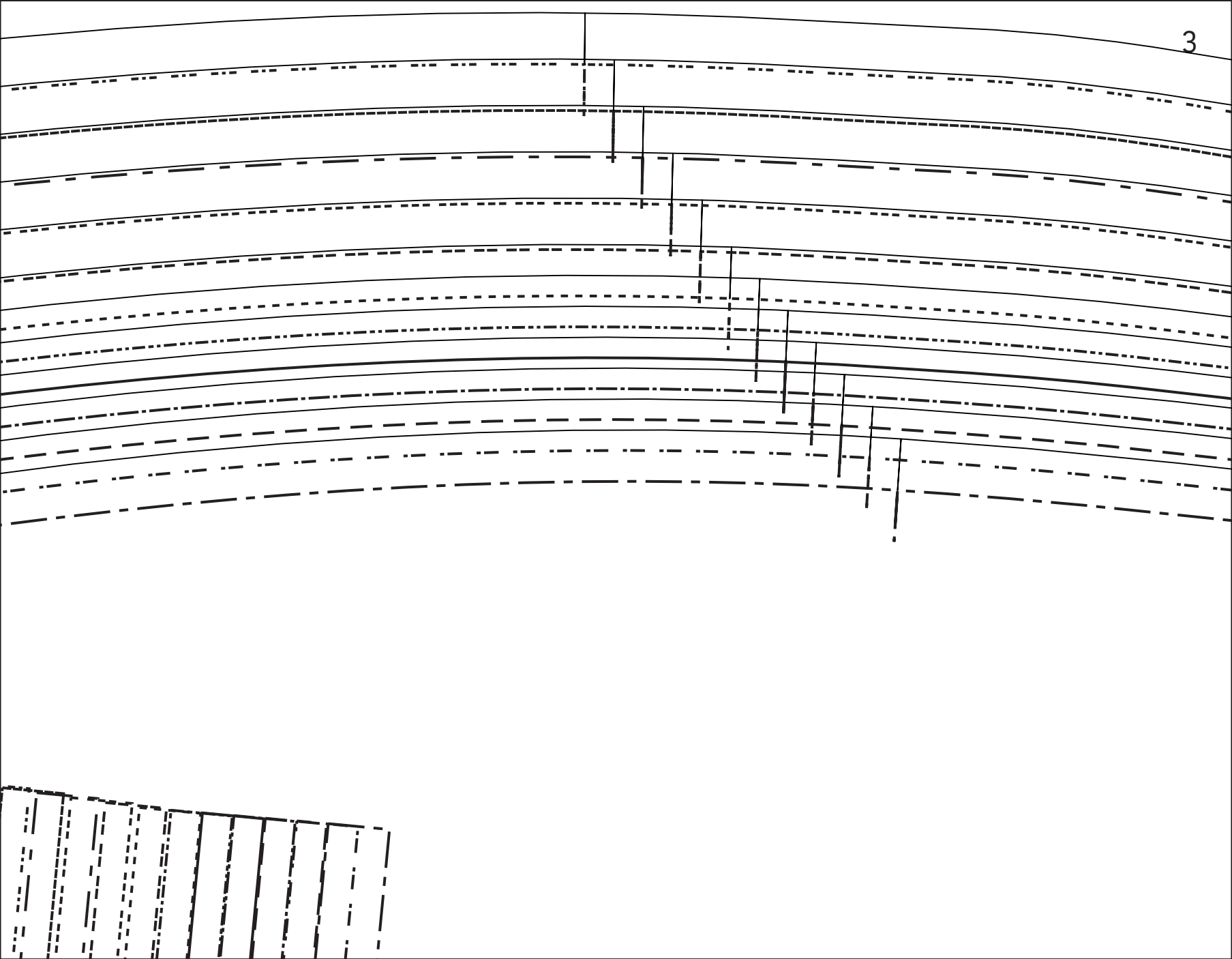

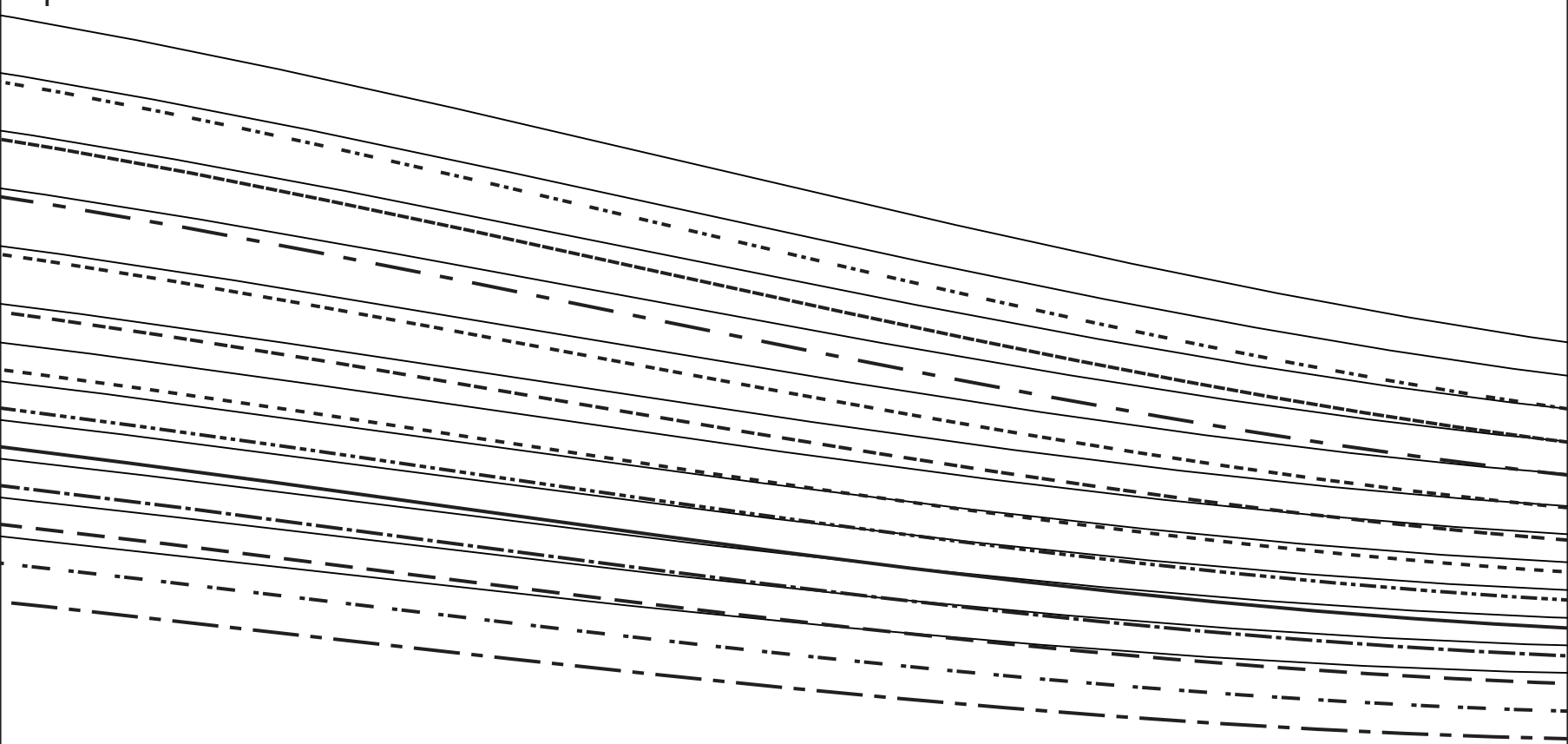

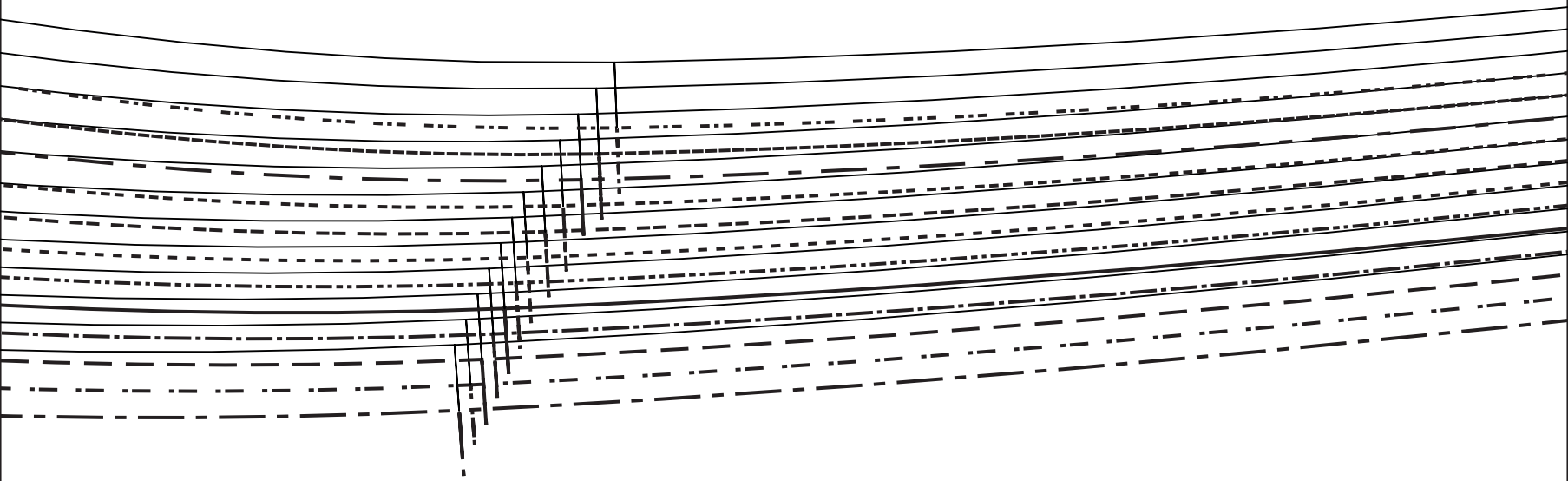

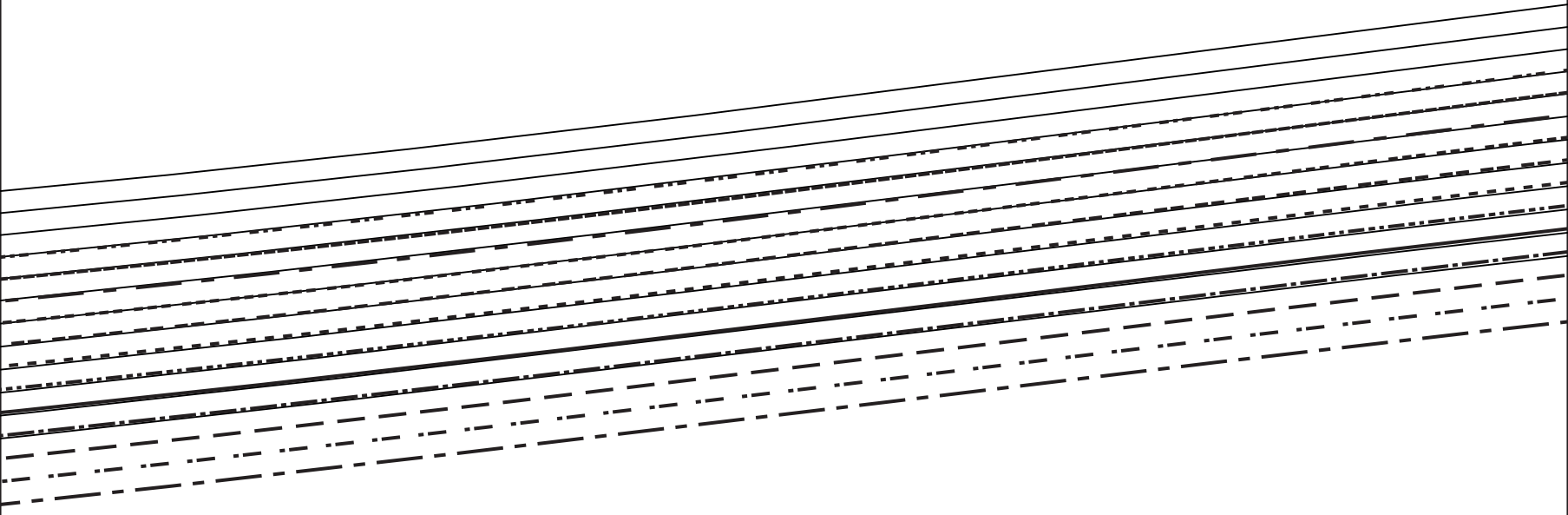

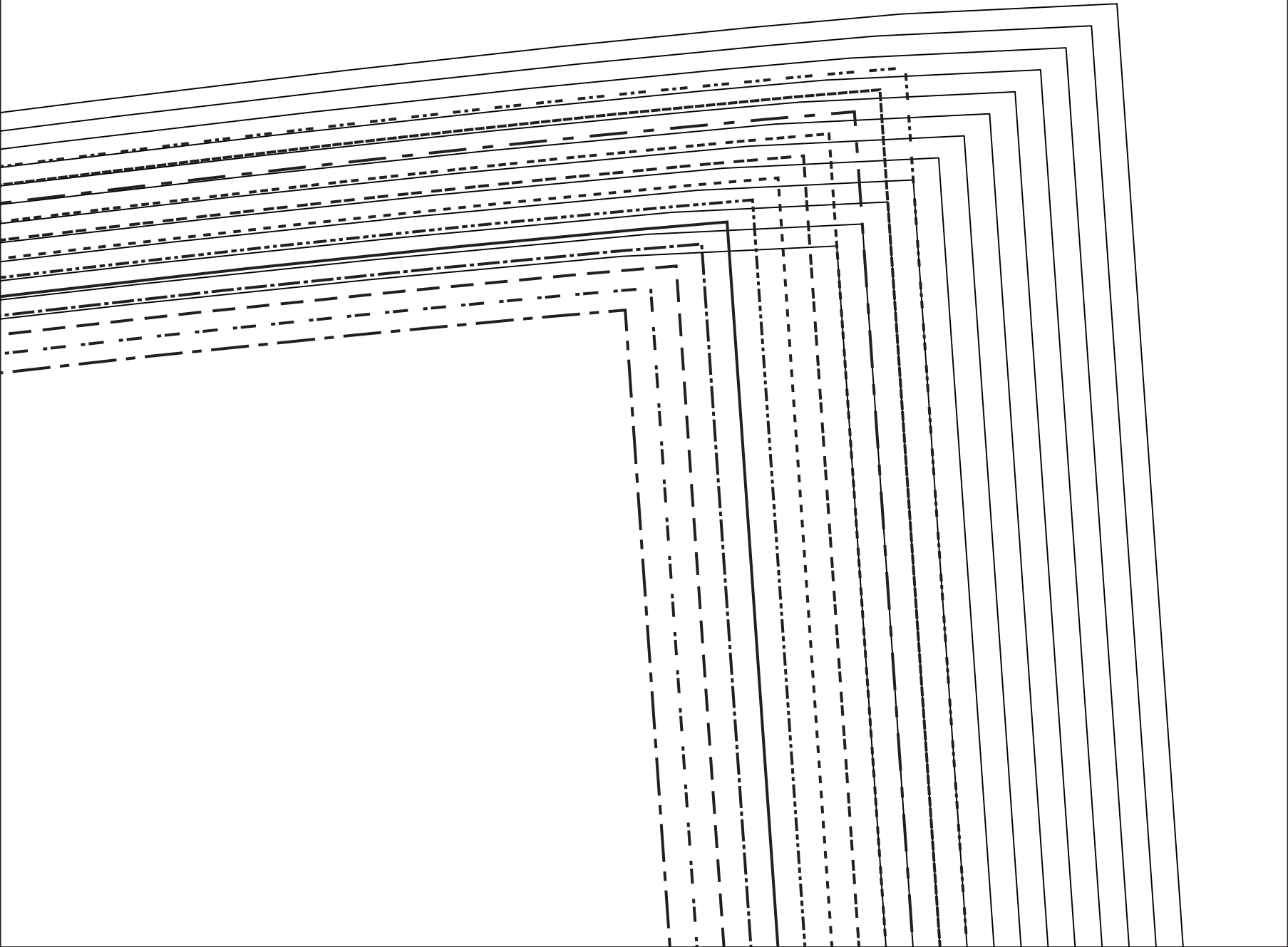

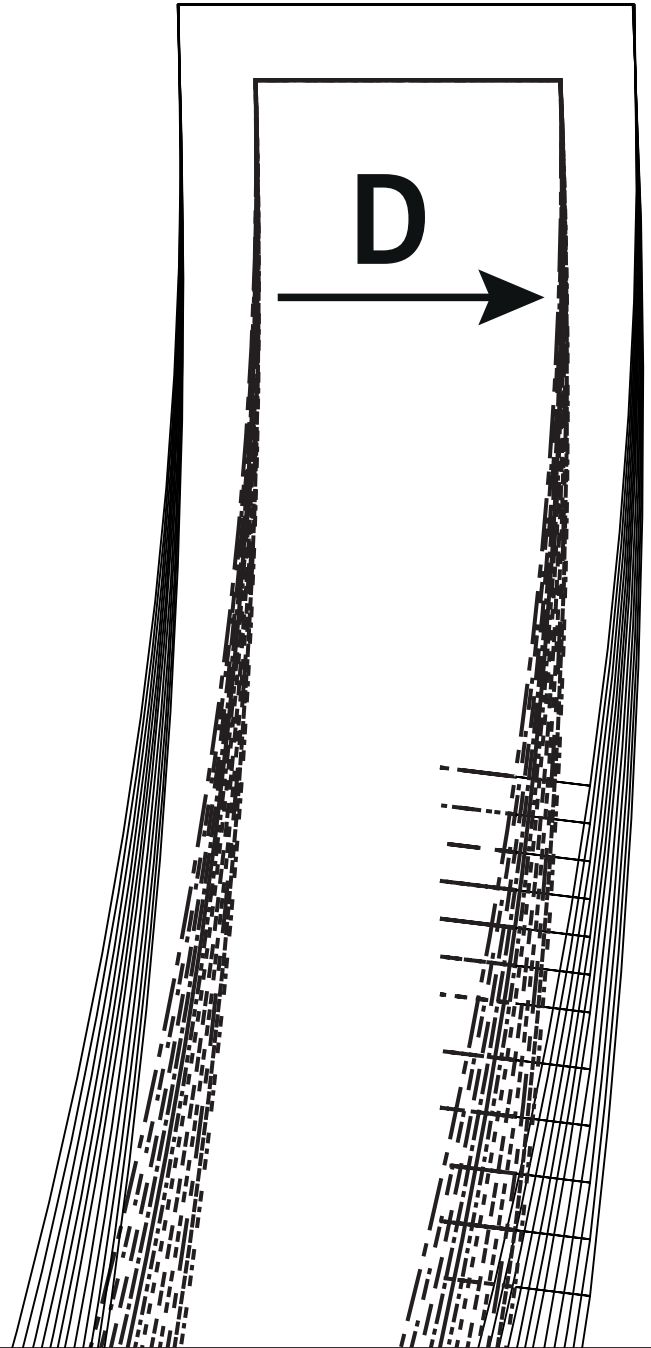
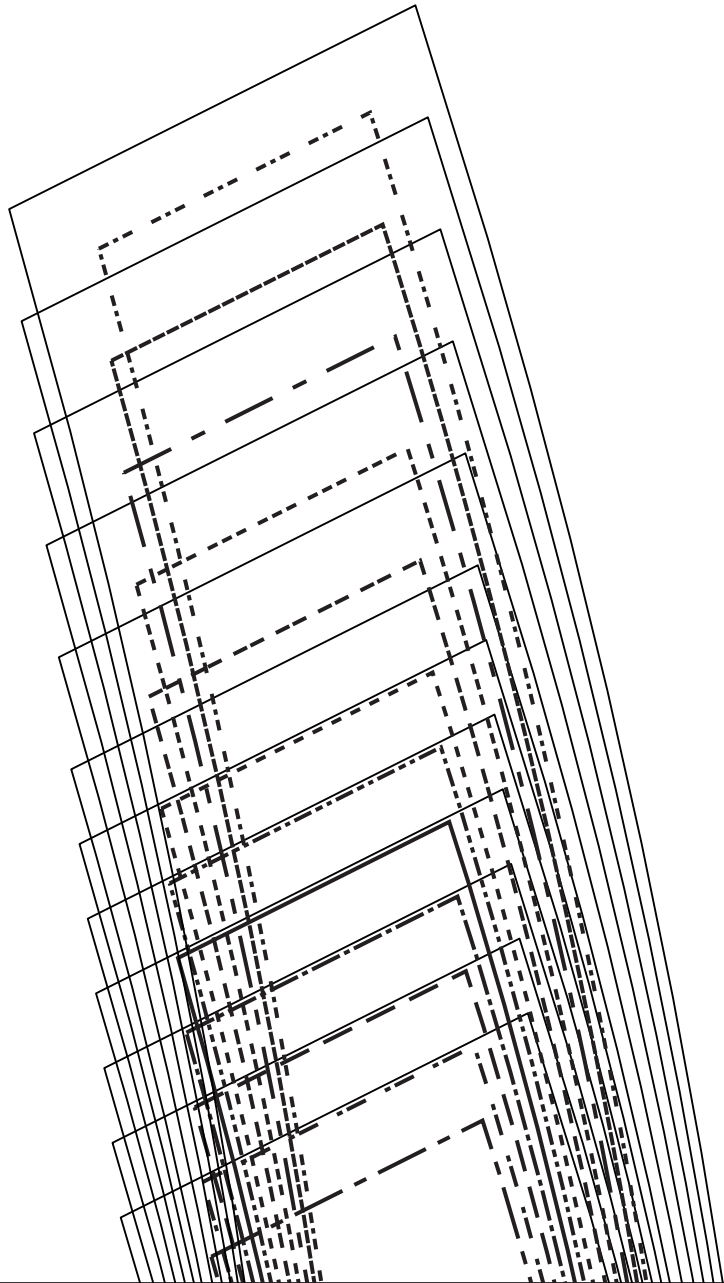

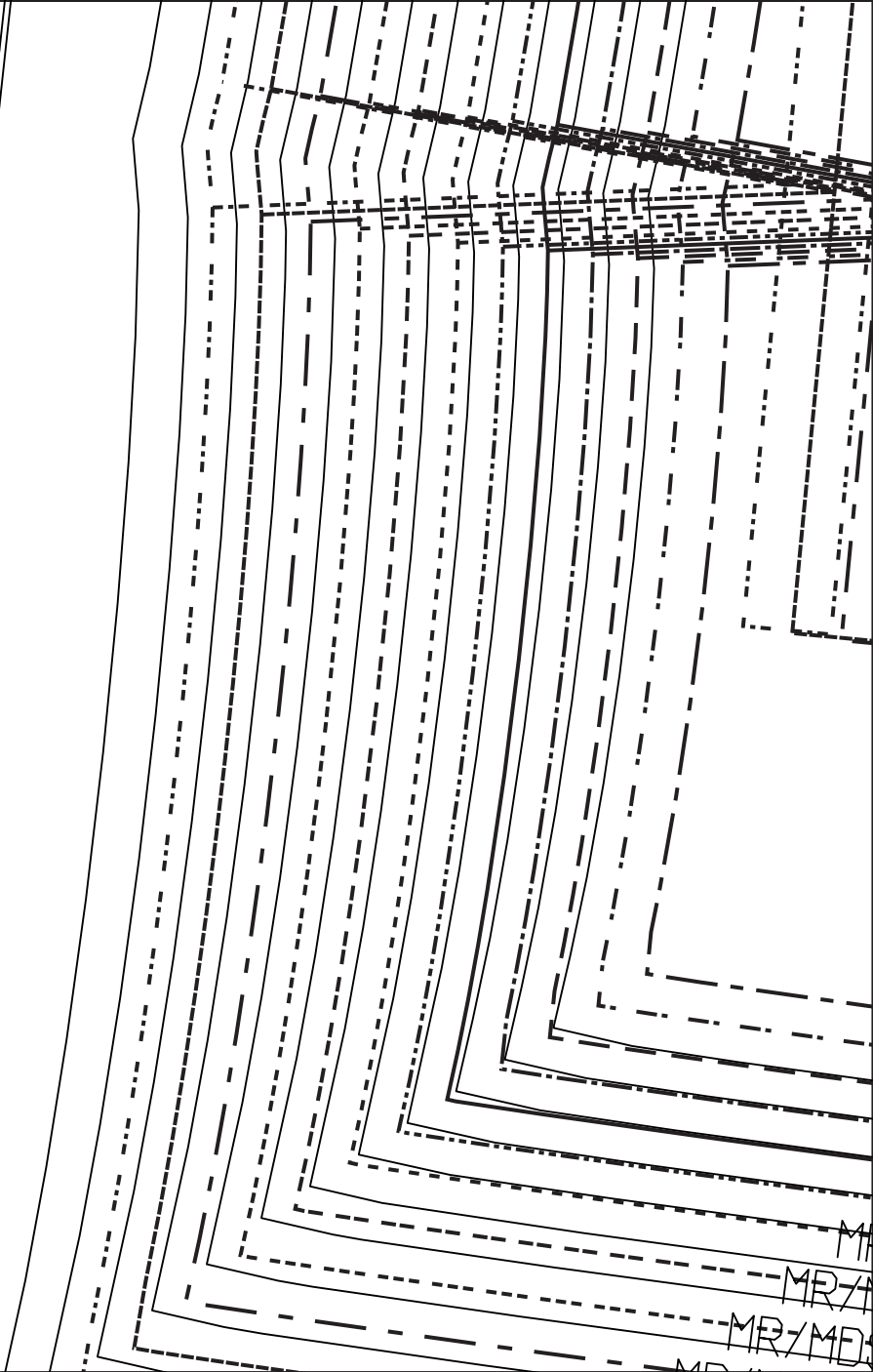
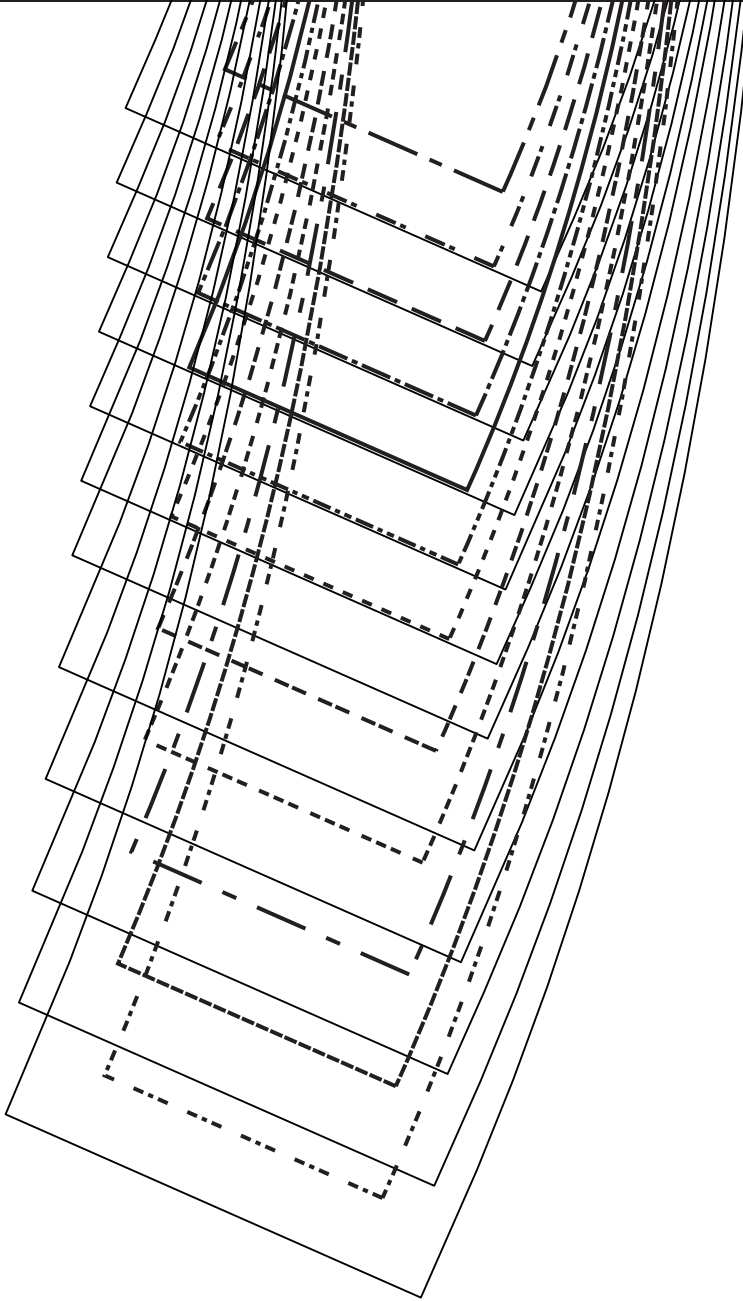

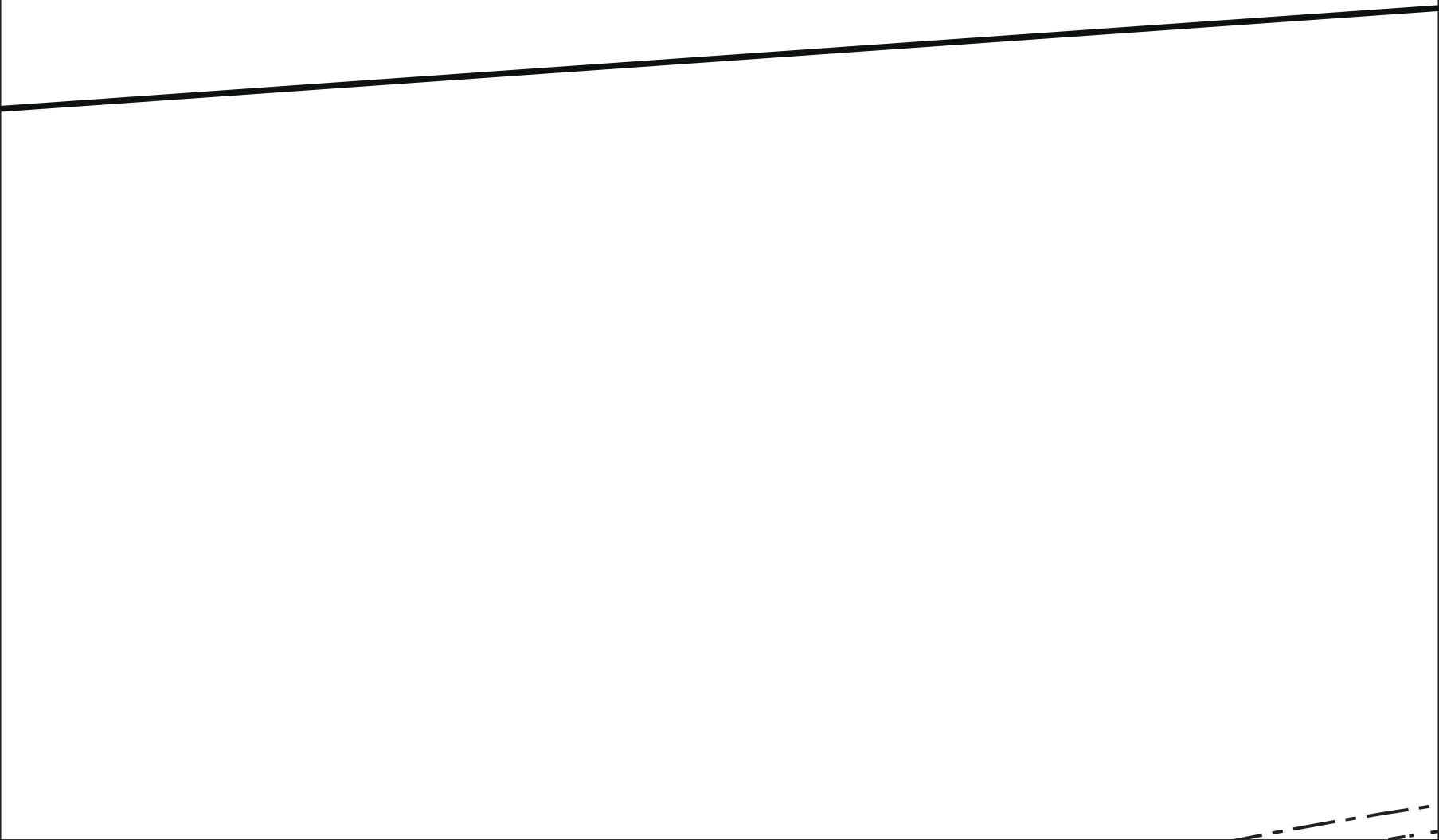

B

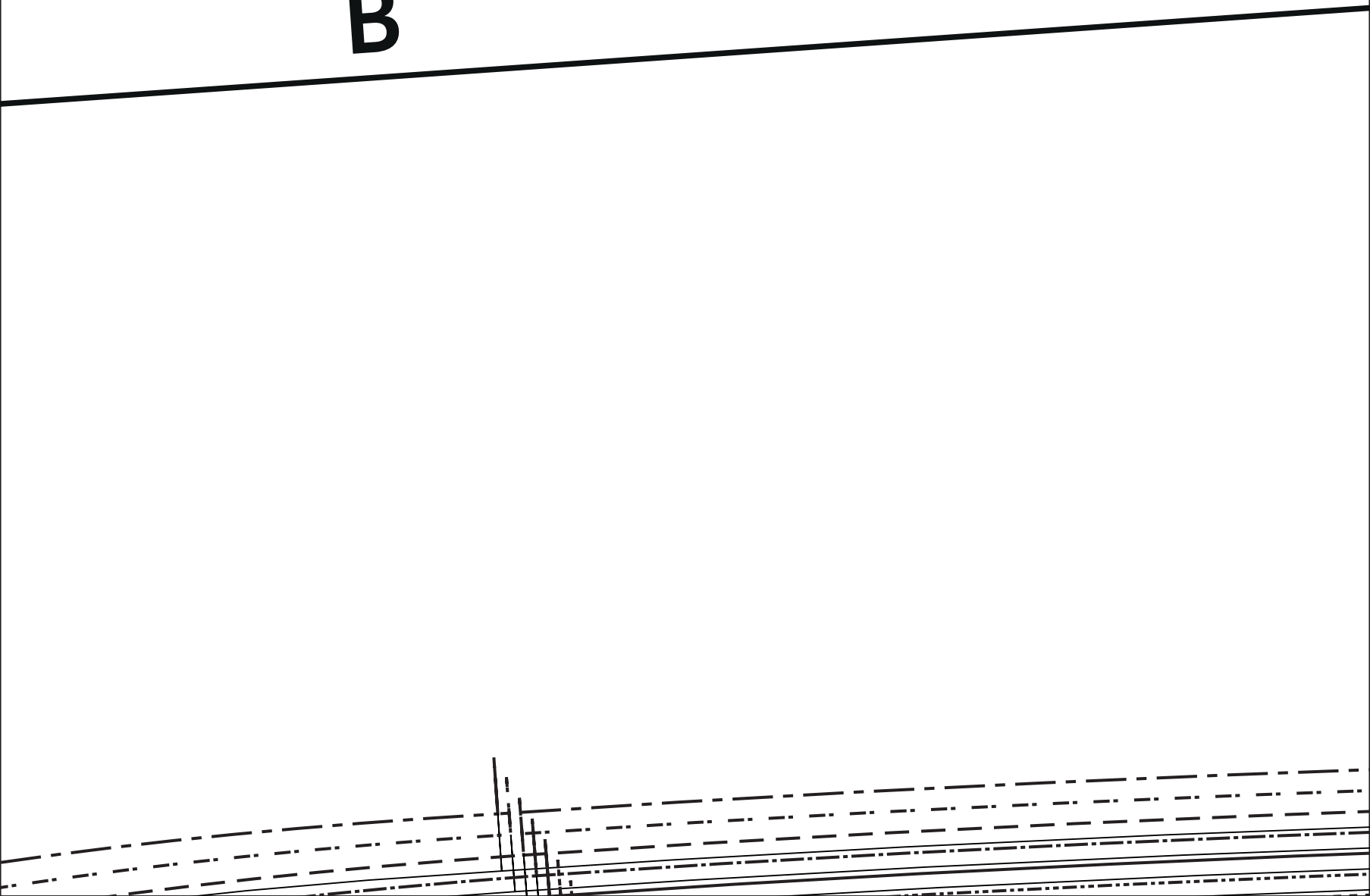

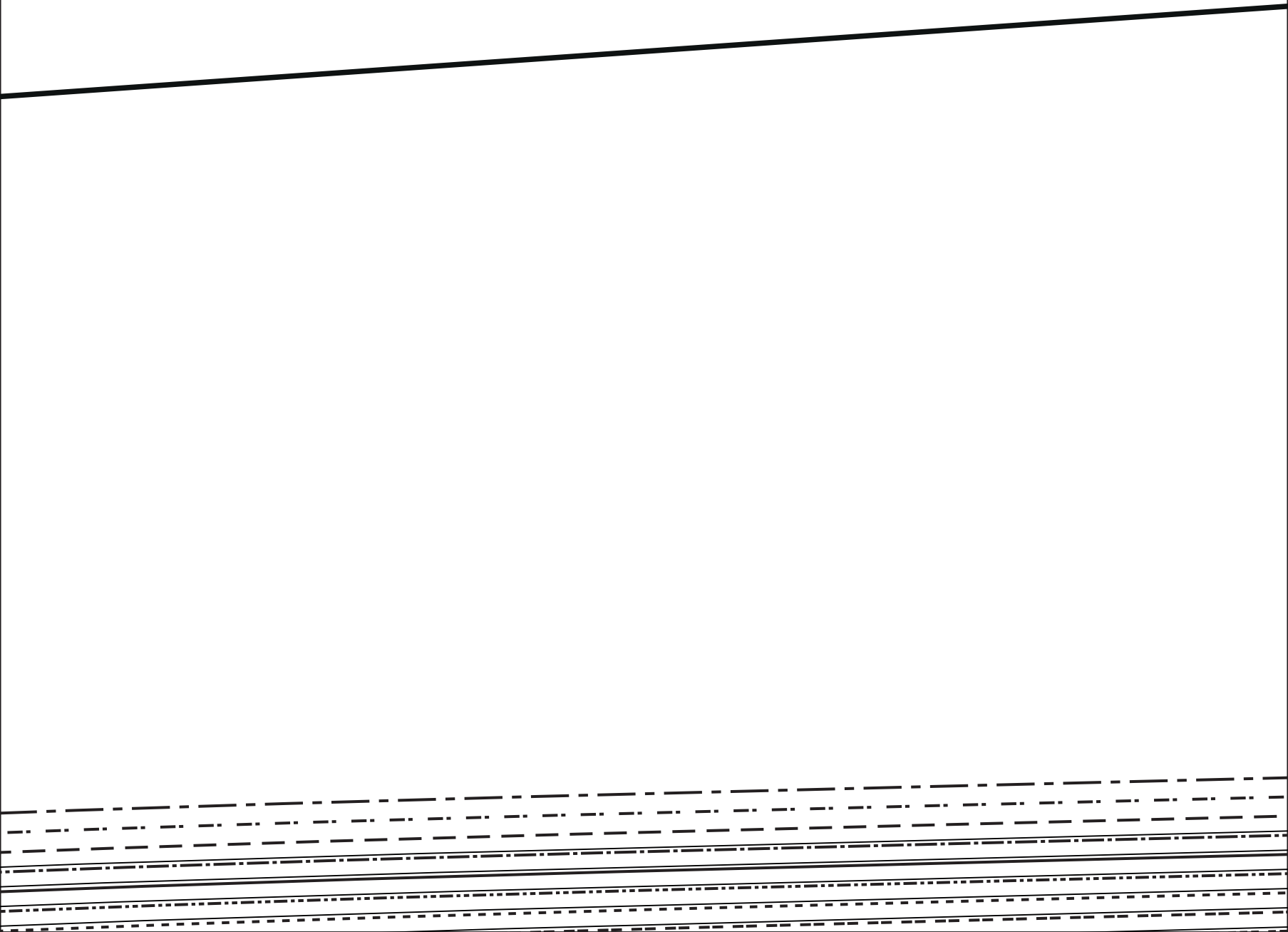

14

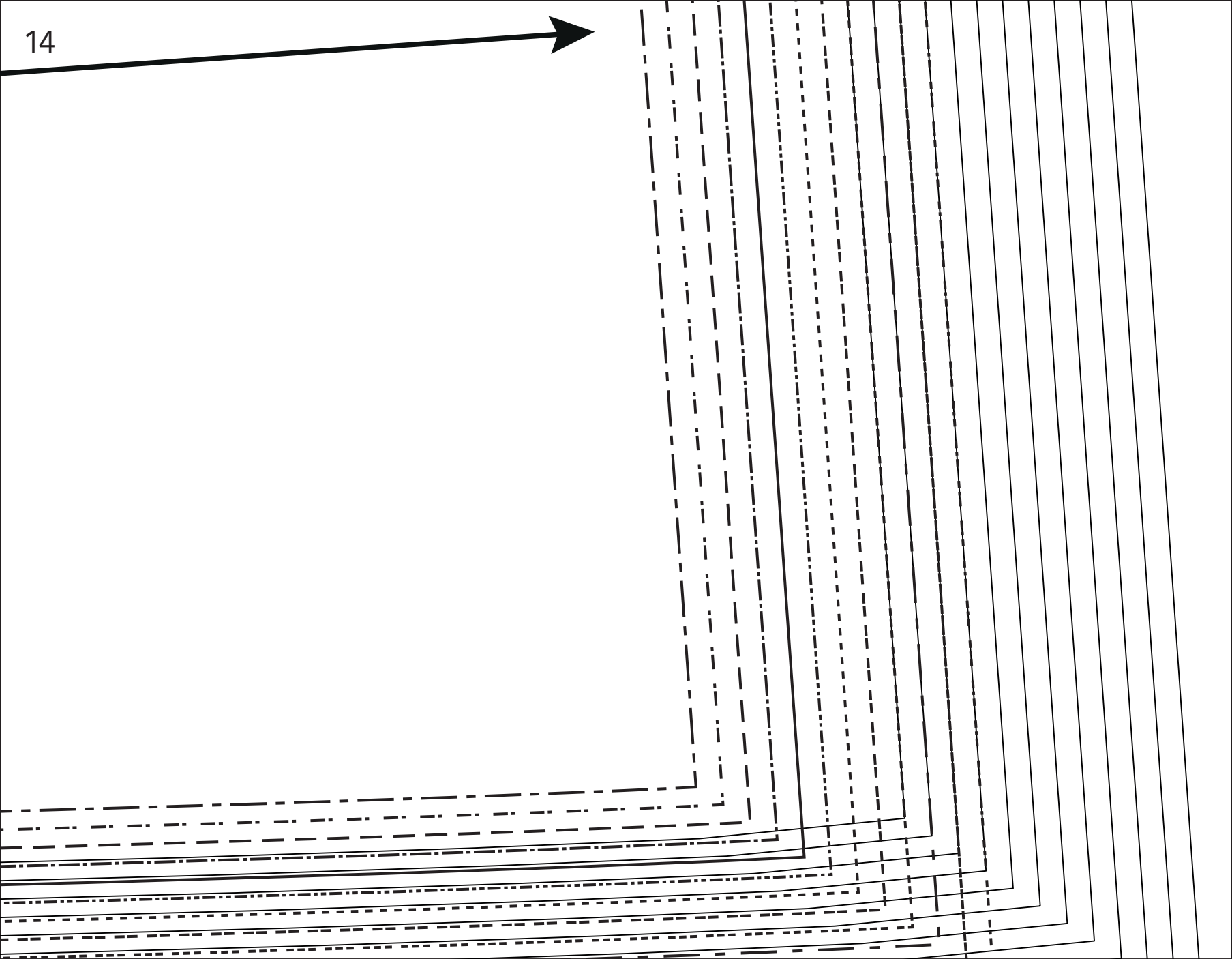

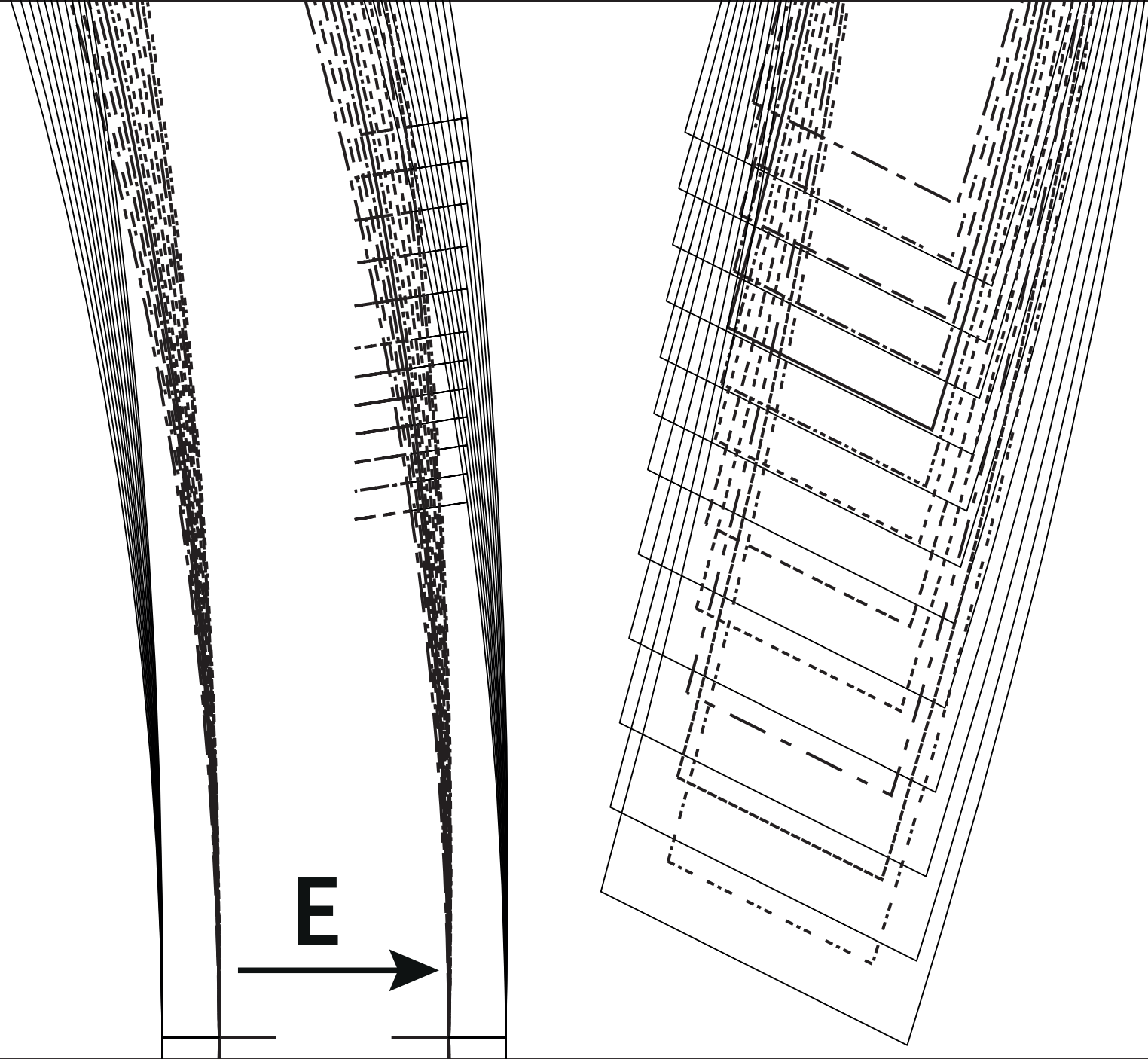

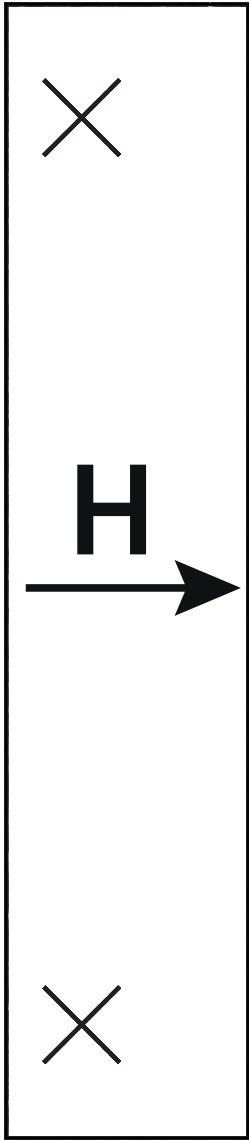

MR/MDS/1
MR/MDS/CB

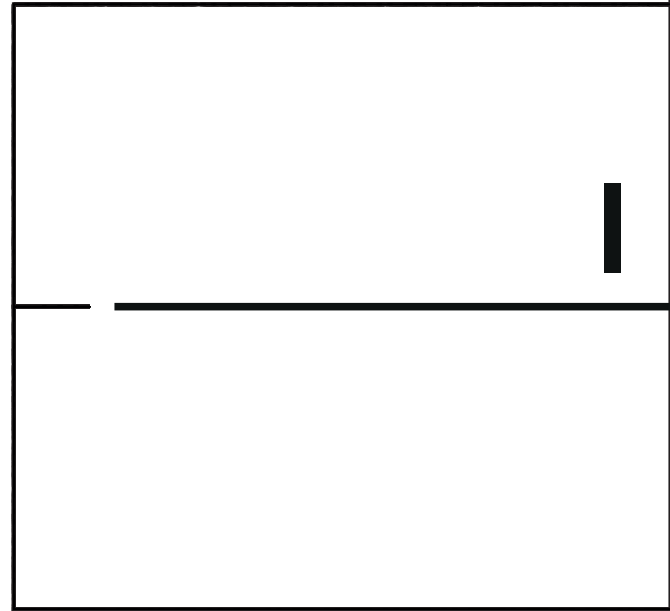

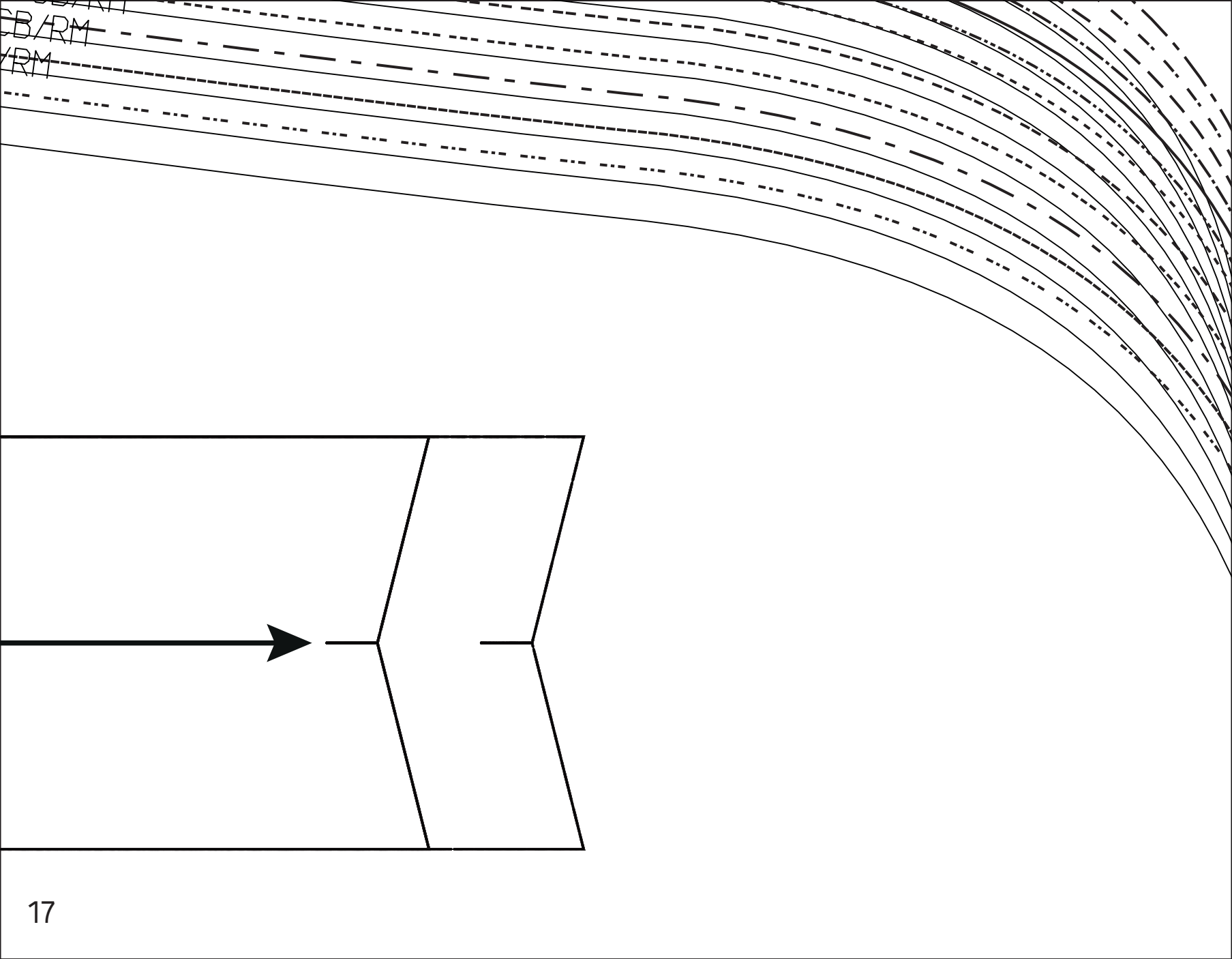

BB/RT
BB/RM
Y/RM

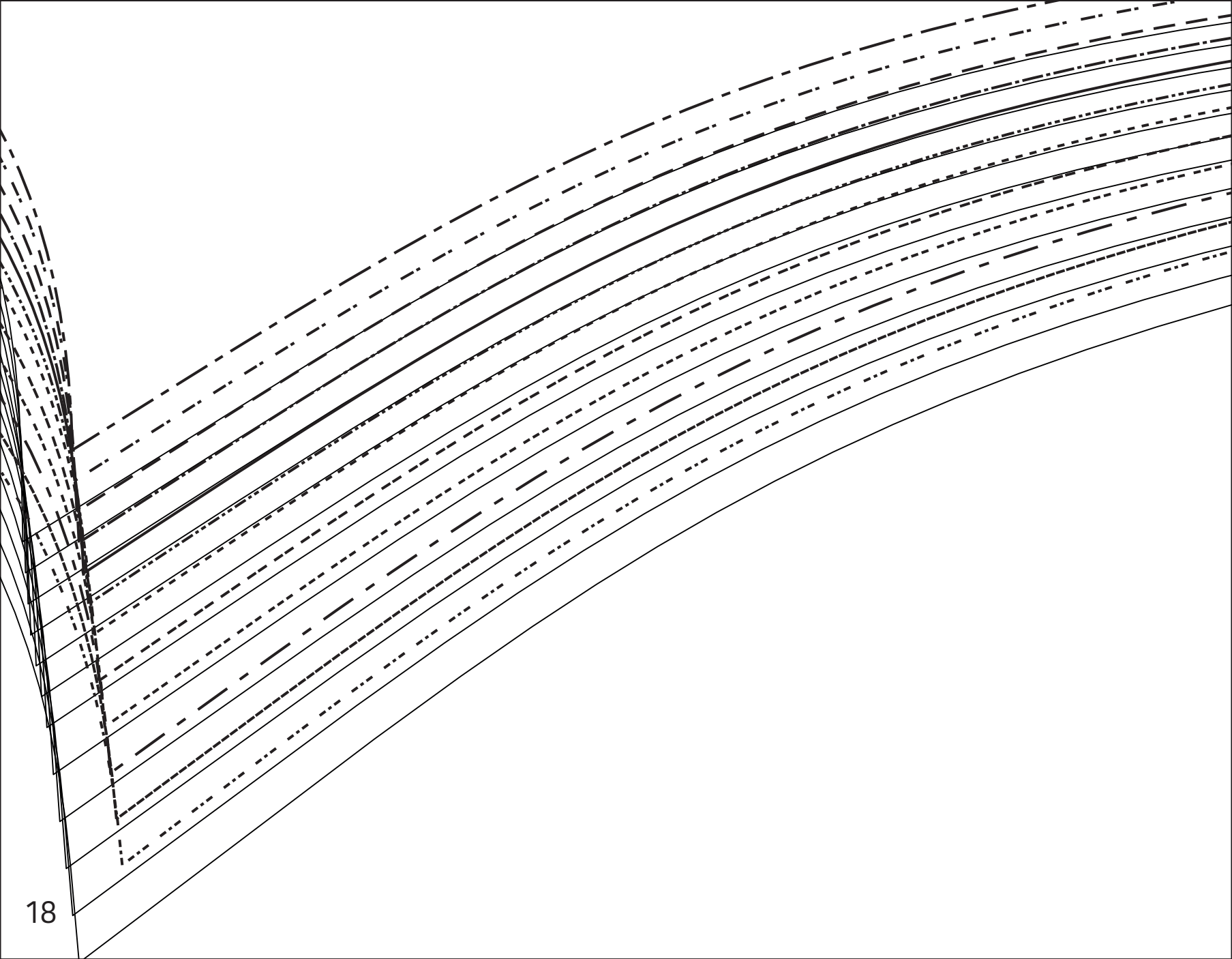

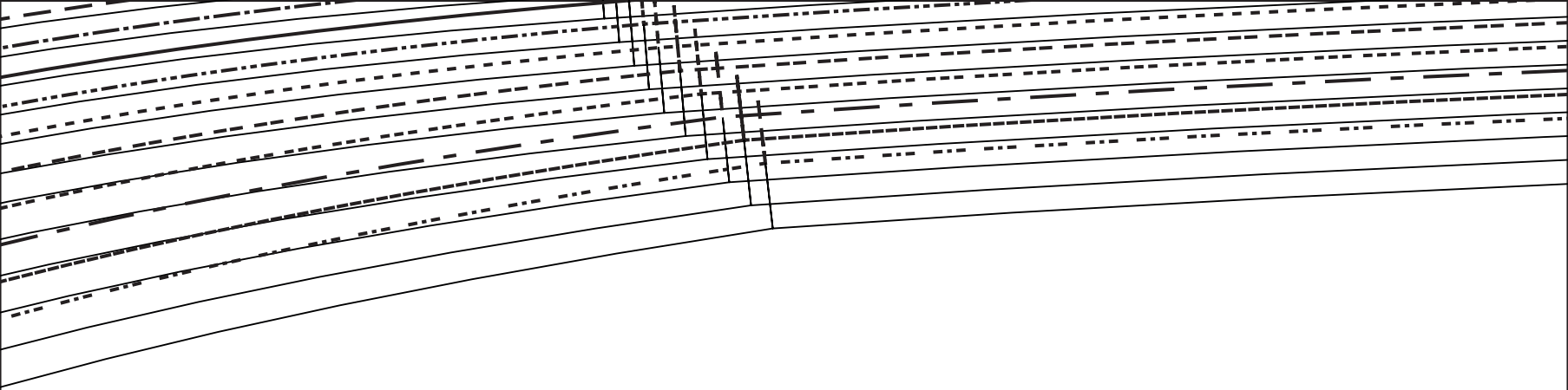

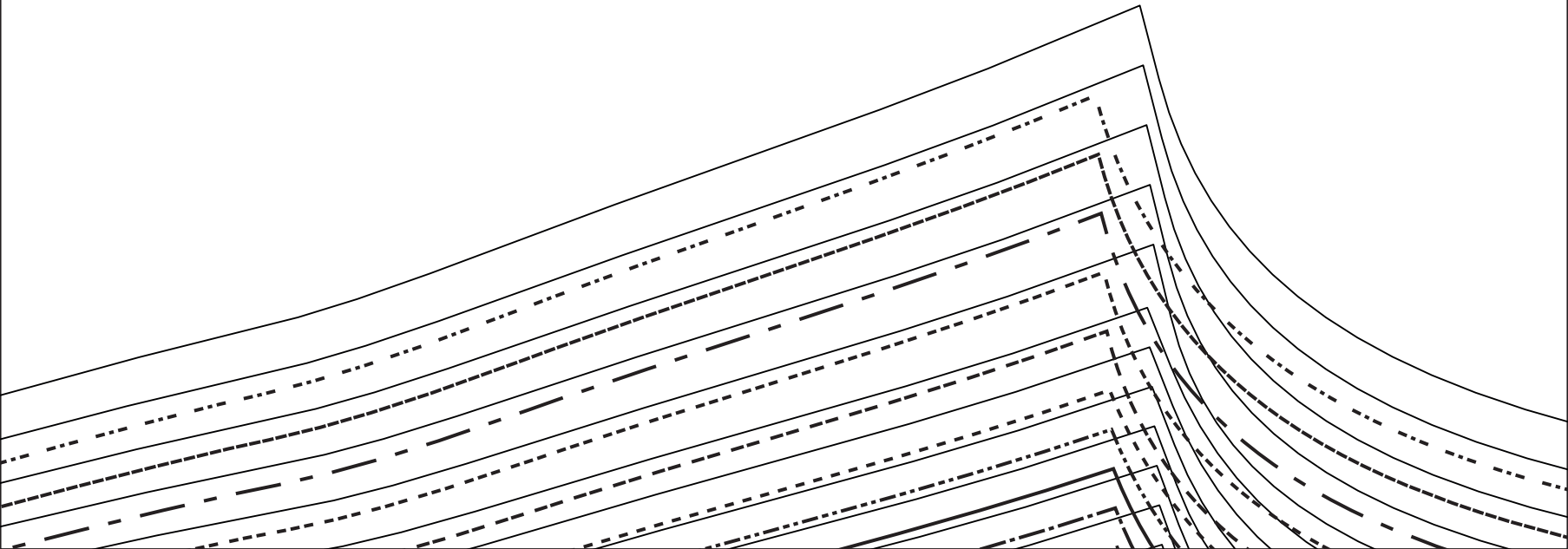

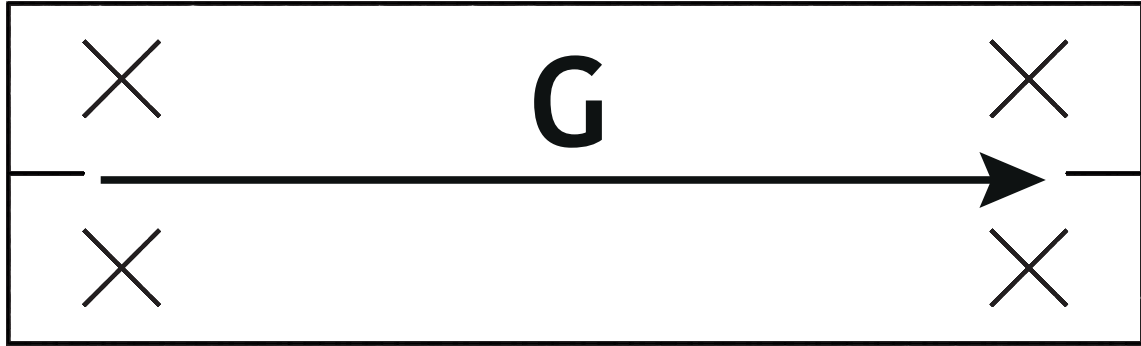

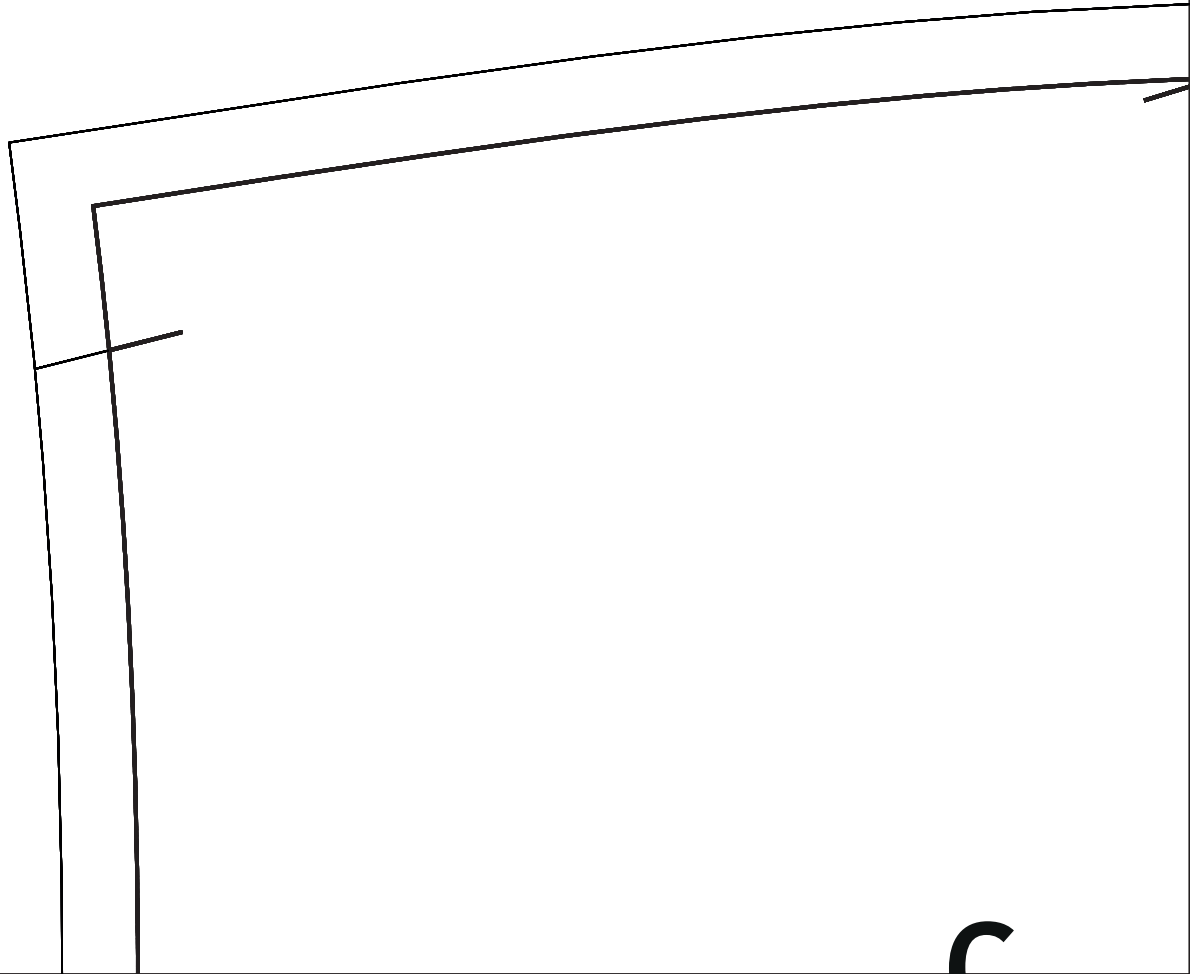

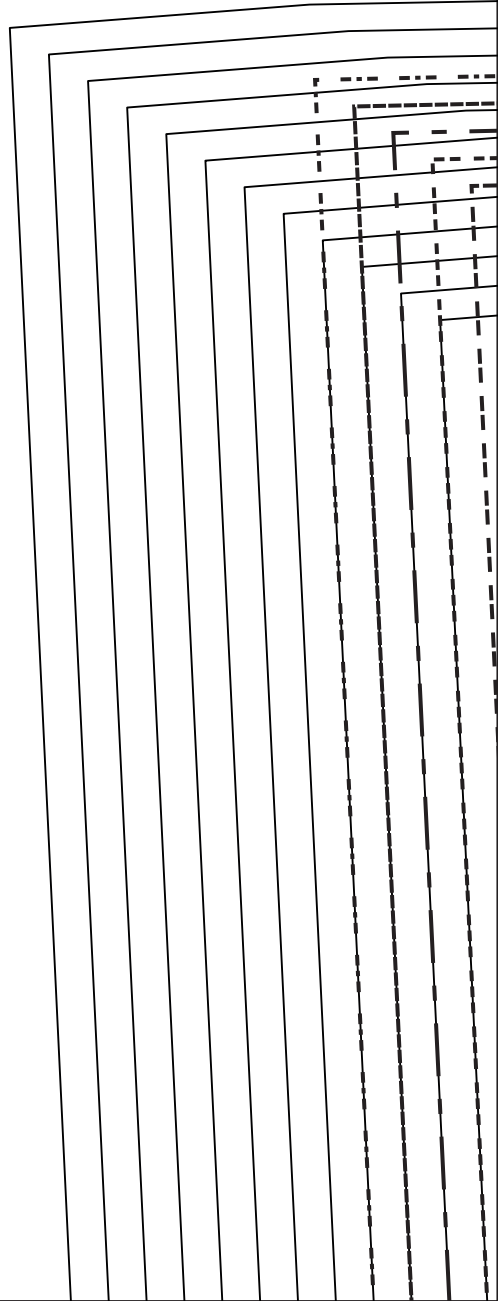
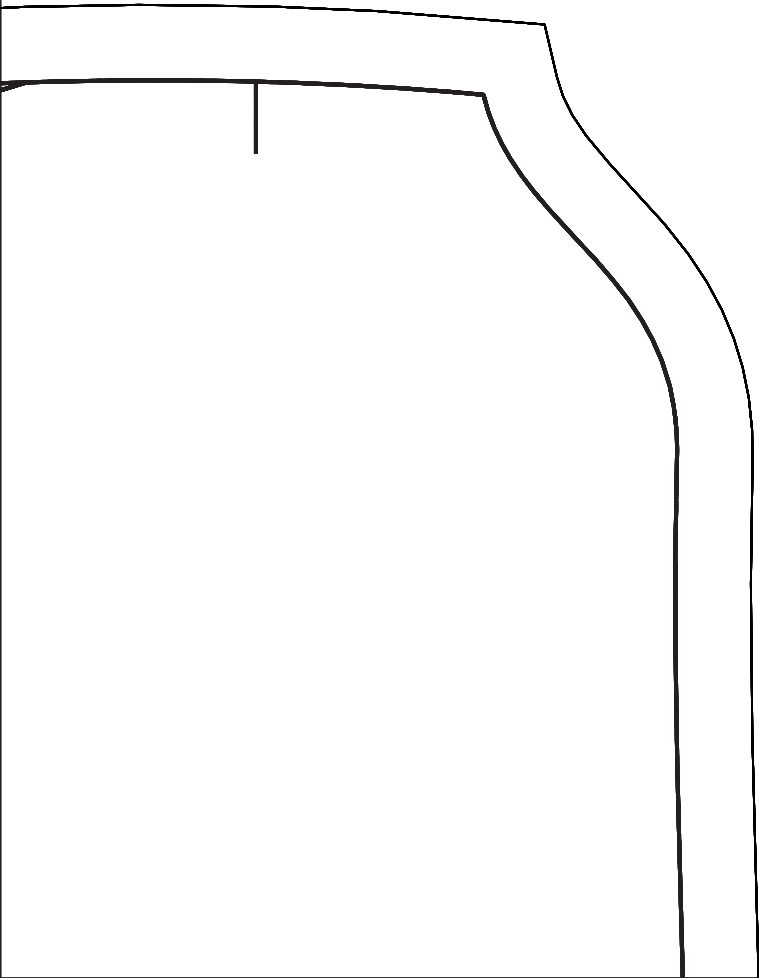

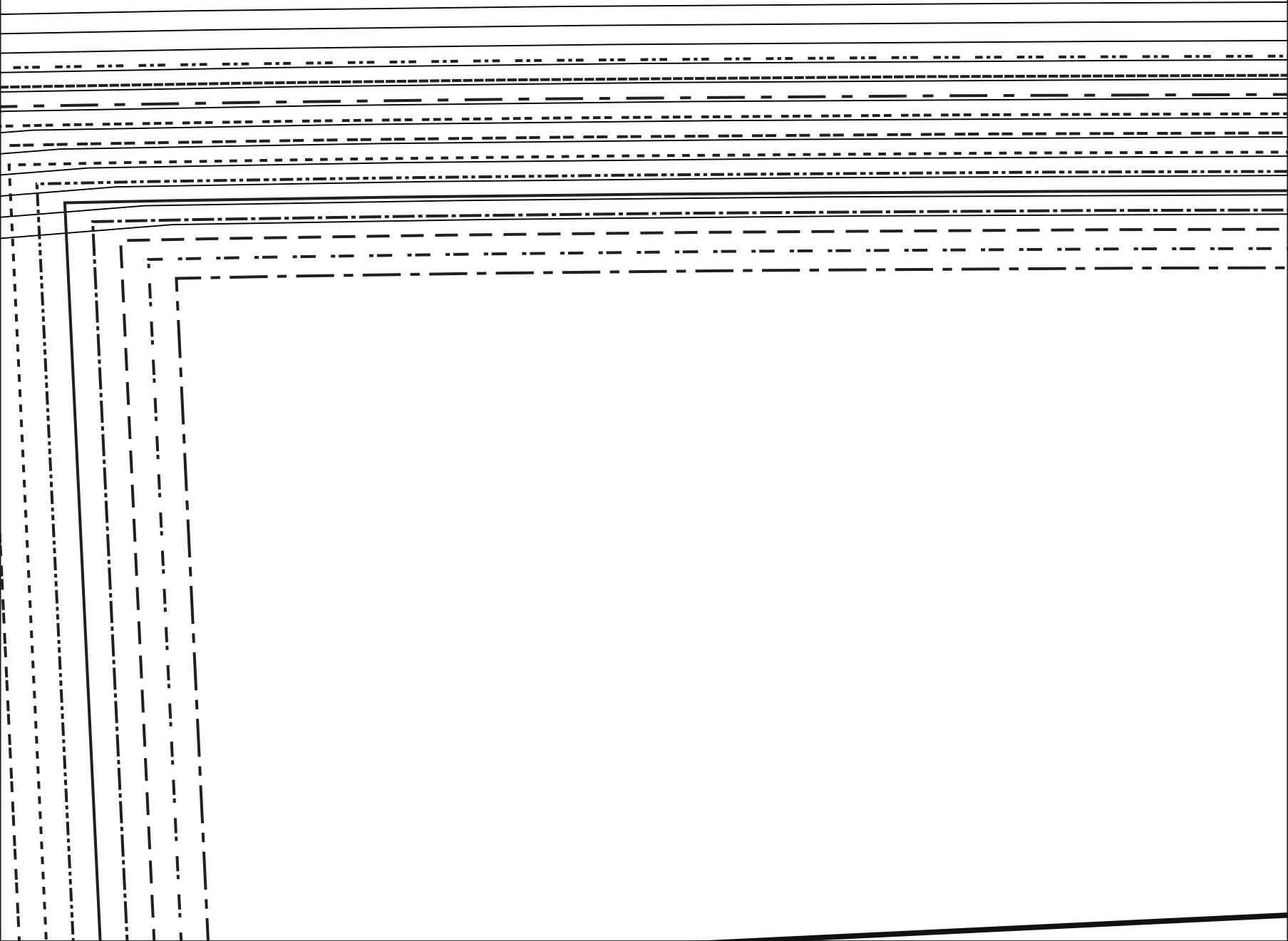

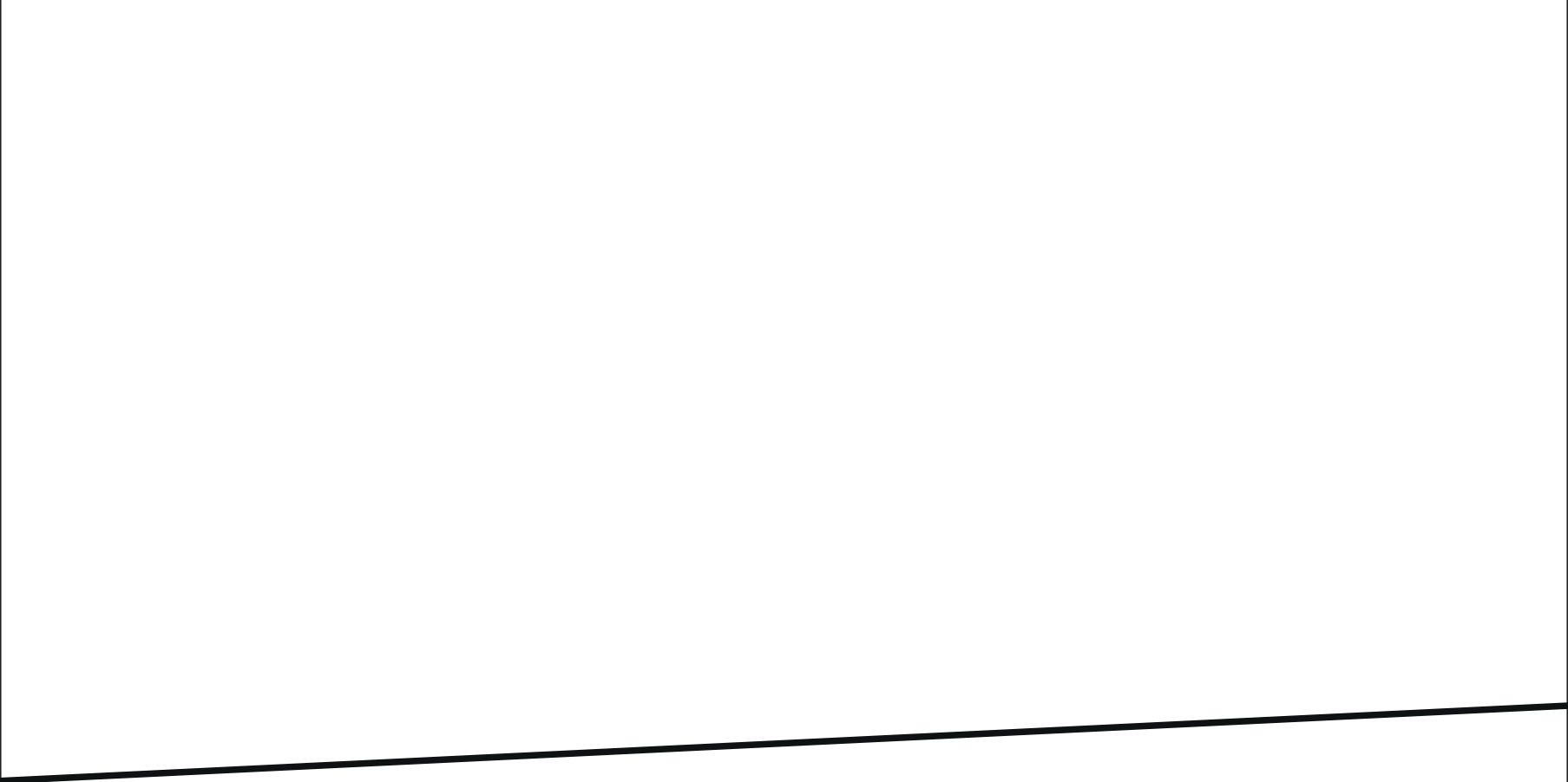
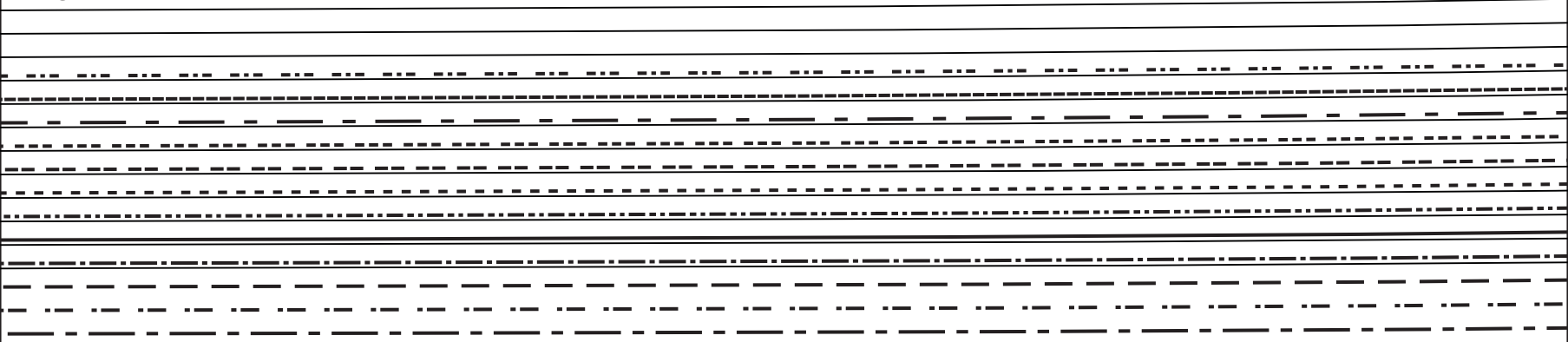

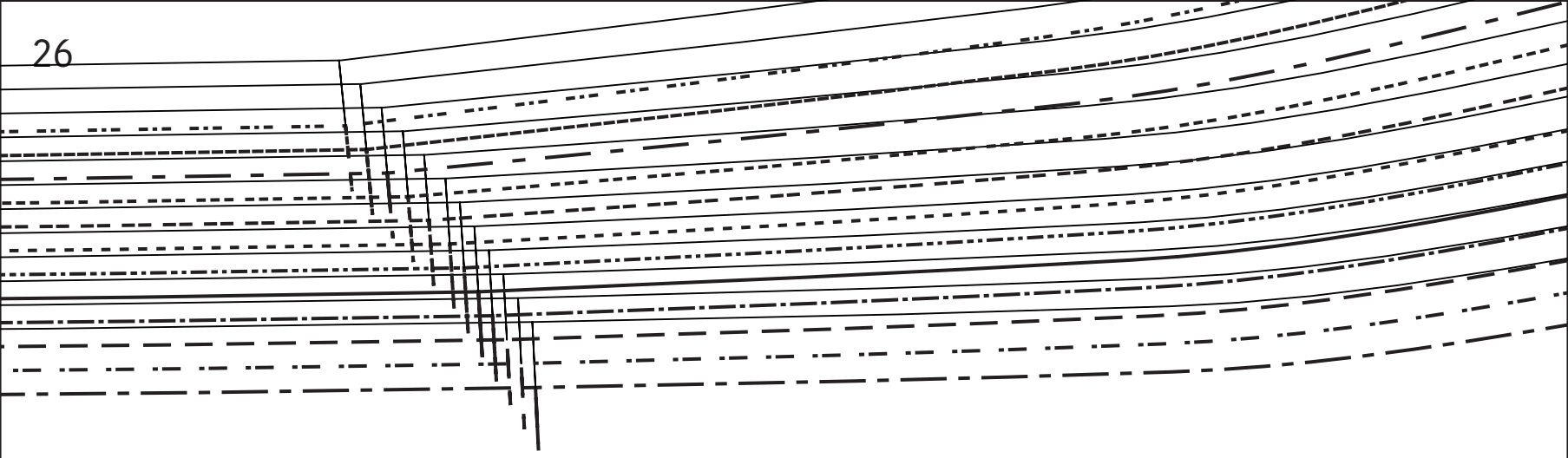

A

