

Patroonschema / Schéma du Patron / Pattern Diagram /
Übersichtsplan zum Zusammenkleben

Zeno

Shirt / T-shirt

Maten / Tailles / Sizes / Größen:

.....	XXS
-----	XS
-----	S
- . - . - . - . - . - .	M
-----	L
-----	XL
-----	XXL
-----	XXXL

Patroondelen / Pièces du patron / Pattern pieces / Schnittteile:

- A** voorpand / devant / front panel /
Vorderteil
- B** rugpand / dos / back panel /
Rückenteil
- C** mouw / manche / sleeve / Ärmel
- D** zak / poche / pocket / Tasche
- E** halsboord / liseré encolure / collar /
Halsbund

1	2	3	4	5	6
7	8	9	10	11	12
13	14	15	16	17	18
19	20	21	22	23	24
25	26	27	28	29	30

Controlevierkant / Carré de controle / Test square / Kontrollquadrat

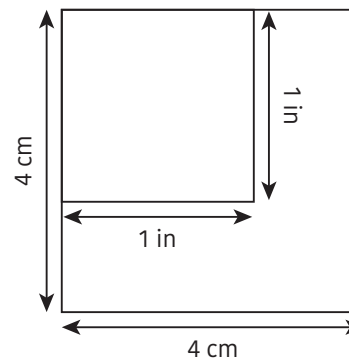

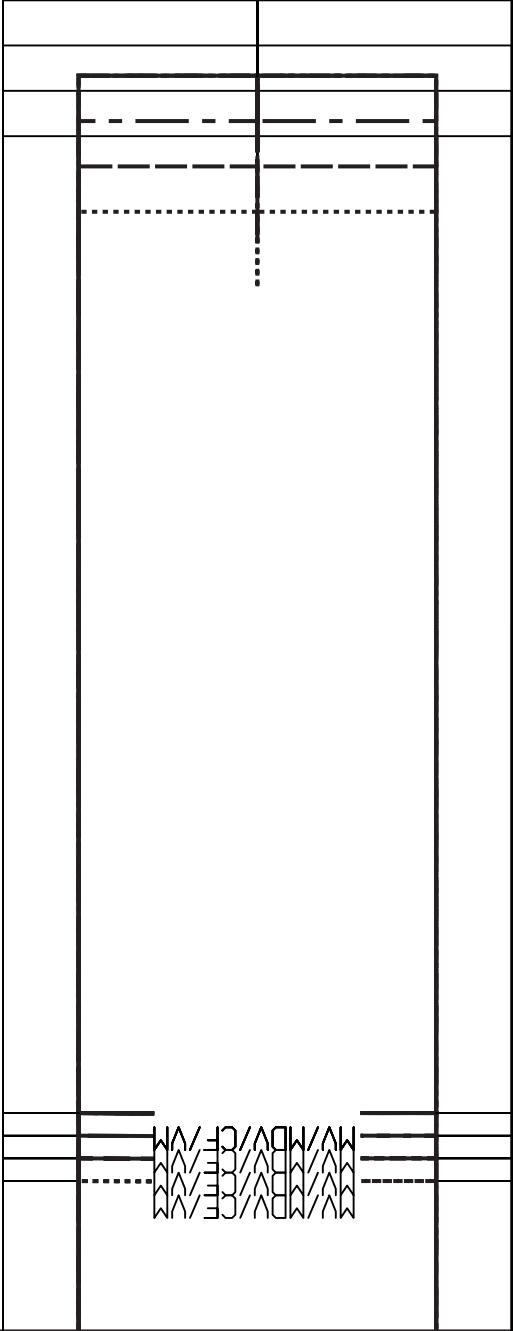

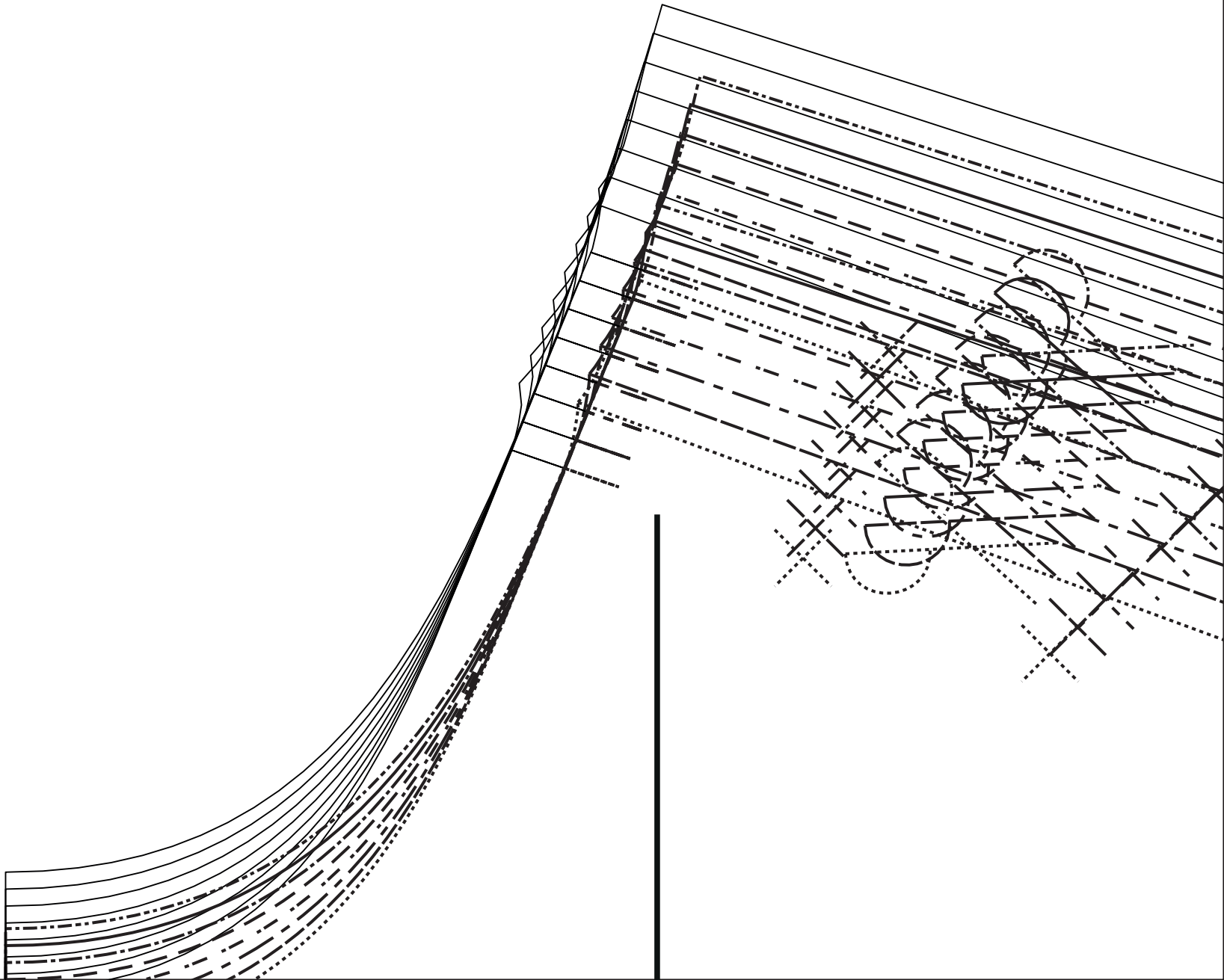

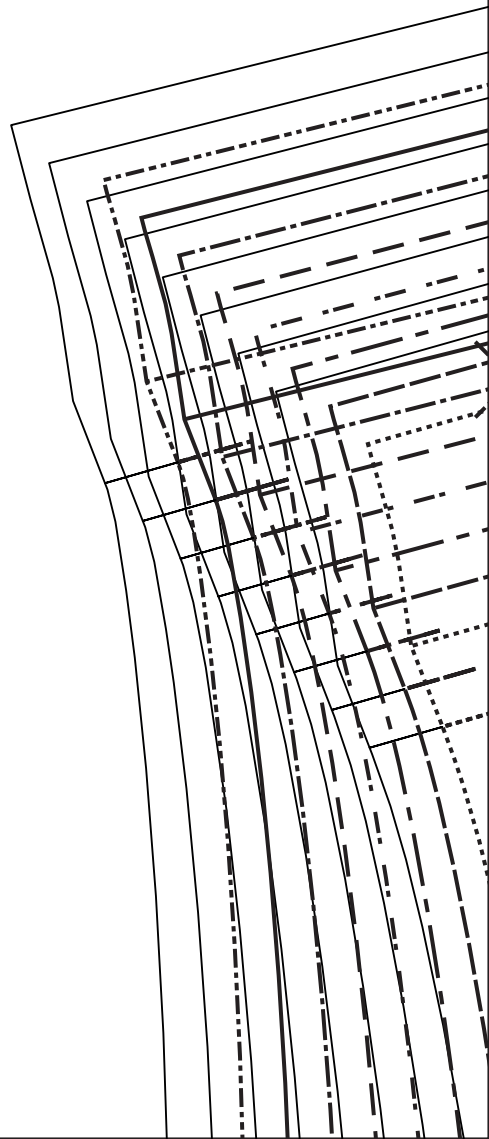
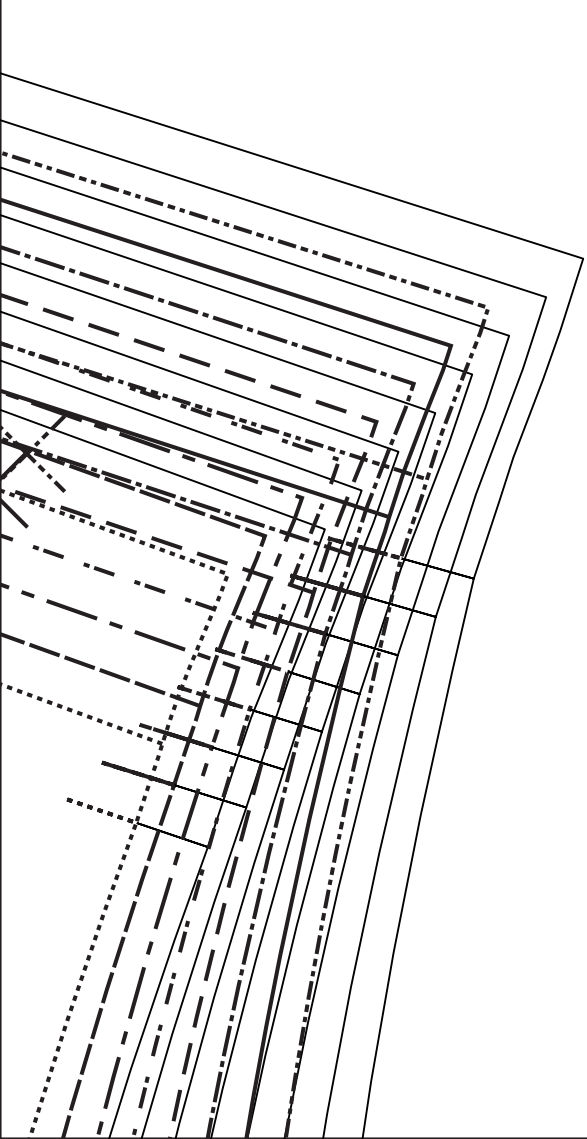

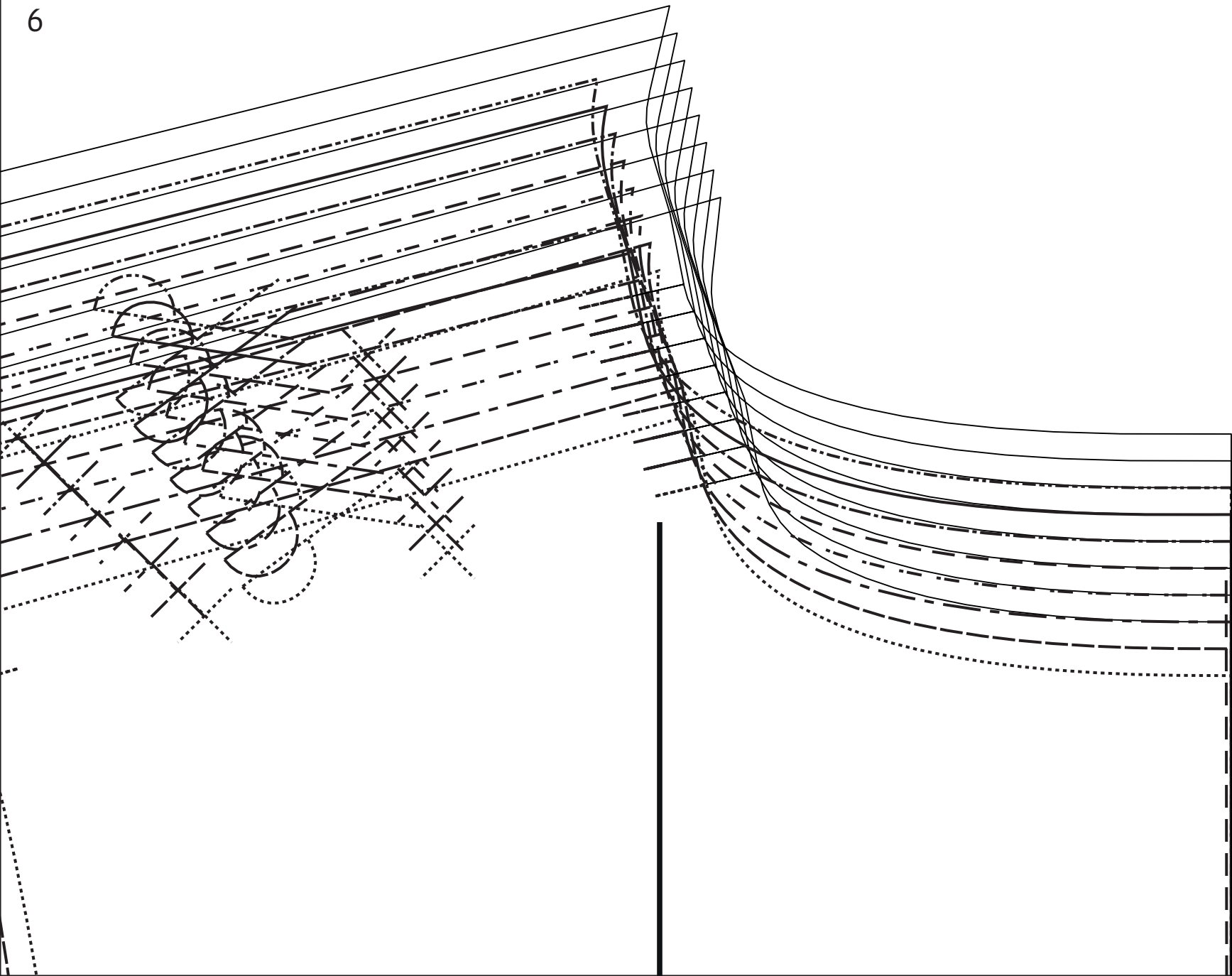

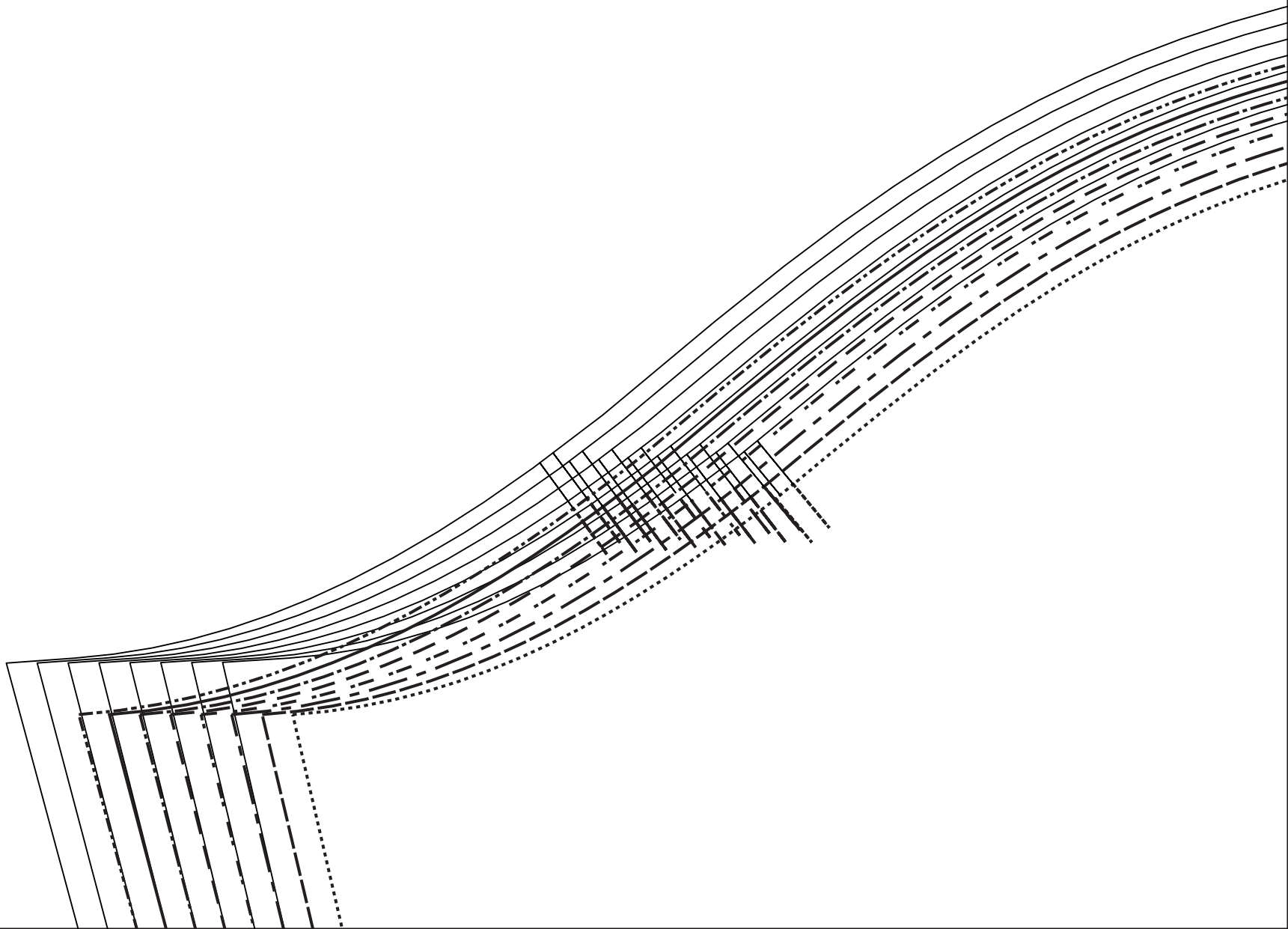

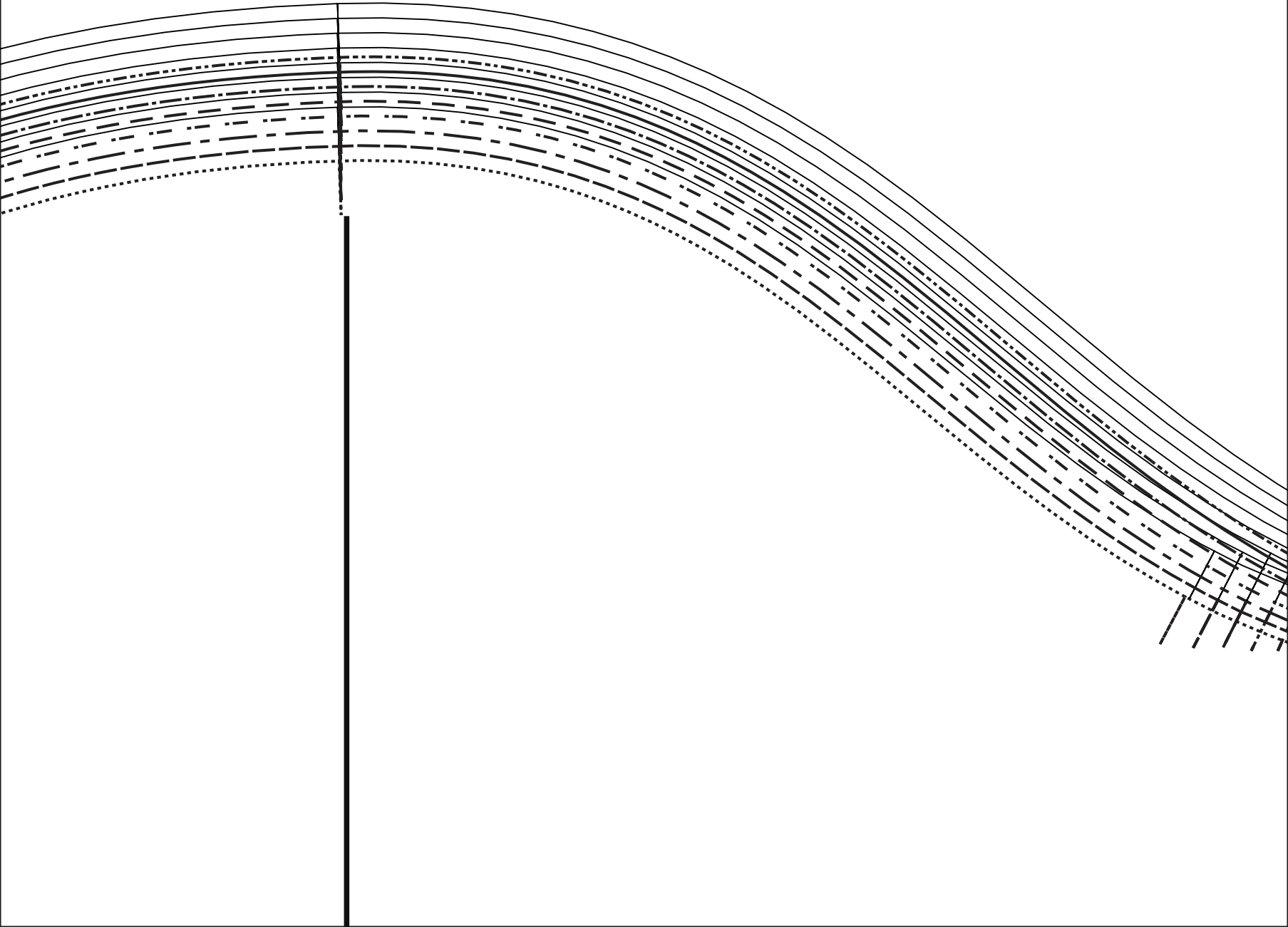

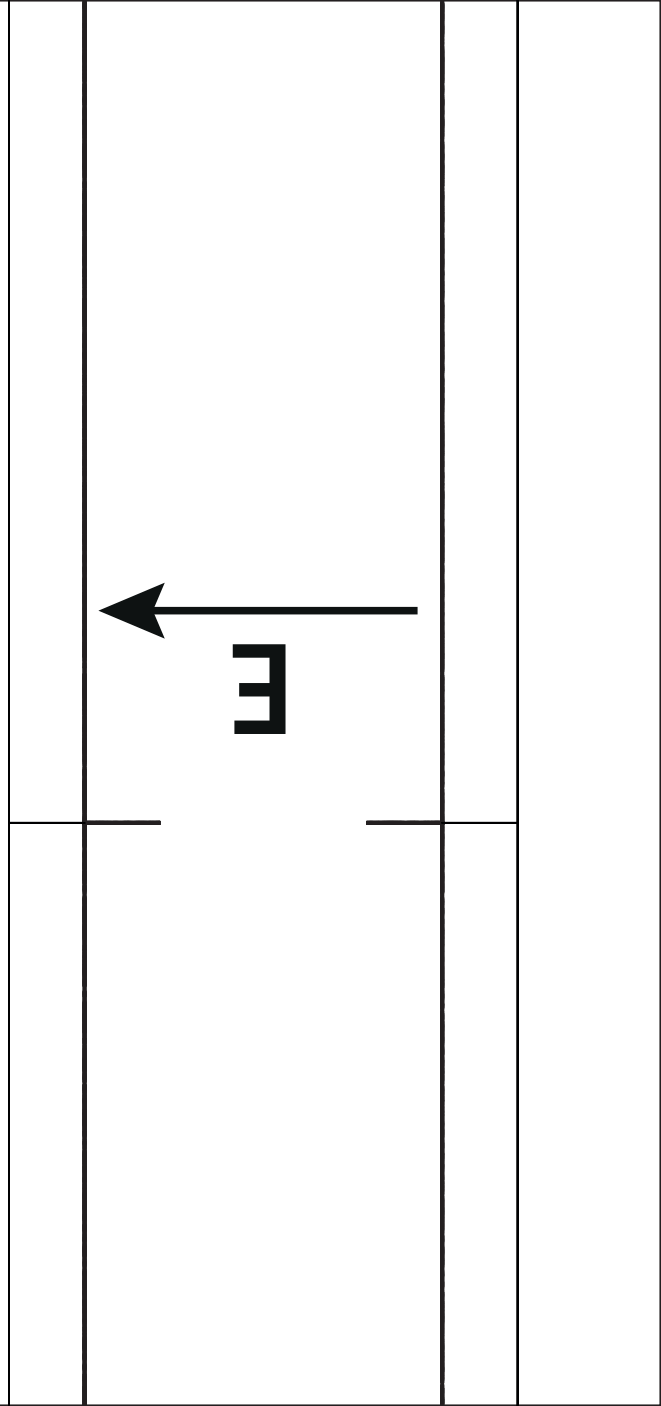
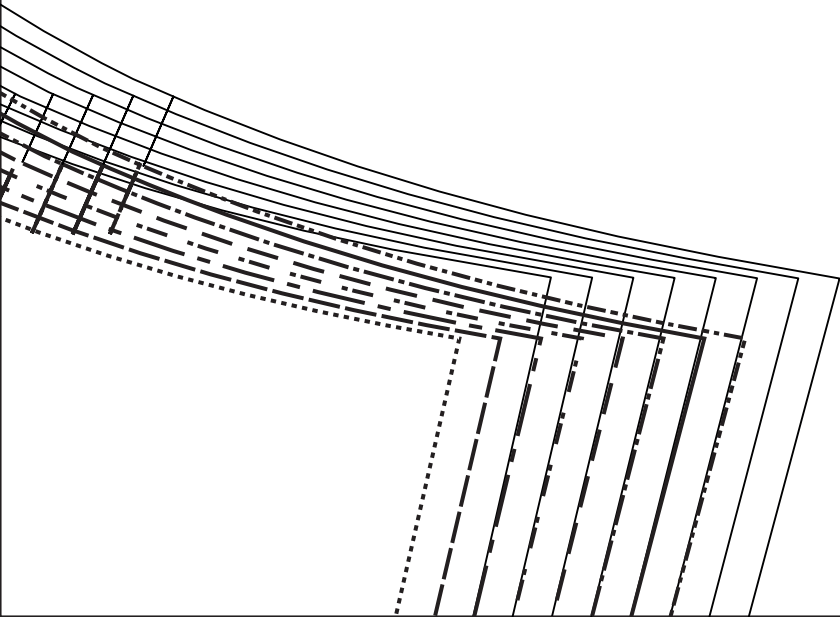

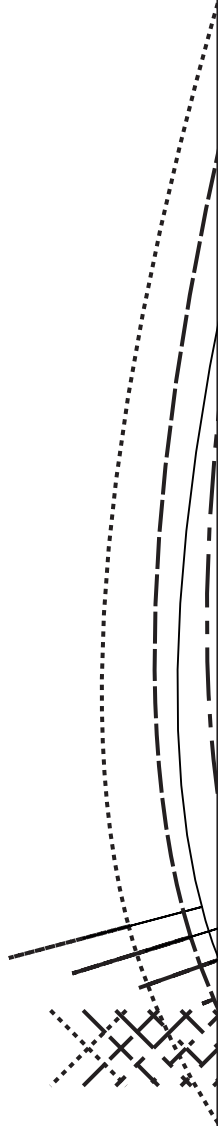

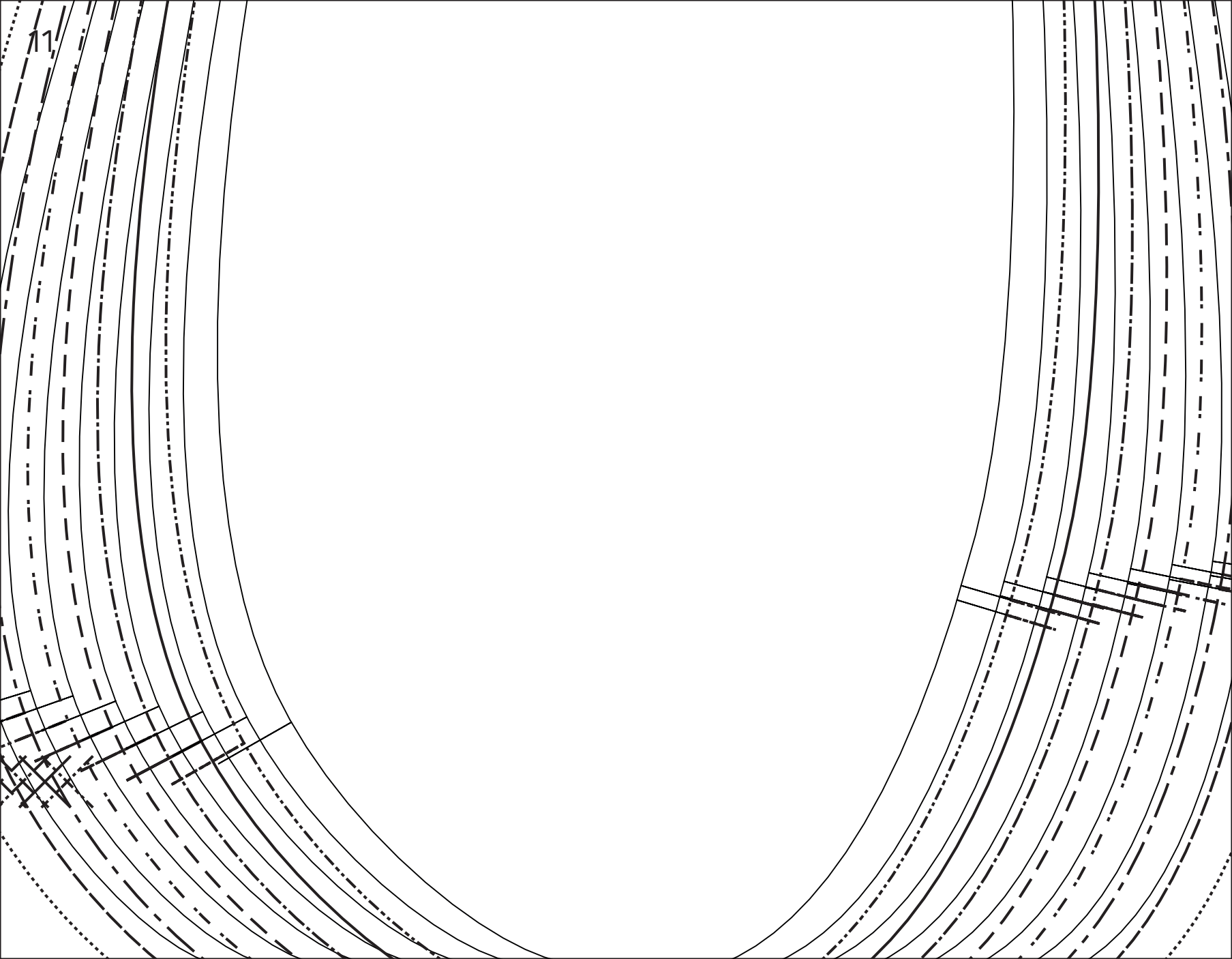

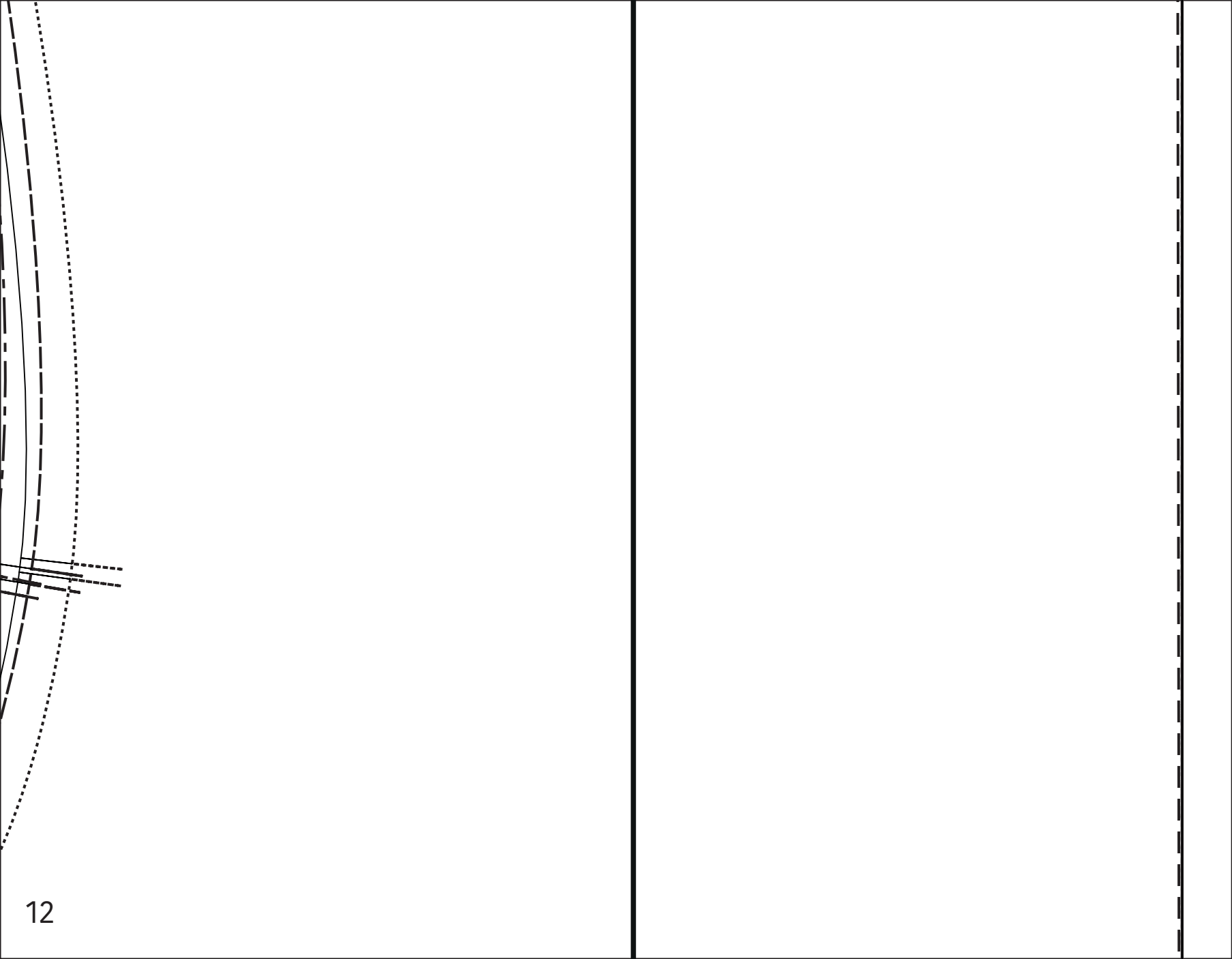

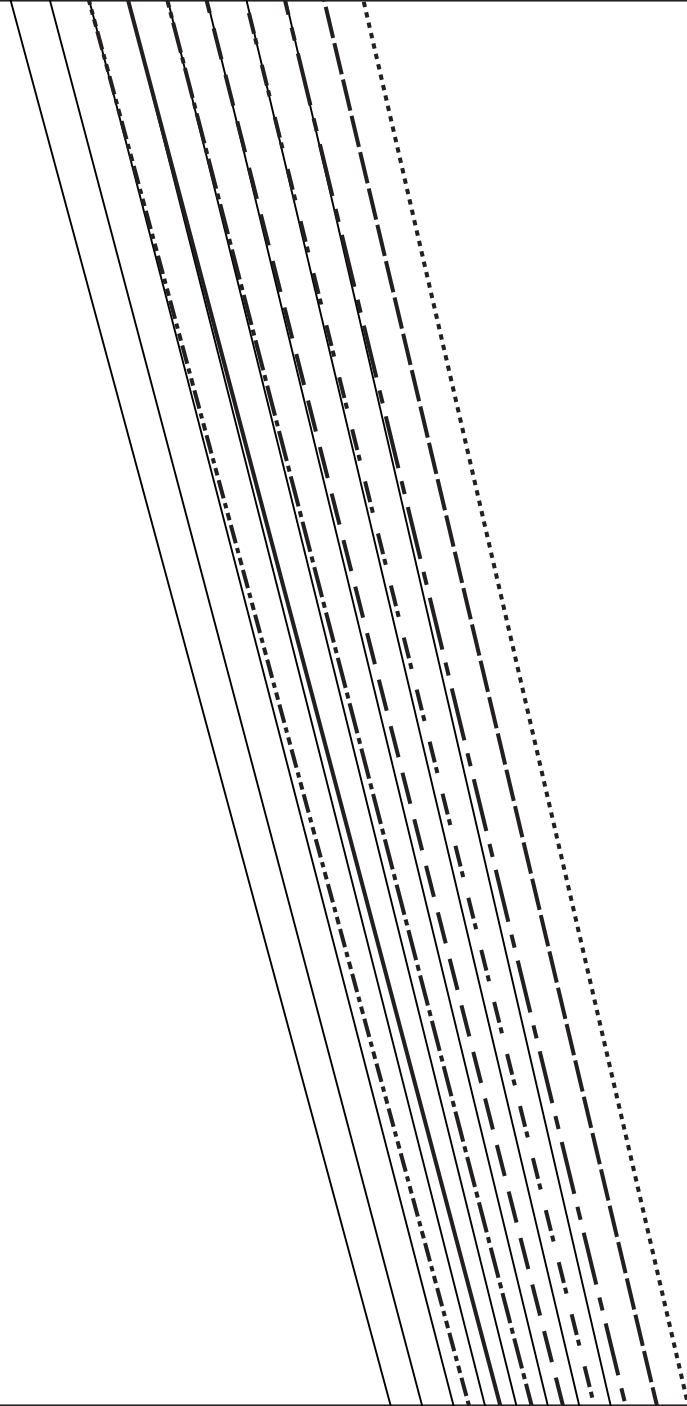

C

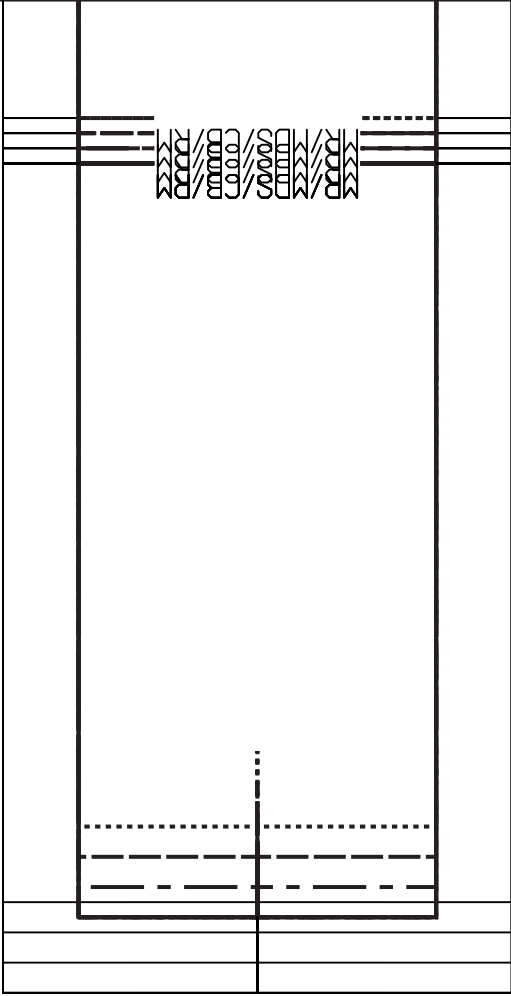
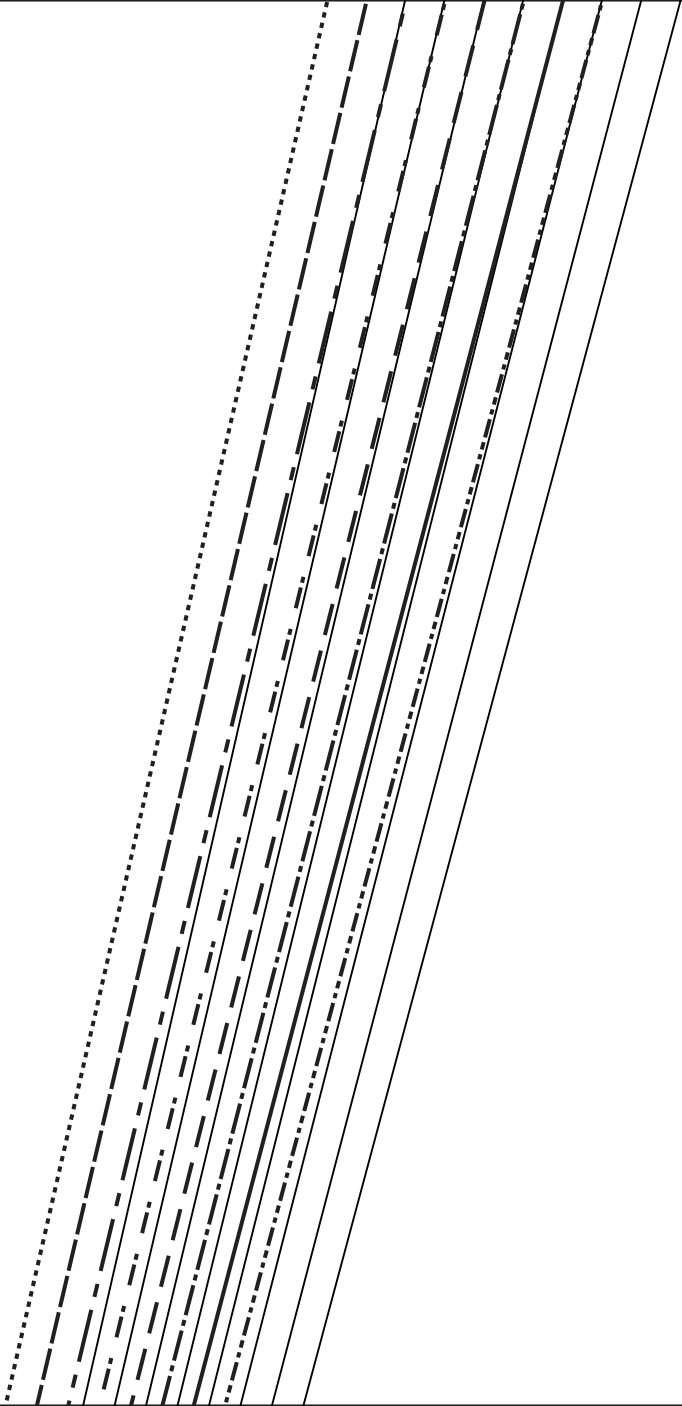



MV/MDV/CF/VM

A

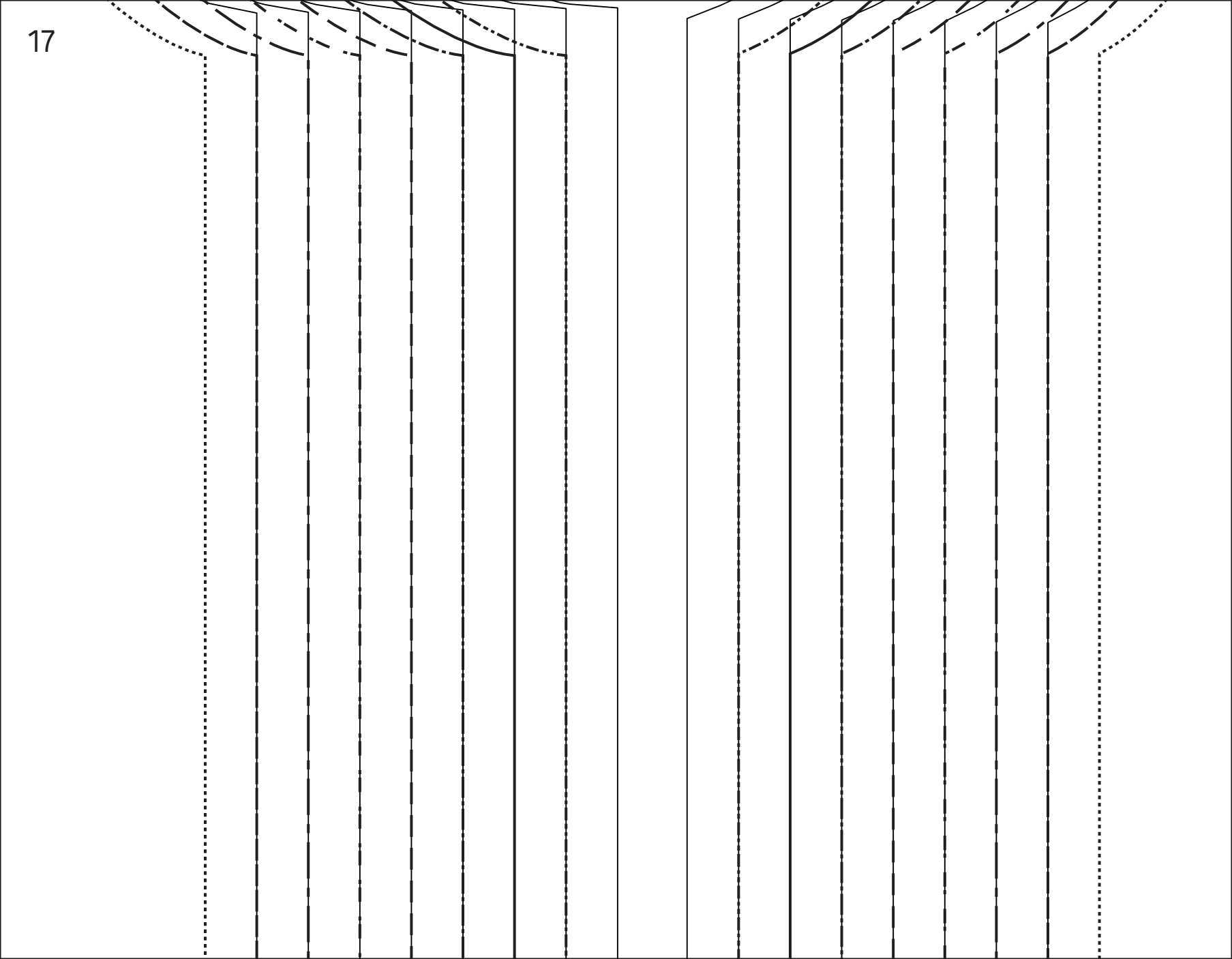

B

MR/MDS/CB/RM



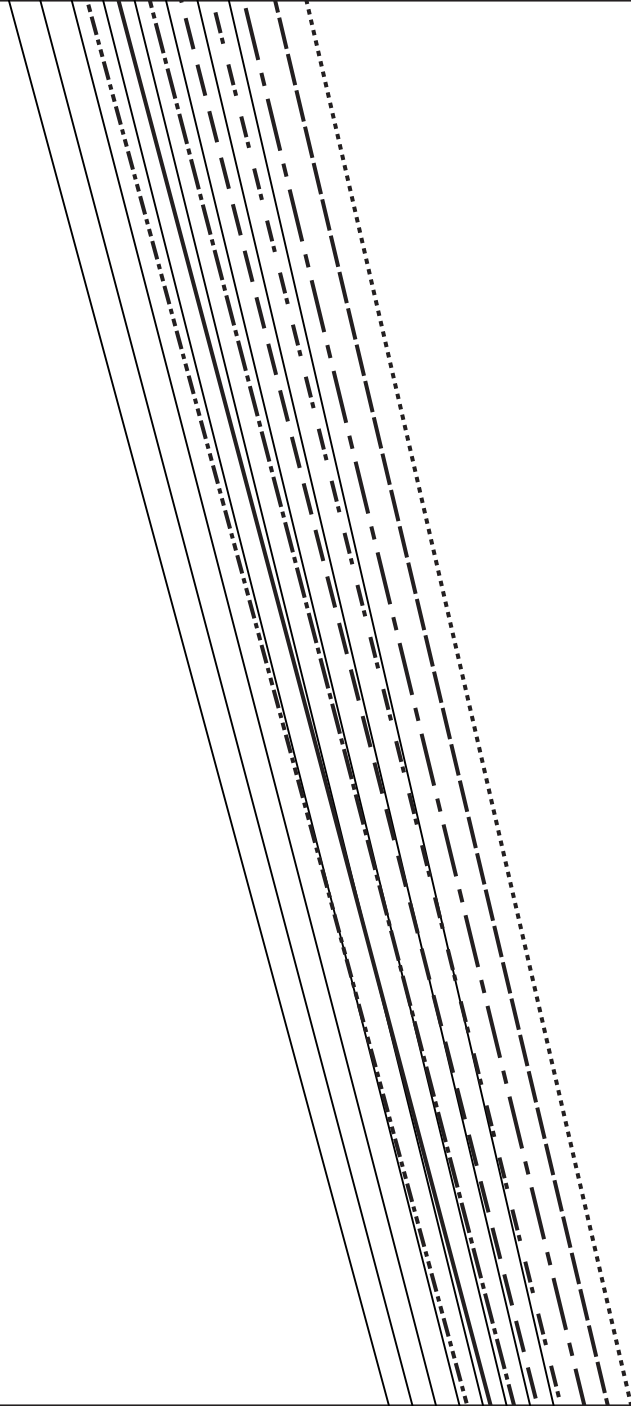

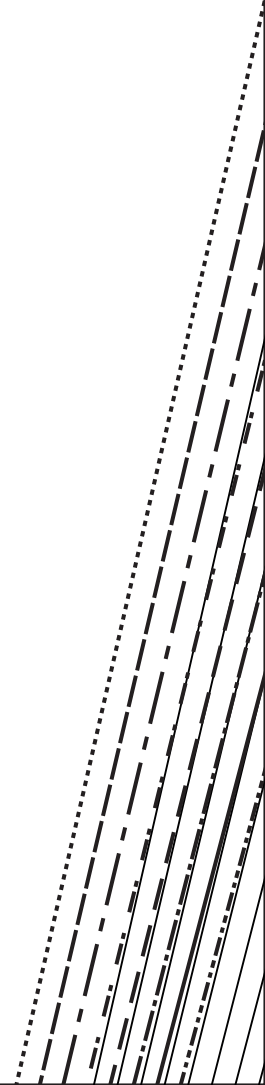

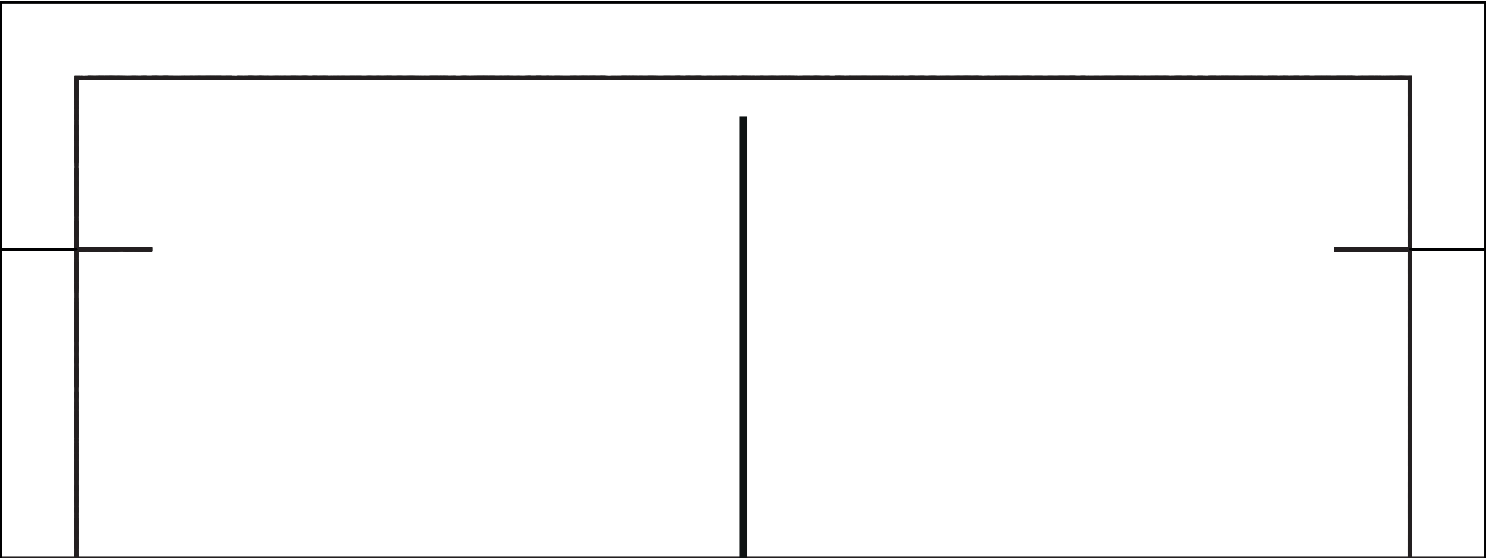
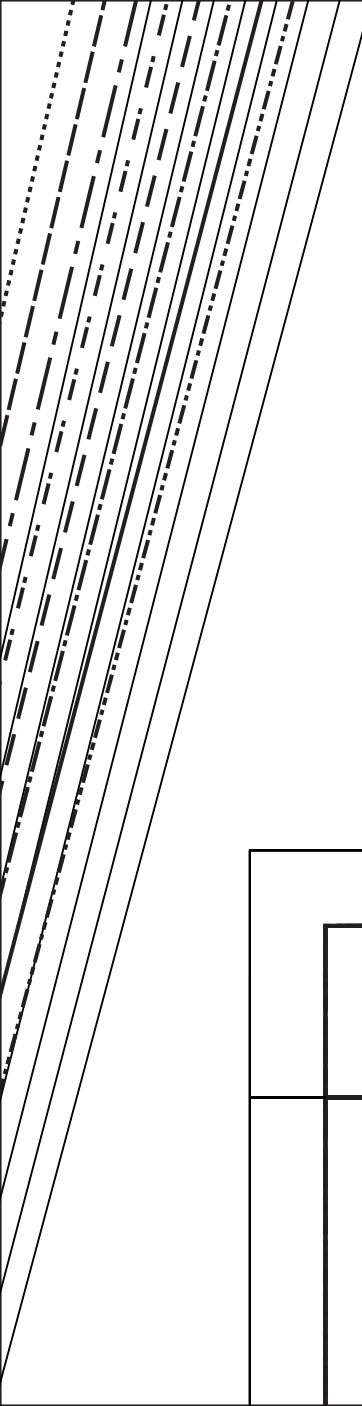

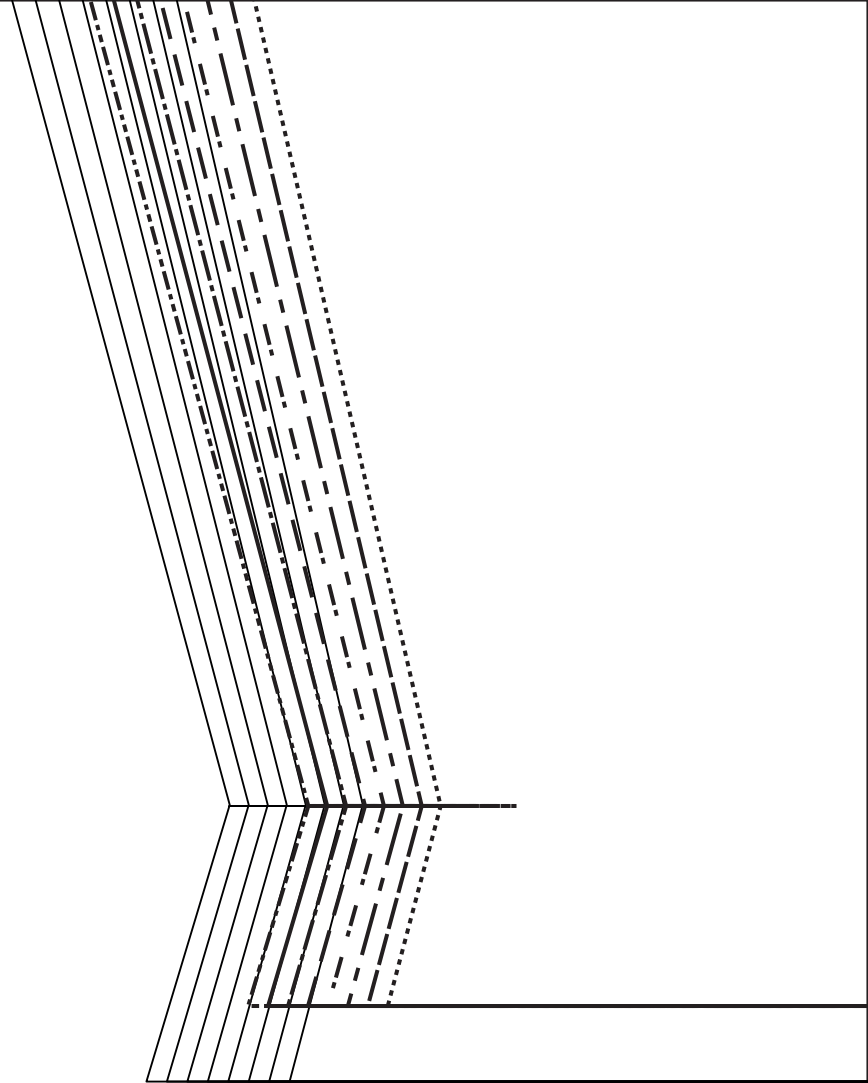

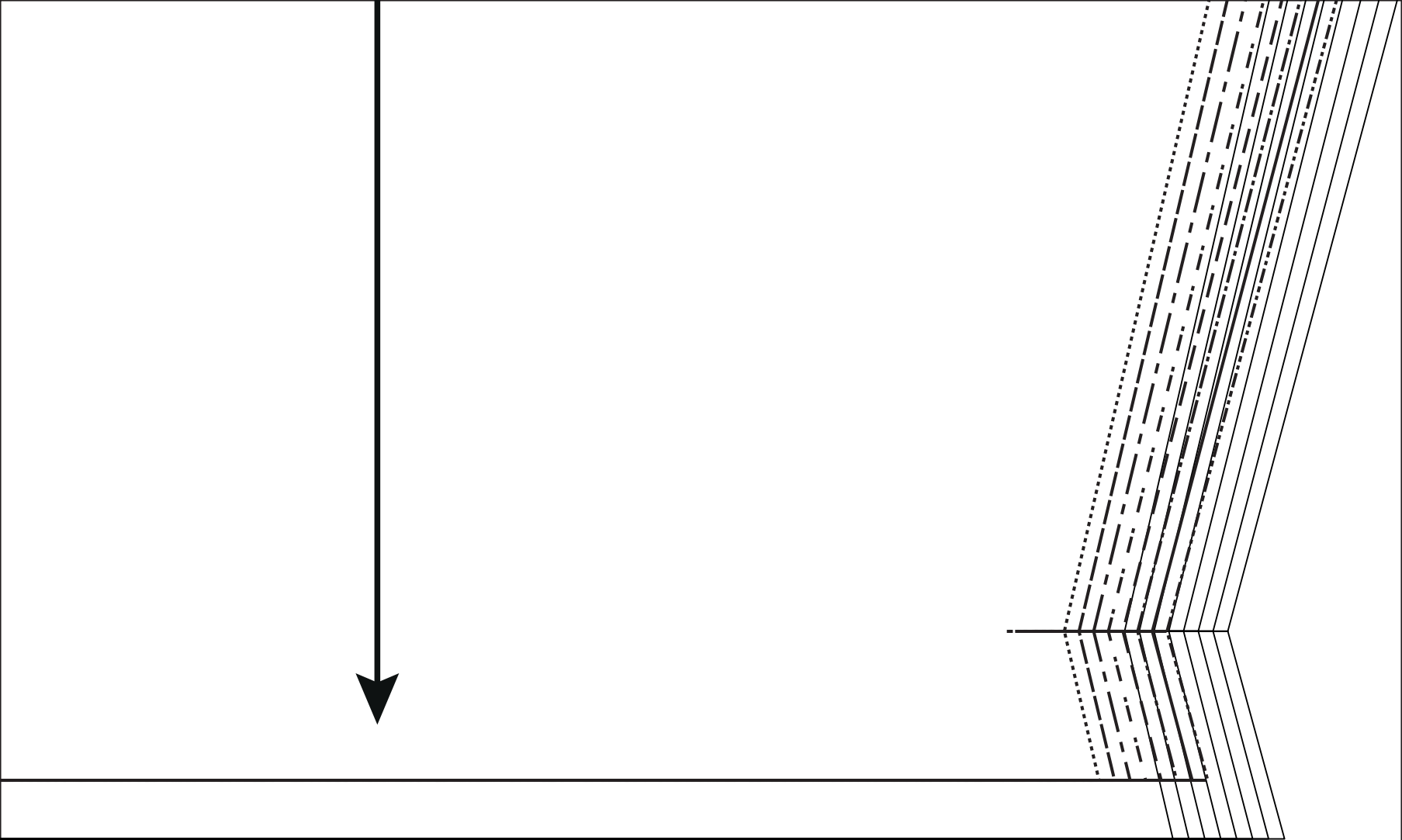



D

