

Hanni

Blouse / Bluse

Maten / Tailles / Sizes / Größen:

-----	34
-----	36
-----	38
-----	40
-----	42
-----	44
-----	46
-----	48
-----	50
-----	52
-----	54
-----	56

Patroondelen / Pièces du patron / Pattern pieces / Schnittteile:

- A** voorpand / devant / front panel /
Vorderteil
- B** rugpand / dos / back panel /
Rückenteil
- C** tailleband VP / ceinture devant /
waistband front / Bund VT
- D** tailleband RP / ceinture dos /
waistband back / Bund RT
- E** beleg RP / parementure du dos /
facing back / Besatz RT

1	2	3	4	5	6
7	8	9	10	11	12
13	14	15	16	17	18
19	20	21	22	23	24
25	26	27	28	29	30
31	32	33	34	35	36

Controlevierkant / Carré de controle
/ Test square / Kontrollquadrat

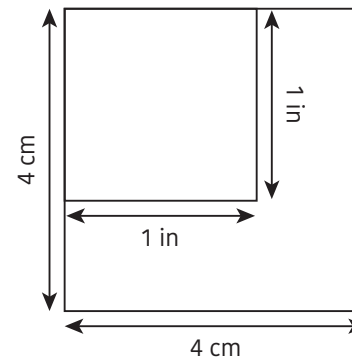

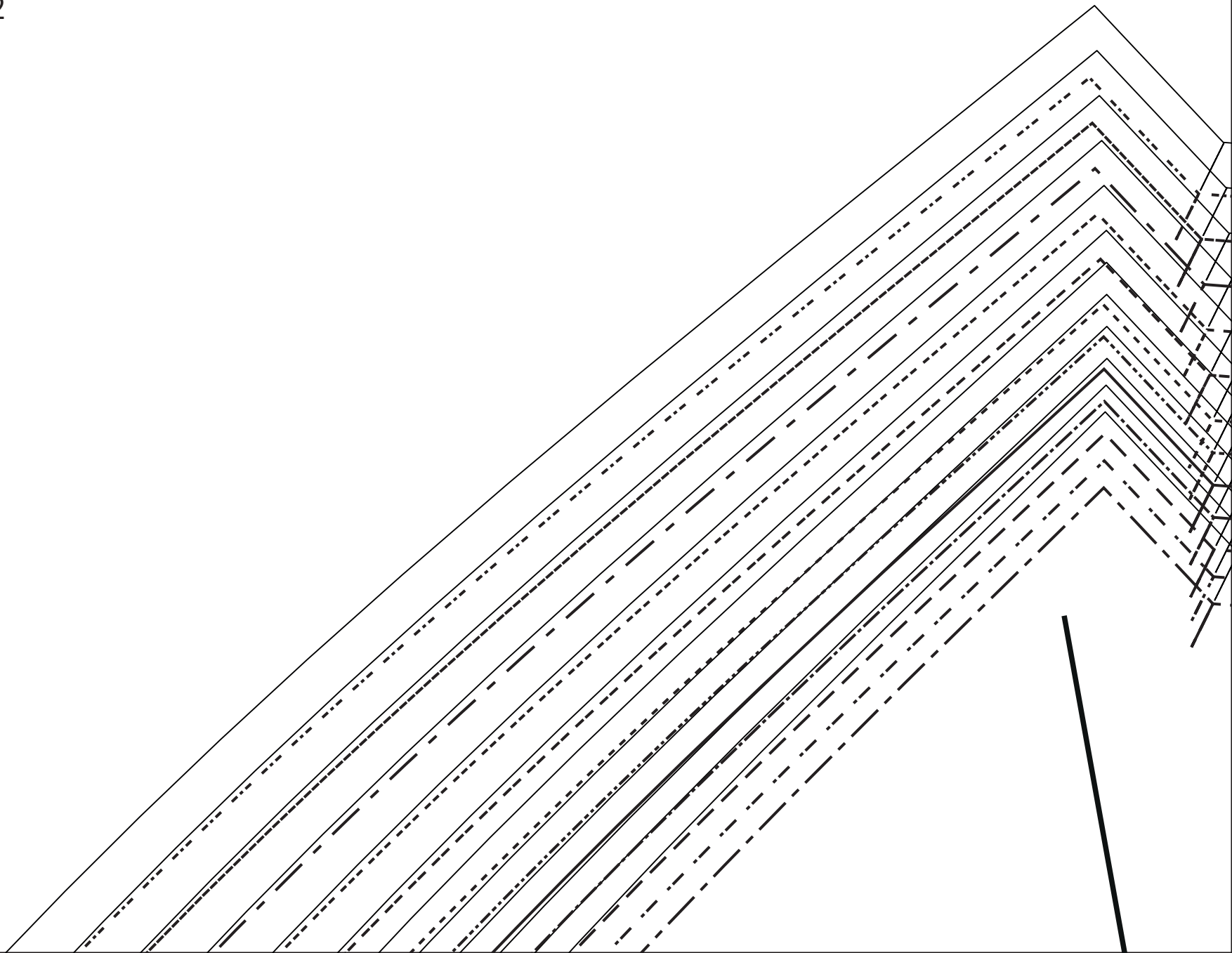

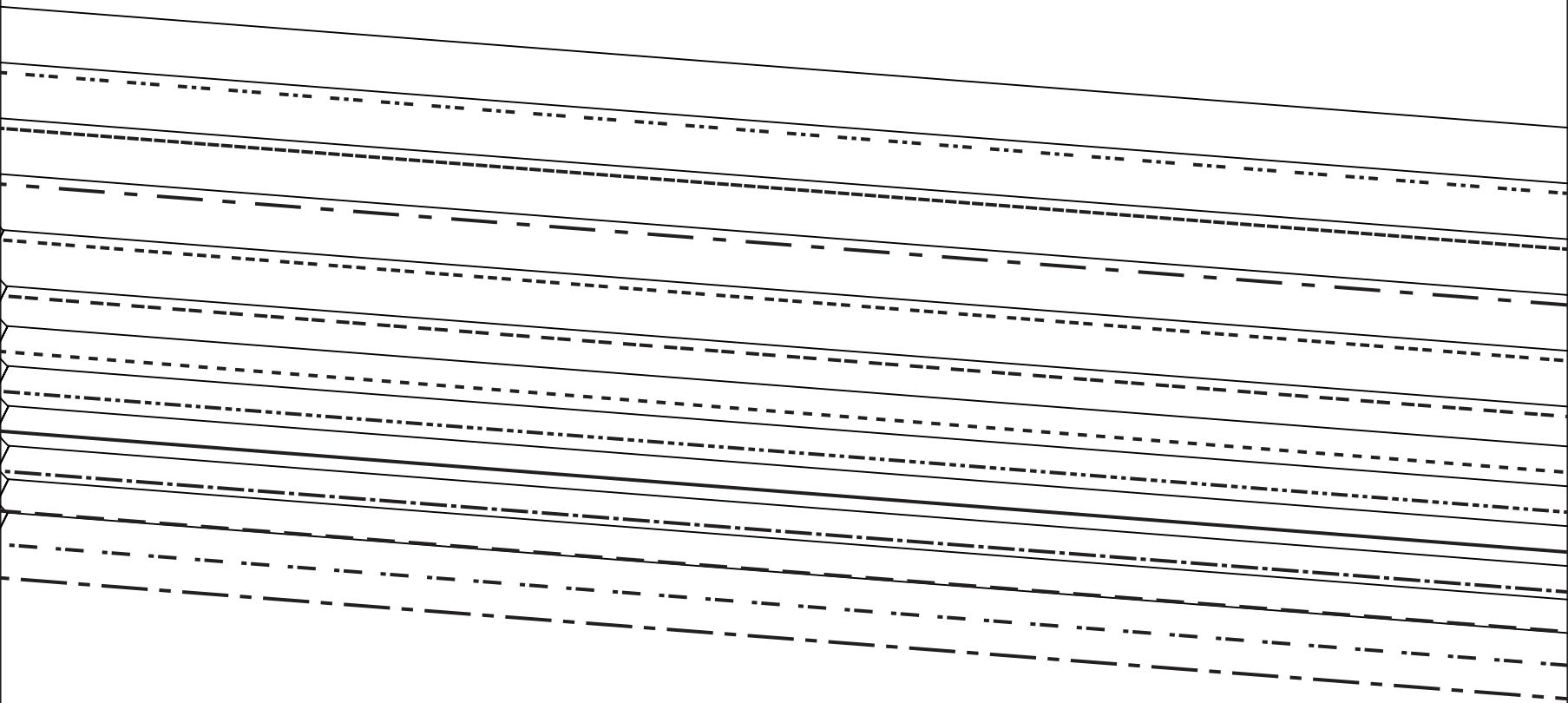

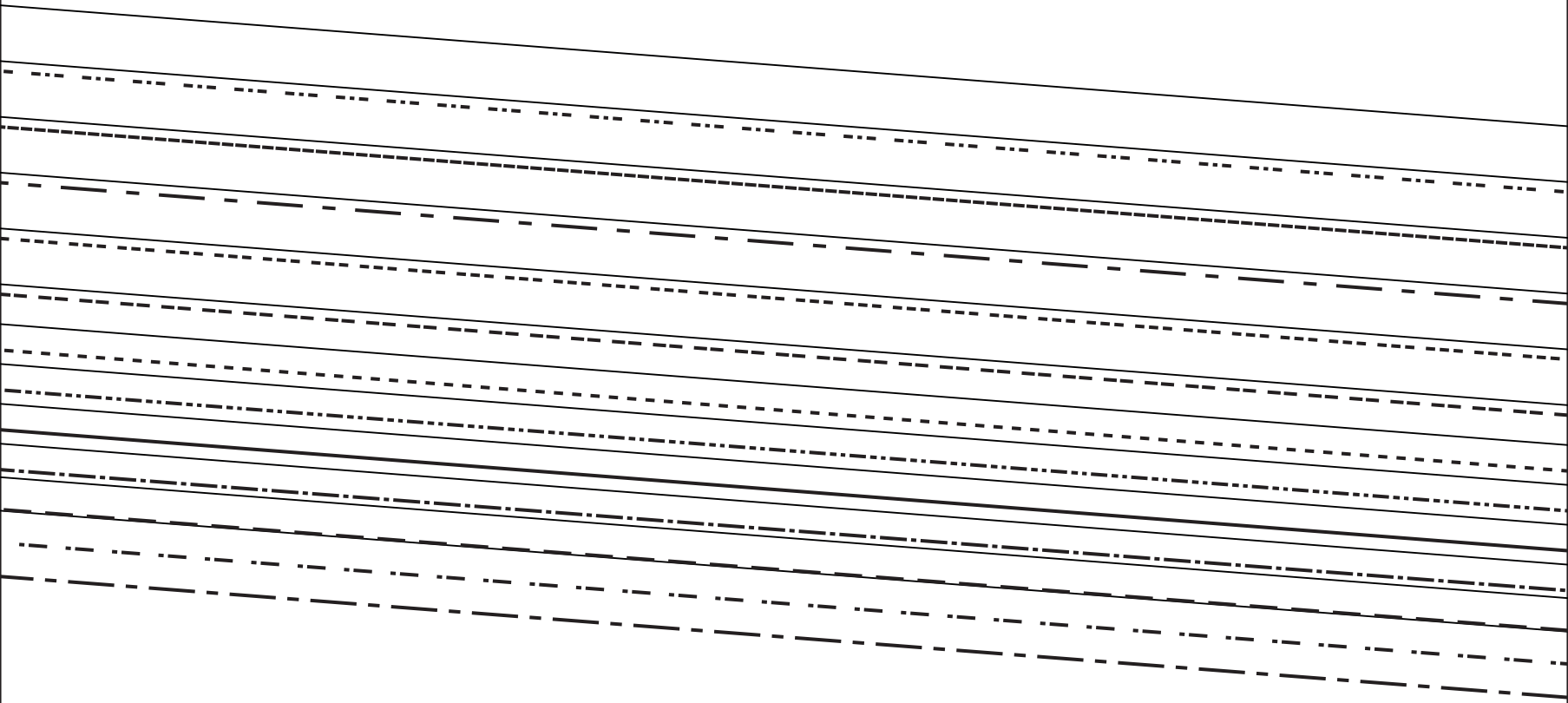

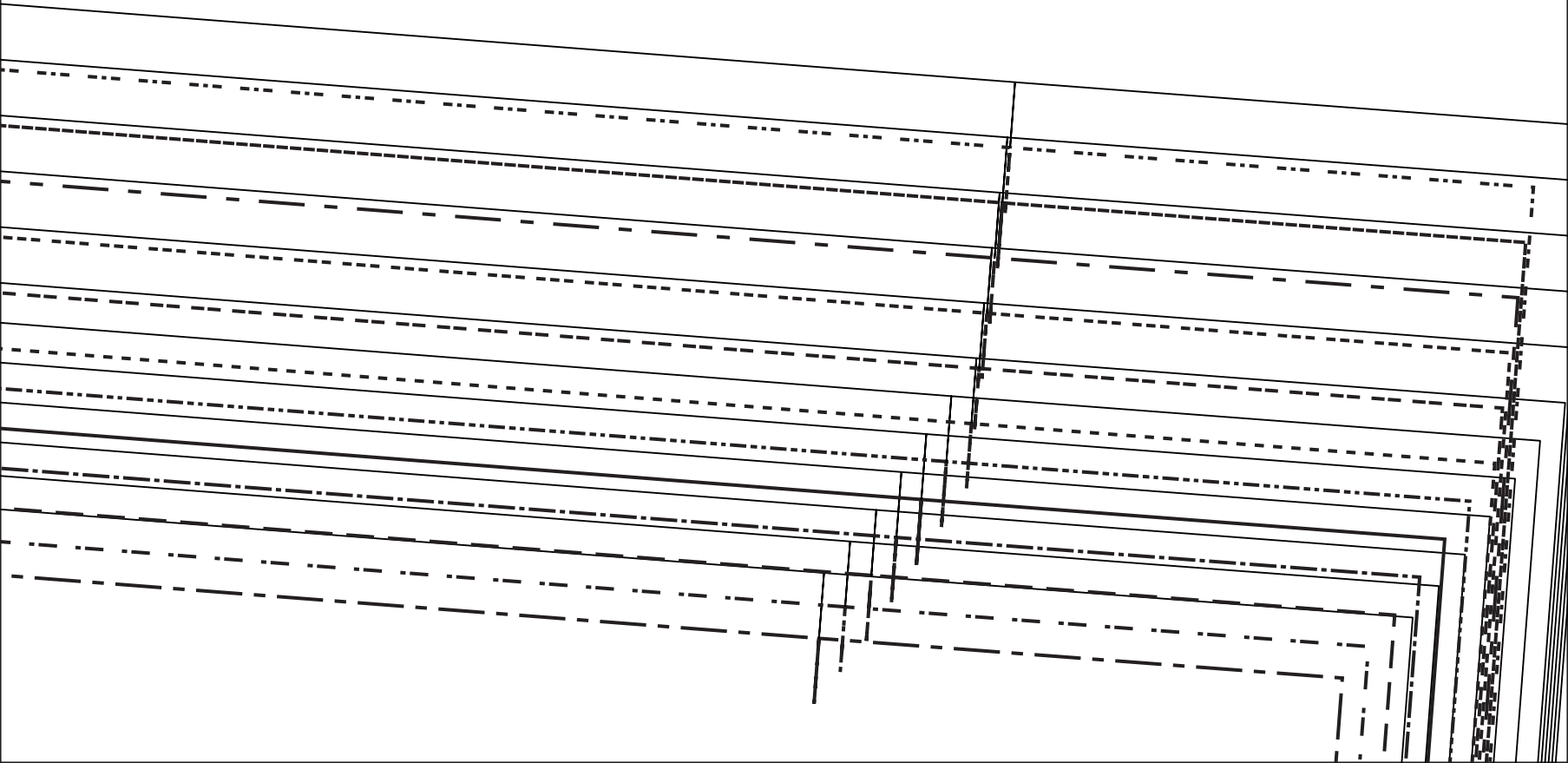



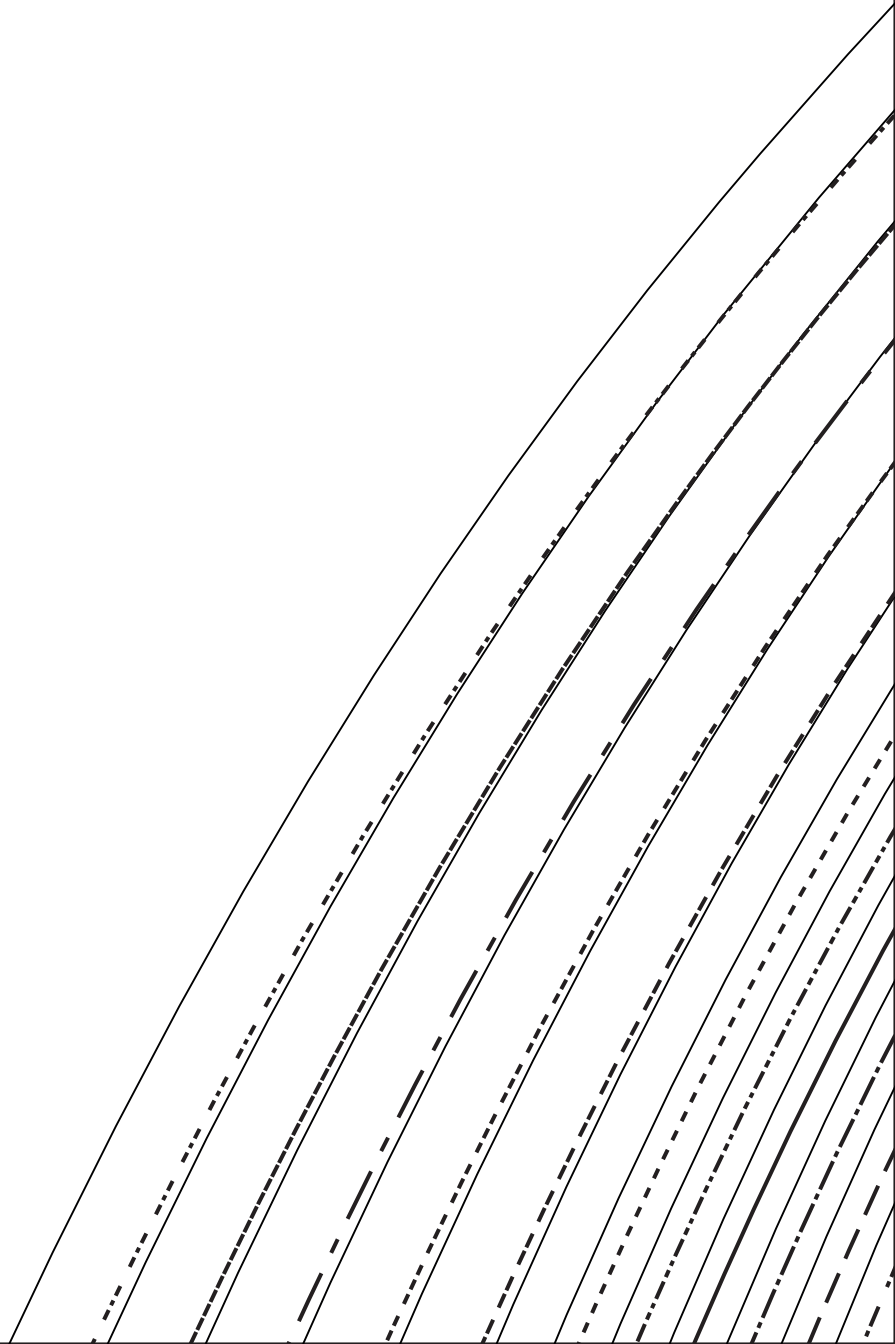

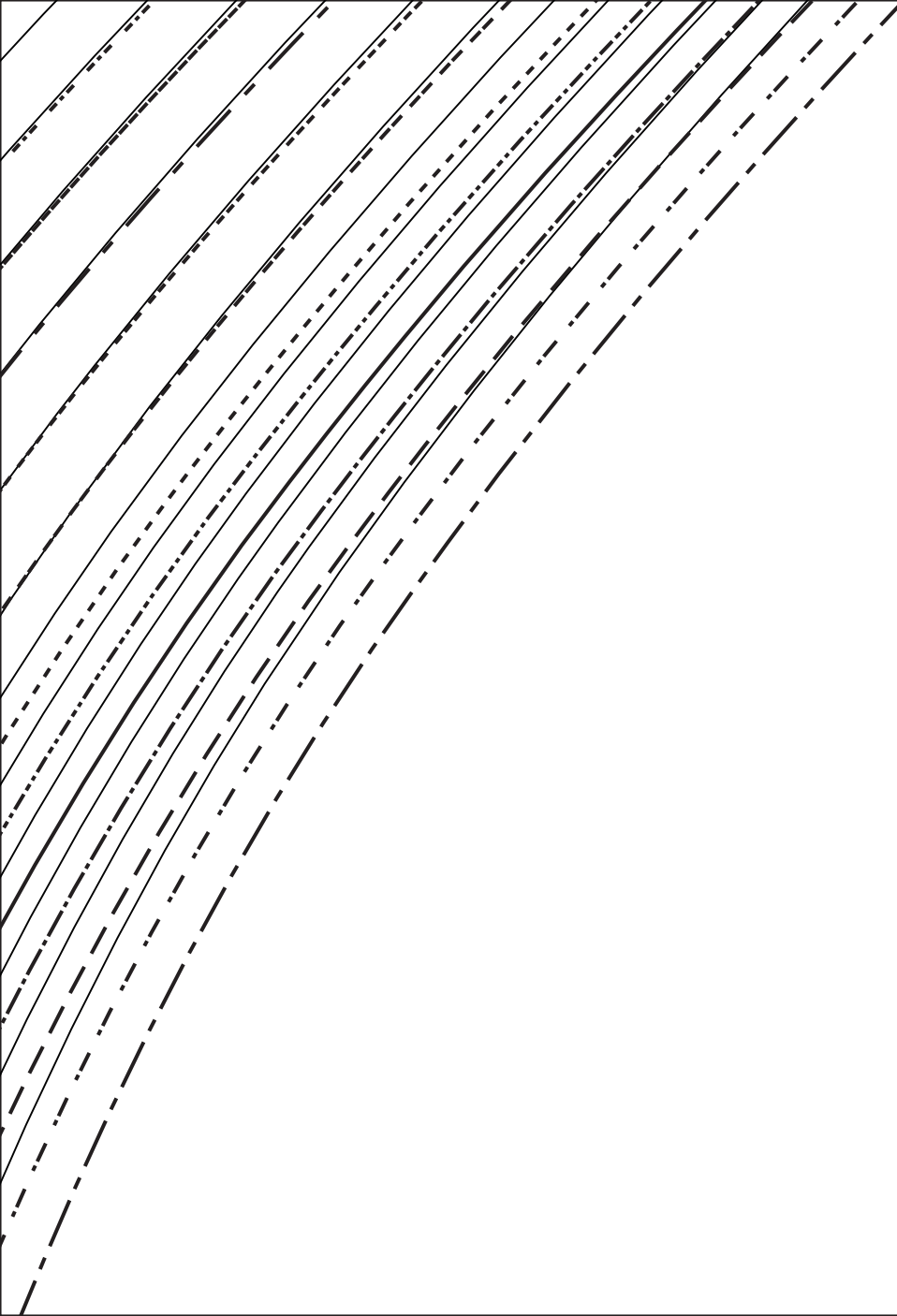



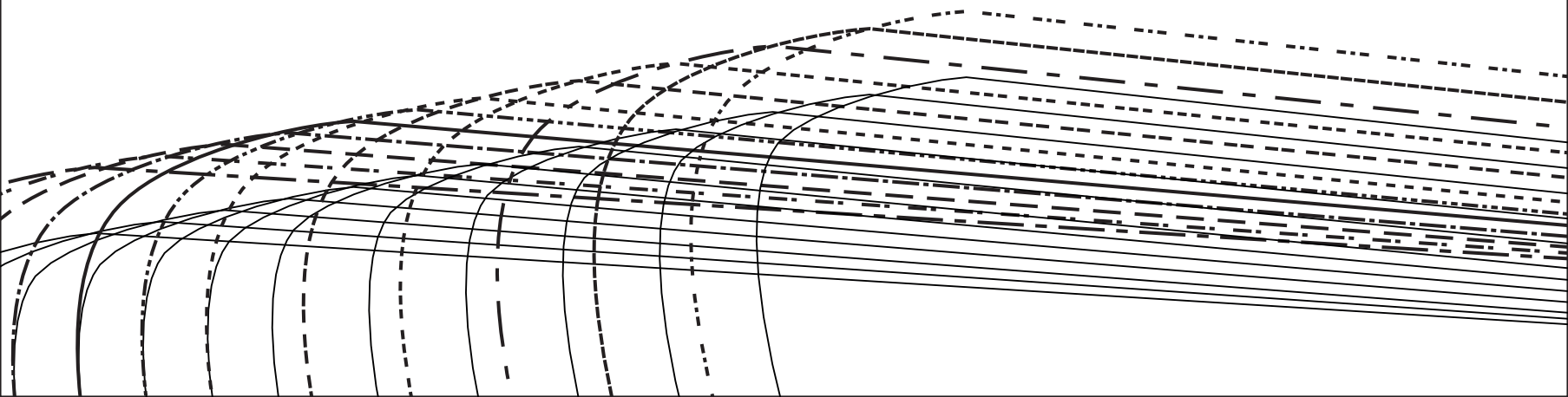

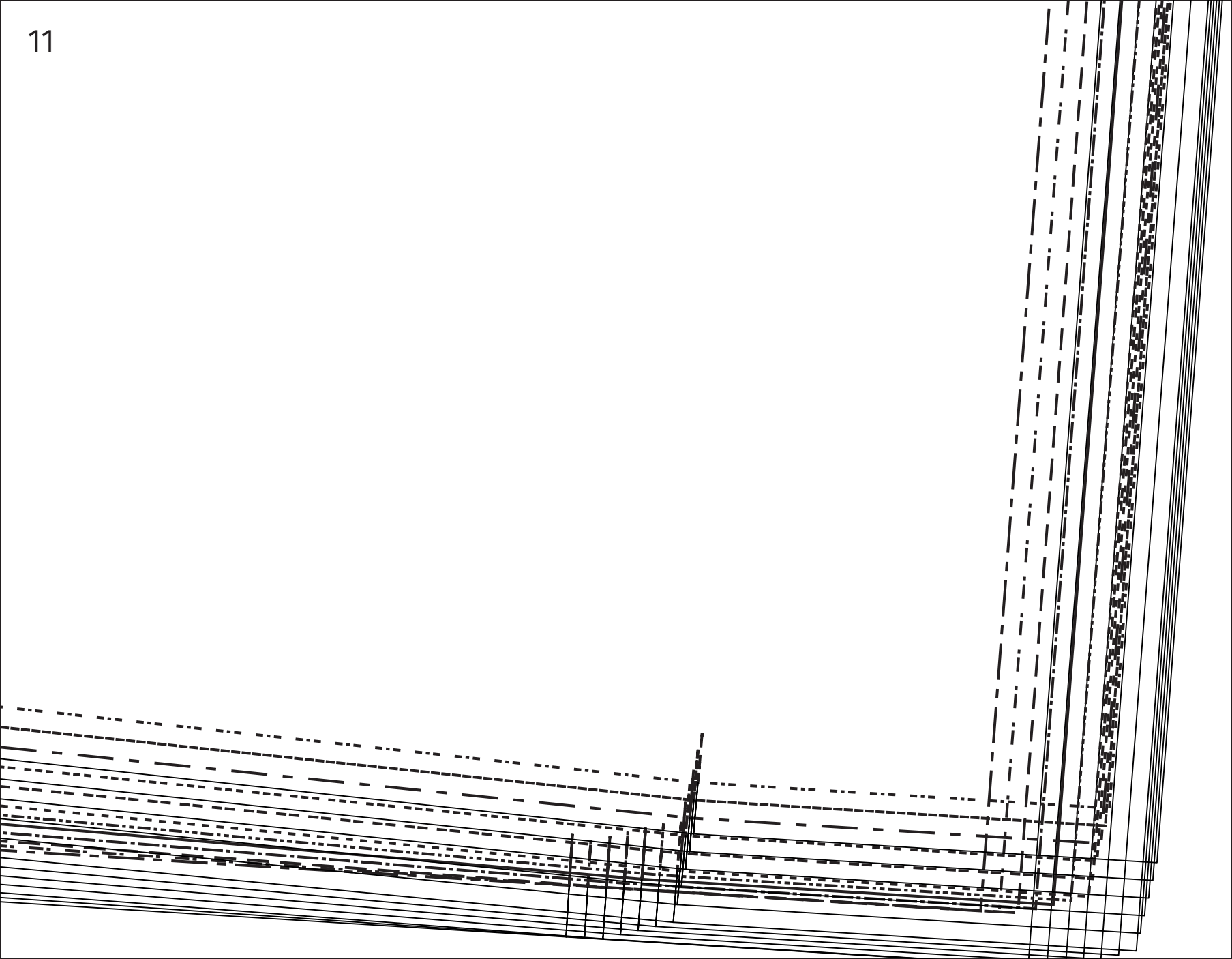

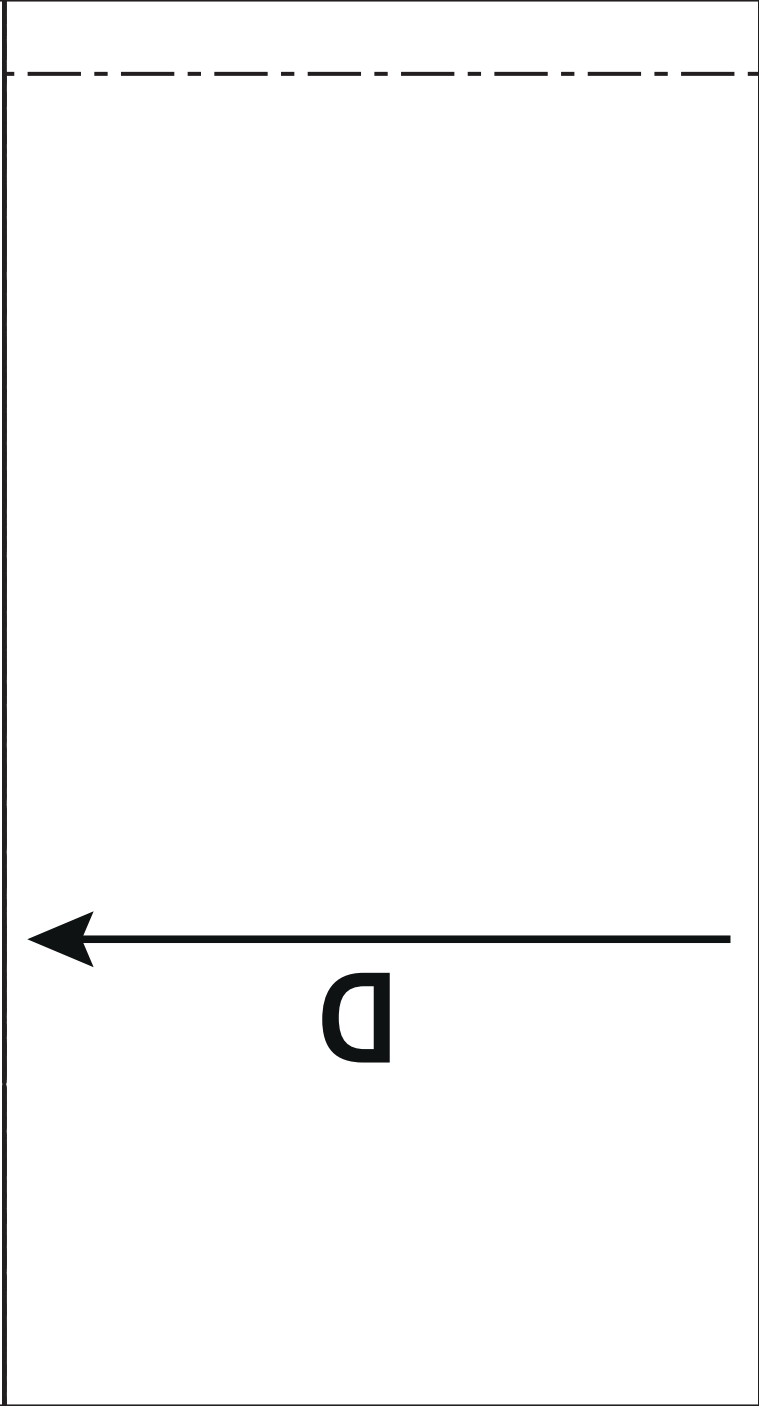

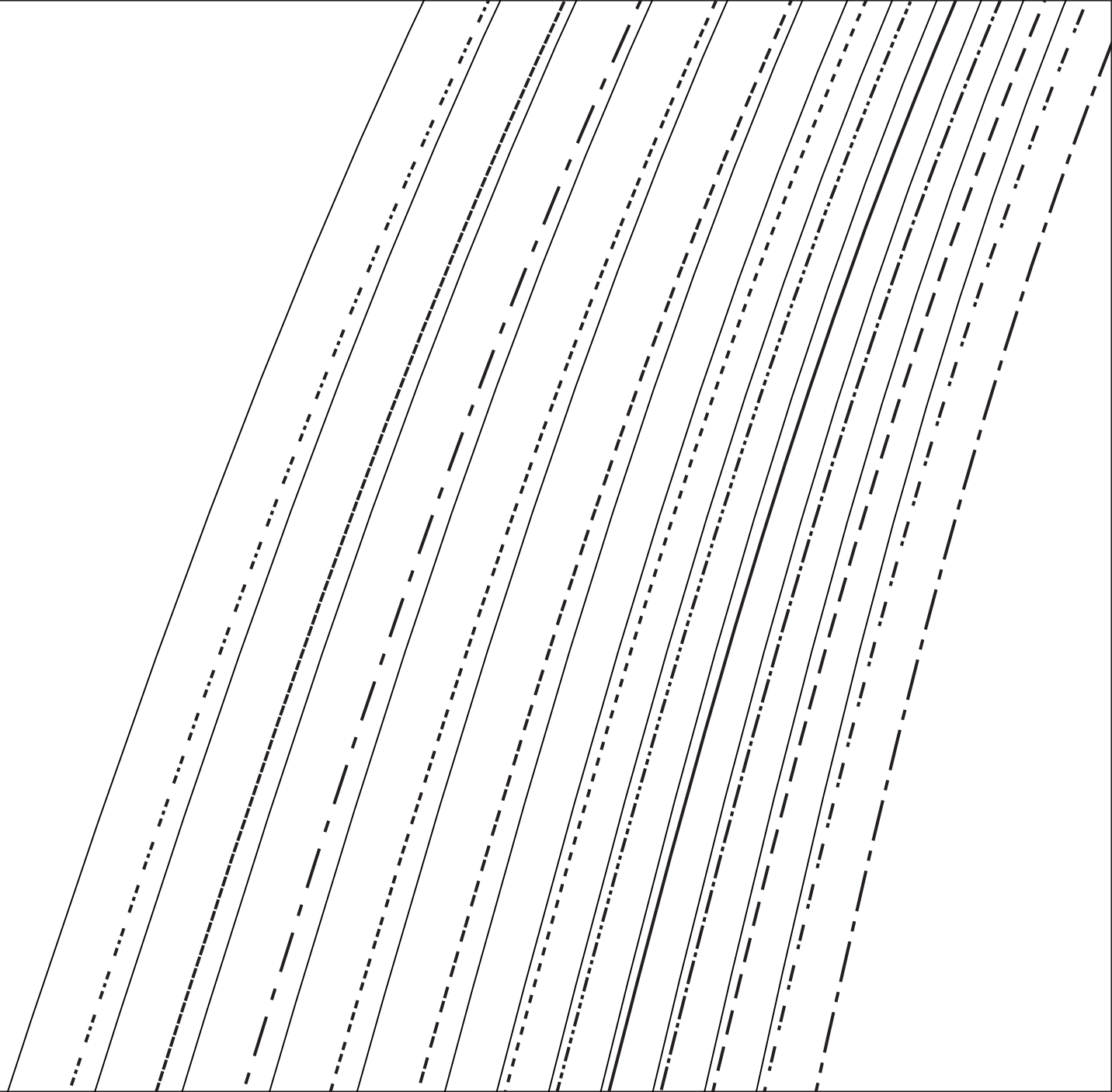

15

A

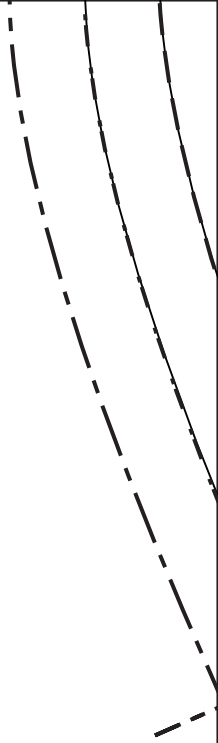

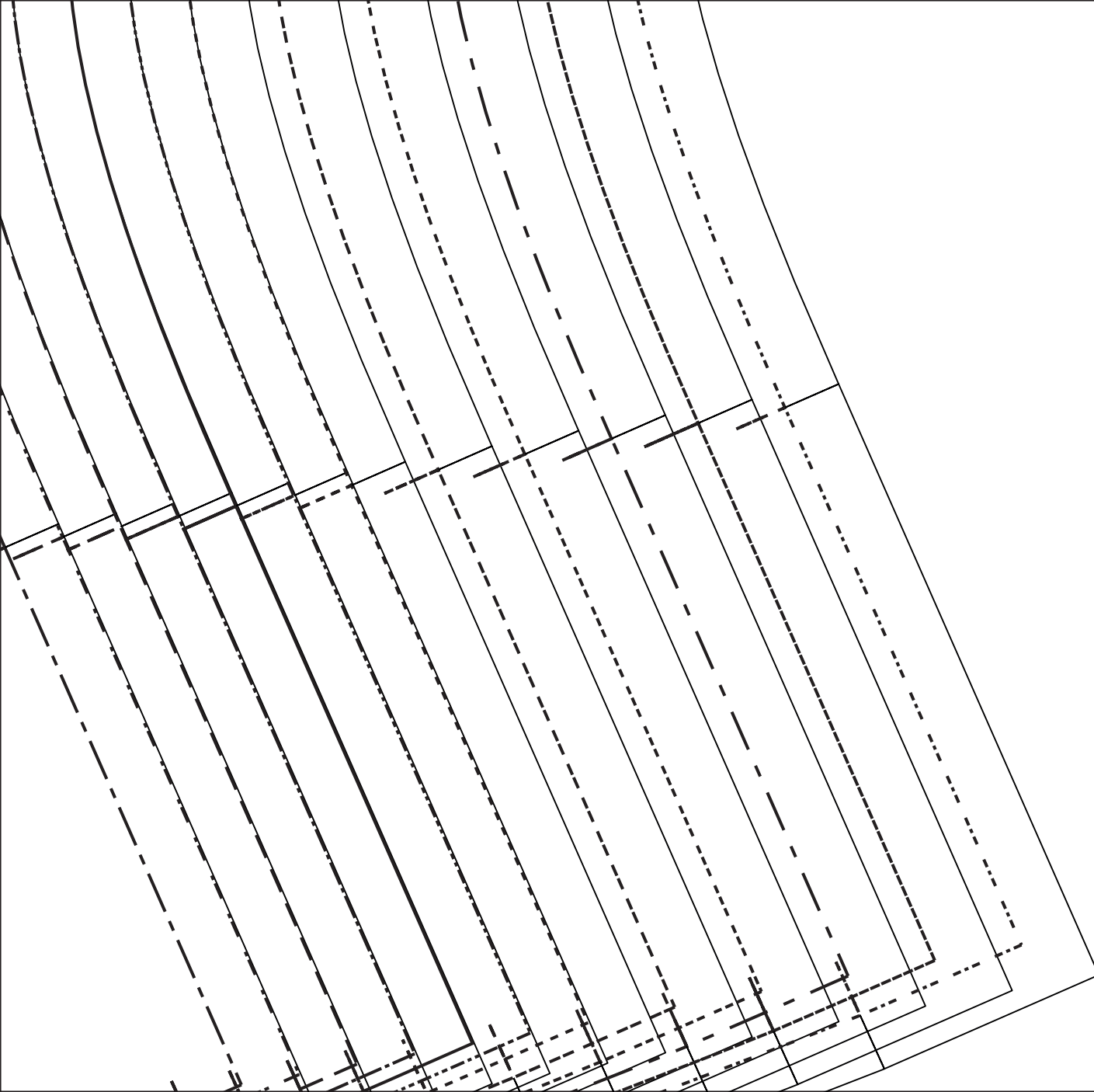

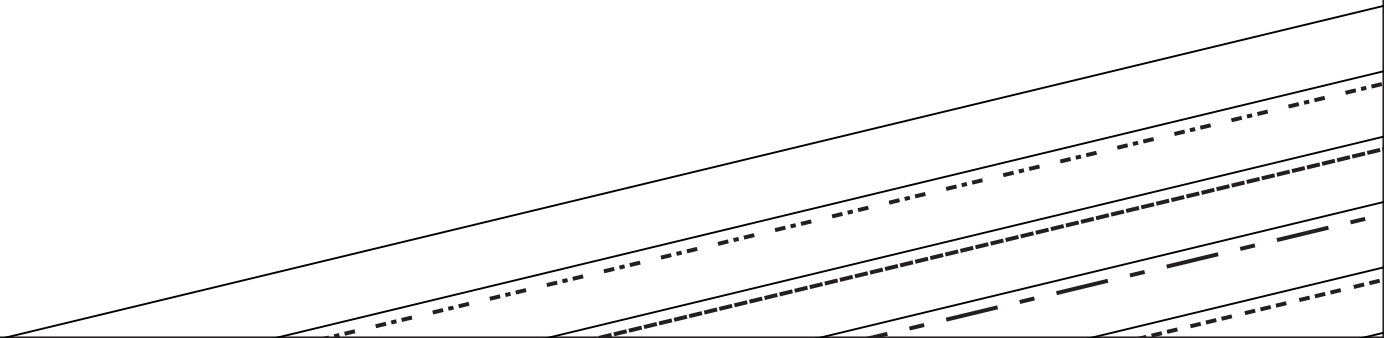
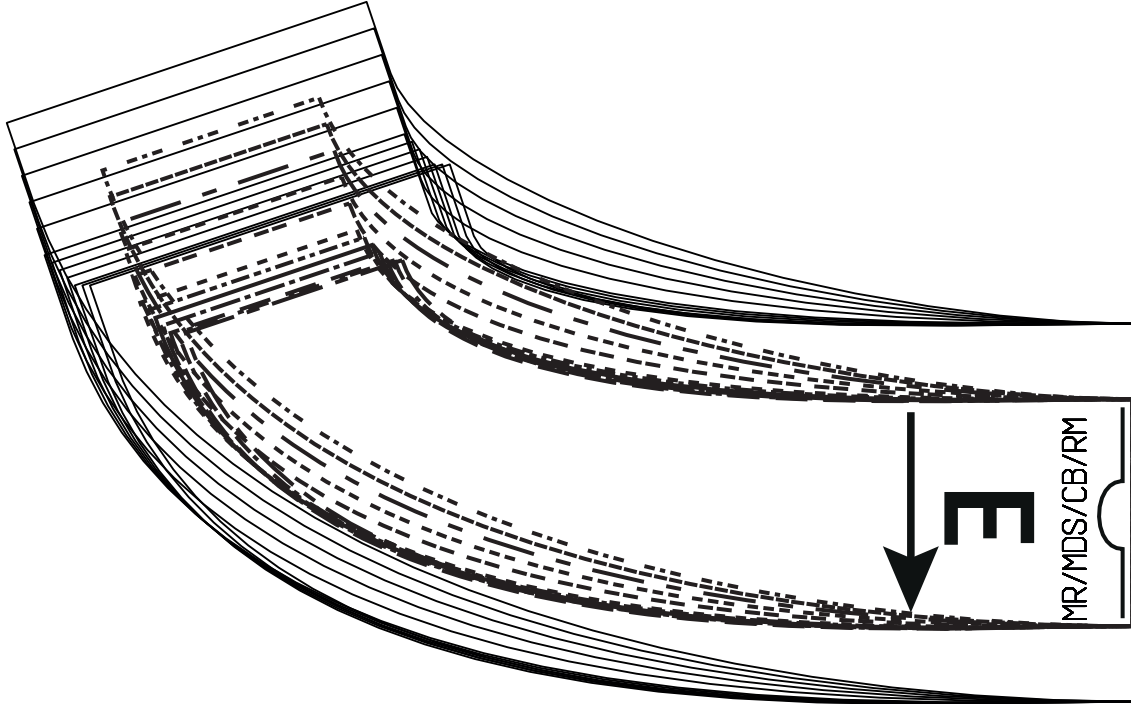

MR/MDS/CB/RM

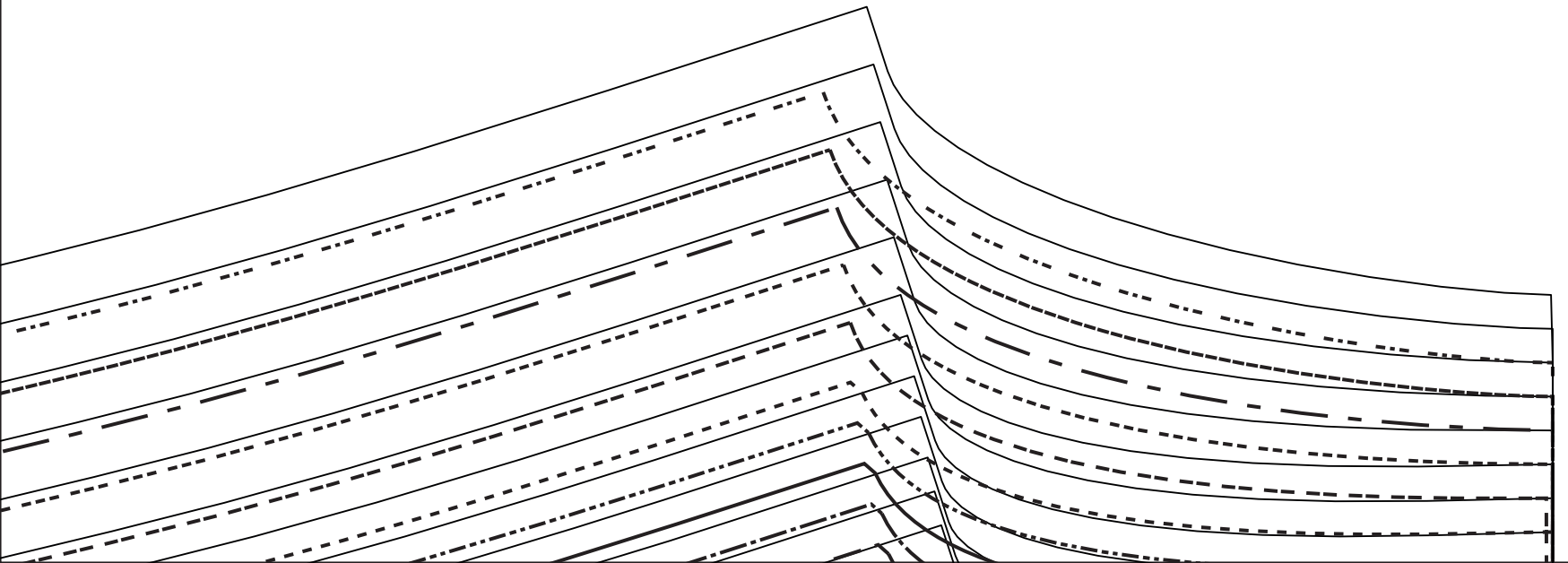

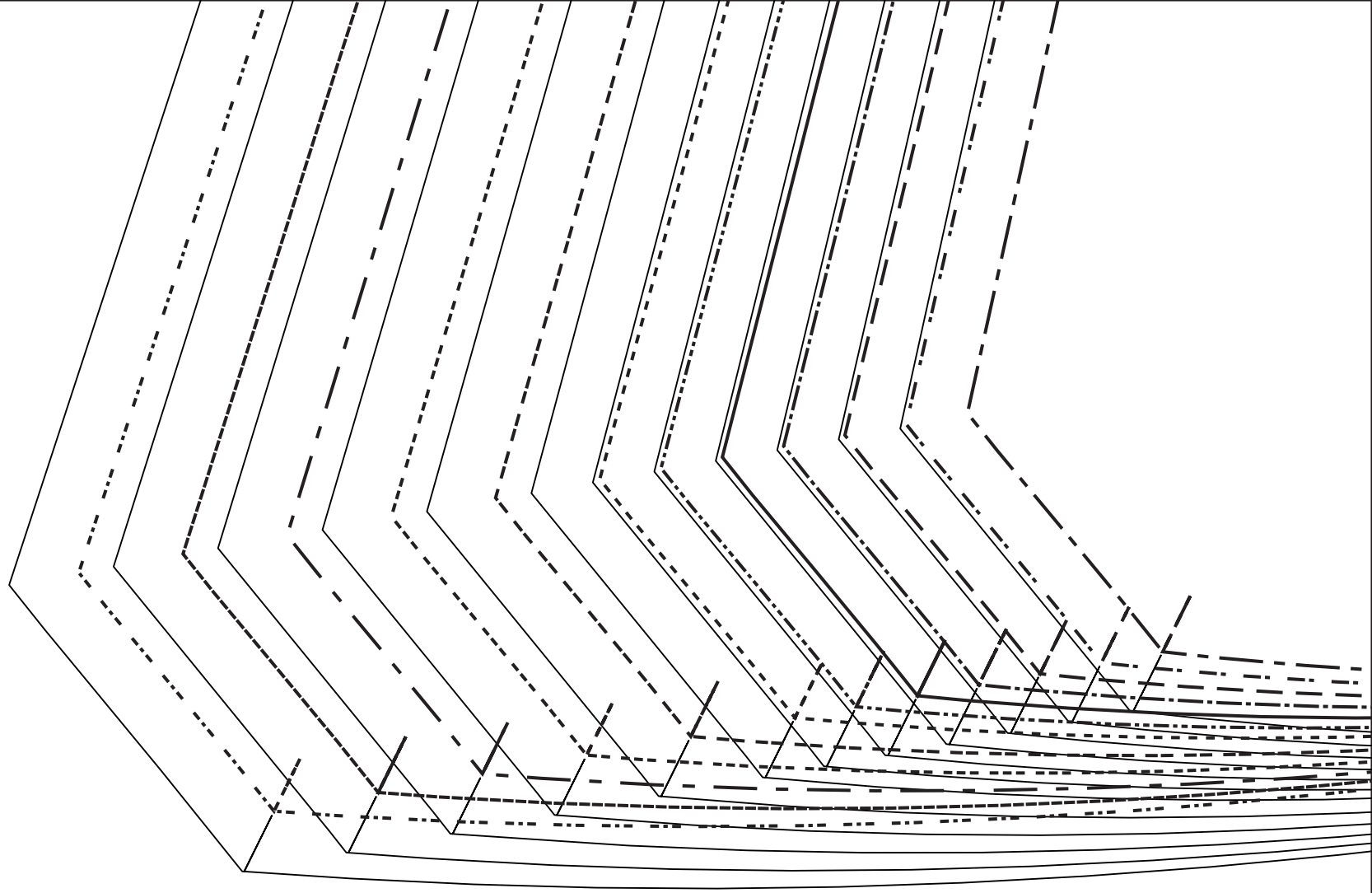

MV/MOV/CF/NM

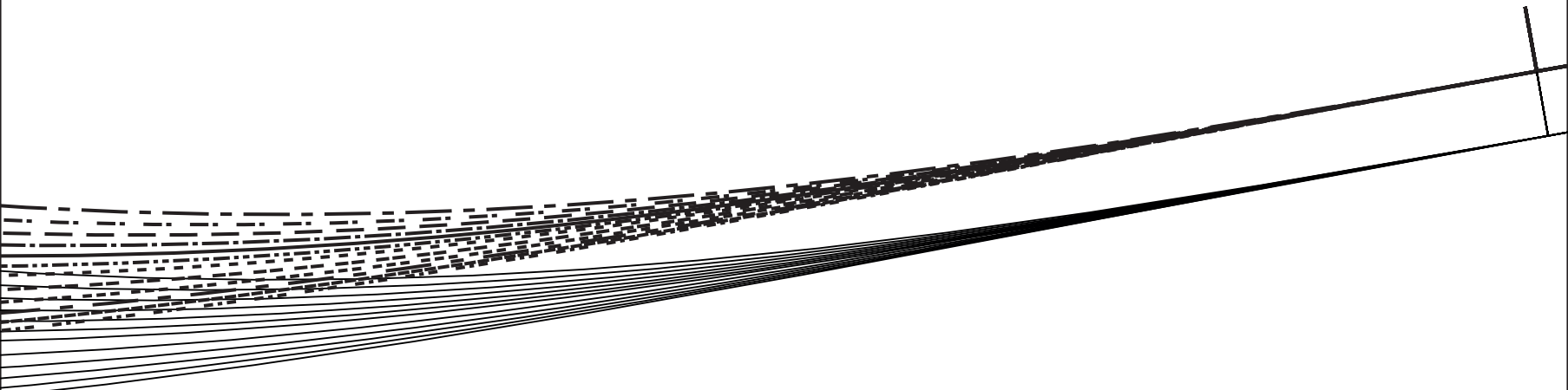

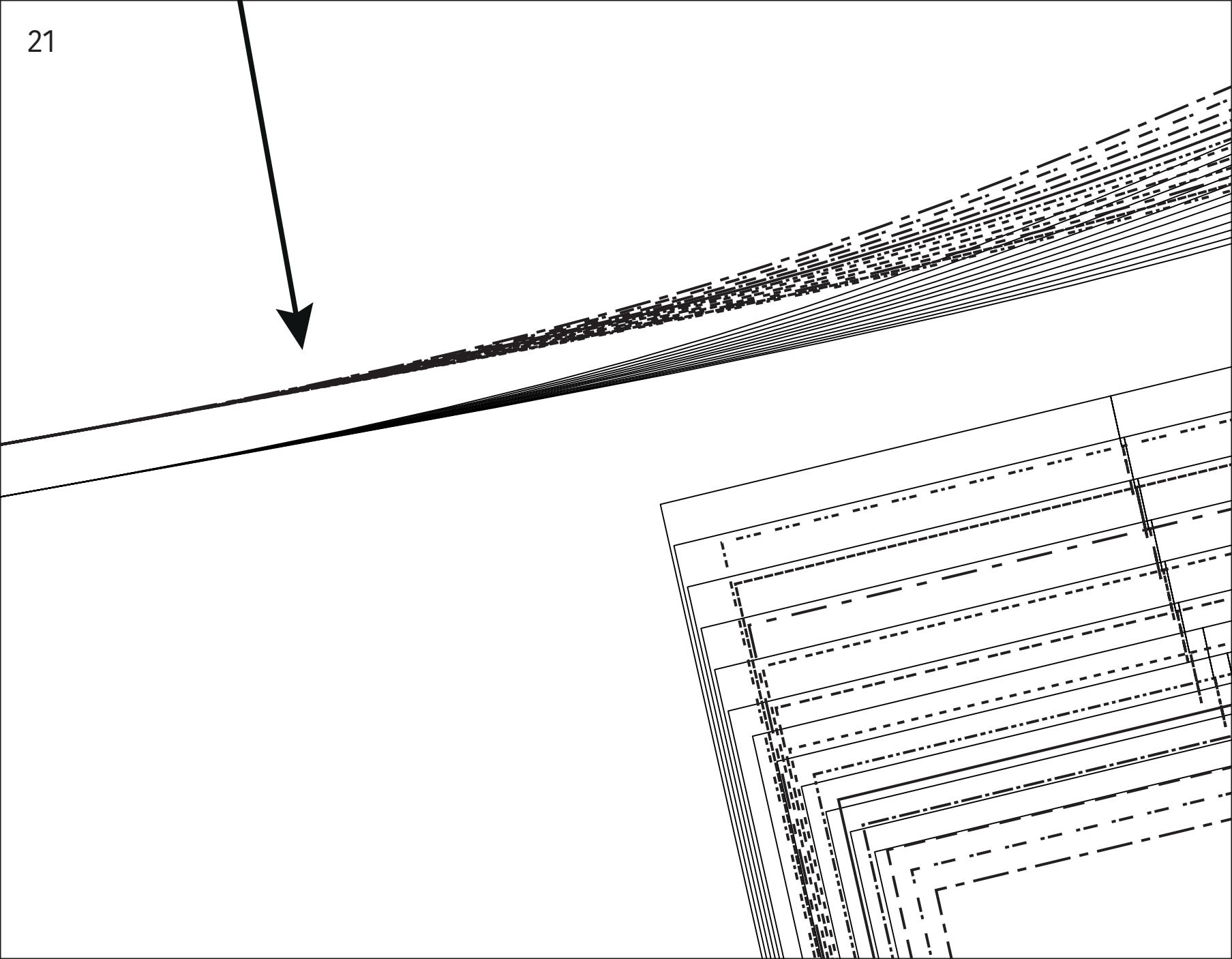

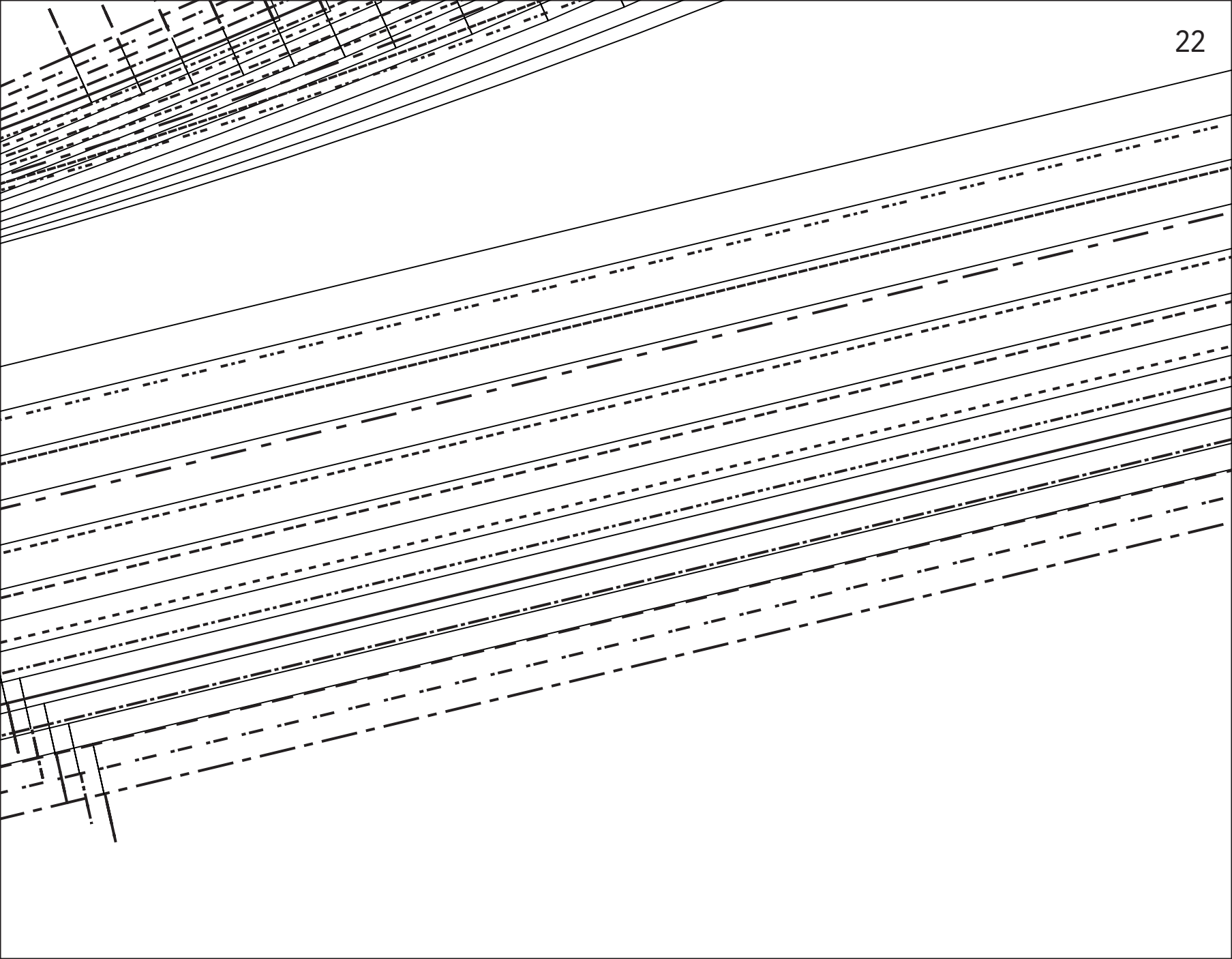

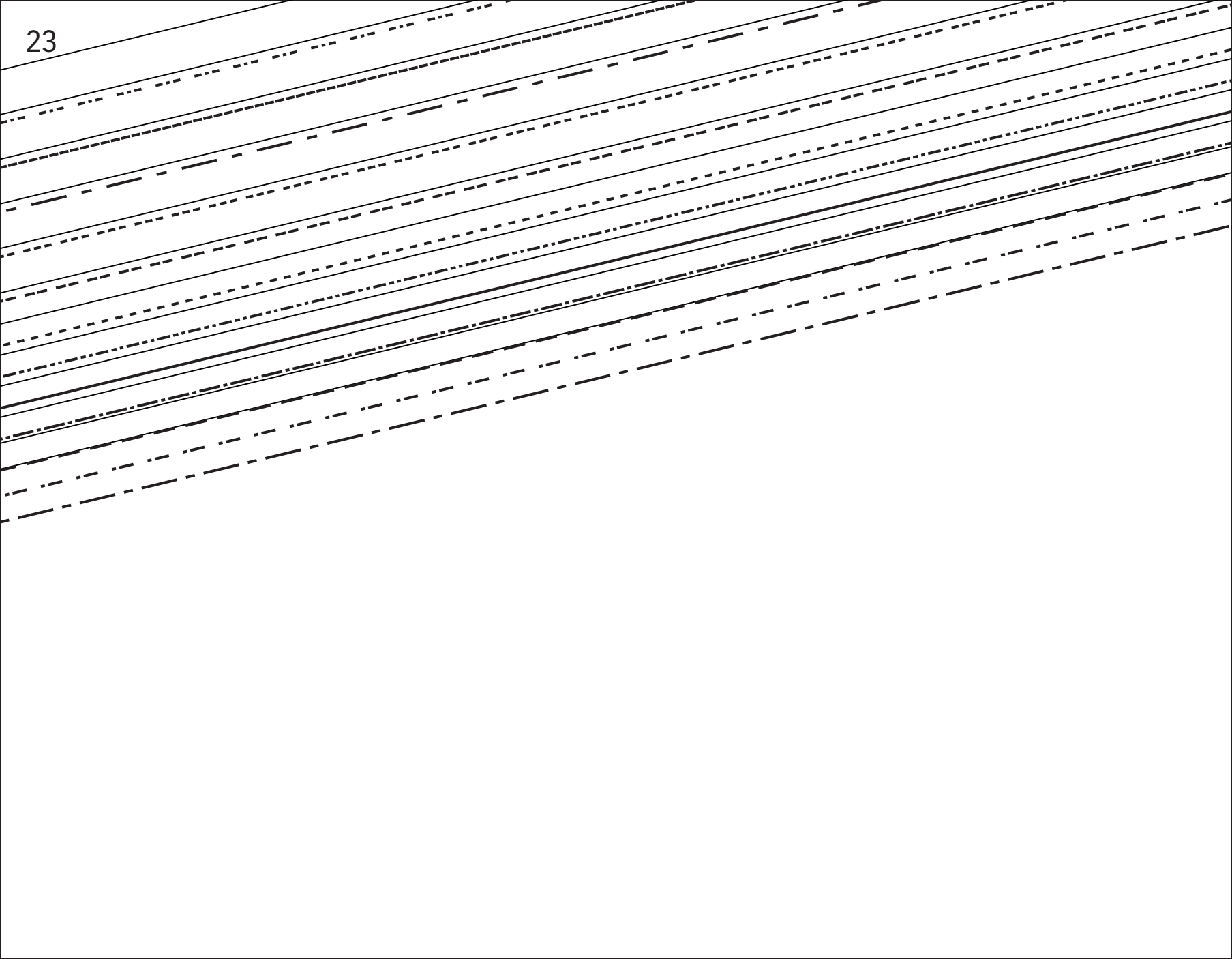

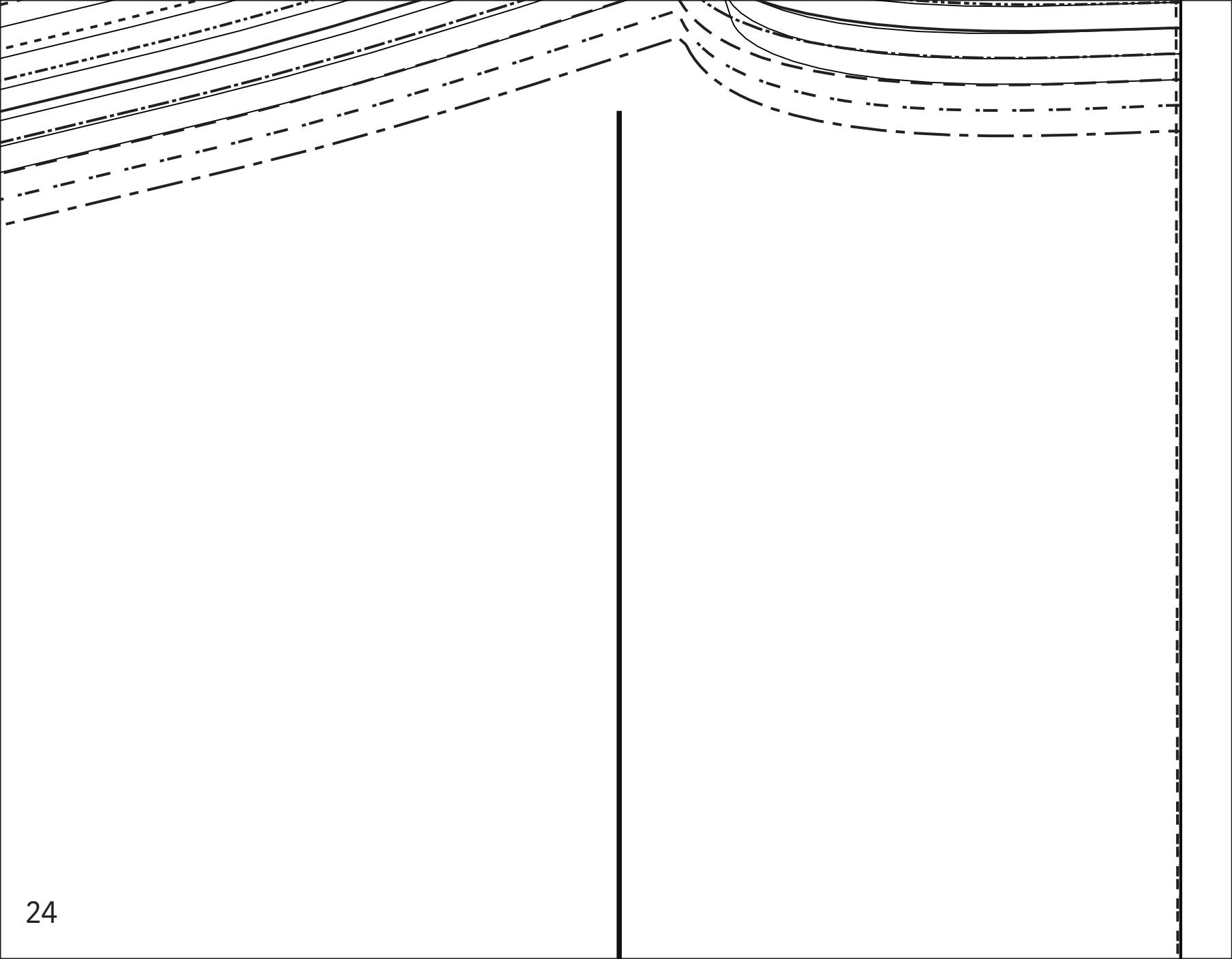

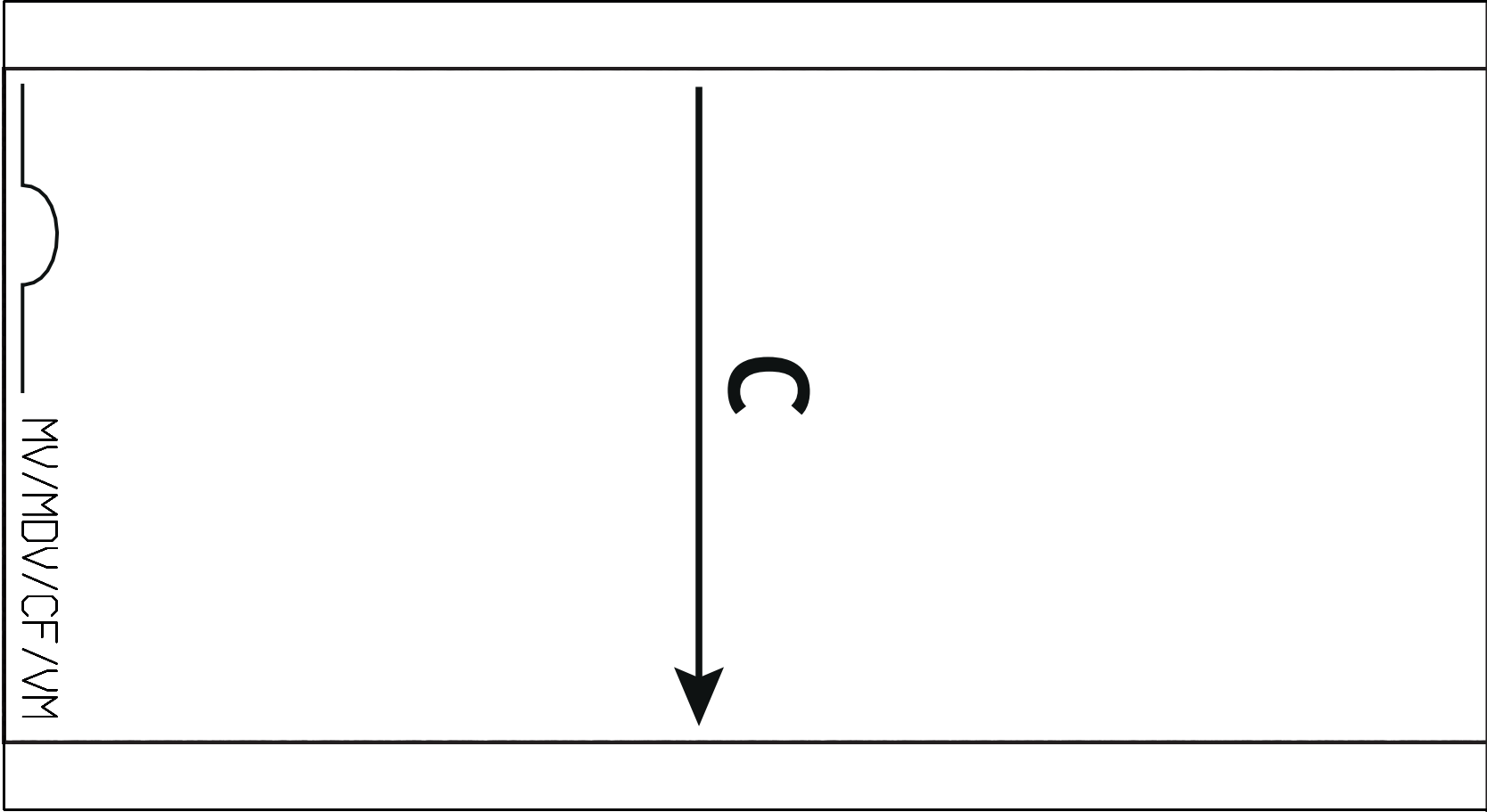

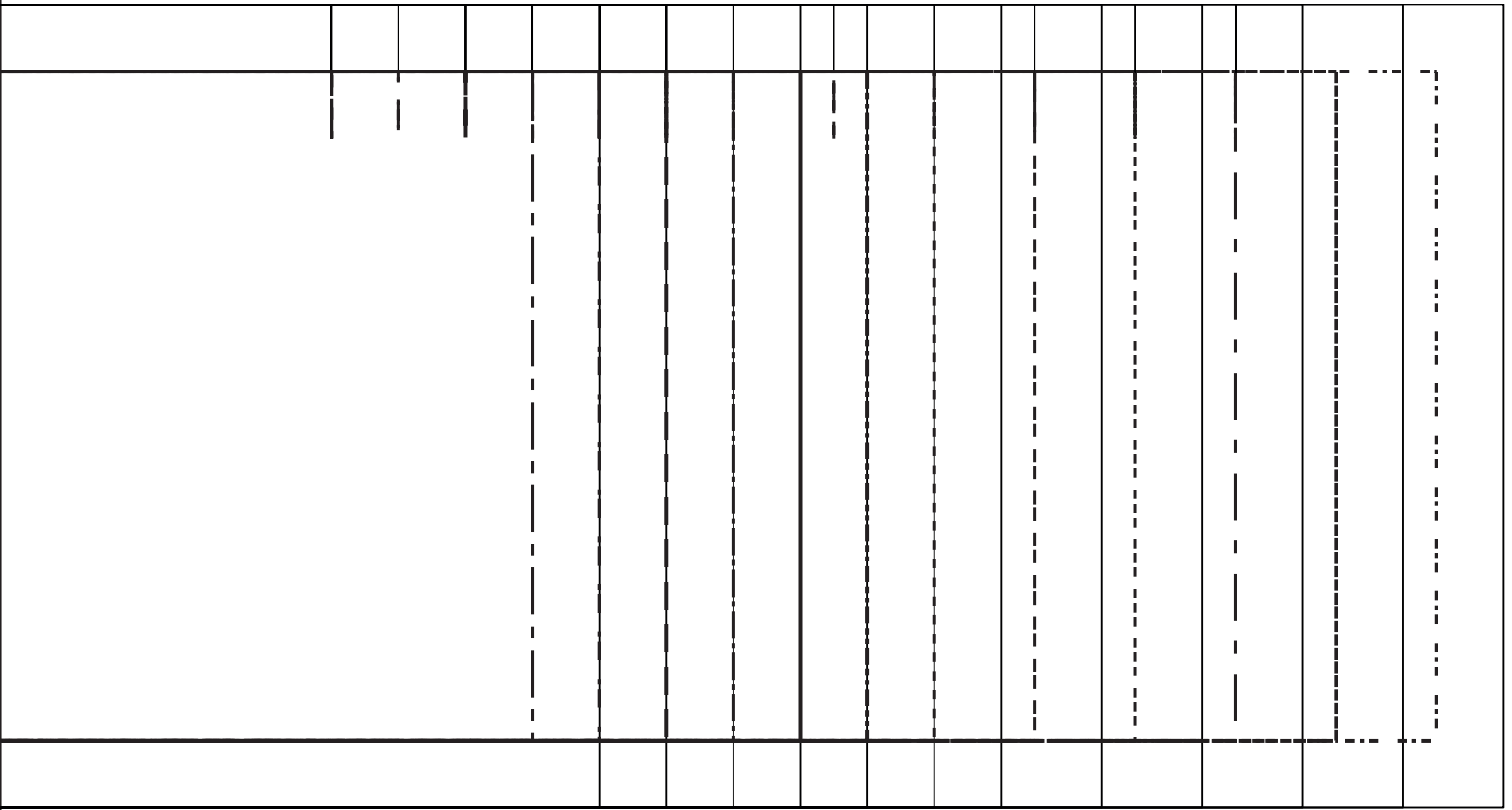

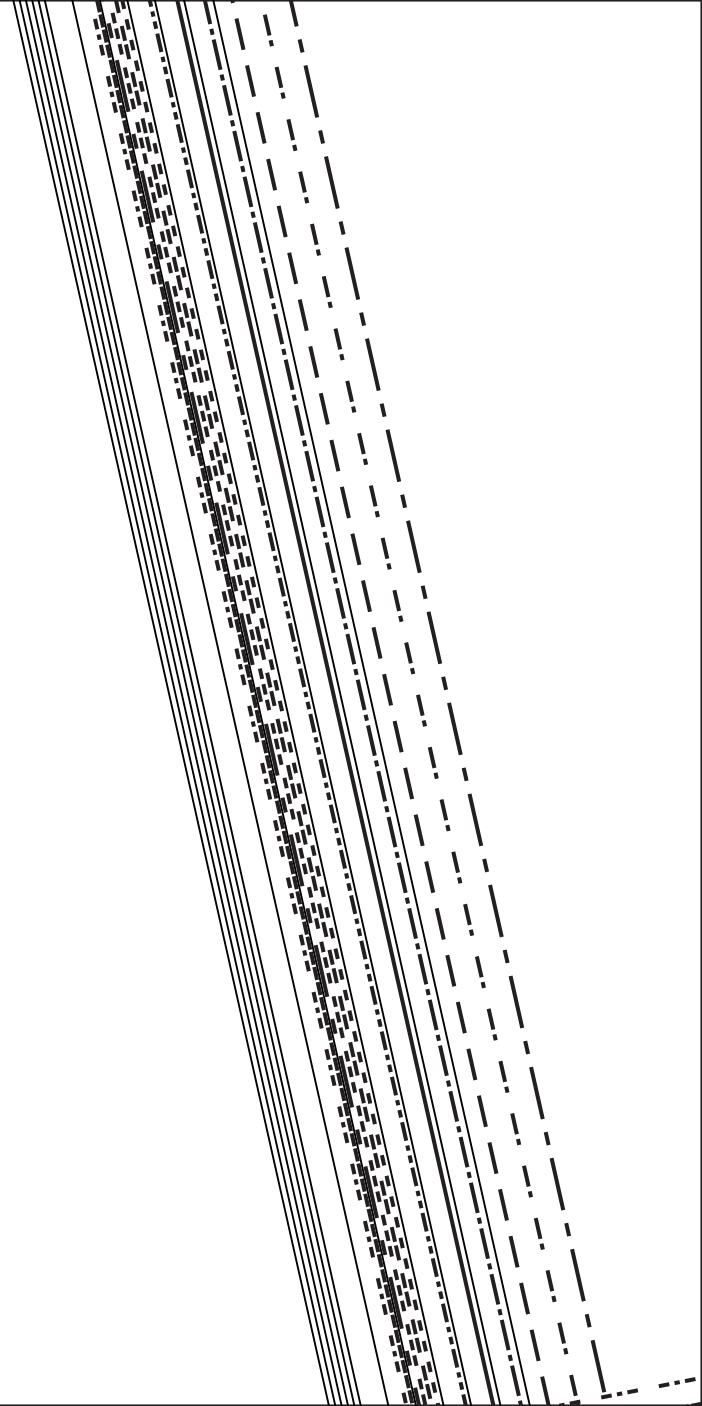

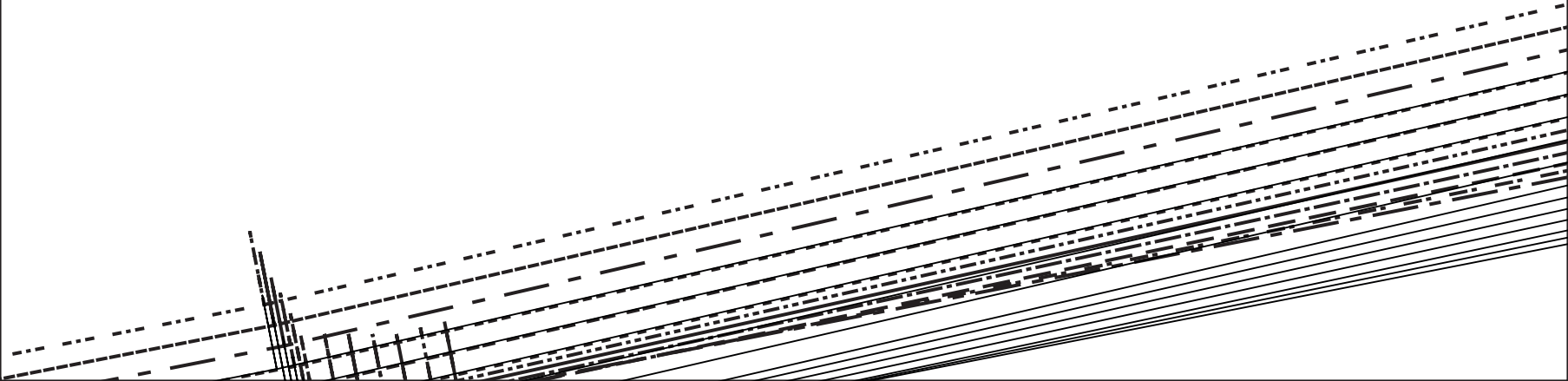

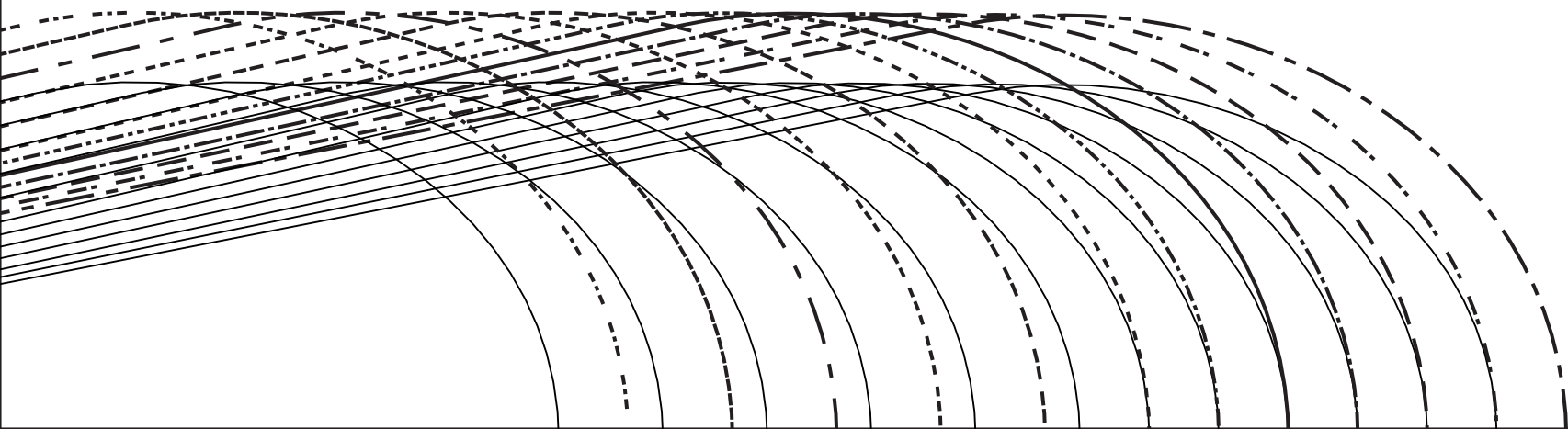

B

MR/MDS/CB/RM



