

Mirl

Trui / Pull / Jumper / Pullover

Maten / Tailles / Sizes / Größen:

.....	XXS
-----	XS
- - - - -	S
· · · · ·	M
- - - - -	L
-----	XL
—————	XXL
.....	XXXL

Patroondelen / Pièces du patron /
Pattern pieces / Schnittteile:

- A** voorpand / devant / front panel /
Vorderteil
- B** rugpand / dos / back panel /
Rückenteil
- C** mouw / manche / sleeve / Ärmel
- D** kraag / col / collar / Kragen
- E** zoomboord / bord ourlet / hem /
Saumbund
- F** mouwboord / bord manchette /
cuff / Ärmelbündchen.

Patroonschema / Schéma du Patron / Pattern Diagram /
Übersichtsplan zum Zusammenkleben

1	2	3	4	5	6
7	8	9	10	11	12
13	14	15	16	17	18
19	20	21	22	23	24
25	26				

Controlevierkant / Carré de controle
/ Test square / Kontrollquadrat

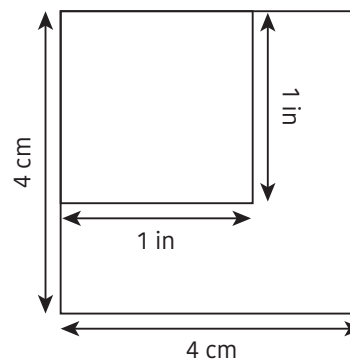

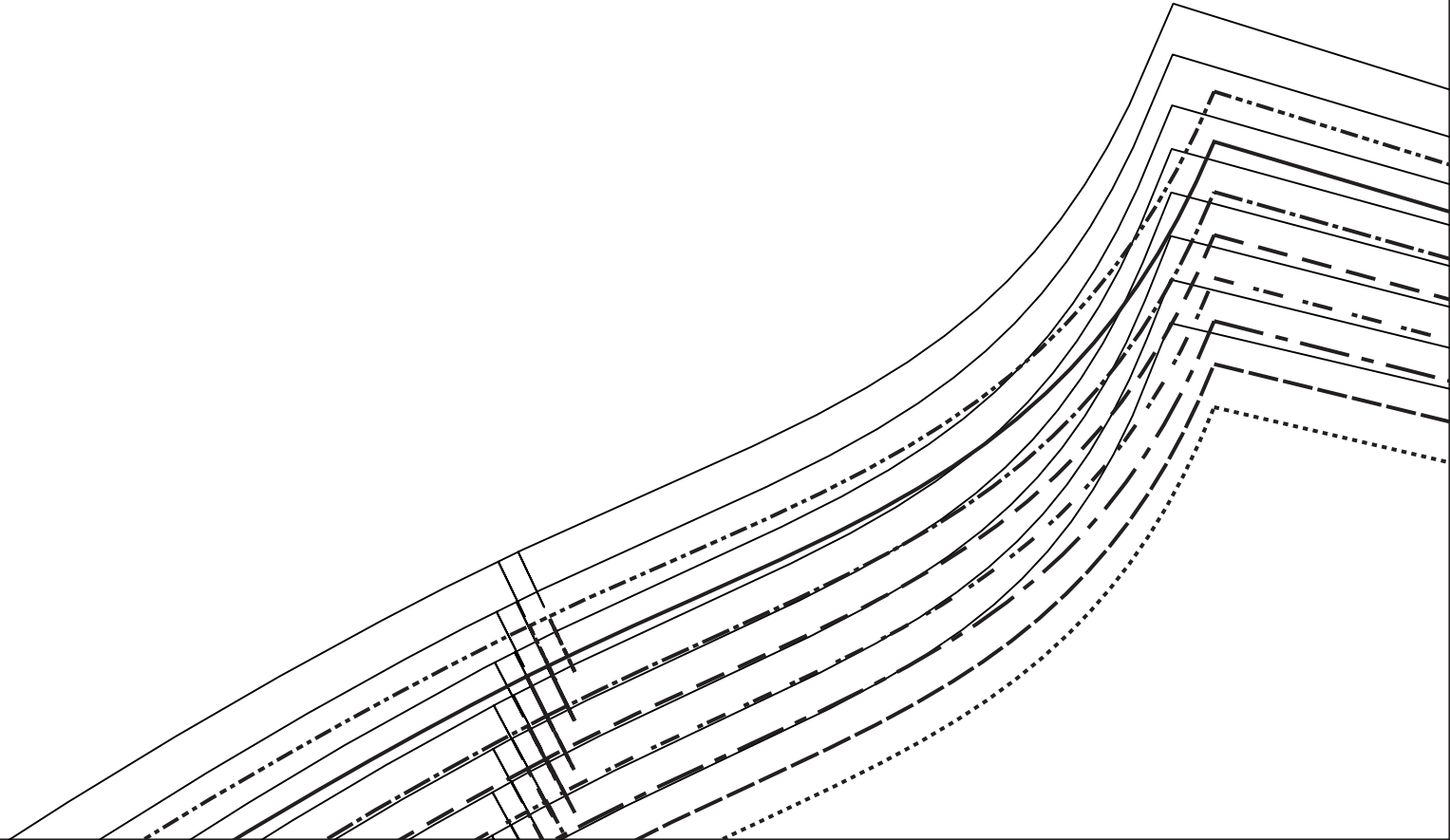

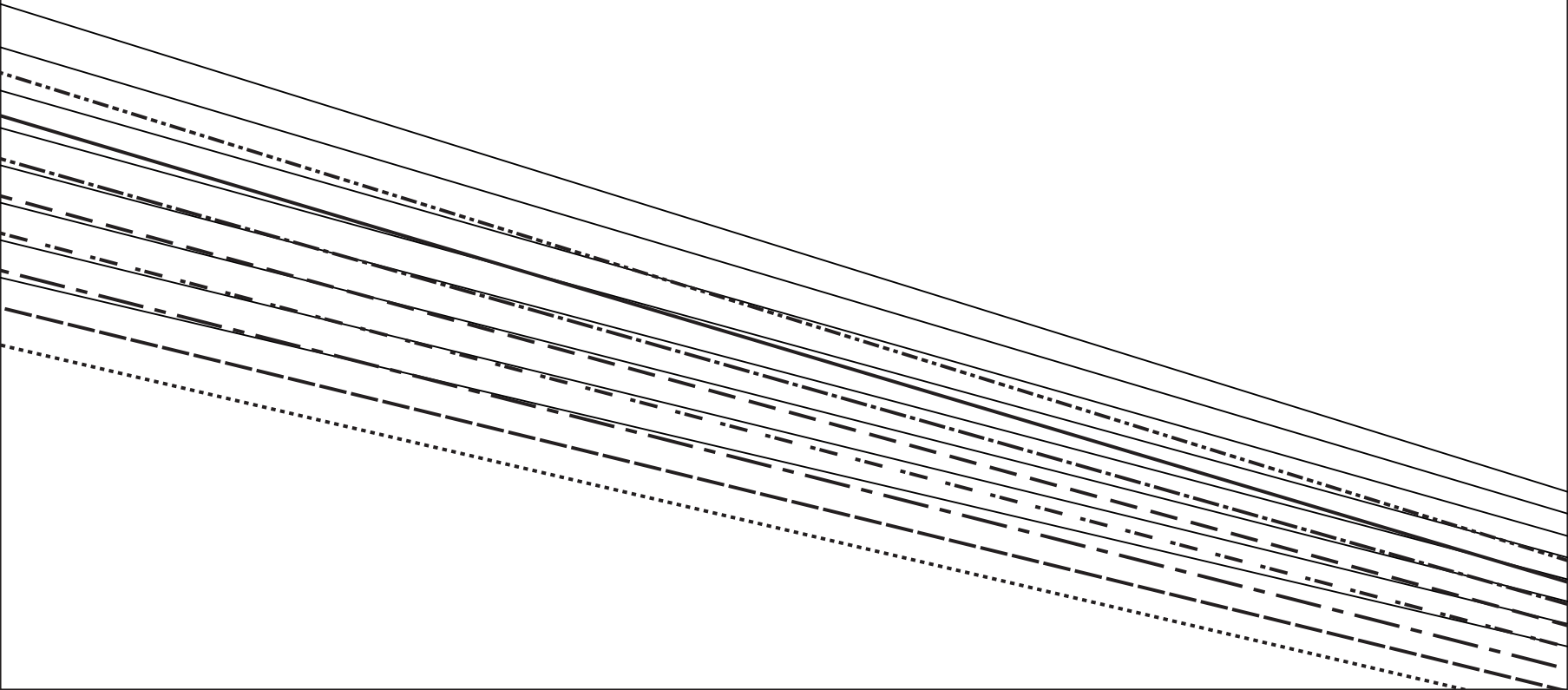

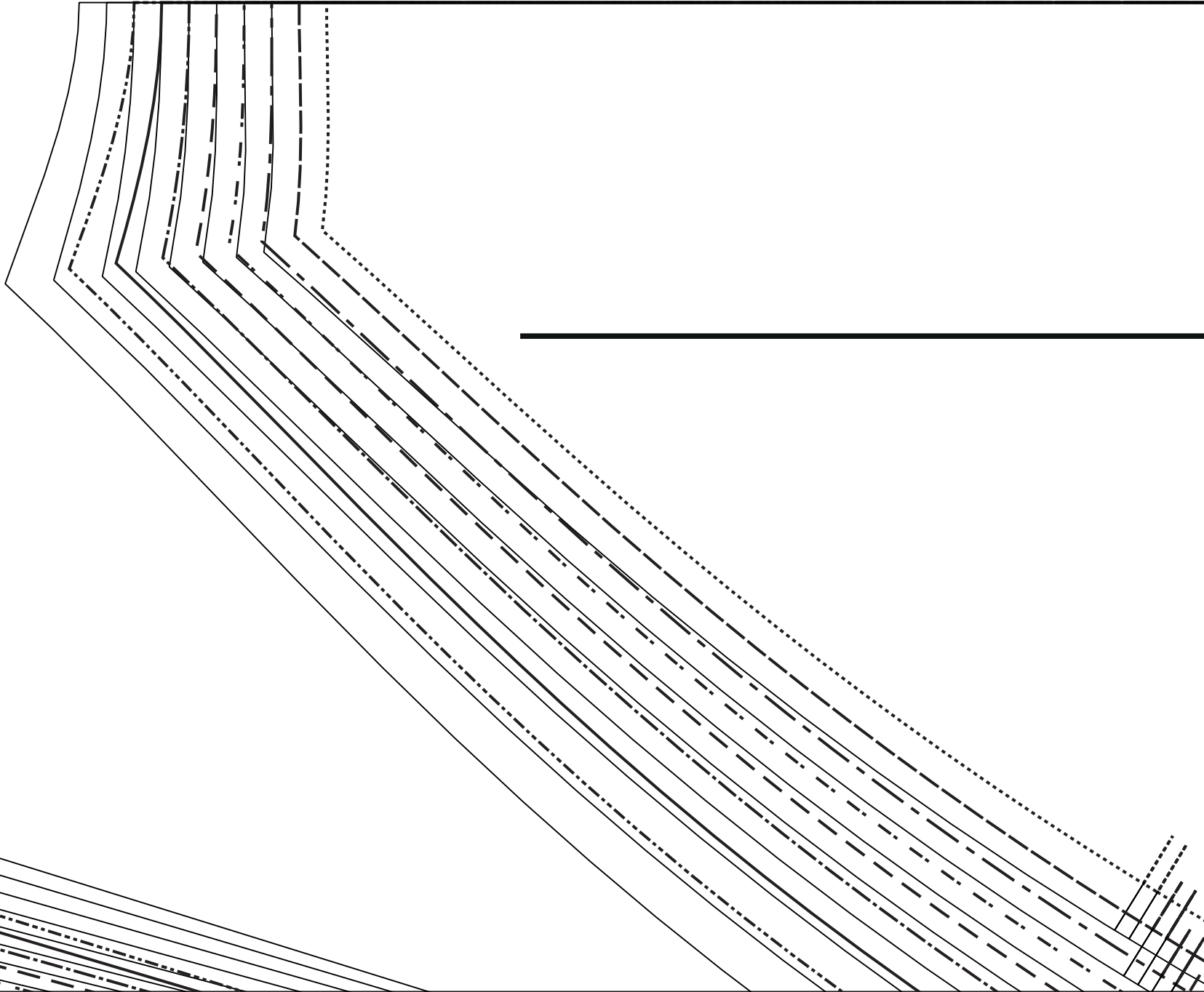



B

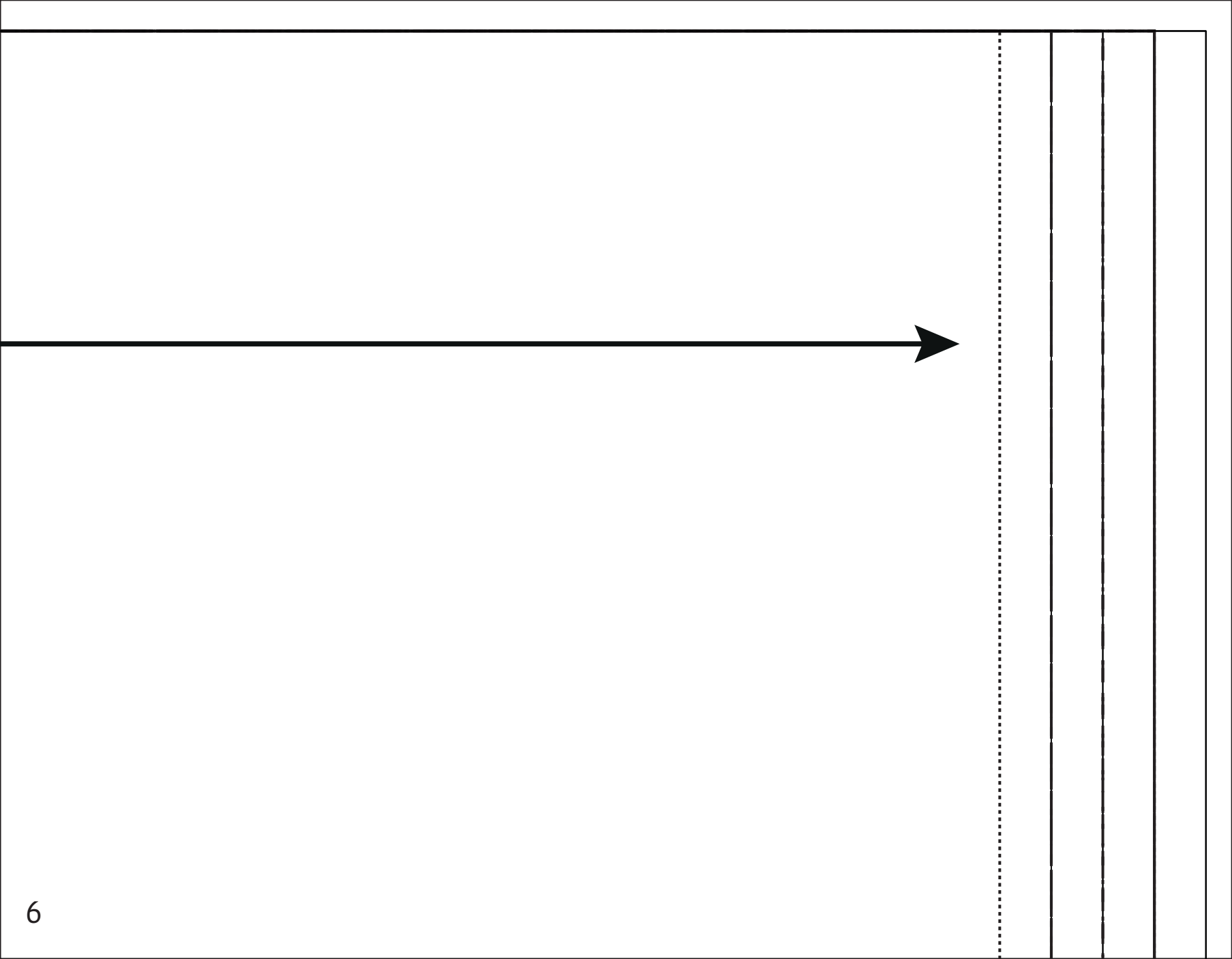

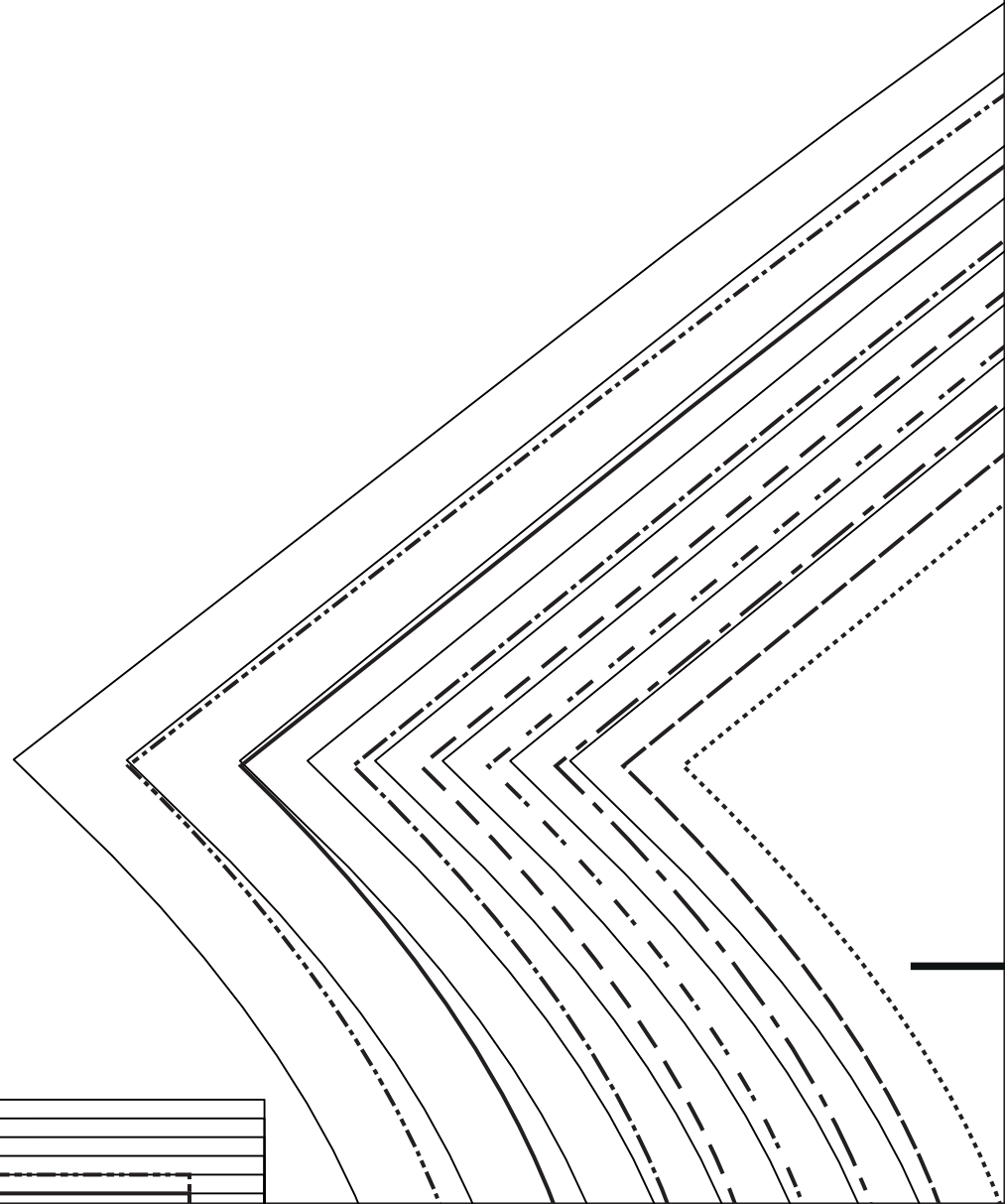

—

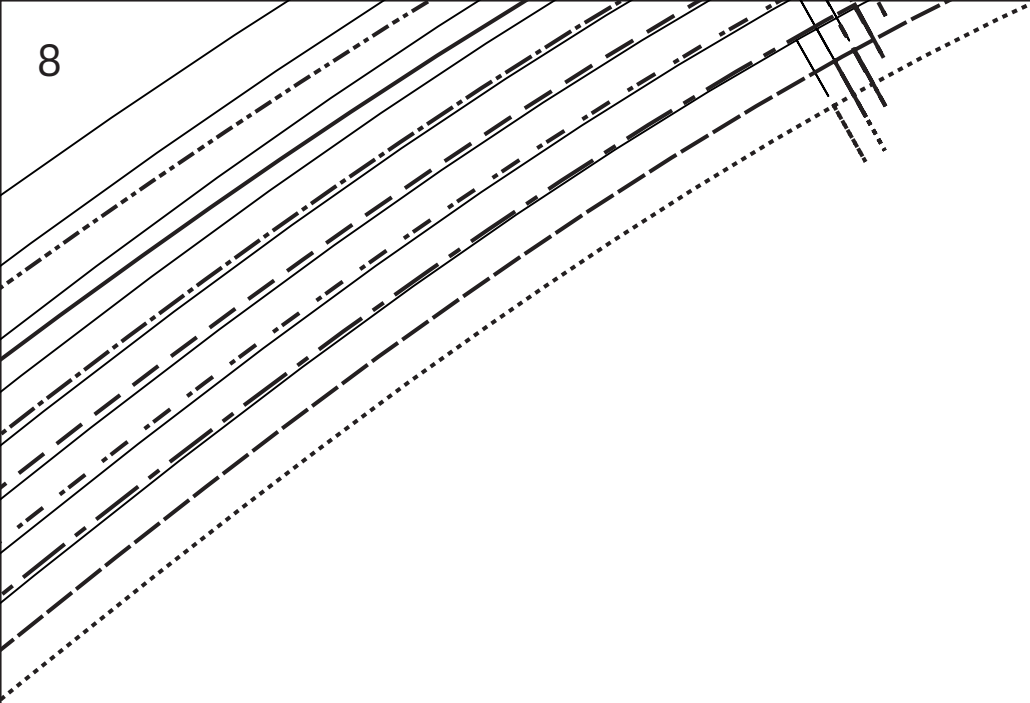

C

10

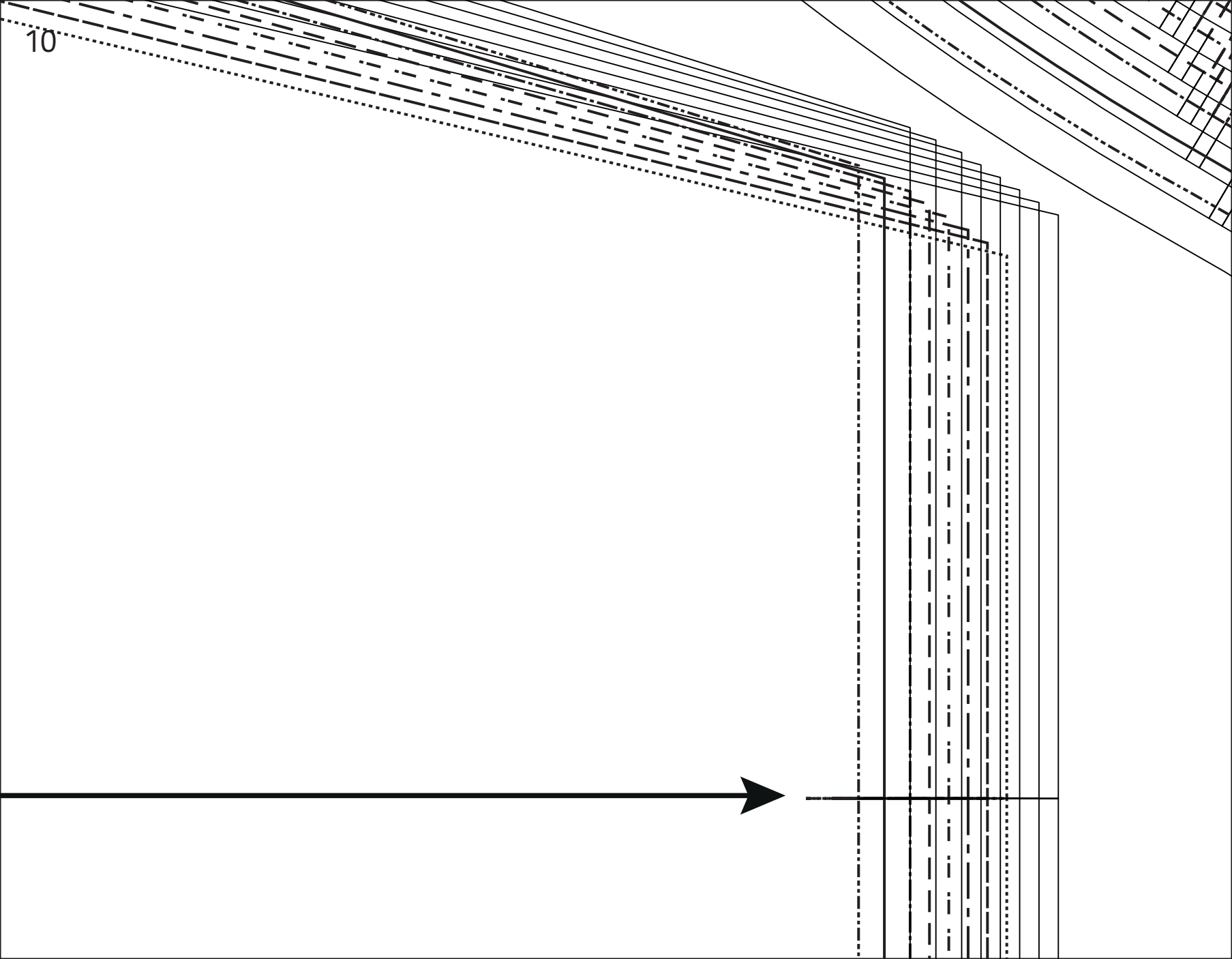

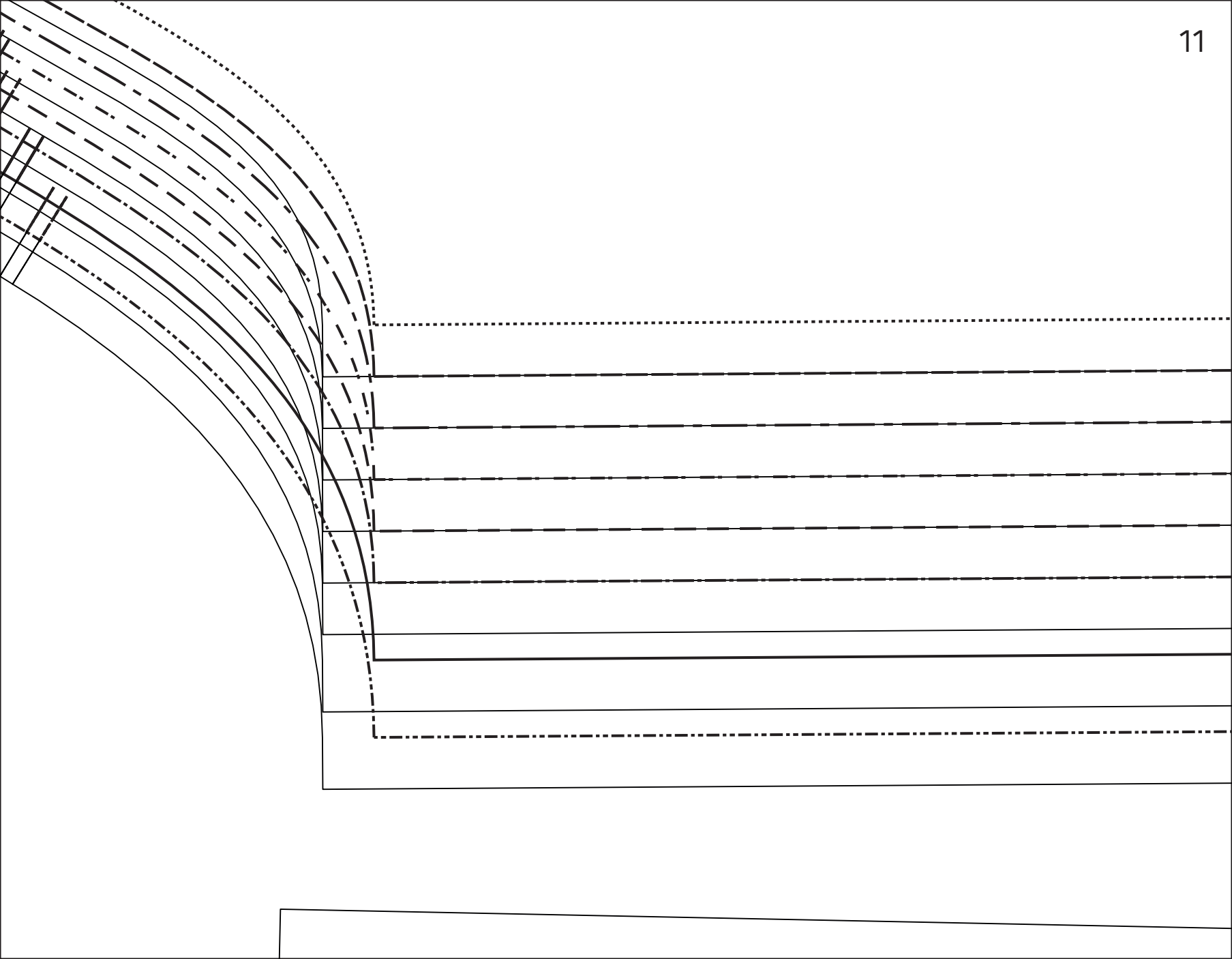

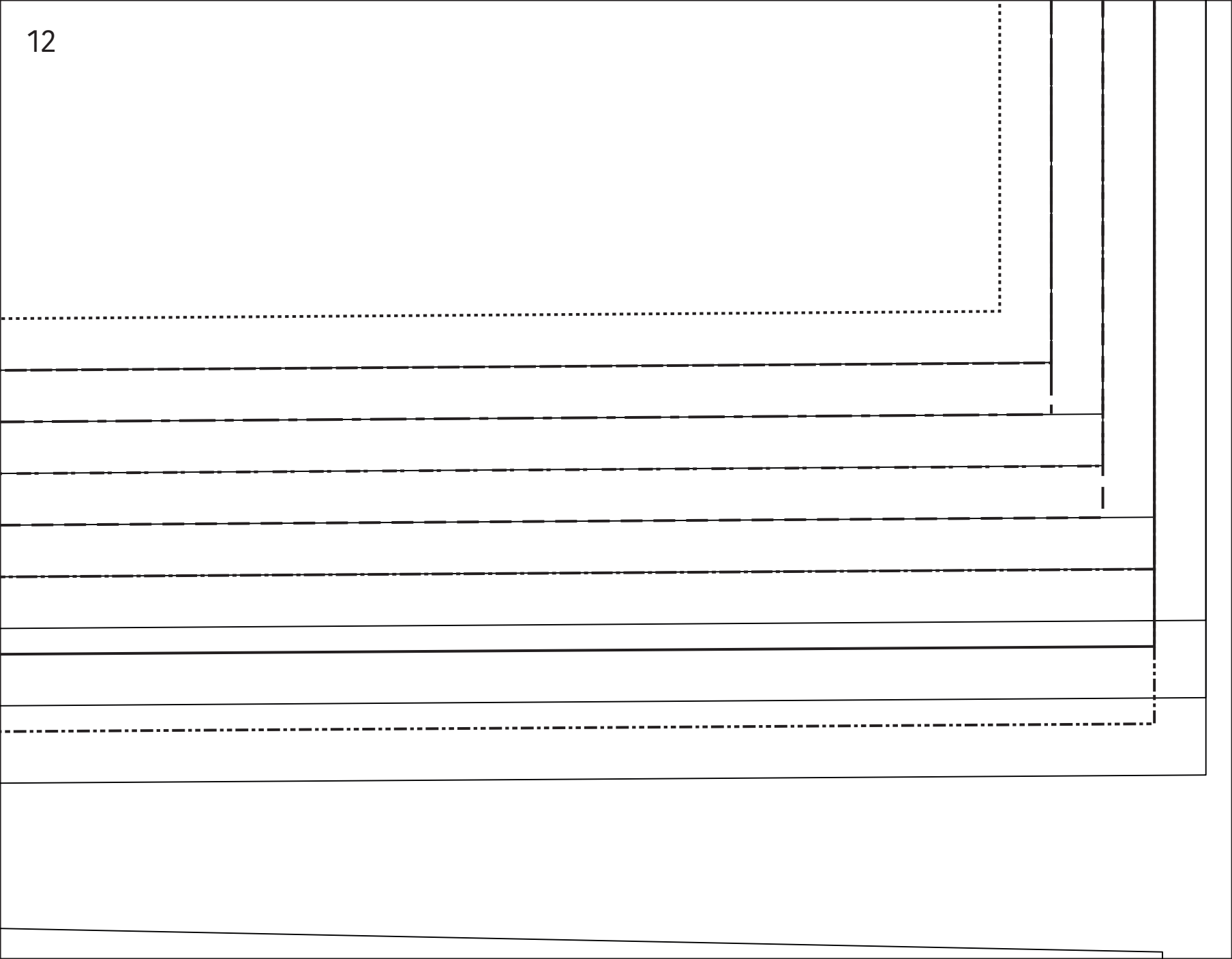

13

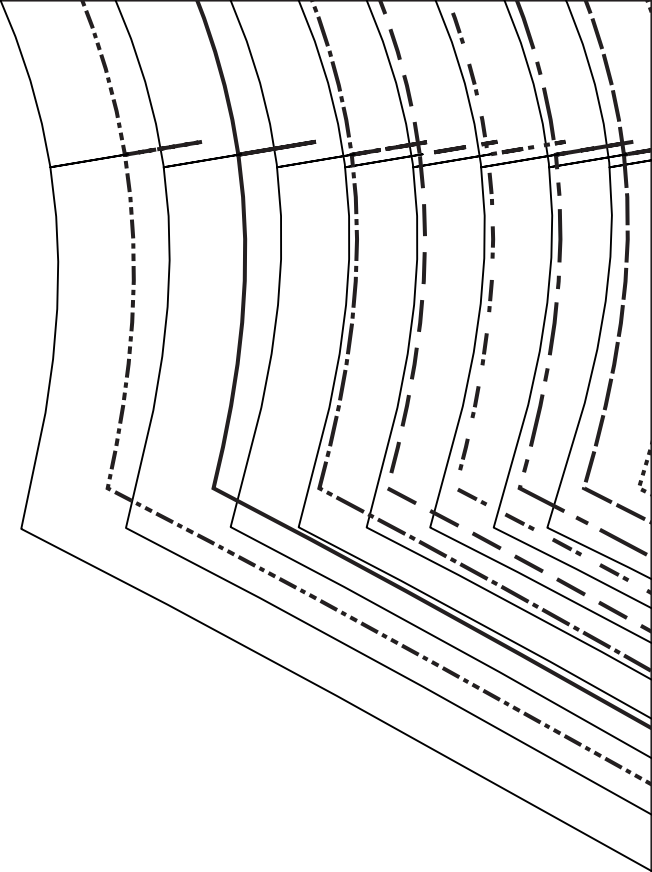
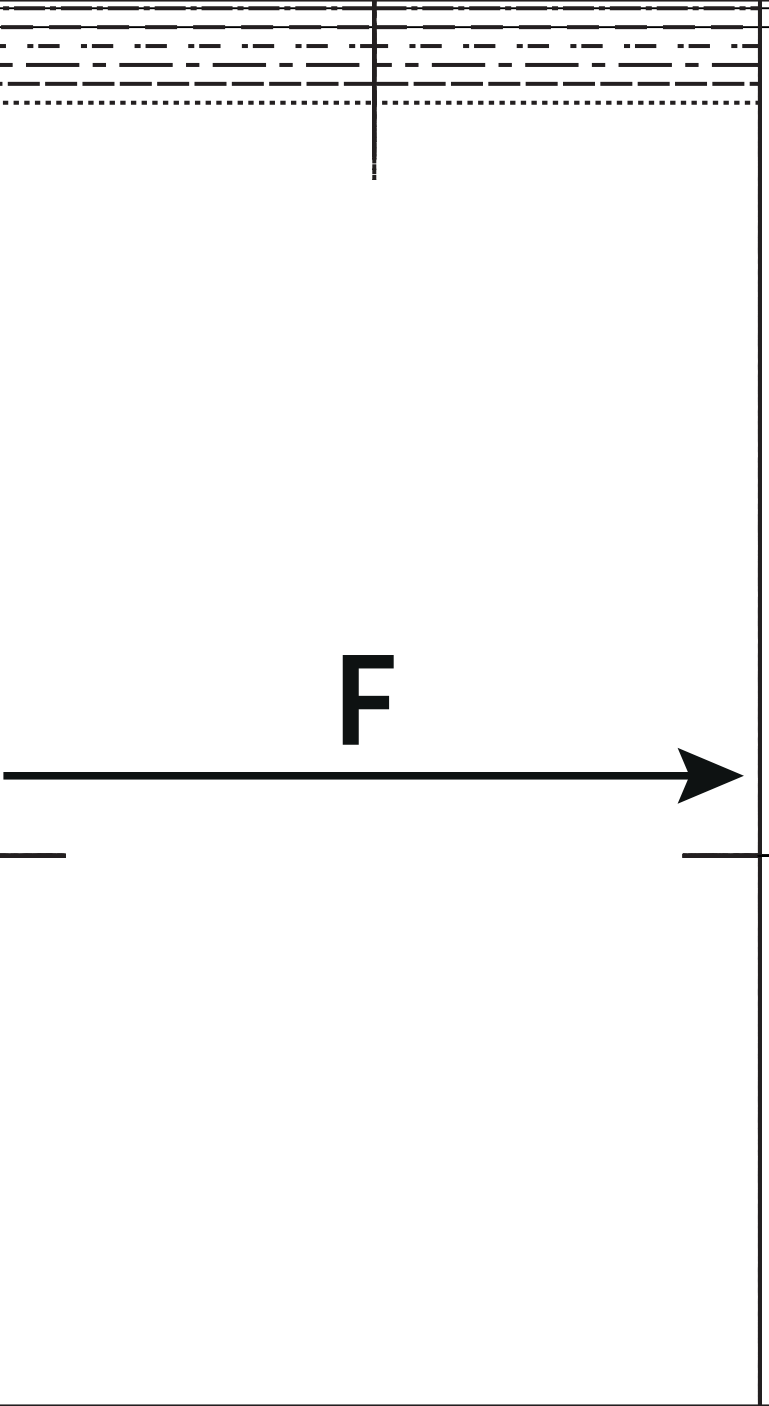

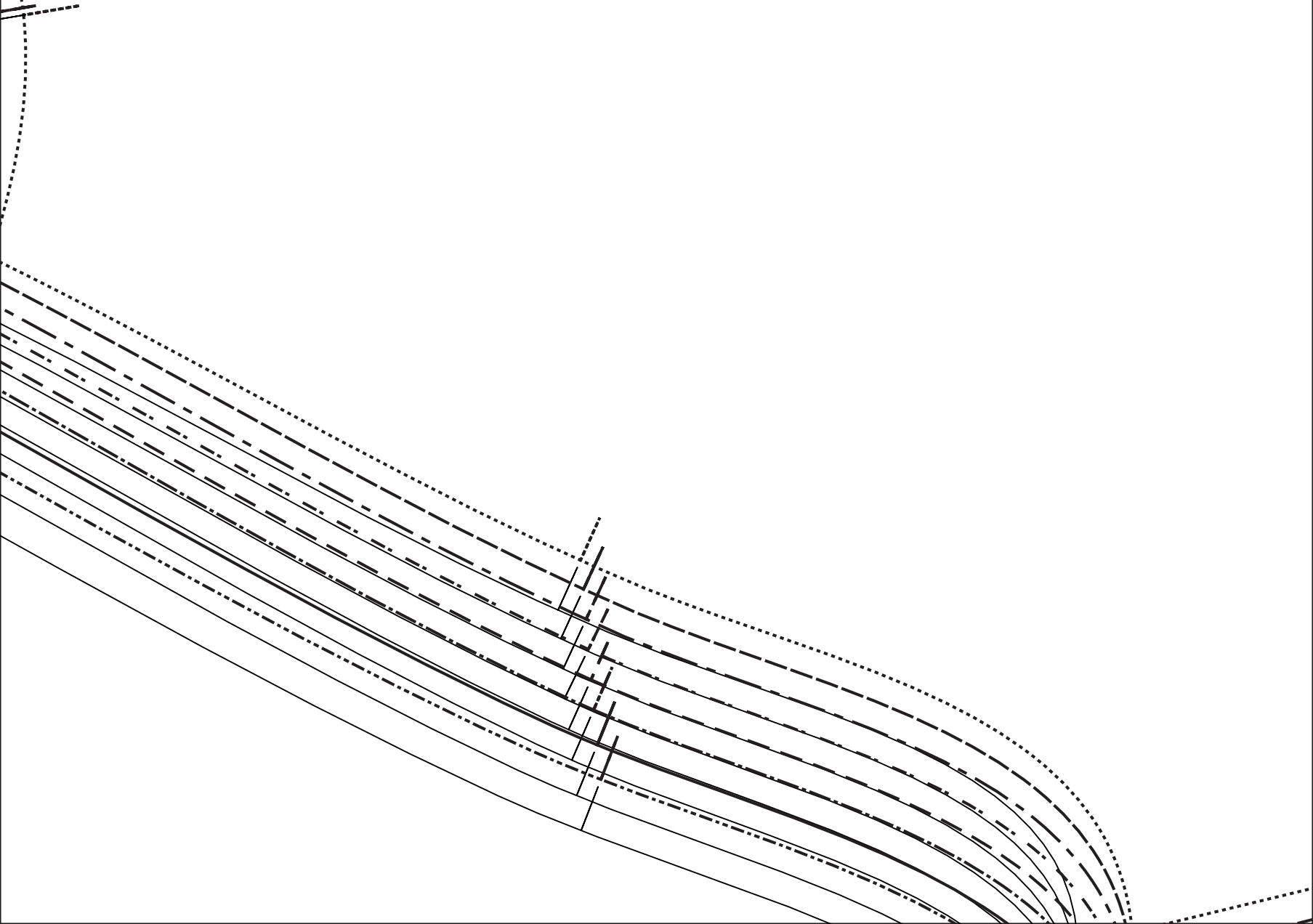

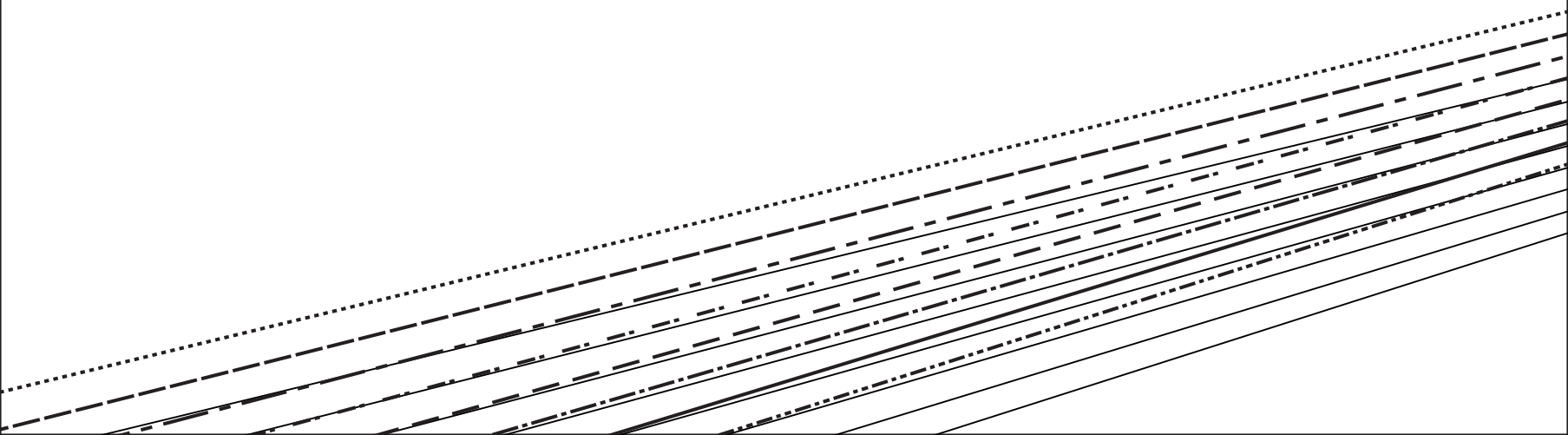

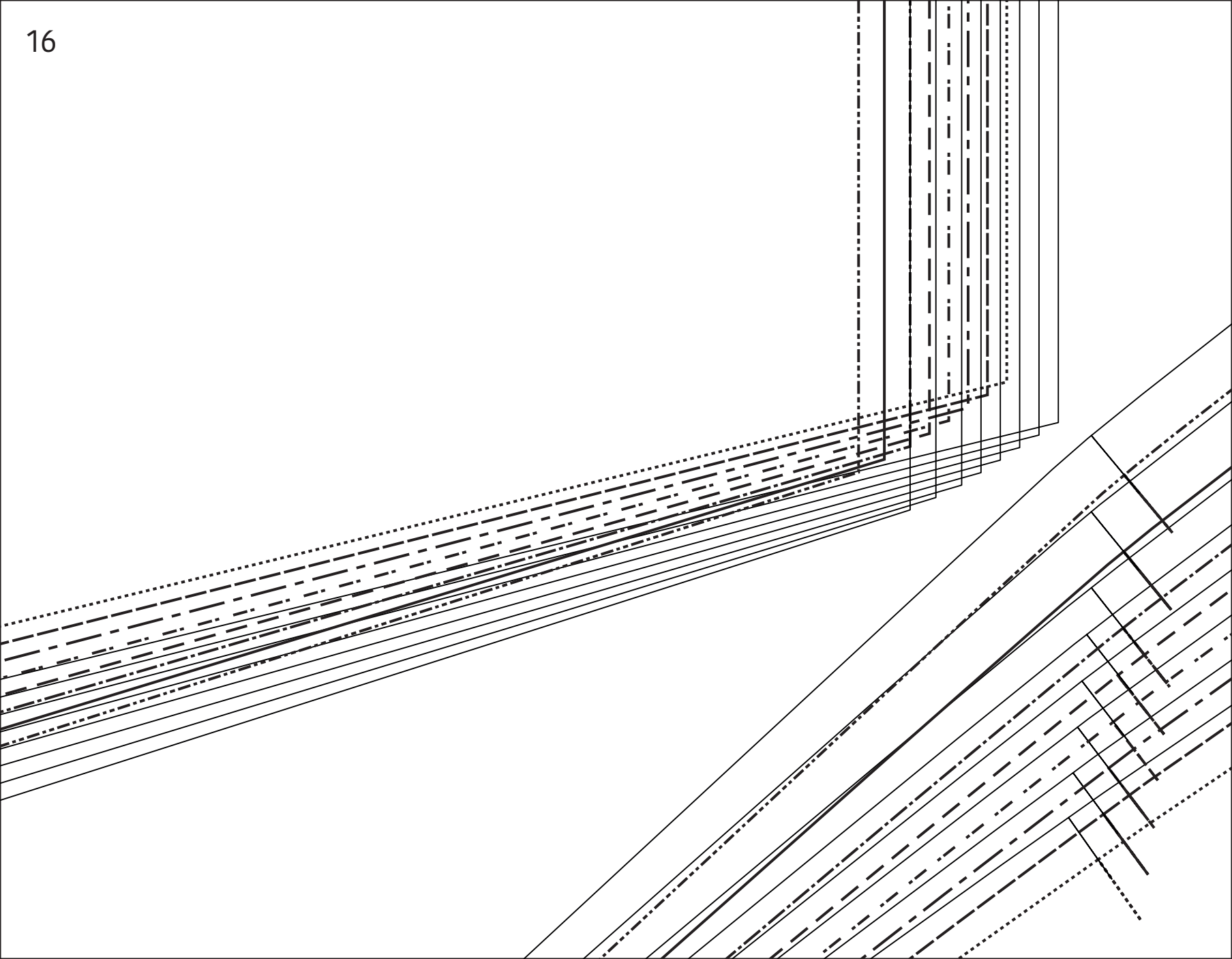

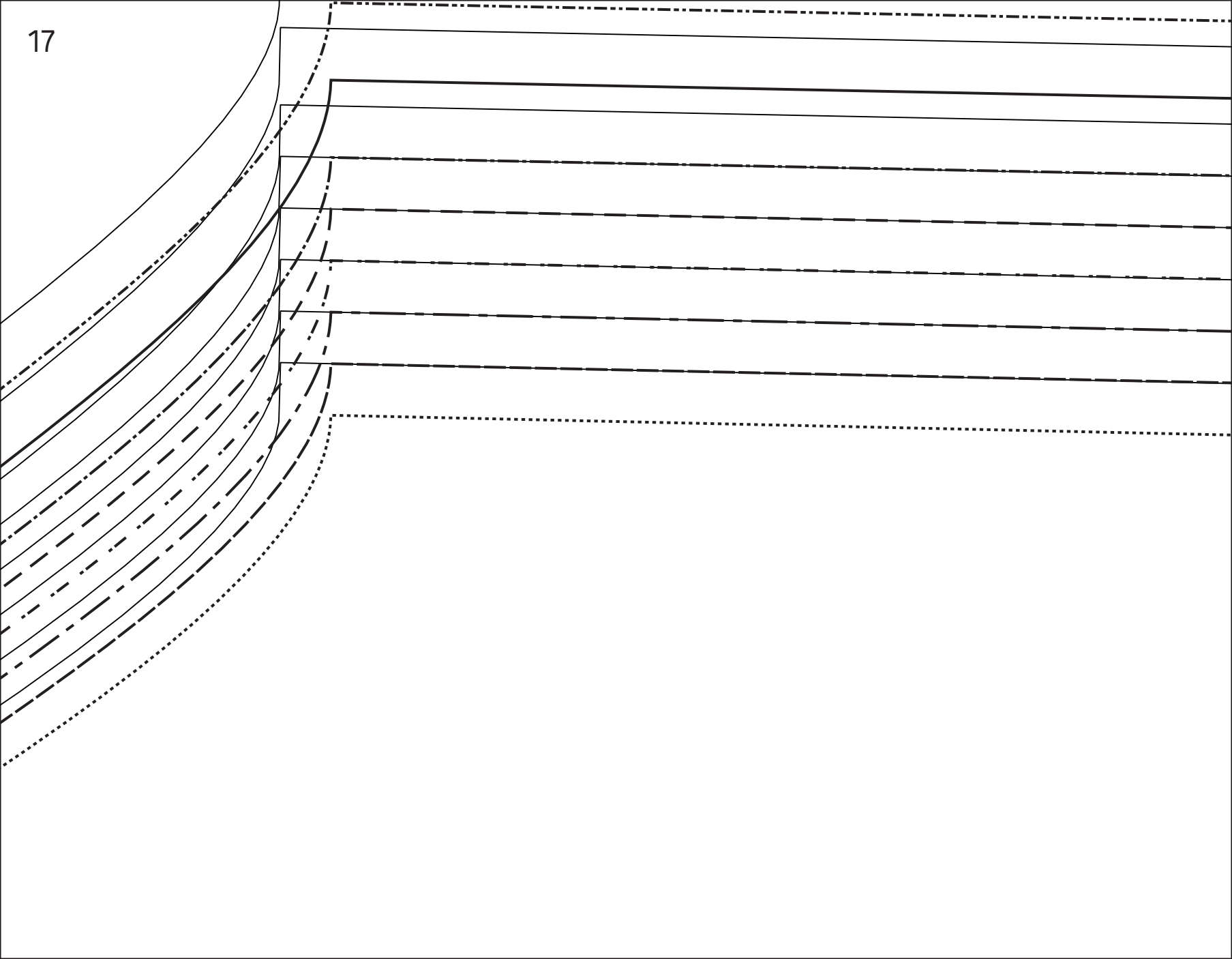

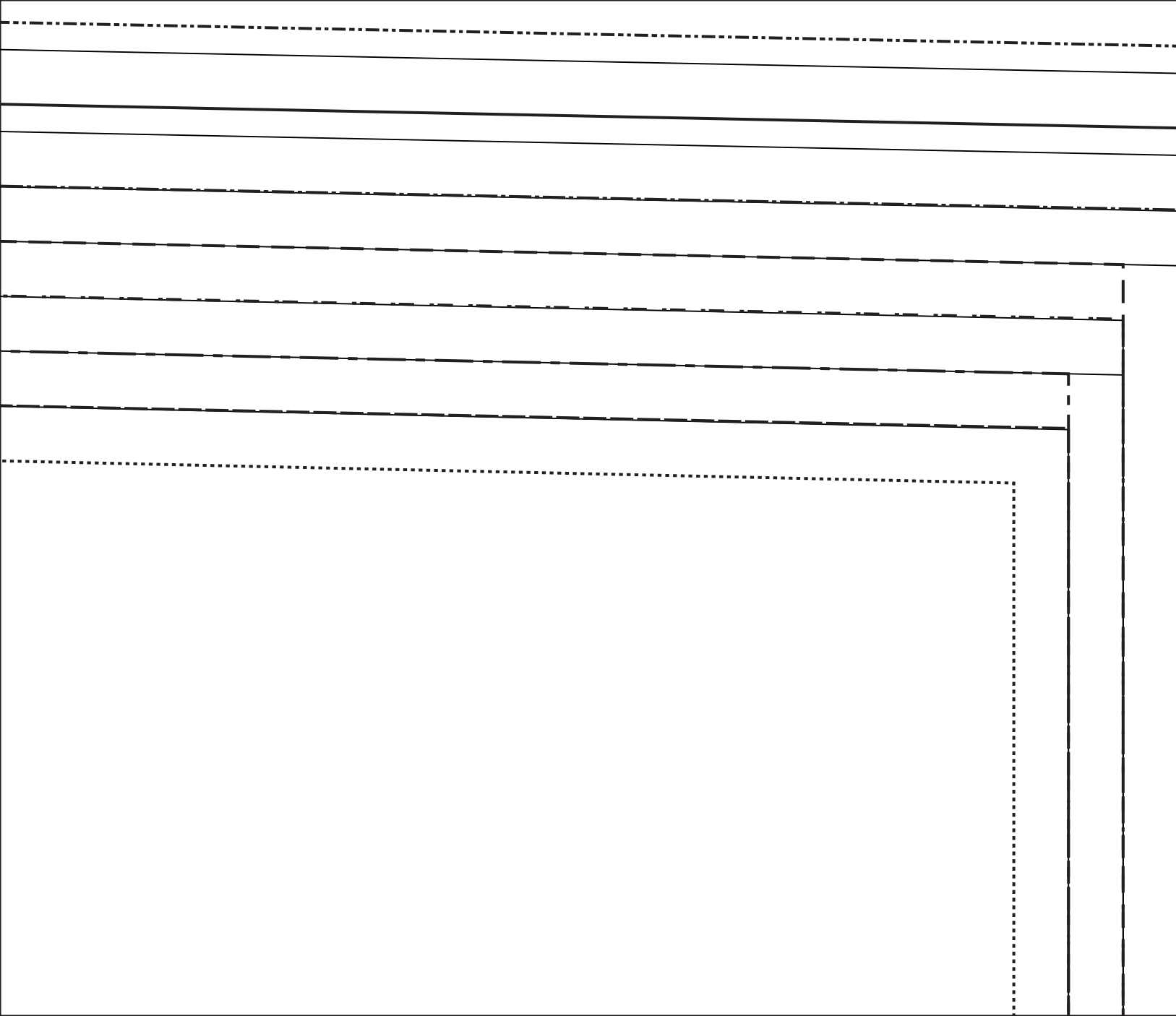

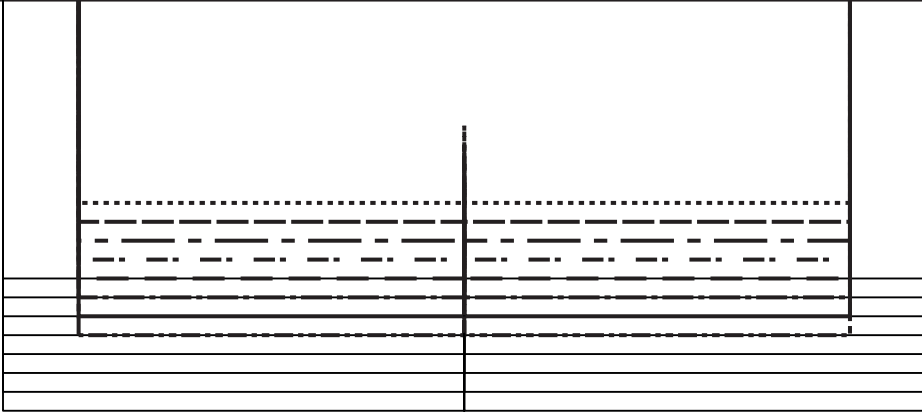

MV/MDV/CF/YM

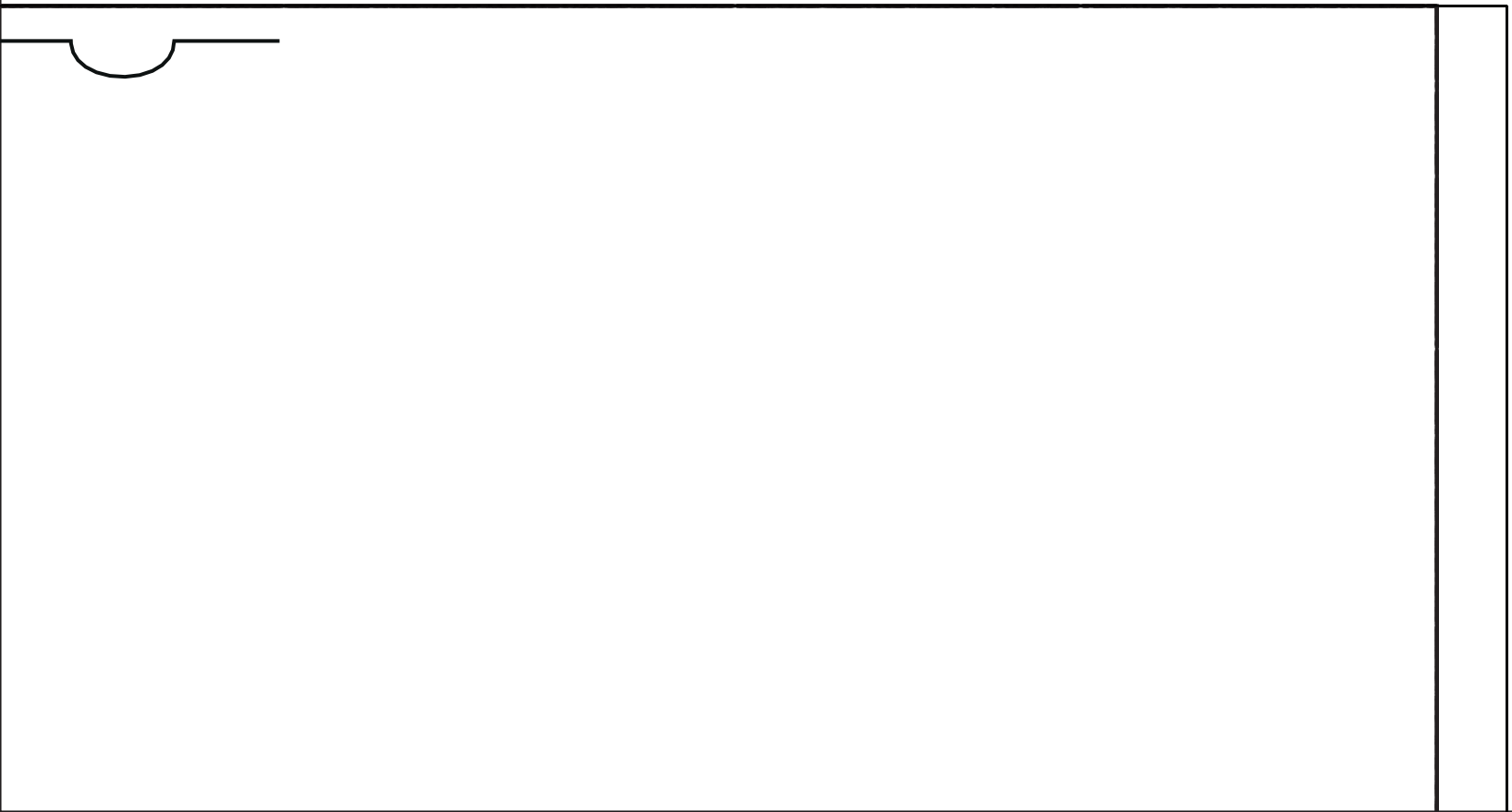
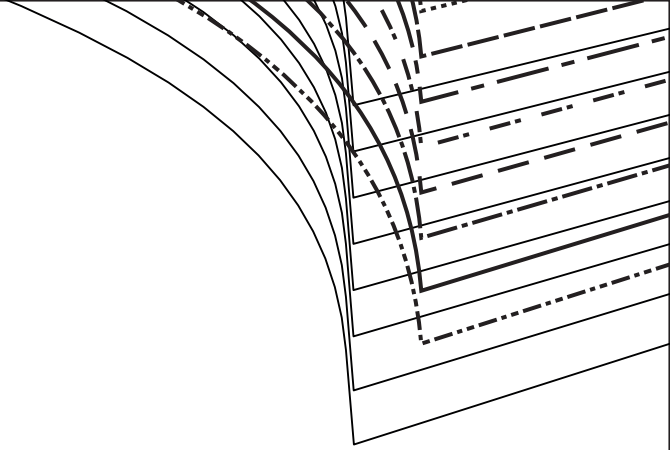

MR/MDS/CB/RM
MV/MDV/CF/VM



E

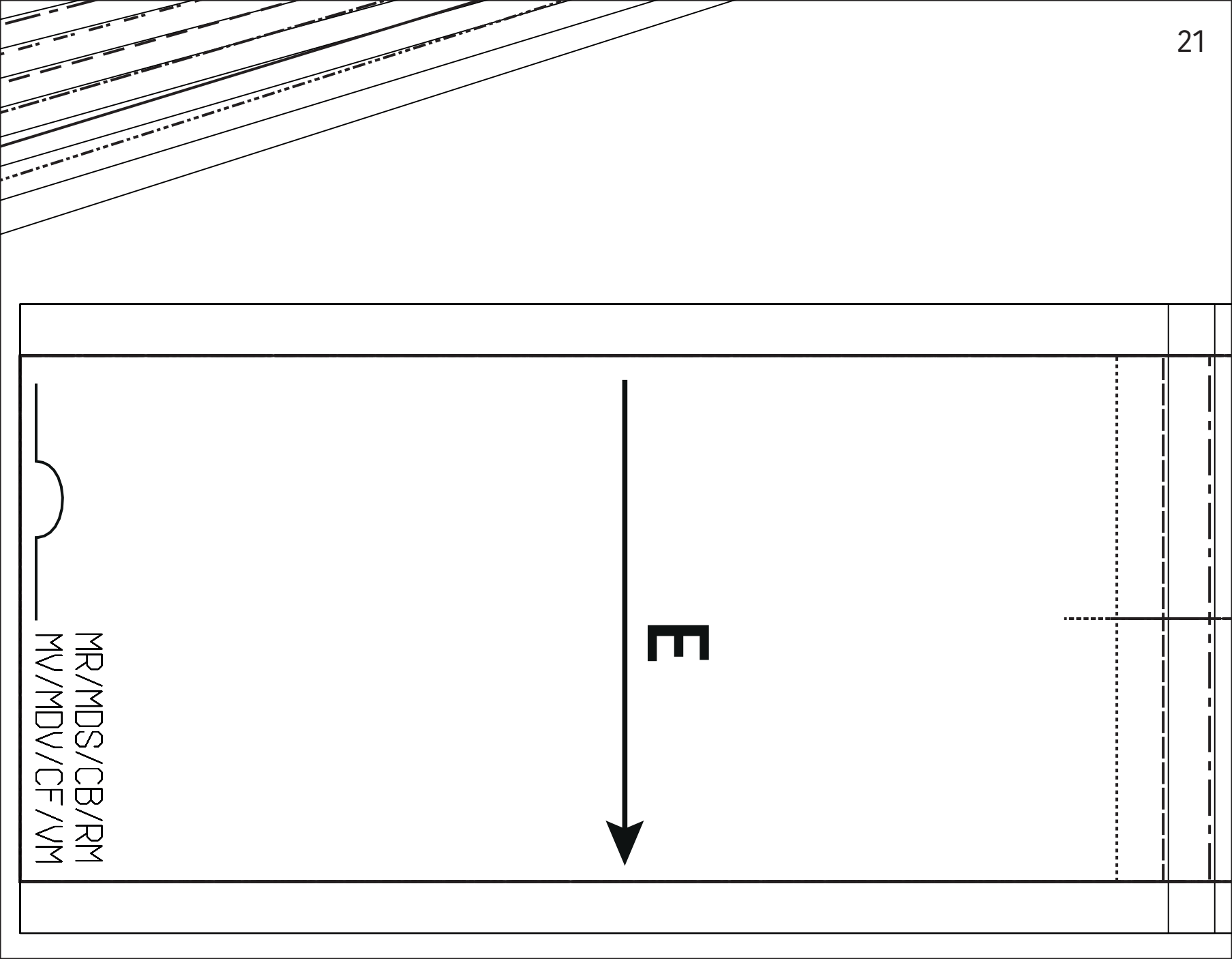

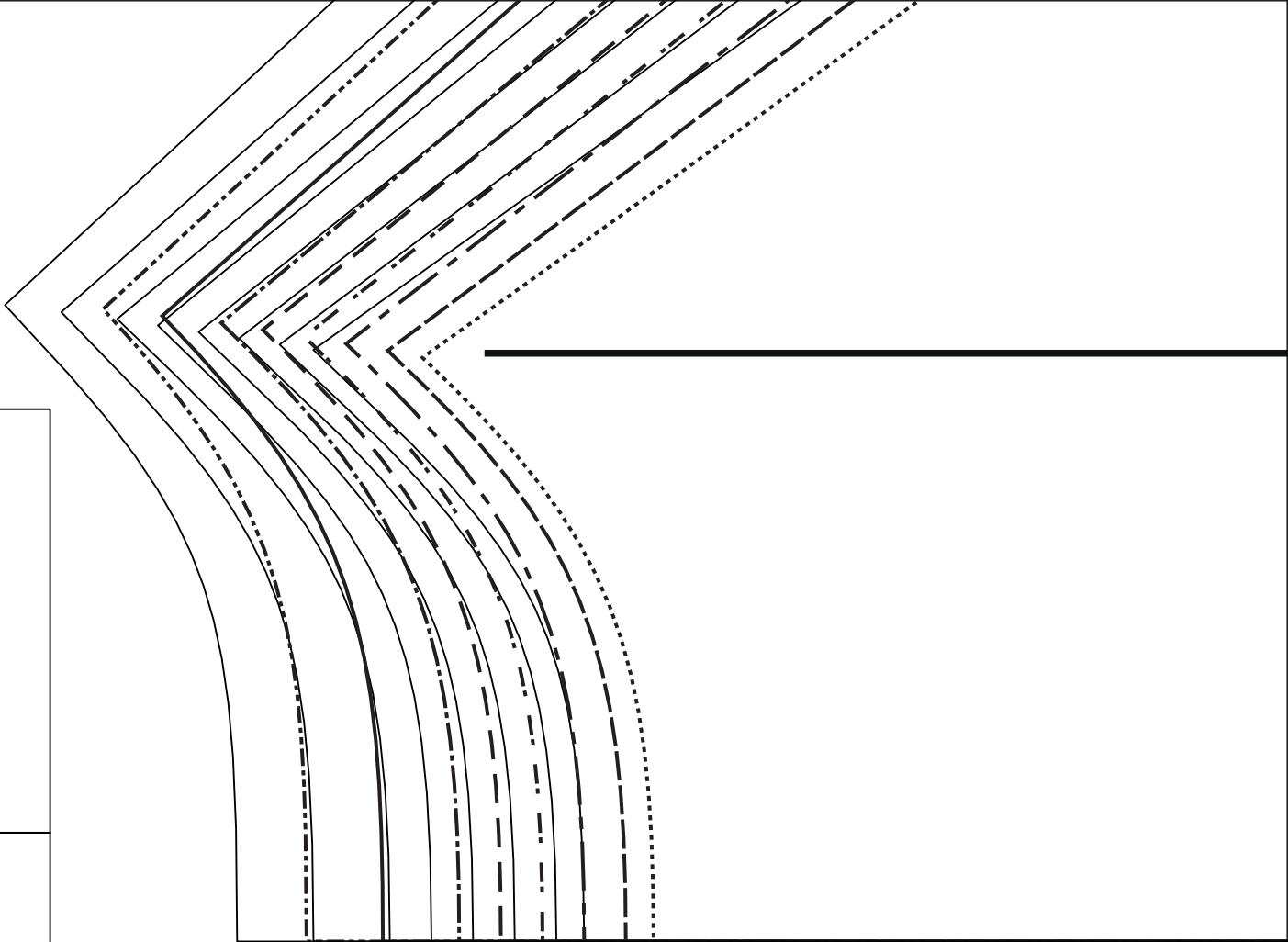

A



MV/MDV/CF/



VM

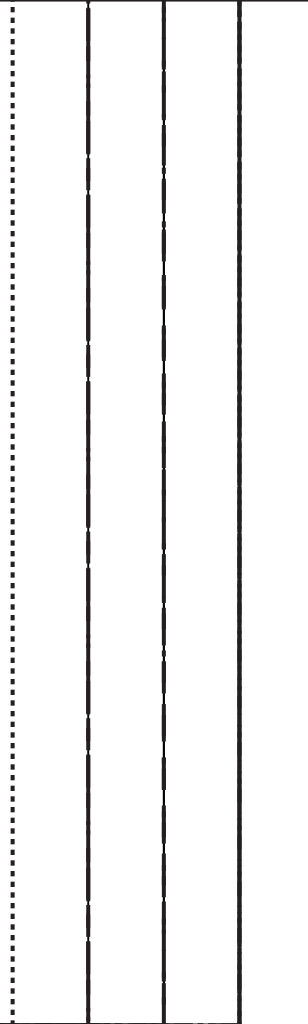

25



D

