

Aida

Jurk / Robe / Dress / Kleid

Patroondelen / Pièces du patron / Pattern pieces / Schnittteile:

- A** voorpand top / devant haut / top
front panel / Vorderteil Top
- B** voorpand rok / devant jupe / skirt FP /
Vorderteil Rock
- C** rugpand / dos / back panel /
Rückenteil
- D** beleg RP / parementure dos /
facing BP / Besatz RT
- E** zak / poche / pocket / Tasche

Patroonschema / Schéma du Patron / Pattern Diagram / Übersichtsplan zum Zusammenkleben

1	2	3	4	5	6
7	8	9	10	11	12
13	14	15	16	17	18
19	20	21	22	23	24
25	26	27	28	29	30
31	32	33	34	35	36
37	38	39	40	41	42

Controlevierkant / Carré de controle / Test square / Kontrollquadrat

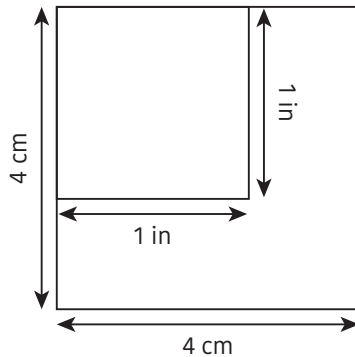

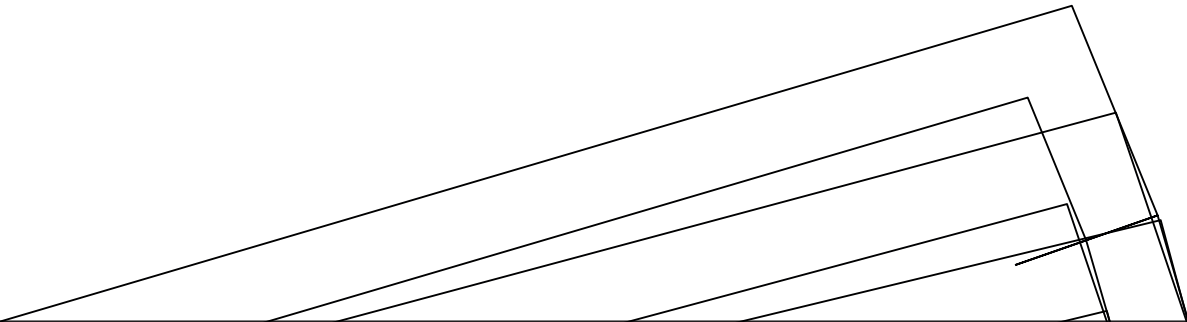
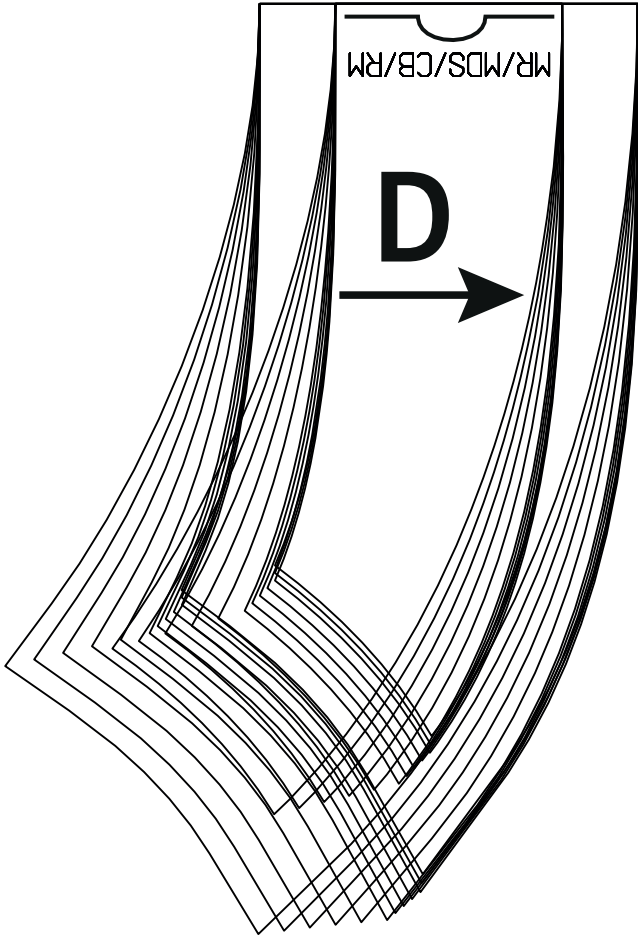

3

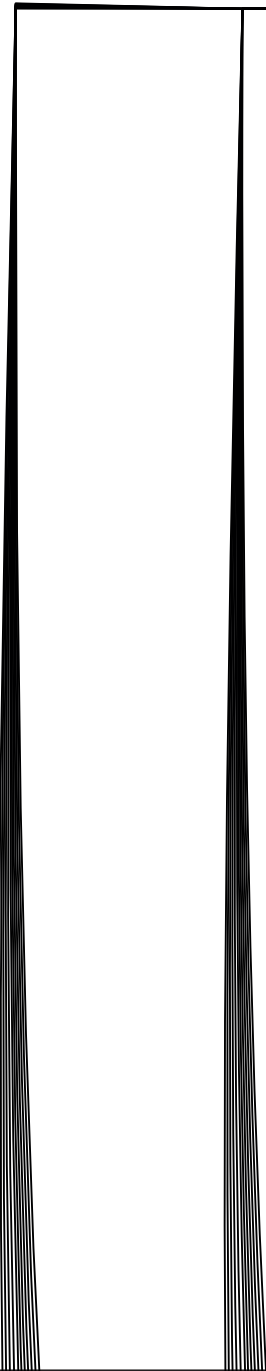

MV/MDV/CF/VM

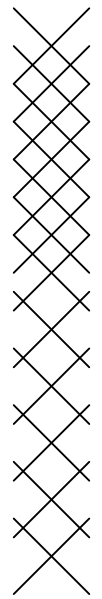

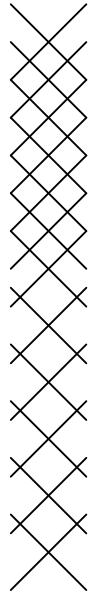

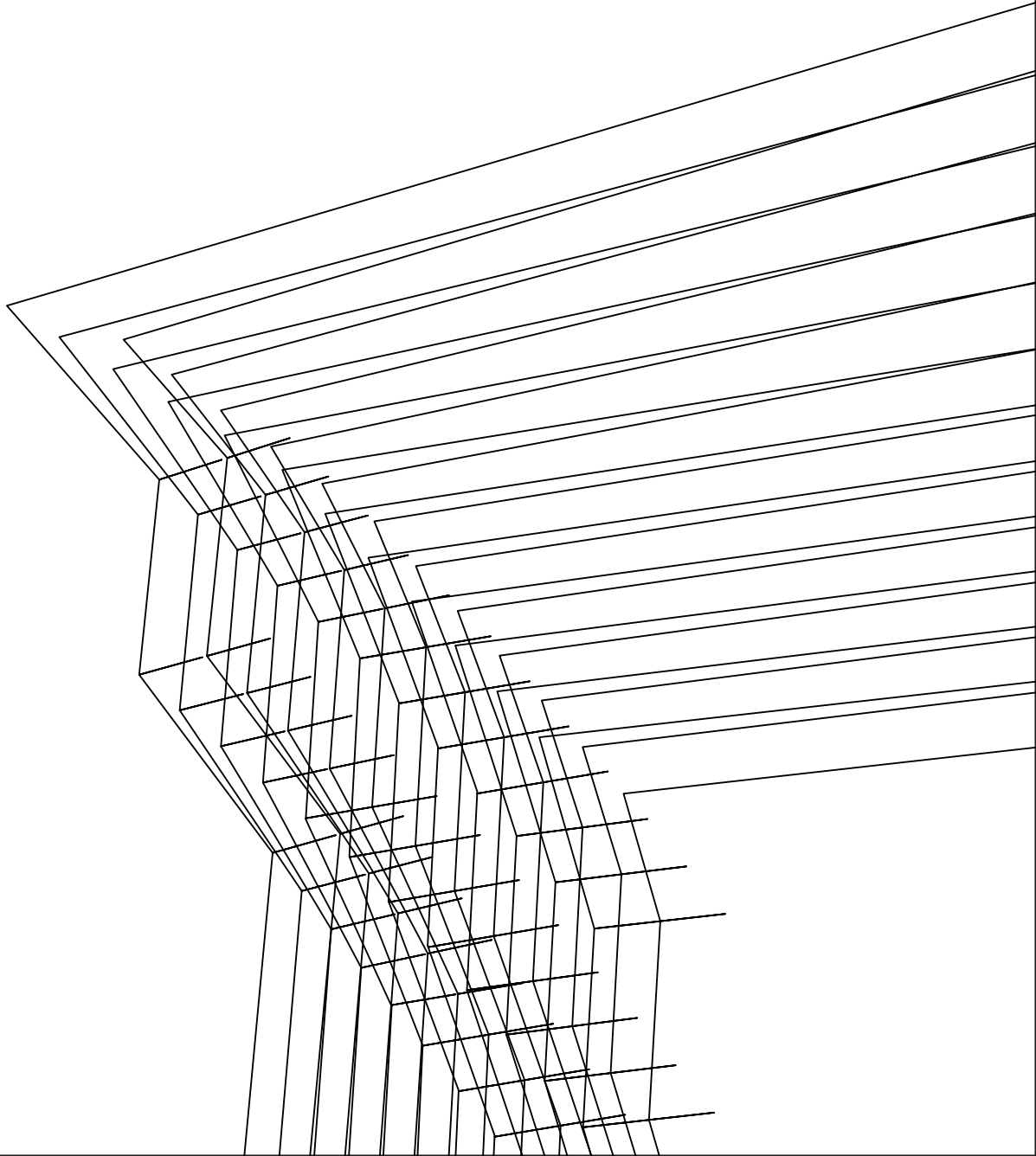

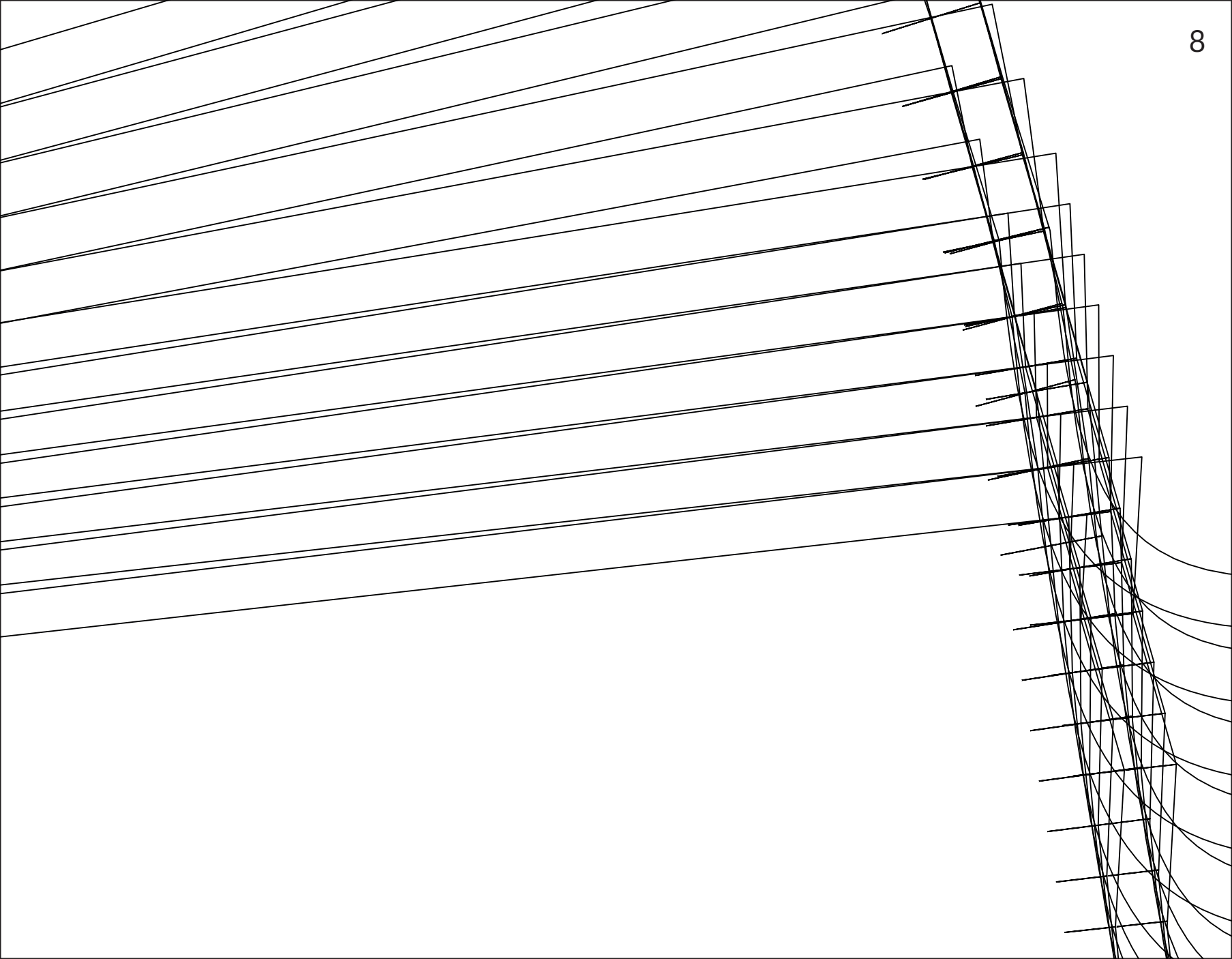

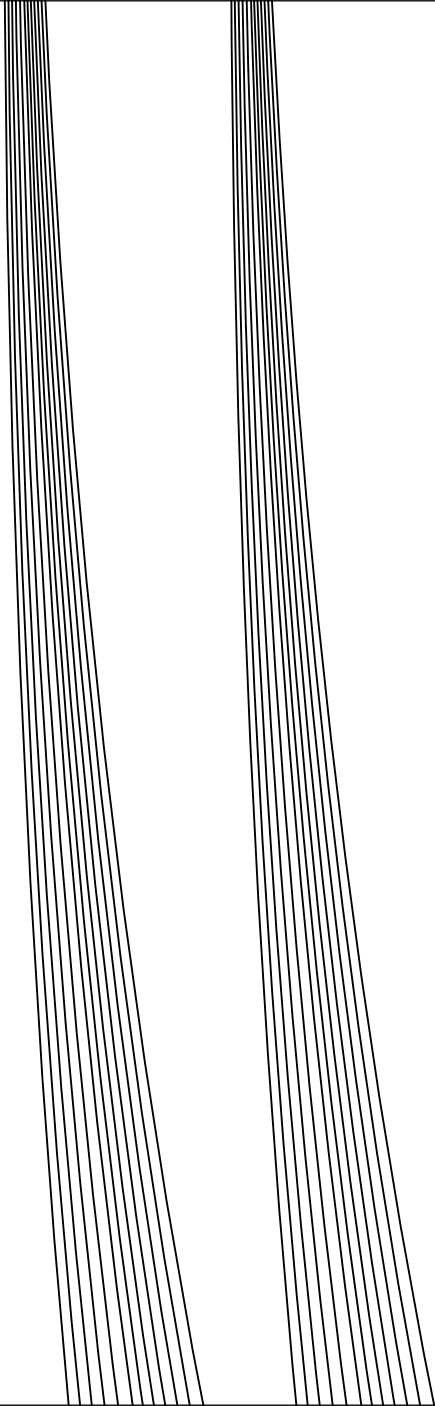
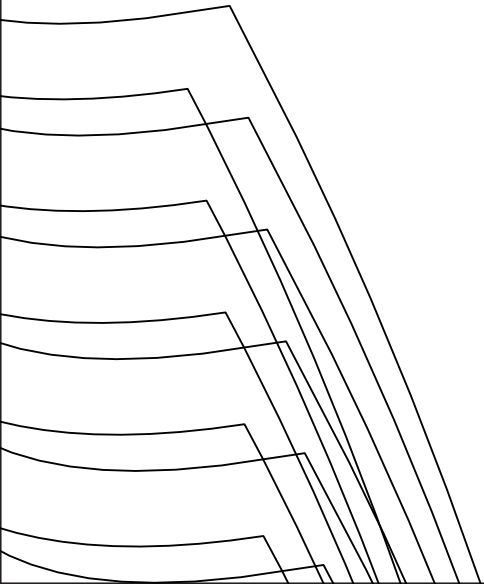

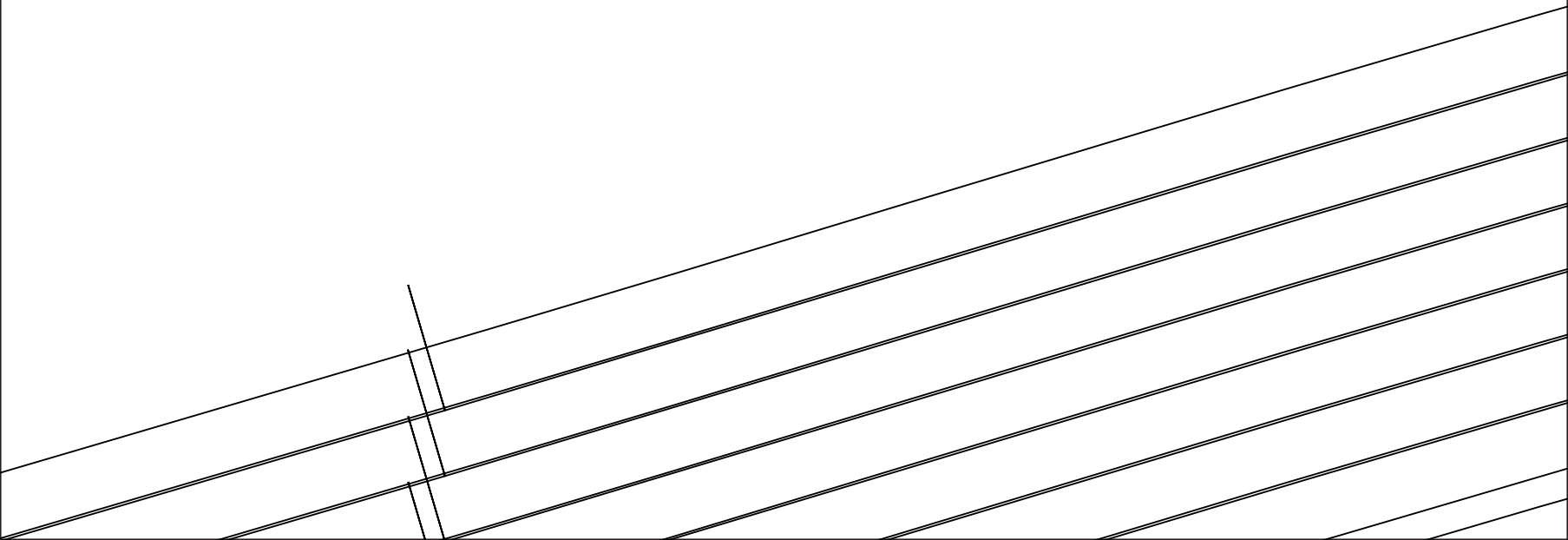

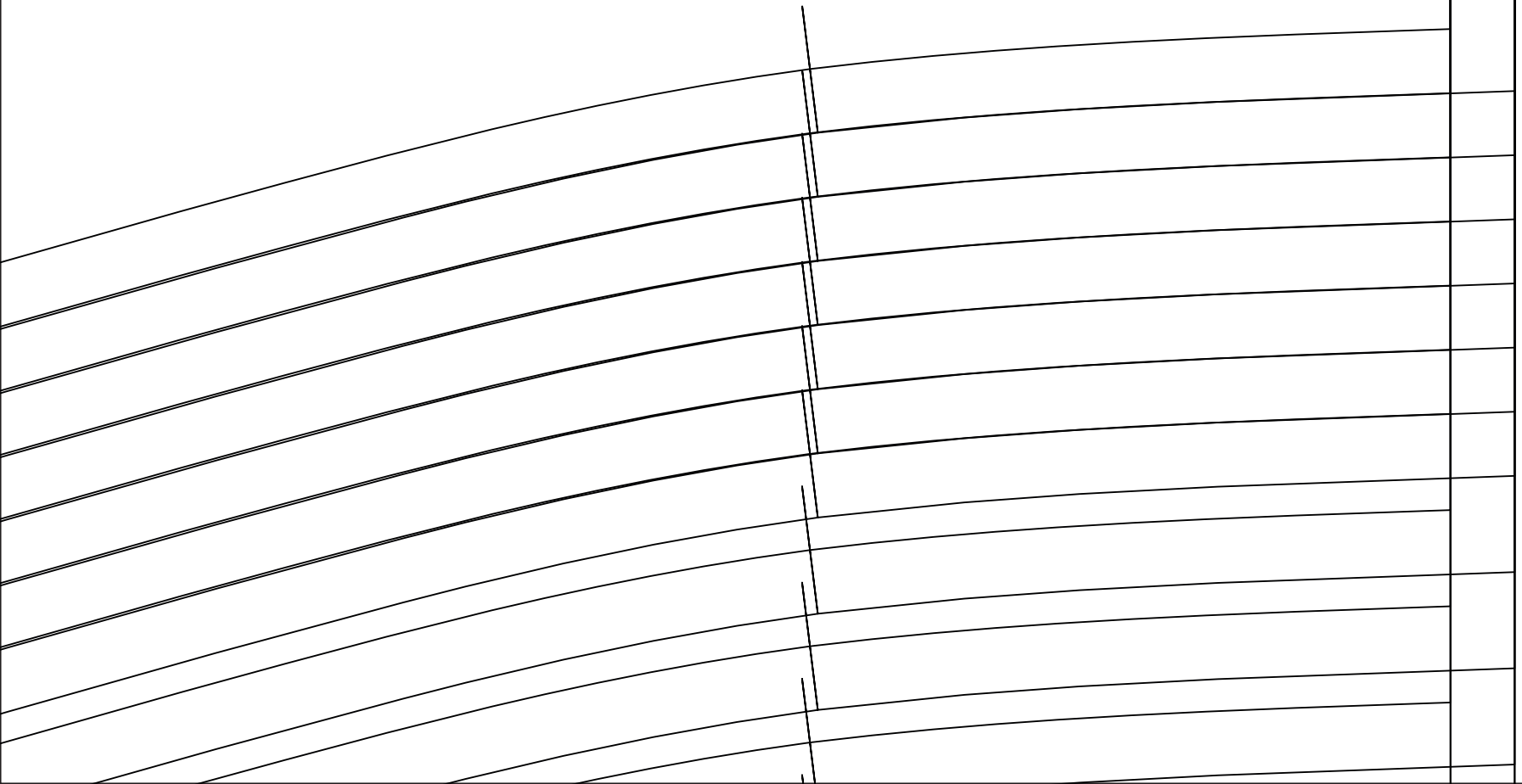

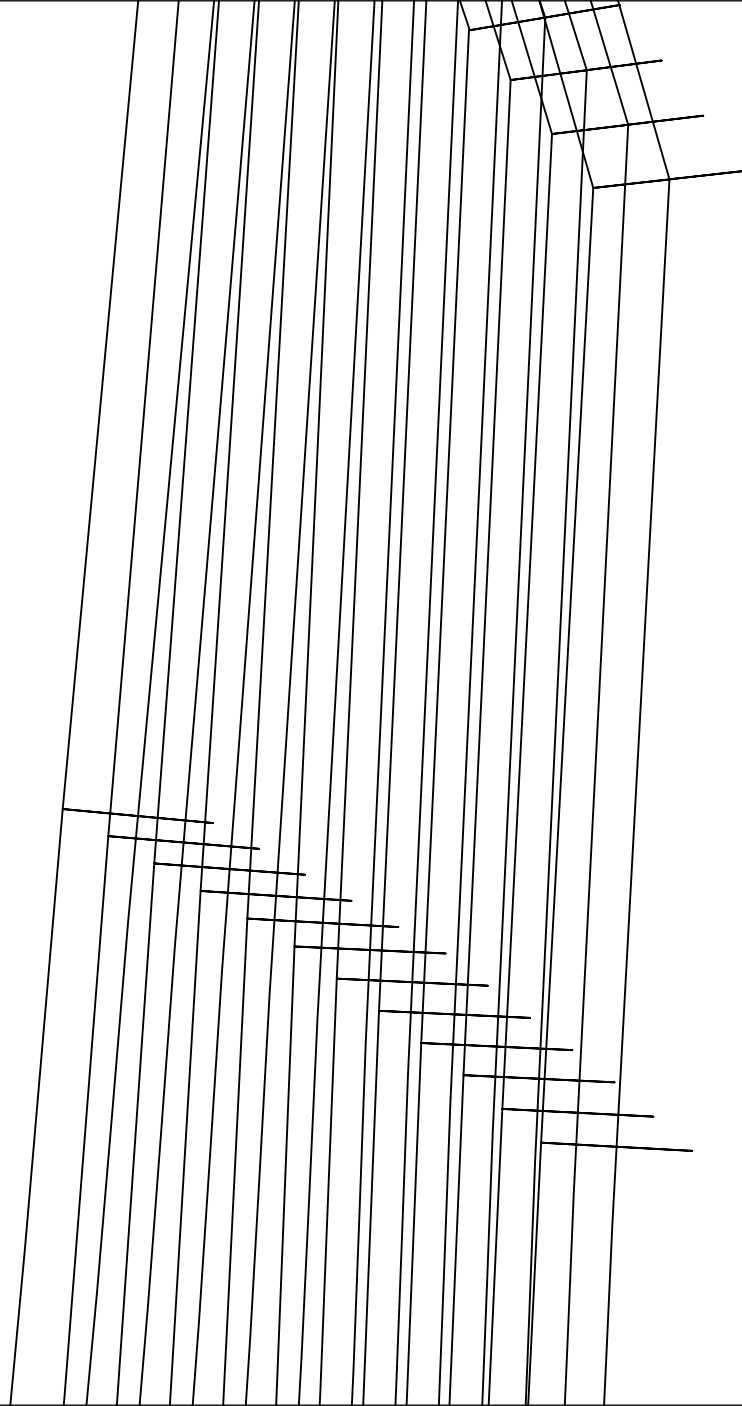



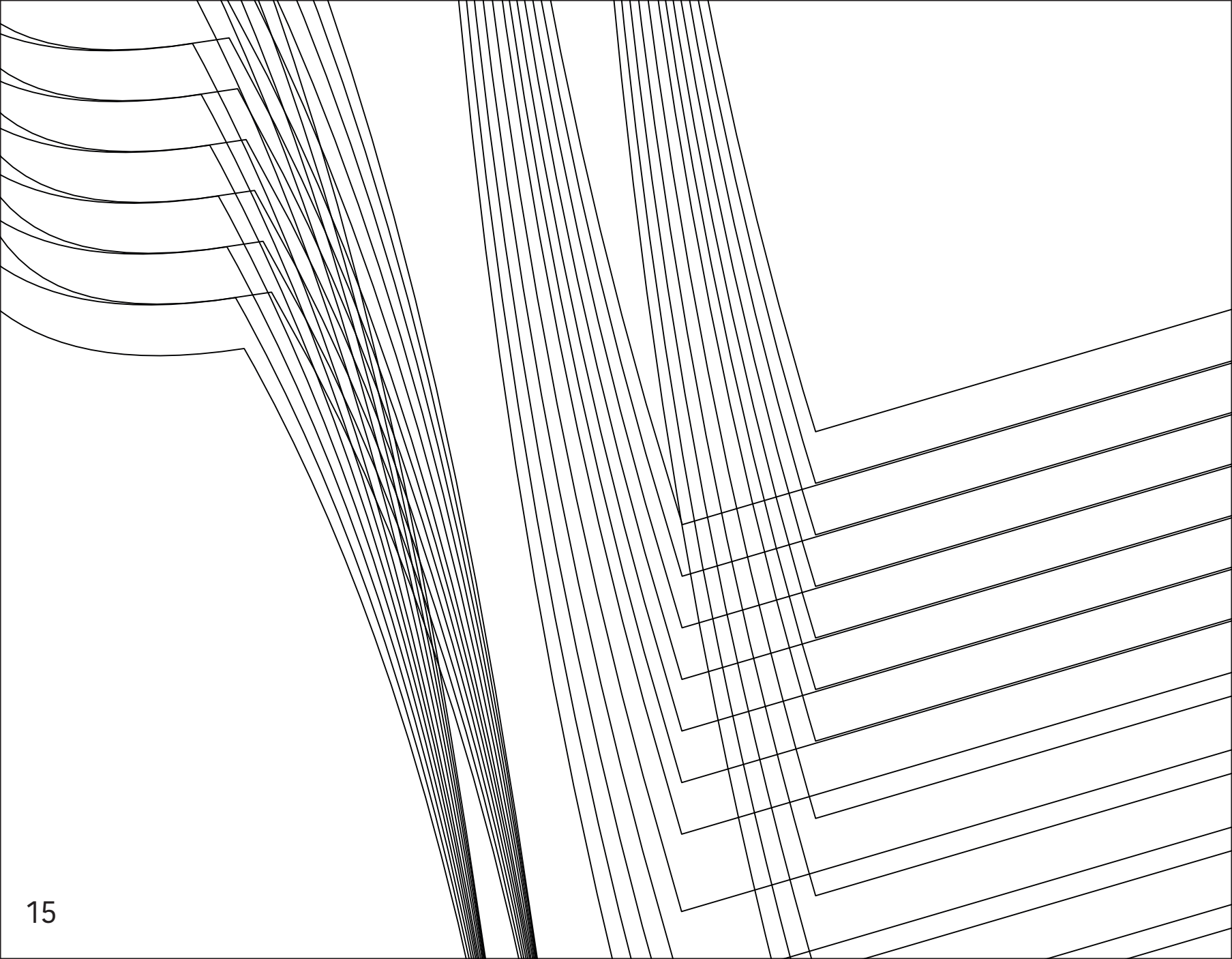

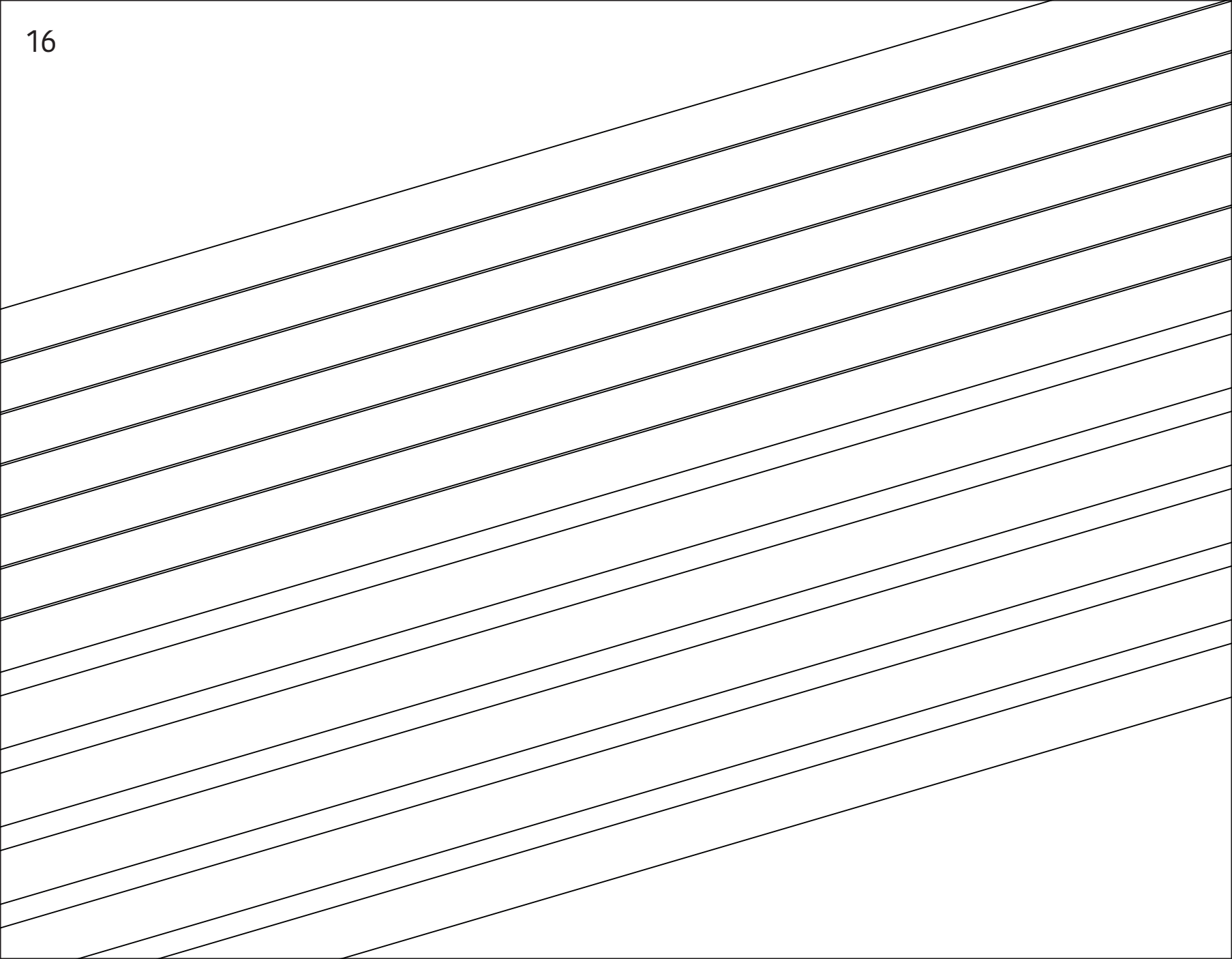

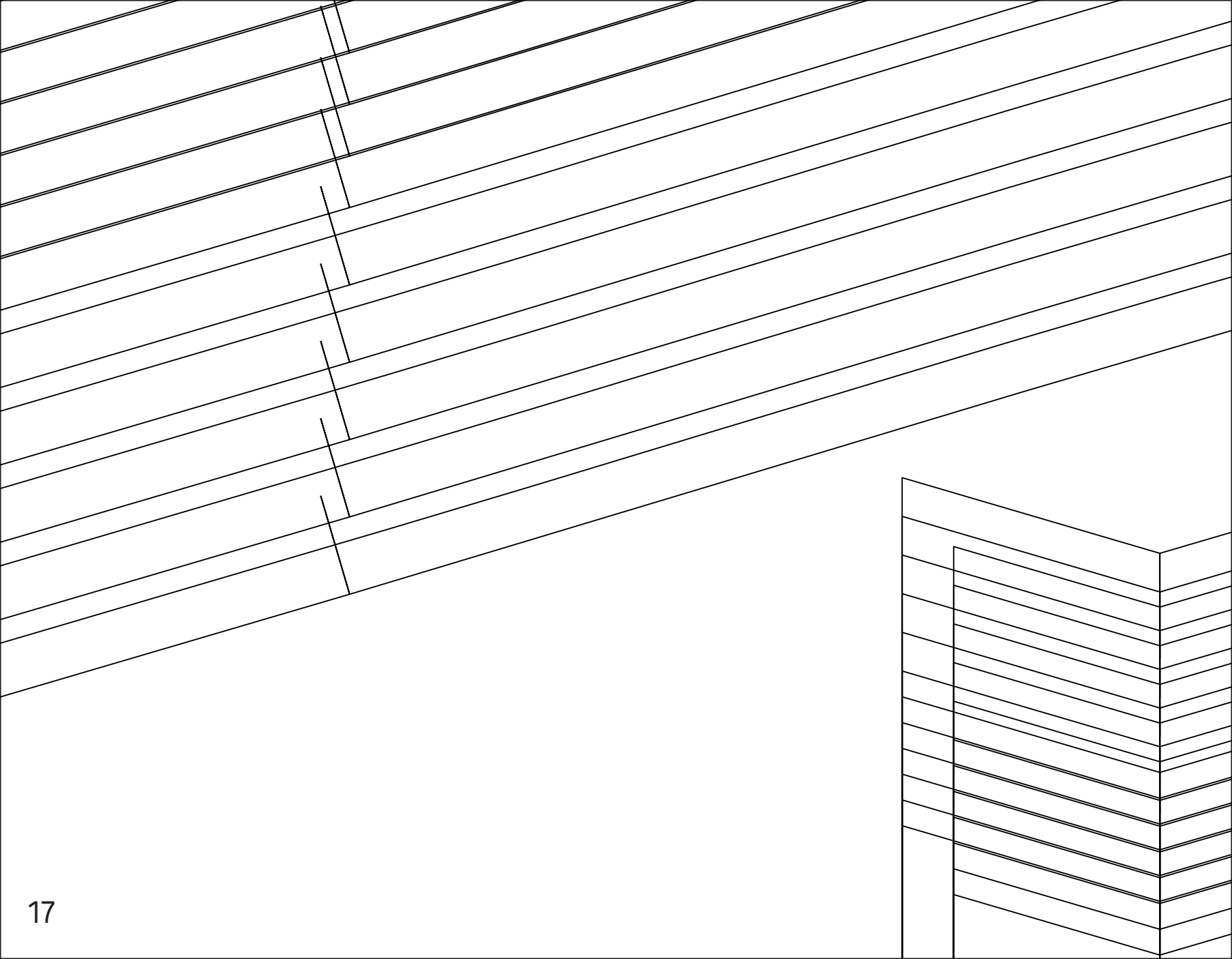

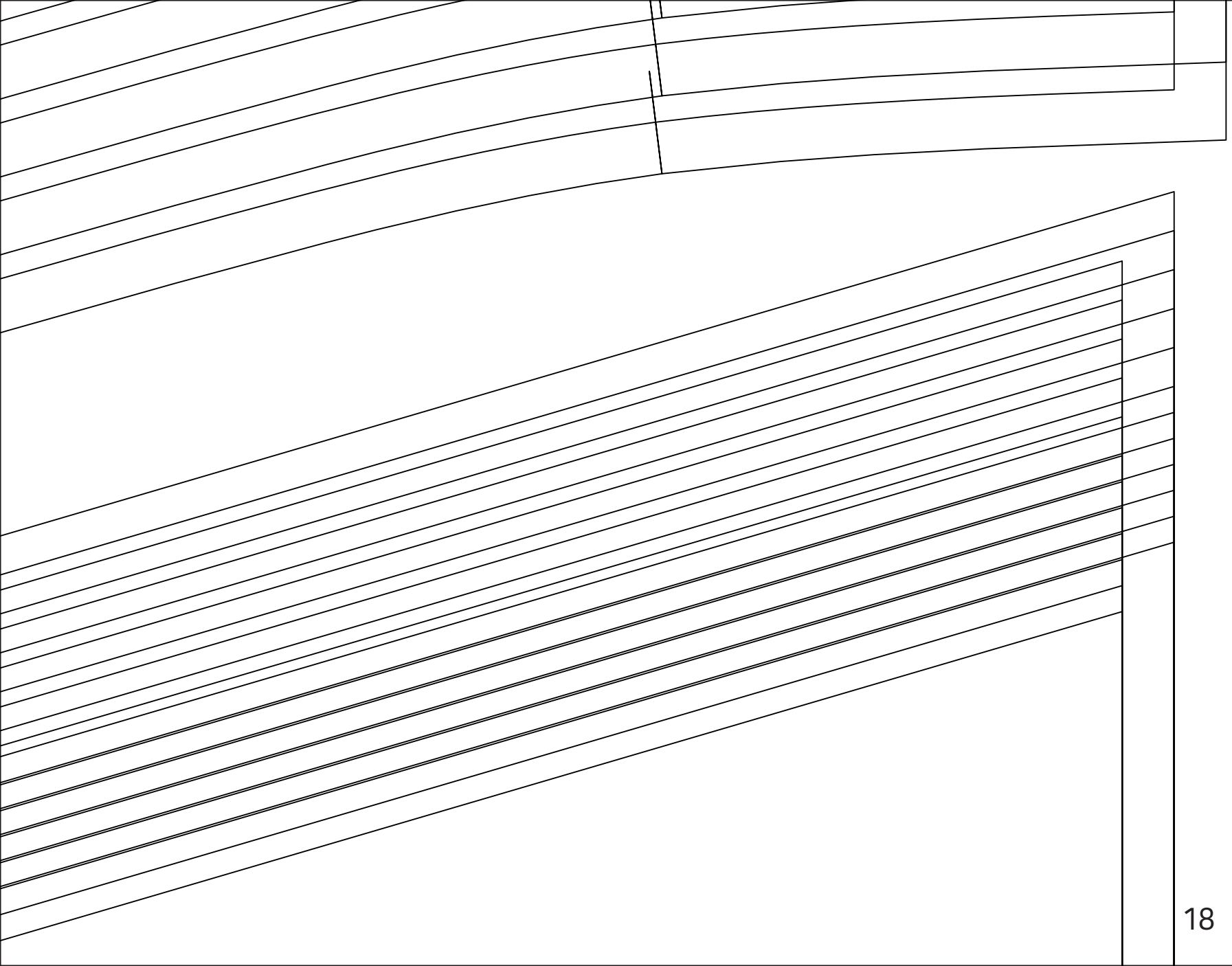

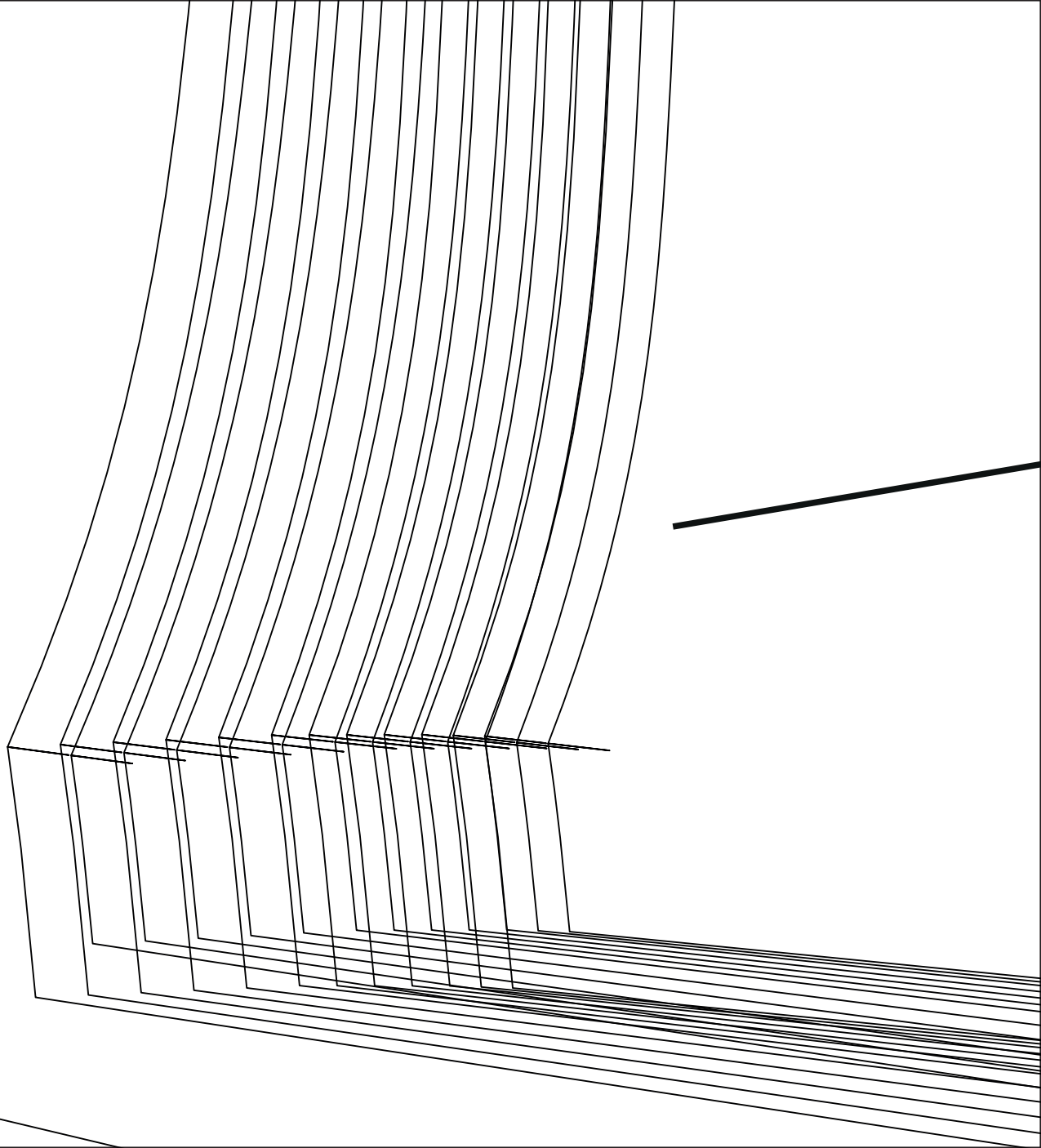

A

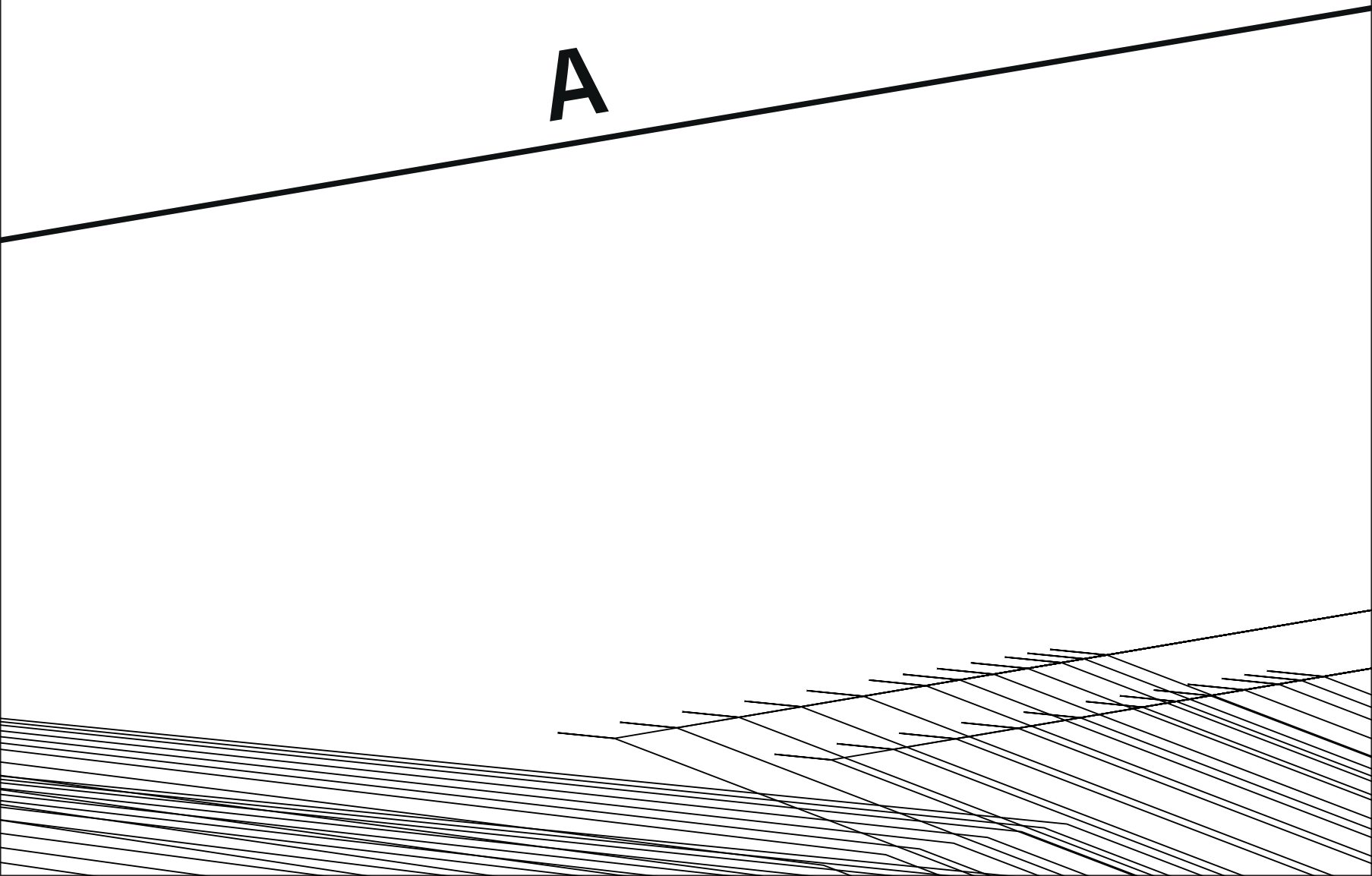



MV/MDV/CF/VM

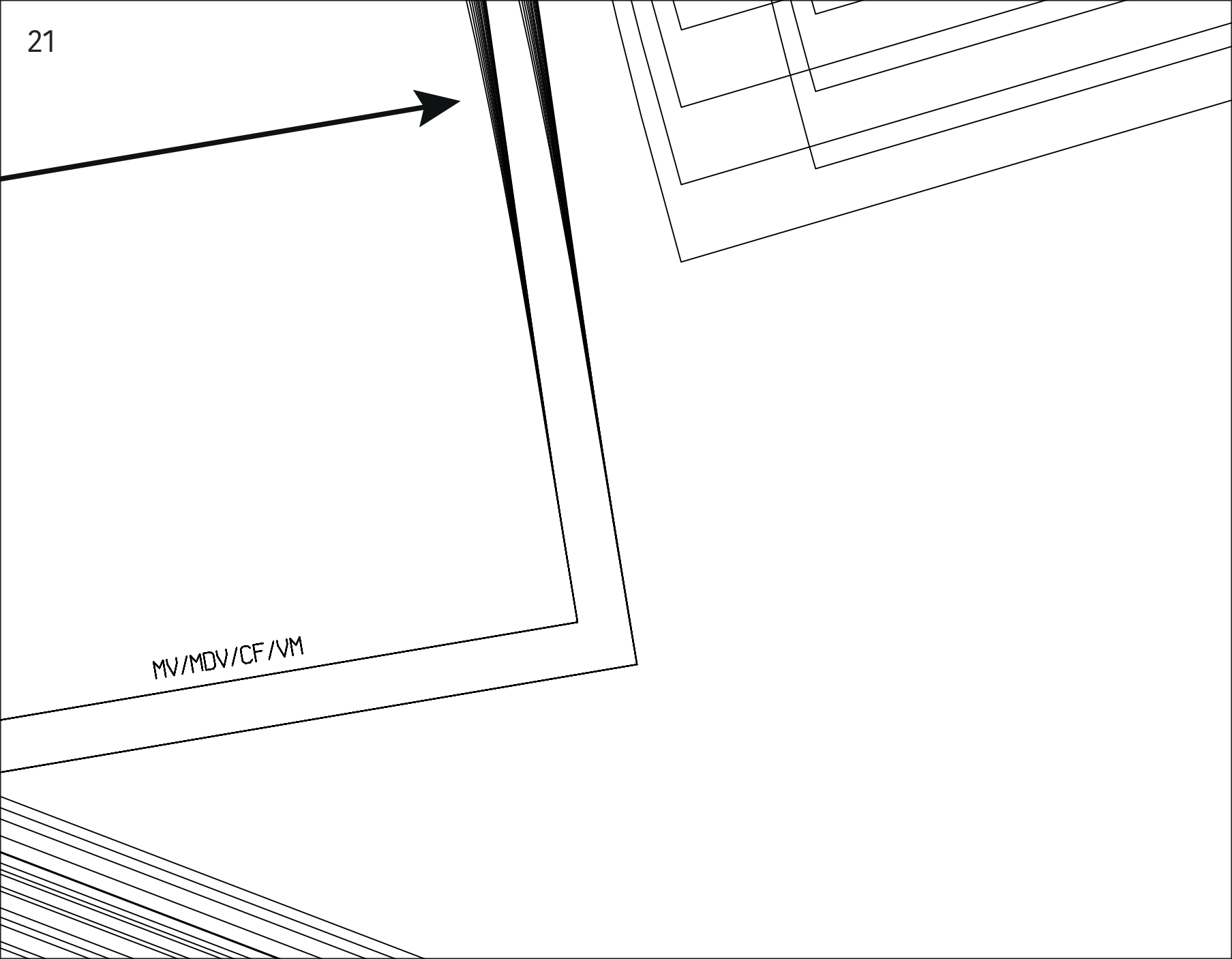



E



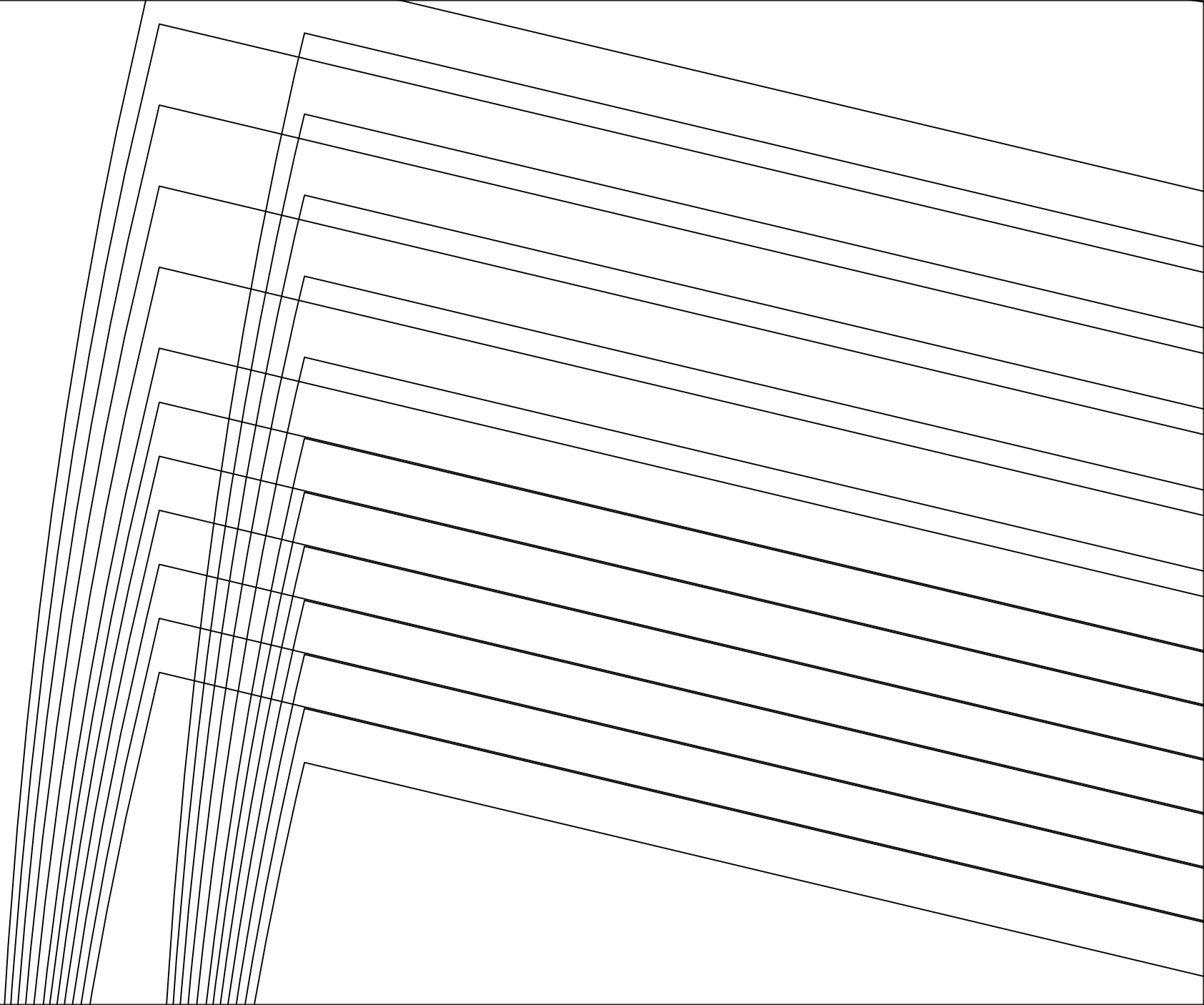

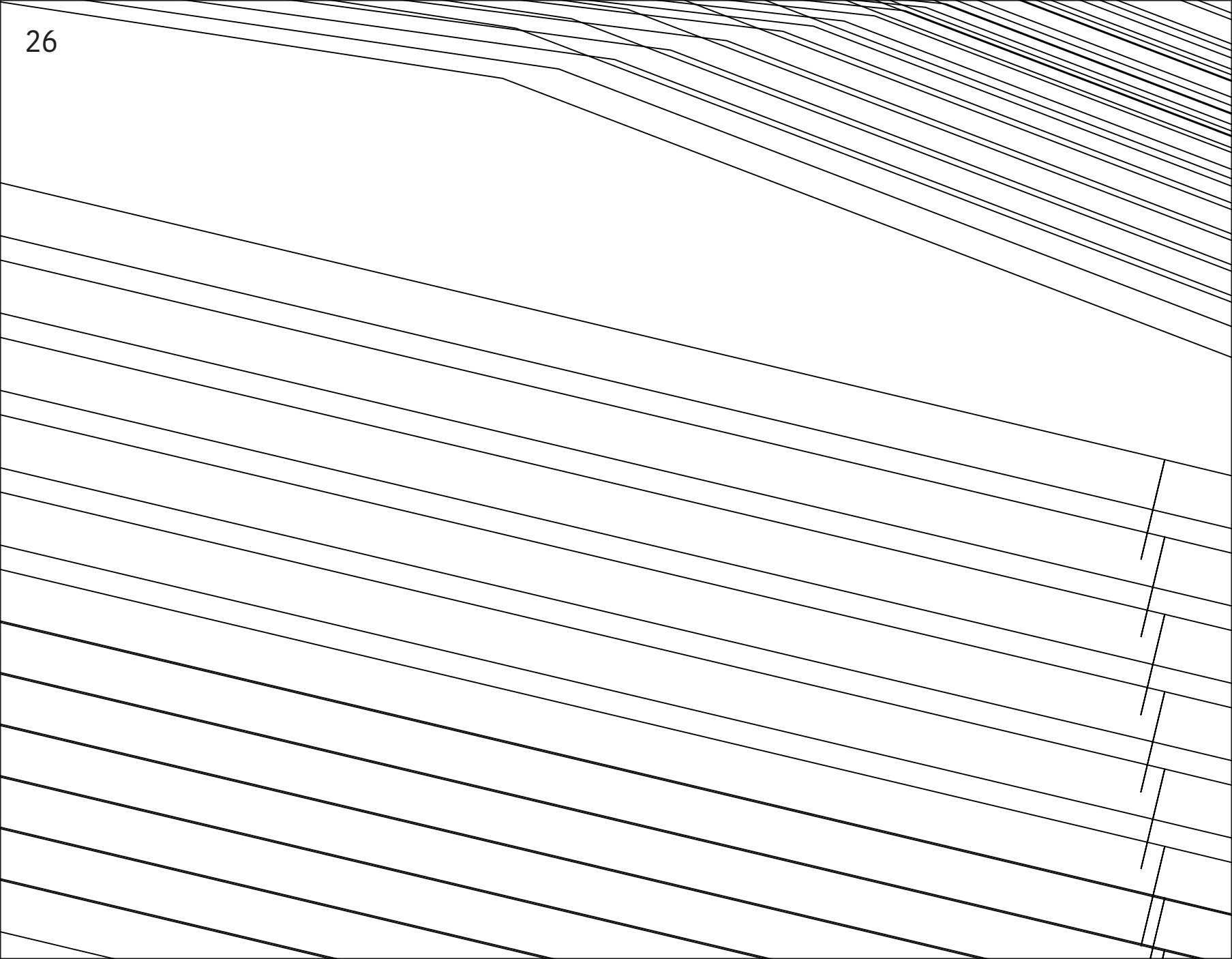

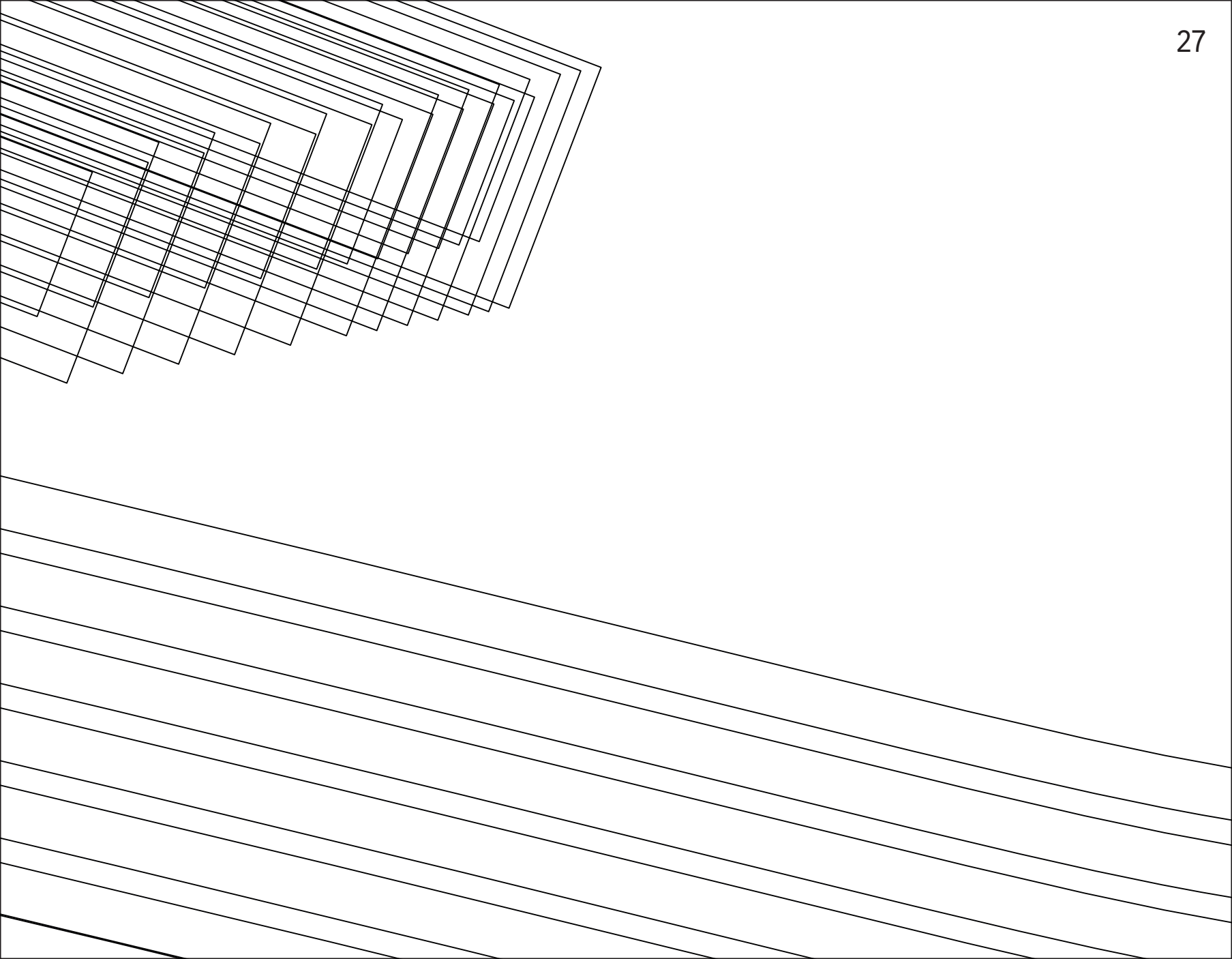

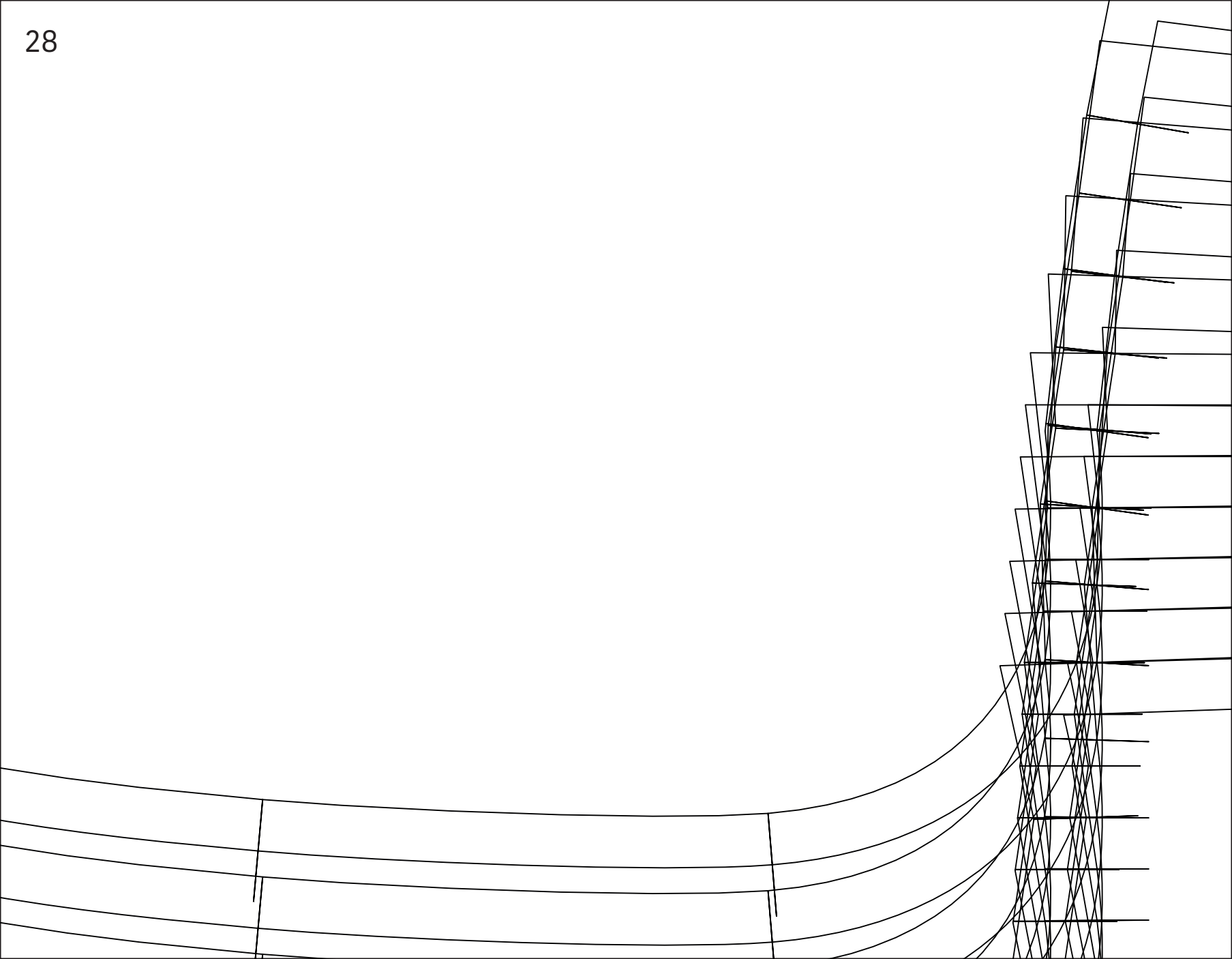

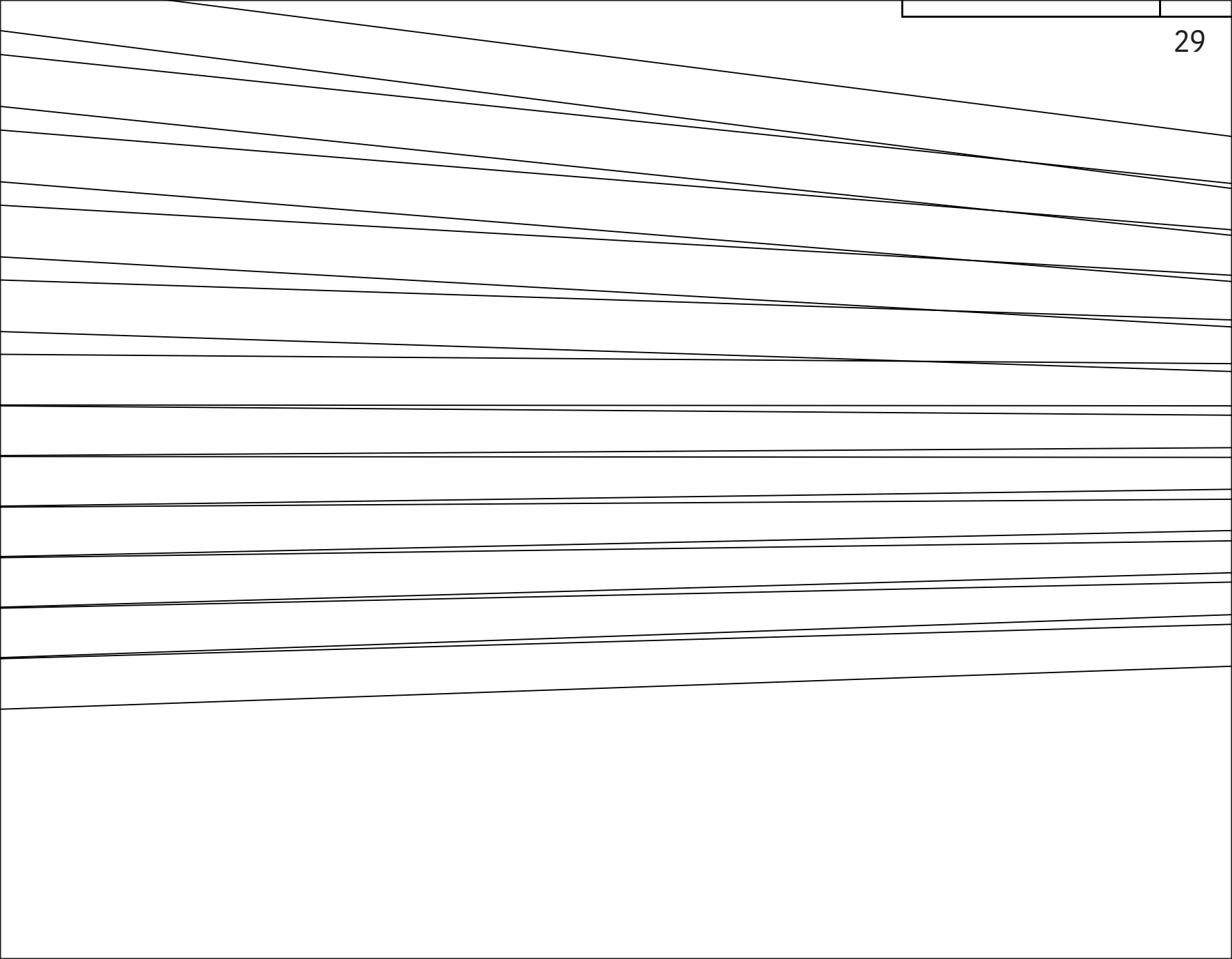

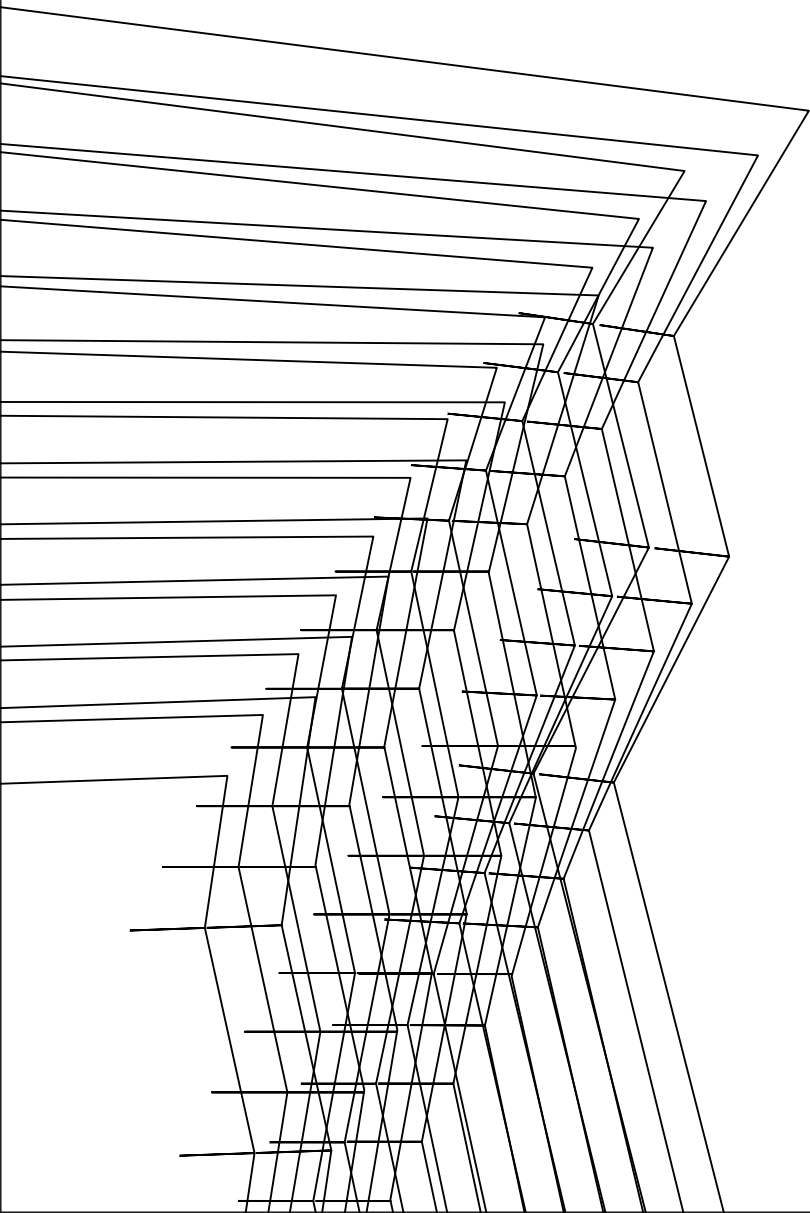

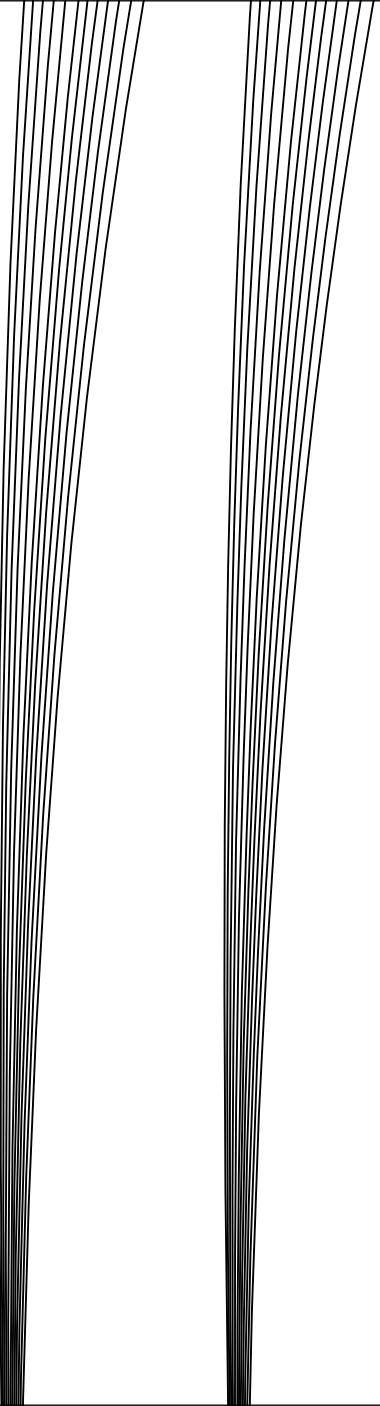

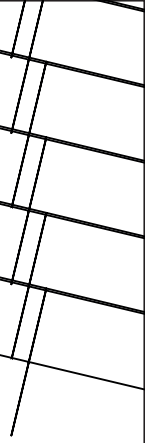

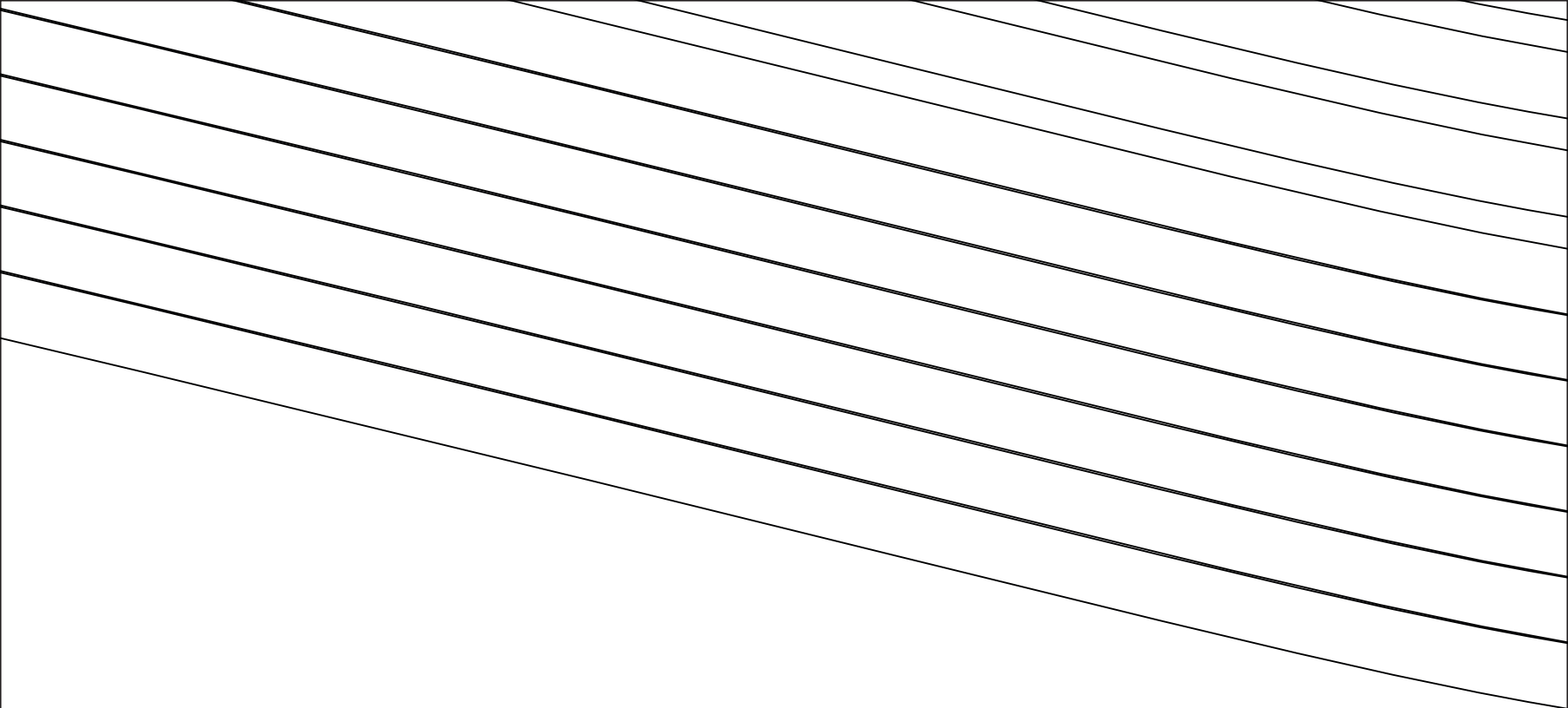

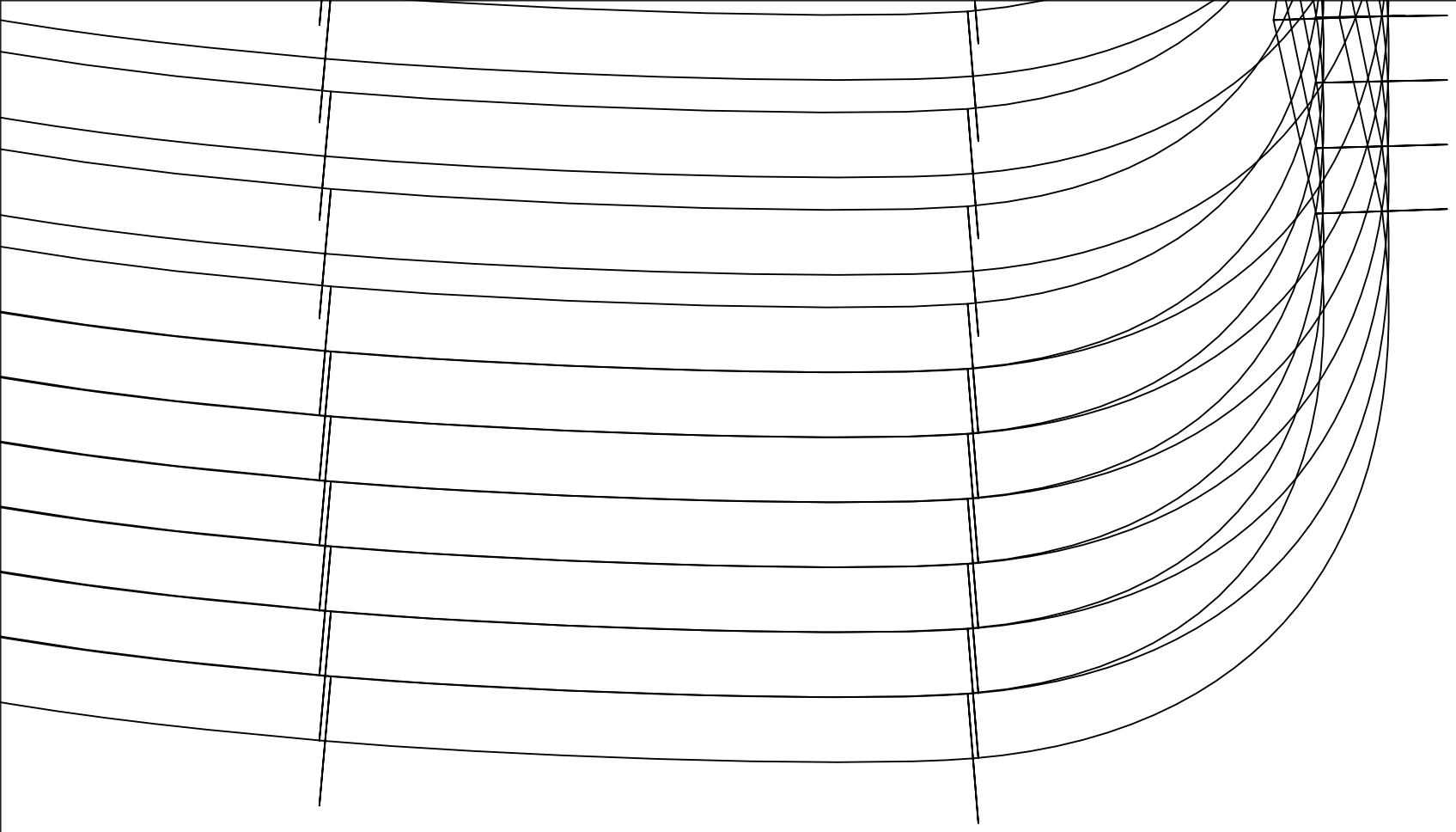

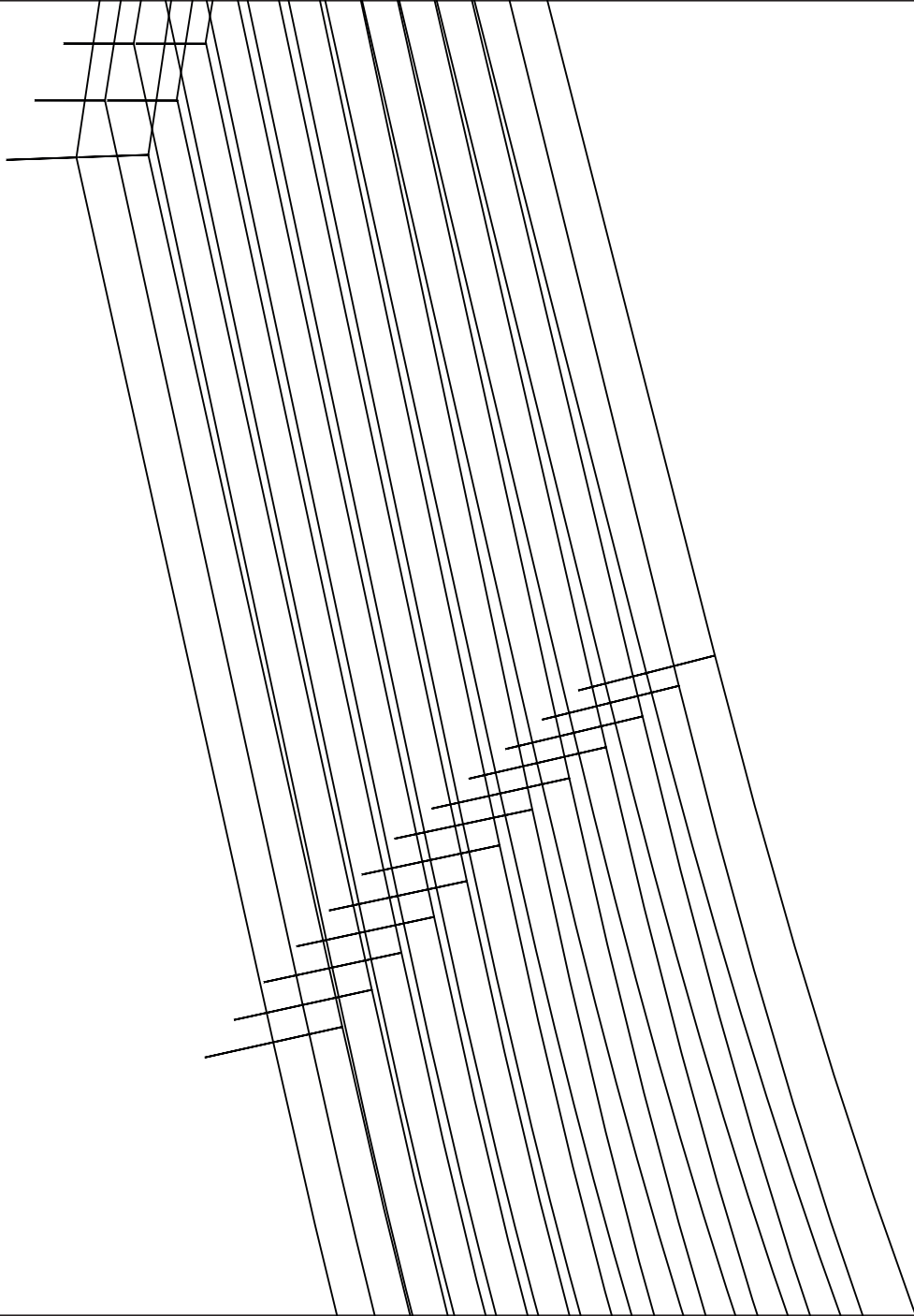



40

3



